

Valve terminals type 34 MPA-L

FESTO



Valve terminals type 34 MPA-L

Key features

FESTO

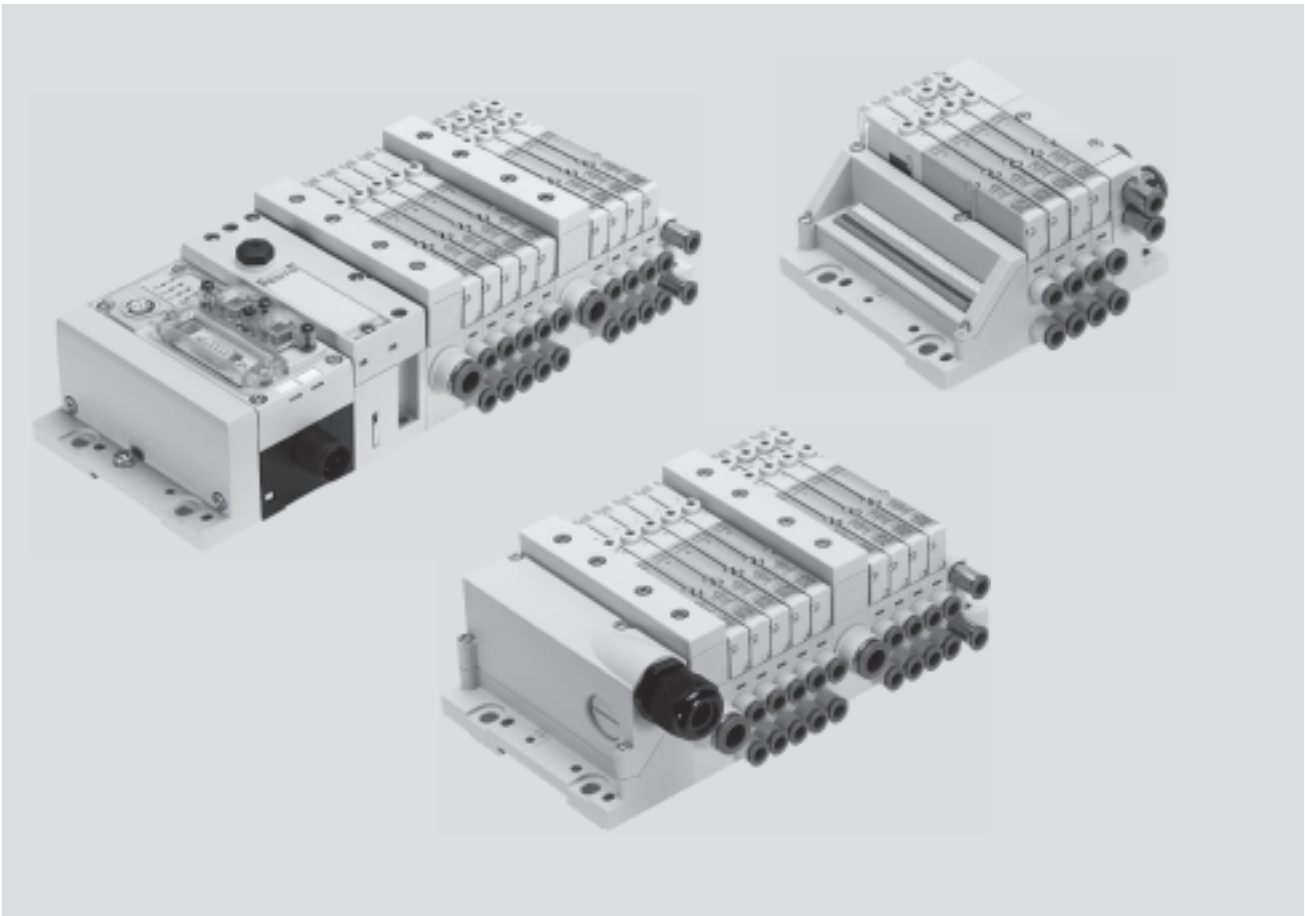

Innovative

- Slim high-performance valves in a sturdy metal housing
- Flow rates up to 360 l/min
- Wide range of electrical connection options for multi-pin plug: Sub-D, flat cable or terminal strip
- Connection to the electrical peripherals CPX with a wide range of communication options
- Freely configurable push-in connectors

Versatile

- Modular system offering a range of configuration options
- Freely extendable system with individual sub-bases and modular tie rods
- Up to 32 solenoid coils
- Conversions and extensions possible at a later date
- Air supply can be extended by additional pressure zones via supply modules
- Wide range of pressures –0.9 ... 10 bar
- Wide range of valve functions

Reliable

- High output reserves thanks to large pneumatic cross sections and venting with high flow rates
- Resilient thanks to high mechanical rigidity
- Lightweight and low-cost polymer components
- Fast troubleshooting thanks to LEDs on the valves
- Easy to service thanks to replaceable valves and electronic modules
- Manual override either non-detenting, detenting or secured against unauthorised activation (covered)
- Durable thanks to tried-and-tested piston spool valves

Easy to assemble

- Fast and reliable in-house assembly using individual components or delivered as a ready-to-install and tested unit
- Lower selection, ordering, installation and commissioning costs
- Secure mounting on wall or H-rail

Valve terminals type 34 MPA-L

Key features

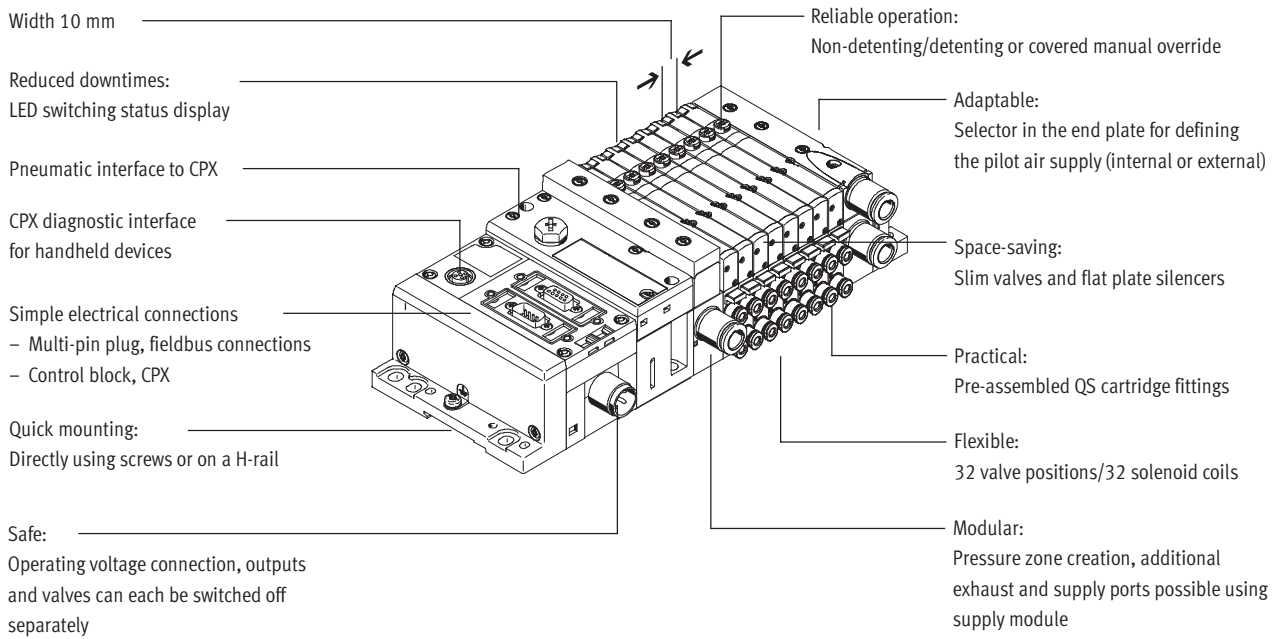

Equipment options

Valve functions

- | | | | |
|--|--|---|---|
| <ul style="list-style-type: none"> • 5/2-way valve, single solenoid • 5/2-way valve, double solenoid • 2x 3/2-way valve, normally open • 2x 3/2-way valve, normally closed • 2x 3/2-way valve, 1x normally open, 1x normally closed | <ul style="list-style-type: none"> • 5/3-way valve, mid-position pressurised • 5/3-way valve, mid-position closed • 5/3-way valve, mid-position exhausted • 2x 2/2-way valve, 1x normally closed, 1x normally closed, reversible | <ul style="list-style-type: none"> • 2x 2/2-way valve, normally closed • 1x 3/2-way valve, normally closed, external compressed air supply • 1x 3/2-way valve, normally open, external compressed air supply | <p>All valves have the same compact dimensions with an overall length of 107 mm and a width of 10.5 mm.</p> |
|--|--|---|---|

Special features

- | | | | |
|---|---|---|--|
| <ul style="list-style-type: none"> • Max. 32 valve positions/ max. 32 solenoid coils • Parallel, modular valve linking • Electrical interlinking with integrated holding current reduction | <ul style="list-style-type: none"> • Any compressed air supply (max. 8 supply modules) | <ul style="list-style-type: none"> • Creation of pressure zones • Modular, individually extendable tie rods • Single valves or combinations of four valves | <ul style="list-style-type: none"> • Tubing size at each connection freely selectable |
|---|---|---|--|

Valve terminal selection

Valve terminal configurator Online via: → www.festo.com

<p>The appropriate MPA-L valve terminal can be chosen quickly and easily using the online catalogue. This includes a convenient valve terminal configurator, which makes it much simpler to order the right product.</p>	<p>The valve terminals are fully assembled according to your order specification and are individually tested. This reduces assembly and installation time to a minimum.</p>	<p>You order a valve terminal type 34 using the order code.</p> <p>Ordering system for type 34 → Internet: mpal Ordering system for CPX → Internet: cpx</p>	<p>2D/3D CAD data</p> <p>You can request the CAD data for a valve terminal you have configured. To do so, start the product search as described above. Go to the shopping basket and click on the CAD icon (compass). On the next page you can generate a 3D preview or request another data format of your choice by e-mail.</p>
--	---	--	---

Valve terminals type 34 MPA-L

Key features

Multi-pin plug connection

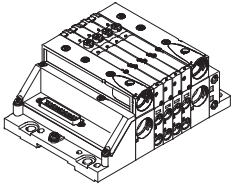

The signal flow from the controller to the valve terminal takes place via a pre-assembled or self-assembled multi-wire cable to the multi-pin plug connection, which substantially reduces installation time.

The valve terminal can be equipped with max. 32 solenoid coils. This corresponds to 2 to 32 valves.

Versions

- Sub-D connection
 - Pre-assembled multi-pin cable
 - Multi-pin cable for self-assembly
- Flat cable connection
- Terminal strip connection

Fieldbus connection via the CPX system

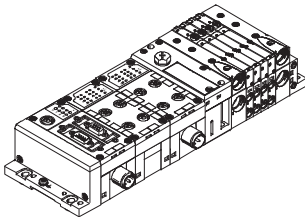

An integrated fieldbus node manages communication with a higher-order PLC. This enables a space-saving pneumatic and electronic solution. Valve terminals with fieldbus interfaces can be configured with up to 32 sub-bases.

The CPX terminal also enables the integration of digital and analogue electrical inputs and outputs, pressure sensors and controllers for pneumatic or electric positioning axes.

A detailed description of the extensive functionality can be found in the documentation for the CPX terminal

➔ Internet: cpx

Fieldbus protocols/CPX variants:

- Profibus DP
- ProfiNet
- Interbus
- DeviceNet
- CANopen
- CC-Link
- Ethernet/IP
- Front End Controller Remote I/O
- Modbus/TCP
- EtherCAT

Control block connection via the CPX system

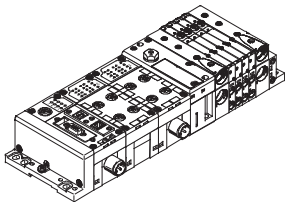

Controllers integrated in the Festo valve terminals enable the construction of stand-alone control units to IP65, without control cabinets.

In the slave operating mode, these valve terminals can be used for intelligent preprocessing and are therefore ideal modules for designing decentralised intelligence.

In the master operating mode, terminal groups can be designed with many options and functions that can autonomously control a medium-sized machine/system.

Valve terminals type 34 MPA-L

Peripherals overview

Modular pneumatic components

The modular design of the MPA-L facilitates maximum flexibility right from the planning stage and offers maximum ease of servicing during operation.

The system consists of sub-bases and valves.

The sub-bases form the support system for the valves. They contain the connection ducts for supplying compressed air to and venting from the valve terminal as well as the working lines for the pneumatic drives for each valve.

The sub-bases are joined together via a tie rod system. This consists of a threaded rod, threaded sleeve and screw. The threaded rod/sleeve combination is selected as appropriate to the chosen number of individual sub-bases.

A valve terminal can be easily extended by adding individual sub-bases or supply modules. This is done by inserting suitable tie rod extenders between the threaded rod and sleeve. This ensures that the valve terminal can be rapidly and reliably extended.

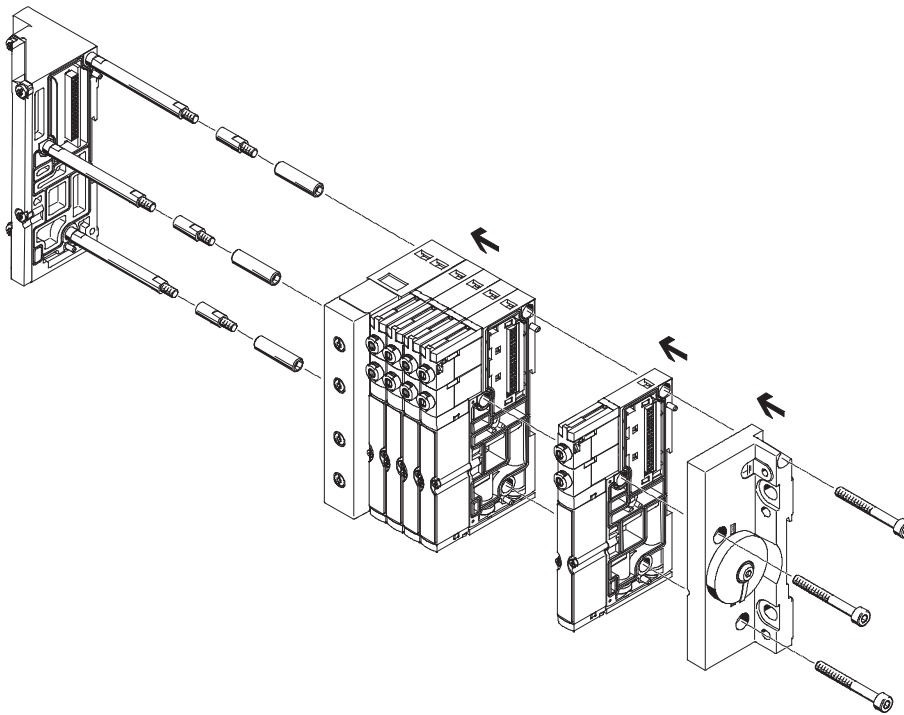

 Note
 The tie rod system for the valve terminals MPA-L consists of at least four sub-bases or two sub-bases and one supply module. Shorter valve terminals with two or more valve positions can be constructed without a sleeve.

Modular electrical peripherals

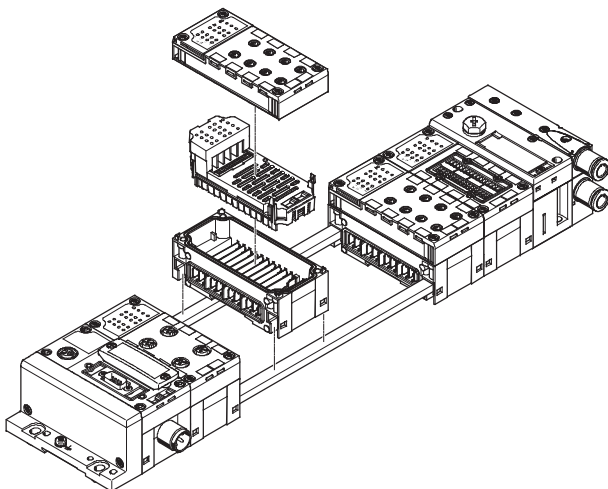

The mechanical connection between the CPX modules is established using tie rods. Two screws in the end plates are all that are needed to assemble the entire unit.

The tie rod ensures that the unit resists high mechanical loads and is therefore the mechanical backbone of the CPX terminal.

The open design allows interlinking blocks to be replaced in assembled state.

The tie rod extension kit allows an extra module to be added to the CPX terminal.

The input/output modules, connection blocks, fieldbus nodes or control block of the CPX system are mounted on the interlinking blocks using four screws and can be almost infinitely replaced or modified.

Valve terminals type 34 MPA-L

Peripherals overview

Valve terminal pneumatic components

The sub-bases are available individually with one valve position or with four valve positions.

The electrical interlinking modules are available for:

- 1 or 4 single solenoid valves
- 1 or 4 double solenoid valves

• Double solenoid valve positions can be fitted with any valve or a blanking plate.

• Single solenoid valve positions can only be fitted with single solenoid valves or a blanking plate.

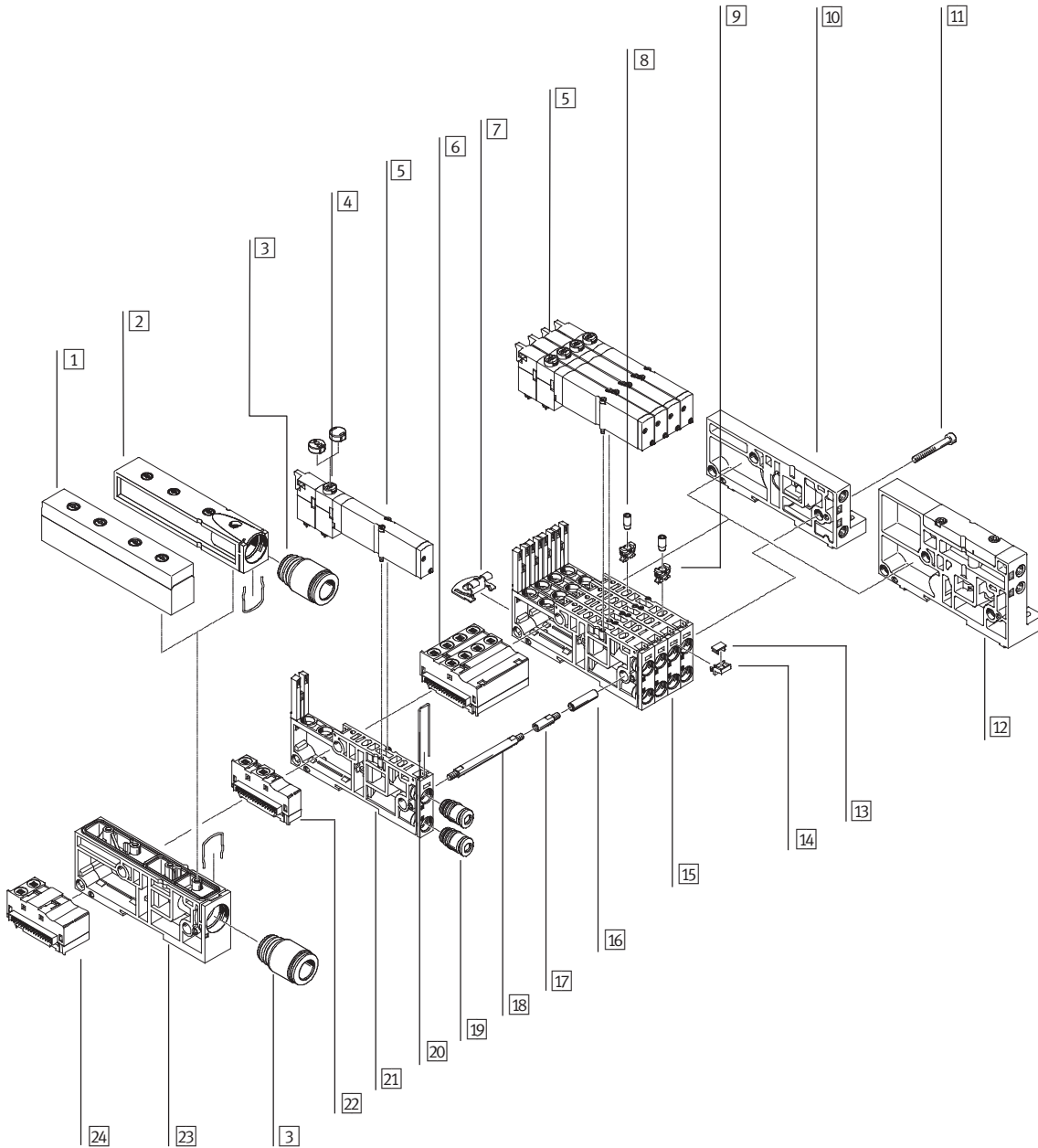

Valve terminals type 34 MPA-L

Peripherals overview

Valve terminal pneumatic components		
Designation	Brief description	→ Page/Internet
1 Plate	Exhaust plate as flat plate silencer	41
2 Plate	Exhaust plate for ducted exhaust air	41
3 Cartridge fitting	For supply and exhaust ports	44
4 Cover cap for manual override	Conversion from detenting/non-detenting to non-detenting or covered	42
5 Solenoid valve	Single solenoid	38
6 Electrical interlinking module, 4-way	Electrical interlinking module for combination of four sub-bases, single solenoid/double solenoid	40
7 Mounting bracket	Mounting bracket for wall mounting	40
8 Restrictor	Fixed restrictor for installation in duct 3 or 5 of the sub-base	40
9 Retainer for fixed restrictor	Required to install the fixed restrictor	40
10 Right-hand end plate, low	End plate with pilot air selector, with ports 12/14, 82/84	42
11 Screw	Tie rod system, connects the sub-bases	39
12 Right-hand end plate, high	End plate with pilot air selector, with ports 1, 3, 5, 12/14, 82/84	42
13 Inscription label	6 x 10 mm	46
14 Holder for inscription label	–	46
15 Sub-base	Four individual sub-bases screwed together to form one unit	38
16 Sleeve	Tie rod system, connects the sub-bases	39
17 Tie rod extender	For subsequent modular extension of the valve terminal	39
18 Tie rod	Threaded rod, clamps the sub-bases between the end plates	39
19 Cartridge fitting	For working lines	44
20 Clamp strap for cartridge fitting	–	–
21 Sub-base, individual	Sub-base with one valve position	38
22 Electrical interlinking module	Electrical interlinking module for single sub-base, single solenoid/double solenoid	40
23 Supply module	For compressed air supply/exhaust air	41
24 Electrical interlinking module	Electrical interlinking module for supply module, signals are passed through	40

Valve terminals type 34 MPA-L

Peripherals overview

Valve terminal with multi-pin plug connection

Order code:

- 34P...

MPA-L valve terminals with multi-pin plug connection can be expanded by up to 32 solenoid coils/valve positions.

The multi-pin plug connection is removable and designed as a 9, 25 or 44-pin Sub-D connection. The multi-pin plug connection can alternatively be ordered as a terminal strip (33-pin) or flat cable connection (40-pin).

The Sub-D multi-pin plug connection, 25 and 44-pin, is available to IP40 and IP67 or with multi-pin plug cover, without connecting cable, with a choice of cable outlet to the side or front.

Sub-D multi-pin plug connection, 25 and 44-pin, with multi-pin plug cover with pre-assembled cable:

- 2.5 m
- 5 m
- 10 m
- Variable, up to 30 m

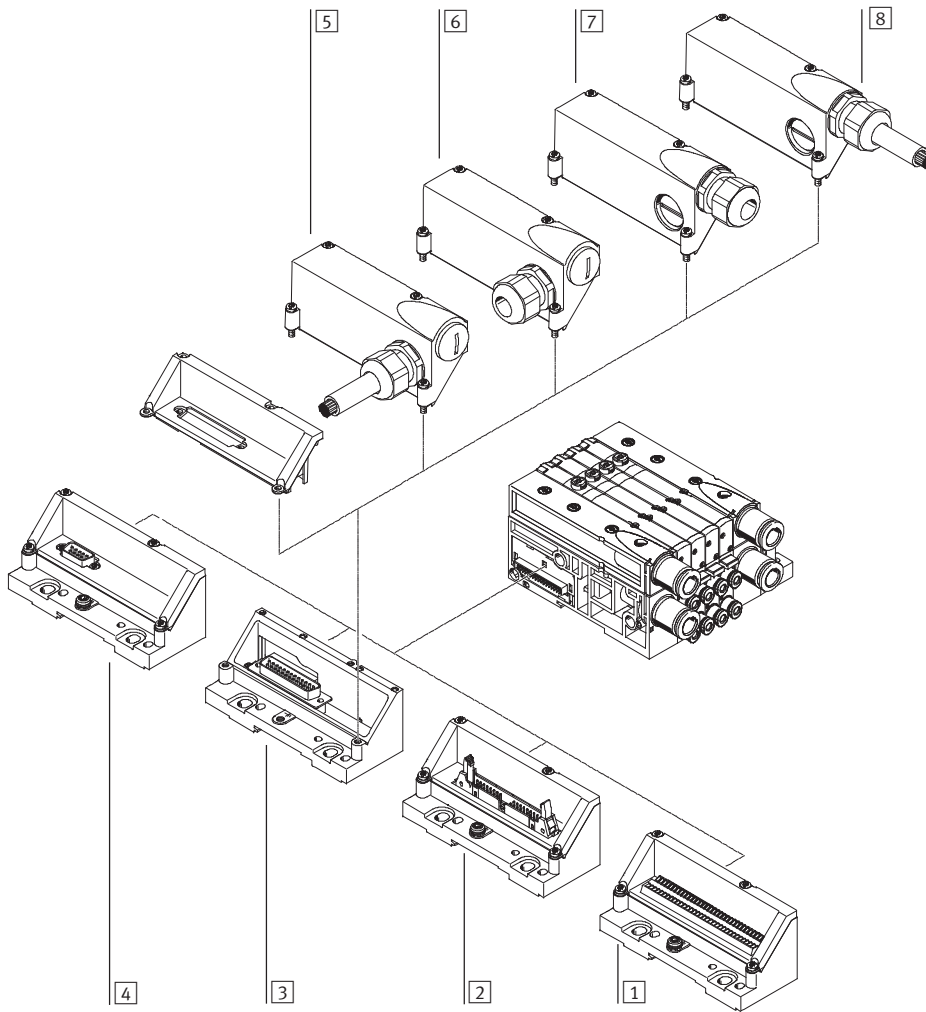

Designation	Brief description	→ Page/Internet
1 Multi-pin plug connection	Terminal strip, 33-pin, IP40	42
2 Multi-pin plug connection	For flat cable, 40-pin, IP40	42
3 Multi-pin plug connection	Sub-D, 25-pin	42
4 Multi-pin plug connection	Sub-D, 9-pin, IP40	42
5 Connecting cable	With cover, pre-assembled, connection on side, IP67	43
6 Cover	For self-assembly, connection on side, IP67	43
7 Cover	For self-assembly, connection on front, IP67	43
8 Connecting cable	With cover, pre-assembled, connection on front, IP67	43

Valve terminals type 34 MPA-L

Peripherals overview

Valve terminal with fieldbus connection, control block (electrical peripherals CPX)

Order code:

- 34P-... for the pneumatic components
- 50E-... for the electrical peripherals

Valve terminals with CPX interface can be expanded by up to 32 solenoid coils/valve positions.

Up to 32 valve positions can be equipped in combination with single solenoid valves; the maximum number of valve positions is reduced to 16 if only double solenoid valves are used.

The maximum number of addresses is set in the range 4 ... 32 solenoid coils via a selector switch.

This enables extensions to be pre-assigned in a control program and called up by means of manual settings.

Each valve position can be equipped with any valve or a blanking plate. The rules for CPX apply to the equipment that can be used in combination with the electrical peripherals CPX.

In general:

- Digital inputs/outputs
- Analogue inputs/outputs
- Parameterisation of inputs and outputs
- Integrated multi-featured diagnostic system
- Preventive maintenance concepts

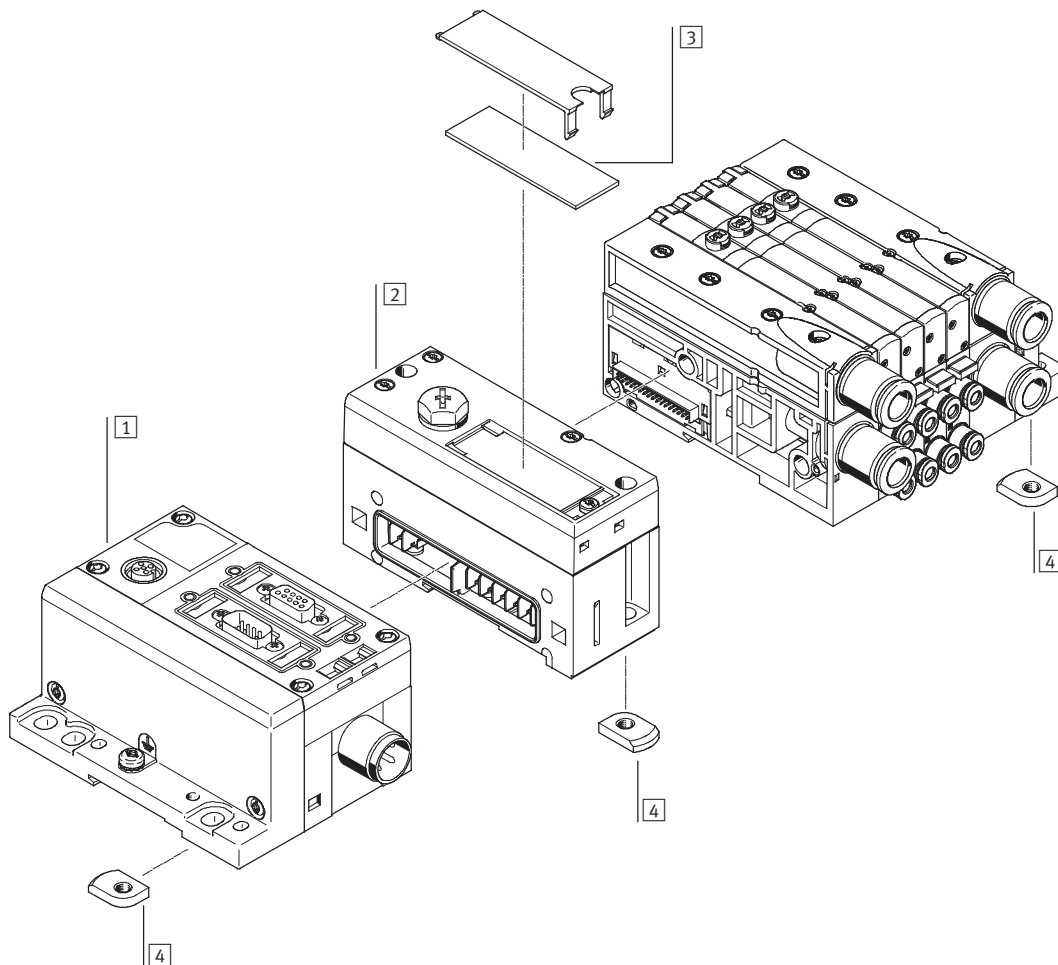

Designation	Brief description	→ Page/Internet
1 CPX modules	Fieldbus node, control block, input and output modules	cpx
2 Left-hand end plate	Pneumatic interface for CPX terminal	42
3 Inscription label	Large, for left-hand end plate/pneumatic interface for CPX terminal	-
4 H-rail mounting	-	40

Valve terminals type 34 MPA-L

Key features – Pneumatic components

Sub-base valve

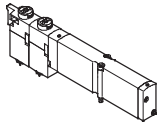

MPA-L offers a comprehensive range of valve functions. All valves are equipped with piston spool and patented sealing system that facilitates efficient sealing, a broad pressure range and long service life. They have a pneumatic pilot control for optimising performance.

Air is supplied by means of pilot air supply.
Sub-base valves can be quickly replaced since the tubing connectors remain on the sub-base.
This design is also particularly slim.

Irrespective of the valve function there are sub-base valves with one solenoid coil (single solenoid) or with two solenoid coils (double solenoid or two single solenoid valves in one housing).

Design

Valve replacement

The valves are attached to the sub-base using two screws, which means that they can be easily replaced. The

mechanical sturdiness of the sub-base guarantees good long-term sealing.

Extension

Blanking plates can be replaced by valves at a later date. The dimensions, mounting points and existing pneumatic installations remain unchanged in this case.

The valve code (M, J, N, NS, K, KS, H, HS, B, G, E, X, W, D, DS, I) is located on the front of the valve beneath the manual override.

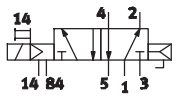
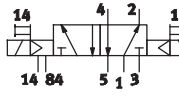
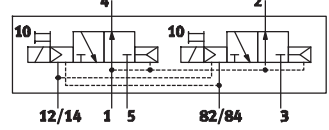
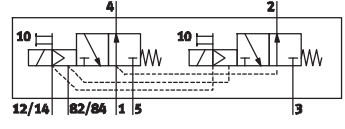
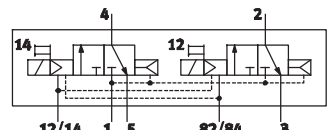
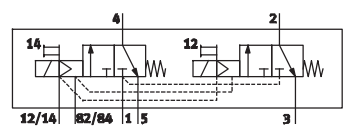
Valve function		
Circuit symbol	Code	Description
	Position function 1-32: M	5/2-way valve, single solenoid <ul style="list-style-type: none"> • Pneumatic spring return • Reversible • Suitable for vacuum
	Position function 1-32: J	5/2-way valve, double solenoid <ul style="list-style-type: none"> • Reversible • Suitable for vacuum
	Position function 1-32: N	2x 3/2-way valve, single solenoid <ul style="list-style-type: none"> • Normally open • Pneumatic spring return • Operating pressure > 3 bar
	Position function 1-32: NS	2x 3/2-way valve, single solenoid <ul style="list-style-type: none"> • Normally open • Mechanical spring return • Operating pressure -0.9 ... +8 bar
	Position function 1-32: K	2x 3/2-way valve, single solenoid <ul style="list-style-type: none"> • Normally closed • Pneumatic spring return • Operating pressure > 3 bar
	Position function 1-32: KS	2x 3/2-way valve, single solenoid <ul style="list-style-type: none"> • Normally closed • Mechanical spring return • Operating pressure -0.9 ... +8 bar

Valve terminals type 34 MPA-L

Key features – Pneumatic components

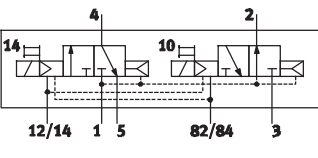
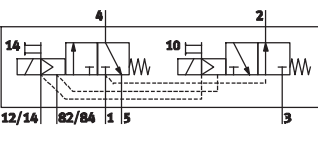
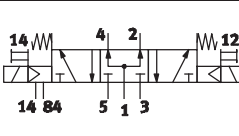
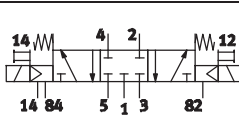
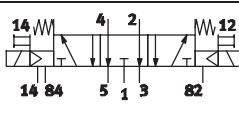
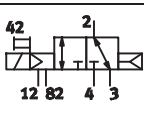
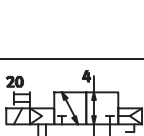
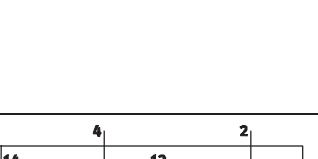
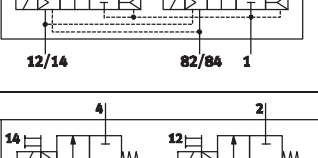
Valve function		
Circuit symbol	Code	Description
	Position function 1-32: H	2x 3/2-way valve, single solenoid <ul style="list-style-type: none"> • Normally <ul style="list-style-type: none"> – 1x closed – 1x open • Pneumatic spring return • Operating pressure > 3 bar
	Position function 1-32: HS	2x 3/2-way valve, single solenoid <ul style="list-style-type: none"> • Normally <ul style="list-style-type: none"> – 1x closed – 1x open • Mechanical spring return • Operating pressure –0.9 ... +8 bar
	Position function 1-32: B	5/3-way valve <ul style="list-style-type: none"> • Mid-position pressurised¹⁾ • Mechanical spring return • Reversible • Suitable for vacuum
	Position function 1-32: G	5/3-way valve <ul style="list-style-type: none"> • Mid-position closed¹⁾ • Mechanical spring return • Reversible • Suitable for vacuum
	Position function 1-32: E	5/3-way valve <ul style="list-style-type: none"> • Mid-position exhausted¹⁾ • Mechanical spring return • Reversible • Suitable for vacuum
	Position function 1-32: X	1x 3/2-way valve, single solenoid <ul style="list-style-type: none"> • Normally closed • External compressed air supply • Pneumatic spring return • Reversible Compressed air (–0.9 ... +10 bar) supplied at working line 4 can be switched with both internal and external pilot air supply.
	Position function 1-32: W	1x 3/2-way valve, single solenoid <ul style="list-style-type: none"> • Normally open • External compressed air supply • Pneumatic spring return • Reversible Compressed air (–0.9 ... +10 bar) supplied at working line 2 can be switched with both internal and external pilot air supply.
	Position function 1-32: D	2x 2/2-way valve <ul style="list-style-type: none"> • Normally closed • Pneumatic spring return • Operating pressure > 3 bar
	Position function 1-32: DS	2x 2/2-way valve <ul style="list-style-type: none"> • Normally closed • Mechanical spring return • Operating pressure –0.9 ... +8 bar

Valve terminals type 34 MPA-L

Key features – Pneumatic components

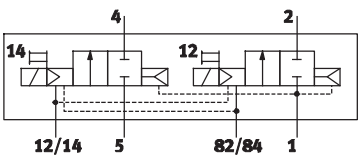
Valve function		
Circuit symbol	Code	Description
	Position function 1-32: I	<p>2x 2/2-way valve</p> <ul style="list-style-type: none"> • 1x normally closed • 1x normally closed, reversible • Pneumatic spring return • Operating pressure > 3 bar • Vacuum at port 3/5 only

- 1) If neither solenoid coil is energised, the valve moves to its mid-position by means of spring force.
 If both coils are energised at the same time, the valve remains in the previously assumed switching position.

 - Note

A filter must be installed upstream of valves operated in vacuum mode. This prevents any foreign matter in the intake air getting into the valve (e.g. when operating a suction cup).

Blanking plate

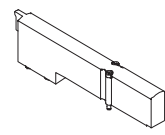

Blanking plate (code L) without valve function, for reserving valve positions on a valve terminal.

Valves and blanking plates are attached to the sub-base using two screws.

Fixed restrictor

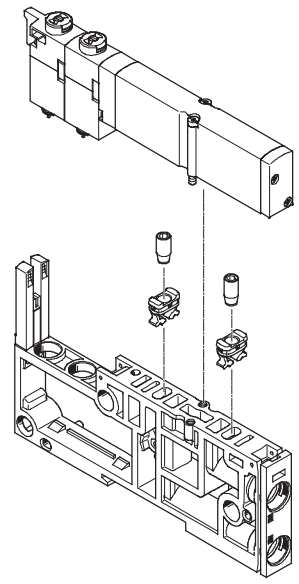

The fixed restrictor can be used to permanently set the flow rate when venting in ducts 3 and 5.

- Mounting:
- Press the retainer as far as it will go into the exhaust openings on the sub-base
 - Screw the fixed restrictor into the retainer
 - Mount the valve on the sub-base

The restrictor cuts a thread into the retainer as it is screwed in. For that reason, the retainer should be changed when a restrictor is repeatedly replaced.

The restrictor is available in seven different nominal sizes (0.3 ... 1.7 mm). The individual sizes are colour-coded to make them easy to distinguish.

Fixed restrictors enable, for example, the cylinder speed to be set to a predefined limit in response to known flow rate conditions. They cannot be accessed during operation and are therefore protected against manipulation. This is beneficial in the production of standard machines since the required speed can be determined once and the installation simply duplicated for further machines, saving time and costs for repeated commissioning.

Valve terminals type 34 MPA-L

Key features – Pneumatic components

Compressed air supply and venting

Supply module

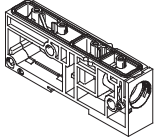

Right-hand end plate

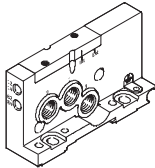

The valve terminal MPA-L can be supplied with compressed air at one or more points via supply modules and/or the right-hand end plate. The generously sized pneumatic system enables good performance from all functional components, even with large-scale expansions.

Venting (ducts 3 and 5) either takes place via silencers or ports for ducted exhaust air via the supply modules or the right-hand end plate.

There are two types of supply module with venting:

- Exhaust air 3/5 via flat plate silencer
- Exhaust air 3/5 ducted

Venting (ducts 3 and 5) can alternatively or additionally take place via the right-hand end plate.

The ducts 3 and 5 are separate in the terminal and are only joined together in the supply module. The exhaust air from the pilot air (duct 82/84) is entirely separate from ducts 3 and 5.

Pilot air supply

The valve terminal type 34 MPA-L is supplied with pilot air exclusively via the right-hand end plate. The pilot air

supply can be selected at the pilot air selector on the end plate:

- Internal (from duct 1) or
- External (from duct 12/14)

Switching position for internal, marked "Int"

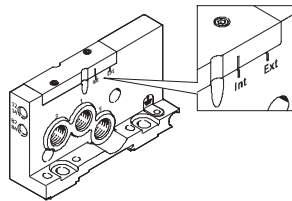
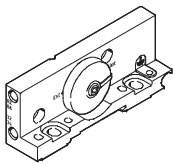

Internal pilot air supply can be selected if the supply pressure for the terminal is between 3 and 8 bar. In this case, the pilot air supply is branched by means of an internal

connection from duct 1 in the right-hand end plate. Port 12/14 on the right-hand end plate can be sealed using a blanking plug.

Switching position for external, marked "Ext"

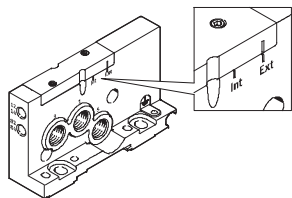
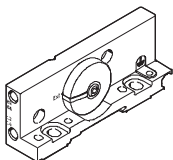

If the supply pressure (at the right-hand end plate) is less than 3 bar or greater than 8 bar, then the valve terminal MPA-L must be operated with an external pilot air supply. The pilot air supply is then fed via port 12/14

on the right-hand end plate. When using several pressure zones, the supply pressure in the pressure zone with the right-hand end plate is decisive.

 Note

If a gradual pressure build-up in the system using a soft-start valve is chosen, an external pilot air supply

should be connected so that the control pressure applied during switch-on is already very high.

Valve terminals type 34 MPA-L

Key features – Pneumatic components

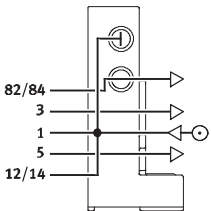
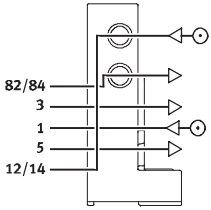
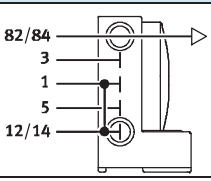
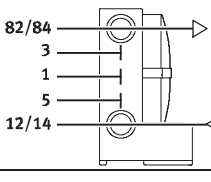
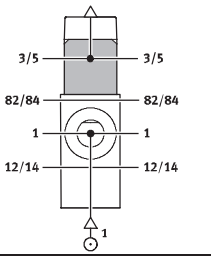
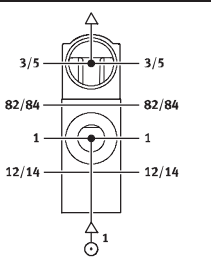
Compressed air supply and pilot air supply		
Pictorial representation	Code	Notes
Right-hand end plate, with supply ports		
	Right-hand end plate: D Pilot air: –	Internal pilot air supply <ul style="list-style-type: none"> • Pilot air is branched internally from port 1 in the right-hand end plate • Exhaust air 3/5 via right-hand end plate or supply module • Pilot exhaust air 82/84 via right-hand end plate • For operating pressure in the range 3 ... 8 bar
	Right-hand end plate: D Pilot air: E	External pilot air supply <ul style="list-style-type: none"> • Pilot air supply (3 ... 8 bar) is connected at the right-hand end plate at port 12/14 • Exhaust air 3/5 via right-hand end plate or supply module • Pilot exhaust air 82/84 via right-hand end plate • For operating pressure in the range –0.9 ... 10 bar (suitable for vacuum)
Right-hand end plate, without supply ports		
	Right-hand end plate: – Pilot air: –	Internal pilot air supply <ul style="list-style-type: none"> • Pilot air is branched internally from port 1 in the right-hand end plate • Exhaust air 3/5 via supply module • Pilot exhaust air 82/84 via right-hand end plate • For operating pressure in the range 3 ... 8 bar
	Right-hand end plate: – Pilot air: E	External pilot air supply <ul style="list-style-type: none"> • Pilot air supply (3 ... 8 bar) is connected at the right-hand end plate at port 12/14 • Exhaust air 3/5 via supply module • Pilot exhaust air 82/84 via right-hand end plate • For operating pressure in the range –0.9 ... 10 bar (suitable for vacuum)
Supply module, flat plate silencer		
	Type of module block 1-40: U Exhaust port: –	<ul style="list-style-type: none"> • Exhaust air 3/5 via flat plate silencer • Pilot exhaust air 82/84 via right-hand end plate • For operating pressure in the range –0.9 ... 10 bar (suitable for vacuum)
Supply module, ducted exhaust air		
	Type of module block 1-40: U Exhaust port: UD, UE, UF, UM, UN, UP or UG	<ul style="list-style-type: none"> • Exhaust air 3/5 via supply module • Pilot exhaust air 82/84 via right-hand end plate • For operating pressure in the range –0.9 ... 10 bar (suitable for vacuum)

Valve terminals type 34 MPA-L

Key features – Pneumatic components

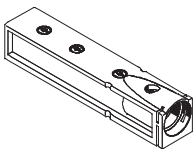
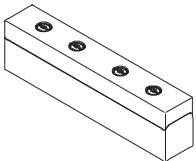
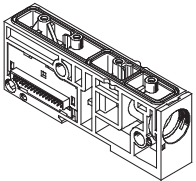
Supply module				
Pictorial representation	Code	Type	Designation	Notes
	Exhaust port: UD, UE, UF, UM, UN, UP or UG	VMPAL-EG	Exhaust plate for ducted exhaust air	Additional supply modules can be used for larger terminals or to create additional pressure zones. Supply modules can be configured at any point upstream or downstream of the sub-bases. Supply modules contain the following ports: <ul style="list-style-type: none"> Compressed air supply (duct 1) Exhaust air (duct 3/5) Depending on your order, the exhaust ducts are either ducted or vented via the flat plate silencer.
	Exhaust port: –	VMPAL-EU	Flat plate silencer	
	Type of module block 1-40: U	VMPAL-SP-0	Supply module with electrical interlinking module	

Pneumatic interface

The electrical power for the valves can also be supplied via the serial bus of the CPX terminal. The interlinking in the pneumatic section of the valve terminal remains the same as with a multi-pin plug connection. The pneumatic interface (left-hand end plate) serves as an adapter between the two current feeds.

In the pneumatic interface, the serial signals from the CPX terminal are converted into parallel signals. The number of addresses (solenoid coils that can be connected) is set via a selector (rotary switch) on the pneumatic interface.

Advantage:

Switching from a multi-pin plug connection to fieldbus connection via the CPX terminal and vice versa is possible by swapping the left-hand end

plate; the pneumatic interlinking is left as it is.

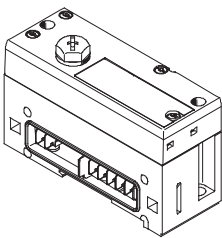
Pneumatic interface			
Pictorial representation	Code	Type	Notes
	Electrical connection: CX	VMPAL-...-EPL	After converting or extending the valve terminal, the number of output addresses occupied by the pneumatic components must be checked and if applicable adjusted via the rotary switch on the pneumatic interface. This is not necessary if a sufficiently large address space was previously reserved for the extension (the standard setting on delivery provides for 32 valves). The maximum number of addresses is specified via a selector switch in the range 4 ... 32 solenoid coils. This enables extensions to be pre-assigned in a control program and called up by means of manual settings.

Valve terminals type 34 MPA-L

Key features – Pneumatic components

Creating pressure zones and separating exhaust air

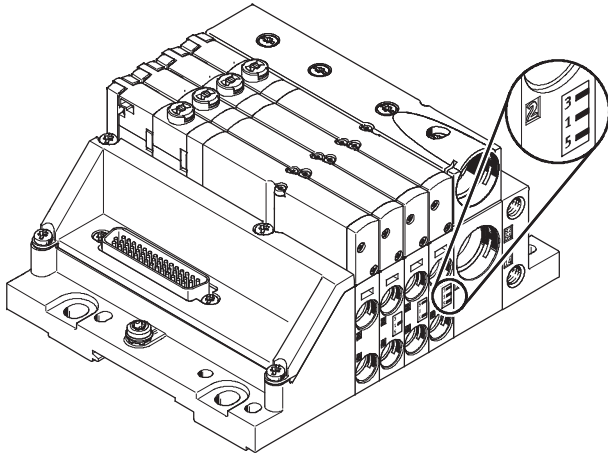

MPA-L offers a number of options for creating pressure zones if different working pressures are required. Up to nine pressure zones in total are possible.

Pressure zones are created by isolating the internal supply ducts in a special sub-base. Each pressure zone must have its own compressed air supply.

Compressed air can be supplied and vented via a supply module and/or the right-hand end plate.

The position of the supply modules and the sub-bases with pressure zone separation can be freely chosen with the valve terminal MPA-L.

The sub-bases with pressure zone separation are integrated in the terminal ex-works as per your order. They can be distinguished by their coding, even when the valve terminal is assembled. Duct separation is always takes place to the right of the sub-base.

Creating pressure zones		Code	Notes
Sub-bases with pressure zone separation			
Pictorial examples	Coding		
		Duct separation to the right of sub-base 1 - 40: –	<ul style="list-style-type: none"> No duct separation
		Duct separation to the right of sub-base 1 - 40: T	<ul style="list-style-type: none"> Duct 1 separated VMPAL-...-T1
		Duct separation to the right of sub-base 1 - 40: TR	<ul style="list-style-type: none"> Duct 3/5 separated VMPAL-...-T35
		Duct separation to the right of sub-base 1 - 40: TS	<ul style="list-style-type: none"> Ducts 1 and 3/5 separated VMPAL-...-T135

Valve terminals type 34 MPA-L

Key features – Pneumatic components

Examples: Compressed air supply and pilot air supply

Internal pilot air supply, right-hand end plate without supply ports

The illustration opposite shows an example of the configuration and connection of the air supply with internal pilot air supply.

The exhaust air (duct 3/5) is discharged via supply modules.

The pilot exhaust air (duct 82/84) is discharged via the right-hand end plate.

Special sub-bases are used to create pressure zones.

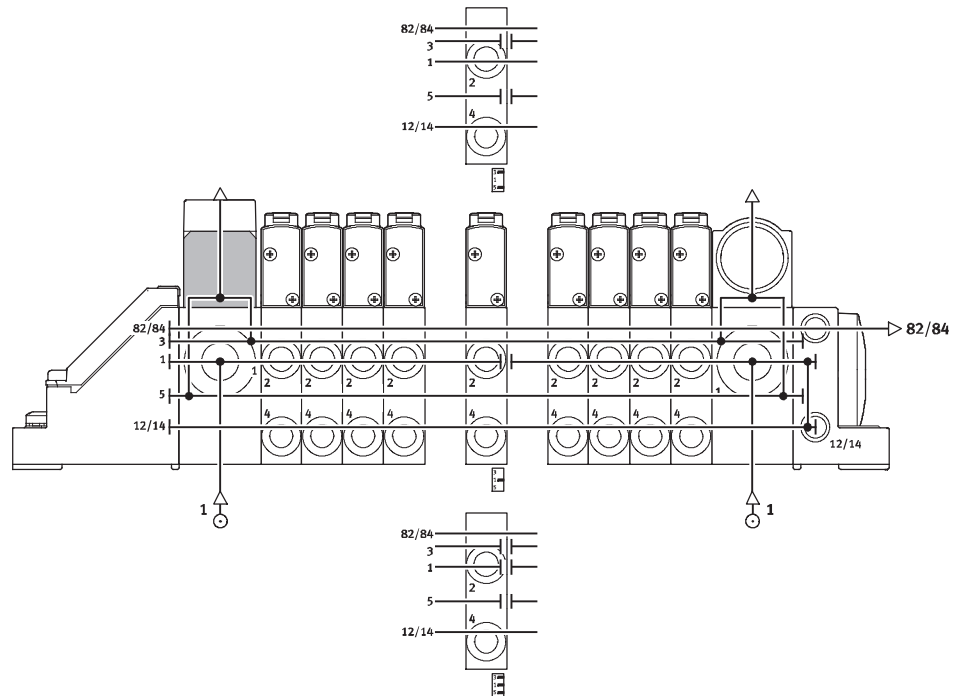

External pilot air supply, right-hand end plate without supply ports

The illustration opposite shows an example of the configuration and connection of the compressed air supply with external pilot air supply. Port 12/14 on the right-hand end plate is equipped with a fitting for this.

The exhaust air (duct 3/5) is discharged via supply modules.

The pilot exhaust air (duct 82/84) is discharged via the right-hand end plate.

Special sub-bases are used to create pressure zones.

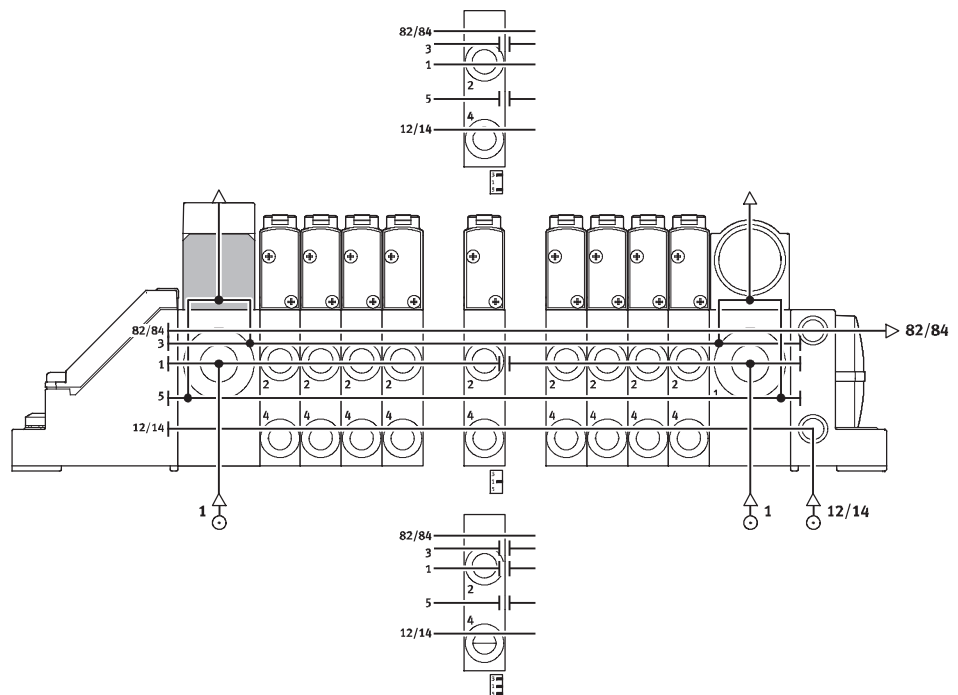

Valve terminals type 34 MPA-L

Key features – Pneumatic components

Sub-base

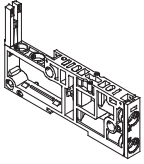

MPA-L is based on a modular system consisting of sub-bases and valves. The sub-bases are connected together using tie rods and thus form the support system for the valves. They contain the connection ducts for supplying compressed air to and venting from the valve terminal as well as the working lines for the pneumatic drives for each valve.

The sub-bases are joint together via tie rods. The tie rod consists of a threaded rod, threaded sleeve and screw. In principle, sub-bases have a modular structure. If this modularity is not required within a terminal, then four individual sub-bases can be combined with a 4-way electrical interlinking module to save costs.

The threaded rod/sleeve combination is selected as appropriate to the number and width of the individual plates or plate combination. To add further blocks, simply loosen the tie rod and adapt with extenders. There are no restrictions on extensions; a tie rod could be constructed almost entirely from extenders.

Sub-base variants

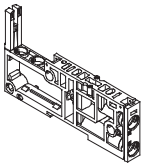
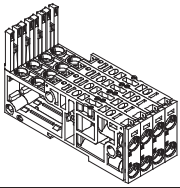
Pictorial representation	Code	Type	Notes
	-	VMPAL-AP-10	<ul style="list-style-type: none"> Working lines 2, 4 on the sub-base Without electrical interlinking module
		VMPAL-AP-10-QS	<ul style="list-style-type: none"> Working lines 2, 4 on the sub-base With electrical interlinking module
		VMPAL-AP-10-...-T1	<ul style="list-style-type: none"> Working lines 2, 4 on the sub-base With/without electrical interlinking module Duct separation in duct 1
		VMPAL-AP-10-T35	<ul style="list-style-type: none"> Working lines 2, 4 on the sub-base Without electrical interlinking module Duct separation in ducts 3 and 5
		VMPAL-AP-10-T135	<ul style="list-style-type: none"> Working lines 2, 4 on the sub-base Without electrical interlinking module Duct separation in ducts 1, 3 and 5
	Combination of 4 sub-bases: Z	VMPAL-AP-4x10	<ul style="list-style-type: none"> Working lines 2, 4 on the sub-base With/without electrical interlinking module No duct separation 4-valve unit, not suitable for pressure zone separation

Electrical interlinking module

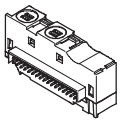
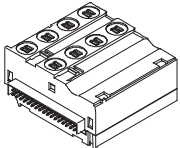
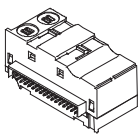
Pictorial representation	Code	Type	No. of solenoid coils (valve positions)	Notes
	Type of module block 1-40: A	VMPA1-EVAP-10-2	2 (1), double solenoid	Each solenoid coil must be assigned to a specific pin of the multi-pin plug in order for the valve to be actuated. Regardless of whether blanking plates or valves are used, valve positions occupy <ul style="list-style-type: none"> one coil/address (single solenoid valves) two coils/addresses (double solenoid valves)
	Type of module block 1-40: C	VMPA1-EVAP-10-1	1 (1), single solenoid	
	Type of module block 1-40: A	VMPA1-EVAP-10-2-4	8 (4), double solenoid	The electrical interlinking modules are colour-coded: <ul style="list-style-type: none"> Single solenoid – grey Double solenoid – black
	Type of module block 1-40: C	VMPA1-EVAP-10-1-4	4 (4), single solenoid	
	Type of module block 1-40: U	VMPA1-EVAP-20-SP	-	Electrical interlinking module for supply module

Valve terminals type 34 MPA-L

Key features – Pneumatic components

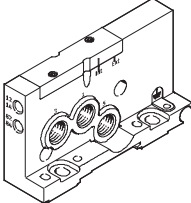
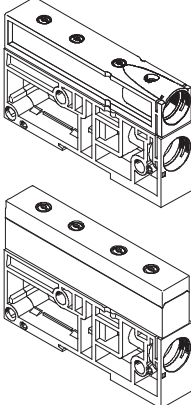
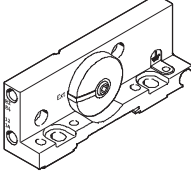
Ports for supply and venting					
	Code	Port		QS fitting/cartridge fitting	
Right-hand end plate with supply ports 1, 3, 5					
	Right-hand end plate: D	1	Air/vacuum supply	Thread G $\frac{1}{4}$	QS-G $\frac{1}{4}$, straight, for tubing O.D. 8 mm, 10 mm, 12 mm, $\frac{5}{16}$ ", $\frac{3}{8}$ ", $\frac{1}{2}$ "
		3	Exhaust air	Thread G $\frac{1}{4}$	
		5	Exhaust air	Thread G $\frac{1}{4}$	
		12/14	Pilot air supply	Thread M7	QSM-M7, straight or angled, for tubing O.D. 4 mm, 6 mm, $\frac{1}{4}$ "
		82/84	Pilot exhaust air	Thread M7	
Supply module					
	Type of module block 1-40: U	1	Air/vacuum supply	Cartridge fitting	QSPKG20, straight, for tubing O.D. 8 mm, 10 mm, 12 mm, $\frac{5}{16}$ ", $\frac{3}{8}$ ", $\frac{1}{2}$ ", adapter to thread G $\frac{1}{4}$
		3/5	Exhaust air	Flat plate silencer	–
				Cartridge fitting	QSPKG20, straight, for tubing O.D. 8 mm, 10 mm, 12 mm, $\frac{5}{16}$ ", $\frac{3}{8}$ ", $\frac{1}{2}$ ", adapter to thread G $\frac{1}{4}$
		12/14	Pilot air supply	–	–
		82/84	Pilot exhaust air	–	–
Right-hand end plate without supply ports					
	Right-hand end plate: –	1	Air/vacuum supply	–	–
		3	Exhaust air	–	–
		5	Exhaust air	–	–
		12/14	Pilot air supply	Thread M7	QSM-M7, straight or angled, for tubing O.D. 4 mm, 6 mm, $\frac{1}{4}$ "
		82/84	Pilot exhaust air	Thread M7	

Valve terminals type 34 MPA-L

Key features – Assembly

Valve terminal assembly

Sturdy terminal assembly thanks to:

- Four through-holes for wall mounting
- Additional mounting brackets
- H-rail mounting



Note
If the terminal is subject to strong vibrations or shock loads, use additional mounting brackets of the type VMPAL-BD for wall mounting.

These should be attached to the valve terminal every 13 cm (one mounting bracket every 10 valve positions).

Wall mounting – Multi-pin plug connection

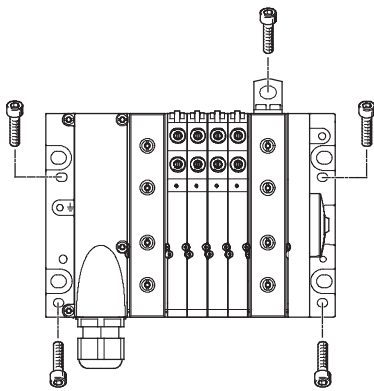

The MPA-L valve terminal is screwed onto the mounting surface using four M4 or M6 screws. The mounting holes are on the multi-pin plug connection

and on the right-hand end plate. Optional mounting brackets are also available.

Wall mounting – Fieldbus connection (CPX terminal)

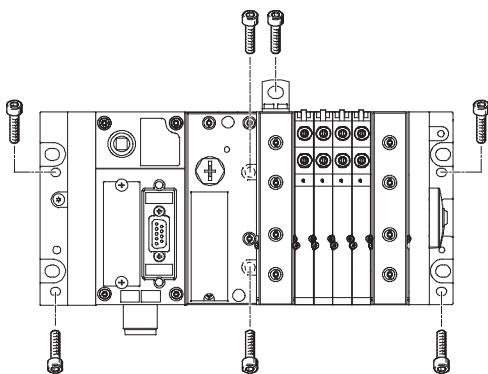

The MPA-L valve terminal is screwed onto the mounting surface using four M4 and two M6 screws or using six M6 screws. The mounting holes are

on the left-hand and right-hand end plate and on the pneumatic interface. Optional mounting brackets are also available.

H-rail mounting

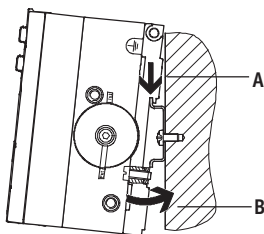

The MPA-L valve terminal is attached to the H-rail (see arrow A). The terminal is then swivelled onto the H-rail and secured in place with the clamping component (see arrow B).

The following MPA-L mounting kit is required for H-rail mounting of the valve terminal:

- With multi-pin plug connection: CPX-CPA-BG-NRH
- With fieldbus connection (CPX terminal): VMPAF-FB-BG-NRH

This enables mounting of the valve terminal on a H-rail to EN 60715.



Note
The mounting kits (see above) only lock the valve terminal in horizontal mounting position.

Valve terminals type 34 MPA-L

Key features – Assembly

Tie rod

Design

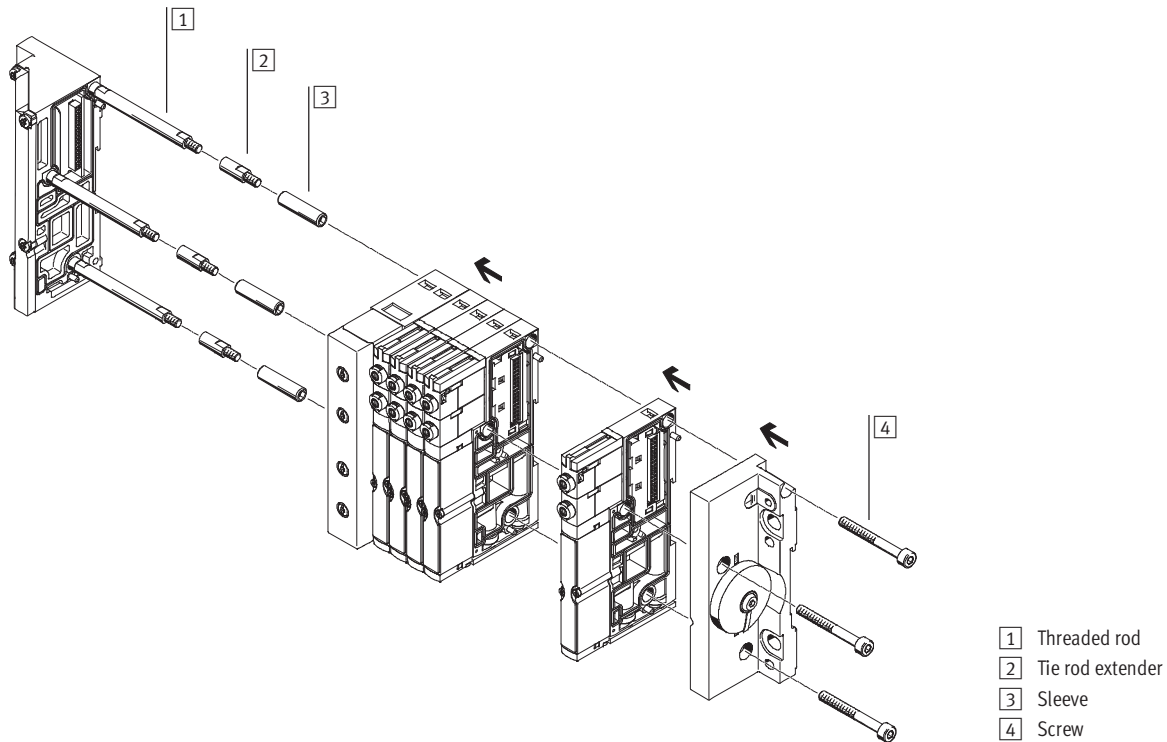

- 1 Threaded rod
- 2 Tie rod extender
- 3 Sleeve
- 4 Screw

Mode of operation

The tie rod for MPA-L consists of four parts:

- Threaded rod
- Tie rod extender
- Sleeve
- Screw

This enables valve terminals of any length to be constructed.

The tie rod and valve terminal are assembled in just four steps:

- Screw the threaded rods to the left-hand end plate
- Screw the sleeves to the threaded rods
- Push the sub-bases and supply modules onto the rod/sleeve combination
- Push on the right-hand end plate and secure with screws that engage into the sleeves

The tie rod enables subsequent extension of the valve terminal. This is done by loosening the tie rod screws and disassembling the relevant components. The additional sub-base or supply module is inserted at the required location. The previously disassembled components are then re-assembled.

To compensate for the change in length, the tie rod must be extended by the increase in length. This is done by screwing in extenders between the threaded rod and sleeve. There are suitable extenders for each sub-base, combination of four sub-bases and supply module.

Valve terminals type 34 MPA-L

Key features – Assembly

Tie rod – Components and design

Tie rod (threaded rod)

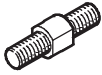

The threaded rod is used to construct a cost-optimised fixed-grid tie rod. The threaded rod is required with valve terminal lengths exceeding 42.45 mm, for example at least four sub-bases (10.7 mm each) or two sub-bases (10.7 mm each) and one supply module (21.2 mm), since only the combination of a threaded rod and sleeve offers the optimum compensation of tolerances (by compressing the seals between the sub-bases).

Tie rod extender

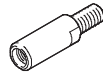

The valve terminal can be extended almost infinitely using tie rod extenders. The tie rod extenders are inserted between the threaded rod and sleeve and are available in appropriate lengths for sub-bases and supply modules.

Sleeve

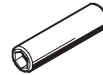

The primary purpose of the sleeve is to compensate tolerances that occur, for example, when the seals are compressed between the sub-bases during assembly. The sleeves come in different lengths, tailored to the use of a tie rod in a fixed grid as well as generally for the modular tie rods.

Screw



The entire valve terminal is clamped via the tie rod using the screw. Tolerances that occur, for example, when the seals are compressed between the sub-bases during assembly are compensated by the interaction of the screw and sleeve.

Individual modular tie rod

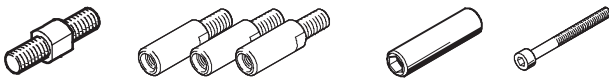

Tie rods can be constructed entirely using tie rod extenders. The threaded rod and sleeve are required to compensate tolerances that occur, for

example, when the seals are compressed between the sub-bases during assembly.

Fixed-grid tie rod with extension

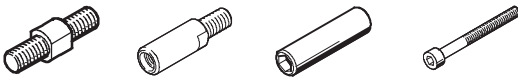

The tie rod extenders are inserted between the threaded rod and sleeve.

They are available in suitable lengths for sub-bases and supply modules.

Fixed-grid tie rod



The fixed-grid tie rod minimises assembly costs when assembling previously defined valve terminals. These valve terminals can be extended at any time.

The threaded rod (and if applicable also the sleeve) must be replaced if the valve terminal length is reduced.

Short valve terminal

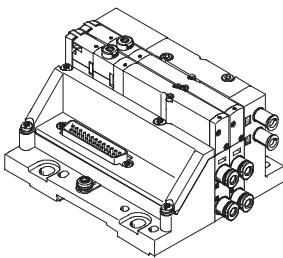

Valve terminals with a small number of valve positions are created by means of the following combinations:

- Valve terminals with two valve positions and without a supply module are connected solely using screws
- Valve terminals with three valve positions and without a supply module (or with one valve position and one supply module) are connected using a 10 mm tie rod extender and screw

Valve terminals type 34 MPA-L

Key features – Assembly

Ordering data – Fixed-grid tie rod				
Reference length	Part No.	Type	Part No.	Type
L = 10.65 x V + 21.15 x S	Tie rod		Sleeve	
42.45 ... 62.65	561116	VMPAL-ZAS-5	561135	VMPAL-ZAH-36
62.66 ... 72.30	561116	VMPAL-ZAS-5	561136	VMPAL-ZAH-46
72.31 ... 81.95	561116	VMPAL-ZAS-5	561137	VMPAL-ZAH-56
81.96 ... 91.60	561116	VMPAL-ZAS-5	561138	VMPAL-ZAH-66
91.61 ... 101.25	561117	VMPAL-ZAS-45	561135	VMPAL-ZAH-36
101.26 ... 110.90	561117	VMPAL-ZAS-45	561136	VMPAL-ZAH-46
110.91 ... 120.55	561117	VMPAL-ZAS-45	561137	VMPAL-ZAH-56
120.56 ... 130.20	561117	VMPAL-ZAS-45	561138	VMPAL-ZAH-66
130.21 ... 139.85	561118	VMPAL-ZAS-85	561135	VMPAL-ZAH-36
139.86 ... 149.50	561118	VMPAL-ZAS-85	561136	VMPAL-ZAH-46
149.51 ... 159.50	561118	VMPAL-ZAS-85	561137	VMPAL-ZAH-56
159.51 ... 169.15	561118	VMPAL-ZAS-85	561138	VMPAL-ZAH-66
169.16 ... 178.80	561119	VMPAL-ZAS-125	561135	VMPAL-ZAH-36
178.81 ... 188.45	561119	VMPAL-ZAS-125	561136	VMPAL-ZAH-46
188.46 ... 198.10	561119	VMPAL-ZAS-125	561137	VMPAL-ZAH-56
198.11 ... 207.75	561119	VMPAL-ZAS-125	561138	VMPAL-ZAH-66
207.76 ... 217.40	561120	VMPAL-ZAS-165	561135	VMPAL-ZAH-36
217.41 ... 227.05	561120	VMPAL-ZAS-165	561136	VMPAL-ZAH-46
227.06 ... 236.70	561120	VMPAL-ZAS-165	561137	VMPAL-ZAH-56
236.71 ... 246.35	561120	VMPAL-ZAS-165	561138	VMPAL-ZAH-66
246.36 ... 256.00	561121	VMPAL-ZAS-205	561135	VMPAL-ZAH-36
256.01 ... 266.00	561121	VMPAL-ZAS-205	561136	VMPAL-ZAH-46
266.01 ... 275.65	561121	VMPAL-ZAS-205	561137	VMPAL-ZAH-56
275.66 ... 285.30	561121	VMPAL-ZAS-205	561138	VMPAL-ZAH-66
285.31 ... 294.95	561122	VMPAL-ZAS-245	561135	VMPAL-ZAH-36
294.96 ... 304.60	561122	VMPAL-ZAS-245	561136	VMPAL-ZAH-46
304.61 ... 314.25	561122	VMPAL-ZAS-245	561137	VMPAL-ZAH-56
314.26 ... 323.90	561122	VMPAL-ZAS-245	561138	VMPAL-ZAH-66
323.91 ... 333.55	561123	VMPAL-ZAS-285	561135	VMPAL-ZAH-36
333.56 ... 343.20	561123	VMPAL-ZAS-285	561136	VMPAL-ZAH-46
343.21 ... 352.85	561123	VMPAL-ZAS-285	561137	VMPAL-ZAH-56
352.86 ... 362.50	561123	VMPAL-ZAS-285	561138	VMPAL-ZAH-66
362.51 ... 372.50	561124	VMPAL-ZAS-325	561135	VMPAL-ZAH-36
372.51 ... 382.50	561124	VMPAL-ZAS-325	561136	VMPAL-ZAH-46
382.51 ... 392.50	561124	VMPAL-ZAS-325	561137	VMPAL-ZAH-56
392.51 ... 402.50	561124	VMPAL-ZAS-325	561138	VMPAL-ZAH-66
402.51 ... 412.50	561125	VMPAL-ZAS-365	561135	VMPAL-ZAH-36
412.51 ... 422.50	561125	VMPAL-ZAS-365	561136	VMPAL-ZAH-46
422.51 ... 432.50	561125	VMPAL-ZAS-365	561137	VMPAL-ZAH-56
432.51 ... 442.50	561125	VMPAL-ZAS-365	561138	VMPAL-ZAH-66
442.51 ... 452.50	561126	VMPAL-ZAS-405	561135	VMPAL-ZAH-36
452.51 ... 462.50	561126	VMPAL-ZAS-405	561136	VMPAL-ZAH-46
462.51 ... 472.50	561126	VMPAL-ZAS-405	561137	VMPAL-ZAH-56
472.51 ... 482.50	561126	VMPAL-ZAS-405	561138	VMPAL-ZAH-66
482.51 ... 492.50	561127	VMPAL-ZAS-445	561135	VMPAL-ZAH-36
492.51 ... 502.50	561127	VMPAL-ZAS-445	561136	VMPAL-ZAH-46
502.51 ... 512.50	561127	VMPAL-ZAS-445	561137	VMPAL-ZAH-56
512.51 ... 522.50	561127	VMPAL-ZAS-445	561138	VMPAL-ZAH-66

V Number of valve positions
S Number of supply modules

Valve terminals type 34 MPA-L

Key features – Display and operation

Display and operation

Signal status display

Each solenoid coil is allocated an LED that indicates its signal status.

- Indicator 12 shows the switching status of the coil for duct 2
- Indicator 14 shows the switching status of the coil for duct 4

Manual override

The manual override (MO) enables the valve to be actuated when not electrically activated or energised. The valve is activated by pushing the manual override.

Alternatives:

- A cover (code: N or as accessory) enables the manual override to be actuated by pressing it using an appropriate tool.
- A cover (code V) can be fitted over the manual override to prevent it from being accidentally actuated.

Pneumatic connection and control elements

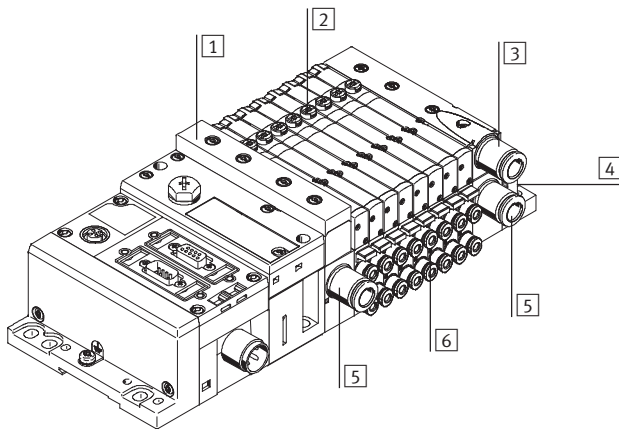

- 1 Flat plate silencer, duct 3/5
- 2 Manual override (for each pilot solenoid coil, non-detenting or non-detenting/detenting)
- 3 Ducted exhaust air, duct 3/5
- 4 Ports 12/14 for external pilot air supply and 82/84 for pilot exhaust air in the right-hand end plate (depending on version also ducts 1, 3 and 5)
- 5 Supply port, duct 1
- 6 Working lines, ducts 2 and 4, for each valve position

 **Note**

A valve actuated manually (by means of the manual override) cannot be reset electrically. Conversely, an electrically actuated valve cannot be reset using the manual override.

Manual override (MO)

MO with automatic return (non-detenting)

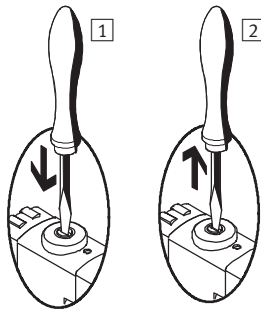

- 1 Press in the stem of the MO with a pointed object or screwdriver. Pilot valve switches and actuates the main valve.
- 2 Remove the pointed object or screwdriver. Spring force pushes the stem of the MO back. Pilot valve returns to its initial position and so too the single solenoid main valve (not with double solenoid valve code J).

MO set via turning (detenting)

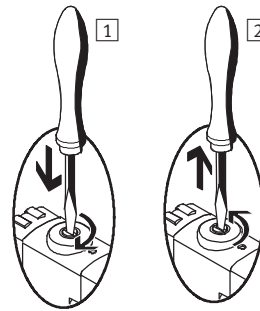

- 1 Press in the stem of the MO with a pointed object or screwdriver until the valve switches and then turn the stem clockwise by 90° until the stop is reached. Valve remains switched.
- 2 Turn the stem anti-clockwise by 90° until the stop is reached and then remove the pointed object or screwdriver. Spring force pushes the stem of the MO back. Valve returns to its initial position (not with double solenoid valve code J).

Valve terminals type 34 MPA-L

Key features – Electrical components

Inscription system

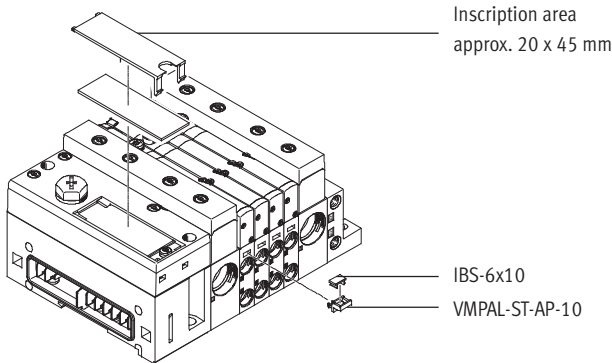

A holder VMPAL-ST-AP-10 (Part No. 561109) with inscription labels (Part No. 18576, IBS-6x10) can be mounted on each sub-base for labelling the valves.

Large inscription labels can be attached to the pneumatic interface as an alternative or in addition to the smaller labels.

Electrical power as a result of current reduction

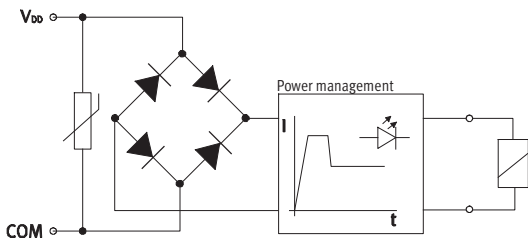

Each solenoid coil is protected with a spark arresting protective circuit as well as against polarity reversal. All valve types are additionally equipped with integrated current reduction.

MPA-L valves are supplied with operating voltage in the range 21.6 ... 26.4 V (24 V +/-10%).

Electrical multi-pin plug connection

The following multi-pin plug connections are offered for the valve terminal MPA-L:

- Sub-D (9-pin), 8 addresses
- Sub-D (25-pin), 24 addresses
- Sub-D (44-pin), 32 addresses
- Flat cable connection (40-pin), 32 addresses
- Terminal strip connection (33-pin), 32 addresses

Pins 1 ... 32 are used for addresses 0 ... 31 in order.

If fewer addresses are used for the valve terminal, the remaining pins (up to 32) are left free. The valves are switched by means of positive or negative logic (PNP or NPN). Mixed operation is not permitted.

Each pin on the multi-pin plug can actuate exactly one solenoid coil. If the maximum configurable number of valve positions is 32, this means that 32 valves, each with a single solenoid coil, can be addressed.

 Note
If a single solenoid valve is assembled on a double solenoid valve position, the second address is also occupied and cannot be used.

Guidelines on addressing for valves/solenoid coils

- The maximum possible number of addresses is 32.
- The numbering of the addresses goes from left to right in ascending consecutive order. The following applies to the individual valve positions: address x for coil 14 and address x+1 for coil 12.
- If single solenoid valves are mounted on sub-bases for double solenoid valves, the address of coil 12 and the assigned pin will remain unused.
- Each sub-base/electrical interlinking module occupies a defined number of addresses/pins:
 - For single solenoid valve: 1
 - For double solenoid valve: 2
- For combination of four sub-bases for single solenoid valves: 4
- For combination of four sub-bases for double solenoid valves: 8

Fieldbus connection CPX

All functions and features of the electrical peripherals CPX are permitted in connection with the CPX interface. This means:

- The valves and outputs are supplied via the system supply for the CPX terminal
- The valves can optionally be actuated or switched off separately from the outputs

 Note
Further information can be found at:
➔ Internet: cpx

Valve terminals type 34 MPA-L

Key features – Electrical components

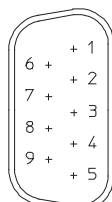
Pin allocation – Sub-D plug, 9-pin			
	Pin	Address/coil	
	1	0	6
	2	1	7
	3	2	8
	4	3	9
	5	4	0 V ¹⁾
			6
			7
			8
			9
			0 V ¹⁾

 Note

The drawing shows the view onto the pins of the Sub-D plug.

1) 0 V for positive switching control signals; connect 24 V for negative switching control signals; mixed operation is not permitted.

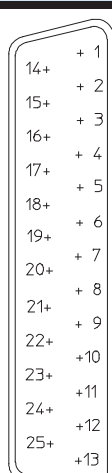
Pin allocation – Sub-D plug, 25-pin, connecting cable VMPAL-KM							
	Pin	Address/coil	Connecting cable wire colour ²⁾		Pin	Address/coil	Connecting cable wire colour ²⁾
	1	0	WH		14	13	BN YE
	2	1	GN		15	14	GY WH
	3	2	YE		16	15	BN GY
	4	3	GY		17	16	WH PK
	5	4	PK		18	17	BN PK
	6	5	BU		19	18	BU WH
	7	6	RD		20	19	BN BU
	8	7	VT		21	20	RD WH
	9	8	GY PK		22	21	BN RD
	10	9	RD BU		23	22	BK WH
	11	10	GN WH		24	23	BN
	12	11	BN GN		25	0 V ¹⁾	BK
	13	12	YE WH				

 Note

The drawing shows the view onto the pins of the Sub-D plug.

1) 0 V for positive switching control signals; connect 24 V for negative switching control signals; mixed operation is not permitted.
 2) To IEC 757

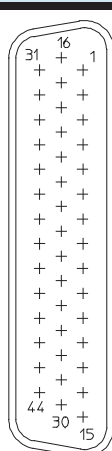
Pin allocation – Sub-D plug, 44-pin, connecting cable VMPAL-KM											
	Pin	Address/coil	Connecting cable wire colour ²⁾		Pin	Address/coil	Connecting cable wire colour ²⁾		Pin	Address/coil	Connecting cable wire colour ²⁾
	1	0	WH		18	17	BN PK		35	n.c.	n.c.
	2	1	GN		19	18	BU WH		36	n.c.	n.c.
	3	2	YE		20	19	BN BU		37	n.c.	n.c.
	4	3	GY		21	20	RD WH		38	n.c.	n.c.
	5	4	PK		22	21	BN RD		39	n.c.	n.c.
	6	5	BU		23	22	BK WH		40	n.c.	n.c.
	7	6	RD		24	23	BN		41	0 V ¹⁾	RD YE
	8	7	VT		25	24	BK BN		42	0 V ¹⁾	BK GN
	9	8	GY PK		26	25	GN GY		43	0 V ¹⁾	BK YE
	10	9	RD BU		27	26	YE GY		44	0 V ¹⁾	BK
	11	10	GN WH		28	27	GN PK				
	12	11	BN GN		29	28	YE PK				
	13	12	YE WH		30	29	GN BU				
	14	13	BN YE		31	30	YE BU				
	15	14	GY WH		32	31	RN GN				
	16	15	BN GY		33	n.c.	n.c.				
	17	16	WH PK		34	n.c.	n.c.				

 Note

The drawing shows the view onto the pins of the Sub-D plug.

1) 0 V for positive switching control signals; connect 24 V for negative switching control signals; mixed operation is not permitted.
 2) To IEC 757

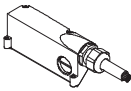
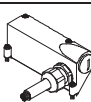
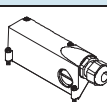

Valve terminals type 34 MPA-L

Key features – Electrical components

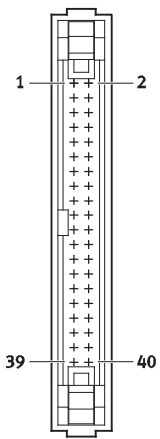

Ordering data						
Designation	Code	Description	Connection	Cable length	Part No.	Type
Connecting cable for multi-pin plug connection with Sub-D plug socket						
	Connecting cable: CA	Cable outlet to front (only with electrical connection code: MS6)	25-pin	2.5 m	560416	VMPAL-KM-V-SD25-IP67-2,5
	Connecting cable: CB			5 m	560417	VMPAL-KM-V-SD25-IP67-5
	Connecting cable: CC			10 m	560418	VMPAL-KM-V-SD25-IP67-10
	Connecting cable: –			Any	562389	VMPAL-KM-V-SD25-IP67-X
	Connecting cable: CQ	Cable outlet to front (only with electrical connection code: MS6)	25-pin	2.5 m	560410	VMPAL-KMSK-V-SD25-IP67-2,5
	Connecting cable: CR			5 m	560411	VMPAL-KMSK-V-SD25-IP67-5
	Connecting cable: CS			10 m	560412	VMPAL-KMSK-V-SD25-IP67-10
	Connecting cable: –			Any	562391	VMPAL-KMSK-V-SD25-IP67-X
	Connecting cable: CJ	Cable outlet to front (only with electrical connection code: MS8)	44-pin	2.5 m	560422	VMPAL-KM-V-SD44-IP67-2,5
	Connecting cable: CK			5 m	560423	VMPAL-KM-V-SD44-IP67-5
	Connecting cable: CL			10 m	560424	VMPAL-KM-V-SD44-IP67-10
	Connecting cable: –			Any	562390	VMPAL-KM-V-SD44-IP67-X
	Connecting cable: CD	Cable outlet to side (only with electrical connection code: MS6)	25-pin	2.5 m	560419	VMPAL-KM-S-SD25-IP67-2,5
	Connecting cable: CE			5 m	560420	VMPAL-KM-S-SD25-IP67-5
	Connecting cable: CH			10 m	560421	VMPAL-KM-S-SD25-IP67-10
	Connecting cable: –			Any	562392	VMPAL-KM-S-SD25-IP67-X
	Connecting cable: CT	Cable outlet to side (only with electrical connection code: MS6)	25-pin	2.5 m	560413	VMPAL-KMSK-S-SD25-IP67-2,5
	Connecting cable: CU			5 m	560414	VMPAL-KMSK-S-SD25-IP67-5
	Connecting cable: CV			10 m	560415	VMPAL-KMSK-S-SD25-IP67-10
	Connecting cable: –			Any	562394	VMPAL-KMSK-S-SD25-IP67-X
	Connecting cable: CM	Cable outlet to side (only with electrical connection code: MS8)	44-pin	2.5 m	560425	VMPAL-KM-S-SD44-IP67-2,5
	Connecting cable: CN			5 m	560426	VMPAL-KM-S-SD44-IP67-5
	Connecting cable: CP			10 m	560427	VMPAL-KM-S-SD44-IP67-10
	Connecting cable: –			Any	562393	VMPAL-KM-S-SD44-IP67-X
Cover for multi-pin plug connection without connecting cable with Sub-D plug socket						
	Connecting cable: EZ	Cable outlet to side or front (only with electrical connection code: MS6)	25-pin	–	560428	VMPAL-KM-SD25-IP67-0
	Connecting cable: EY	Cable outlet to side or front (only with electrical connection code: MS8)	44-pin	–	560429	VMPAL-KM-SD44-IP67-0

Valve terminals type 34 MPA-L

Key features – Electrical components

Pin allocation – Flat cable, 40-pin								
	Pin	Address/coil		Pin	Address/coil		Pin	Address/coil
	1	0		18	17		35	0 V ¹⁾
	2	1		19	18		36	0 V ¹⁾
	3	2		20	19		37	0 V ¹⁾
	4	3		21	20		38	0 V ¹⁾
	5	4		22	21		39	0 V ¹⁾
	6	5		23	22		40	0 V ¹⁾
	7	6		24	23		 Note The drawing shows the view onto the pins of the flat cable plug. The flat cable connection is established using plug connectors, in accordance with DIN EN 60603-13:1998-09 (NECU-FCG40-K). → Internet: necu	
	8	7		25	24			
	9	8		26	25			
	10	9		27	26			
	11	10		28	27			
	12	11		29	28			
	13	12		30	29			
	14	13		31	30			
	15	14		32	31			
	16	15		33	0 V ¹⁾			
	17	16		34	0 V ¹⁾			

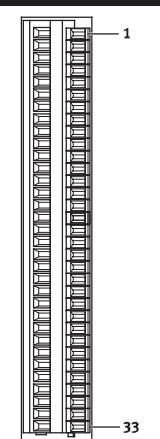
1) 0 V for positive switching control signals; connect 24 V for negative switching control signals; mixed operation is not permitted.

Pin allocation – Terminal strip, 33-pin								
	Pin	Address/coil		Pin	Address/coil		Pin	Address/coil
	1	0		16	15		31	30
	2	1		17	16		32	31
	3	2		18	17		33	0 V ¹⁾
	4	3		19	18		 Note The drawing shows the view onto the pins of the terminal strip. Cables with the following specifications can be connected: <ul style="list-style-type: none"> • Cable cross section 0.08 ... 0.5 mm² • Insulation 5 ... 6 mm 	
	5	4		20	19			
	6	5		21	20			
	7	6		22	21			
	8	7		23	22			
	9	8		24	23			
	10	9		25	24			
	11	10		26	25			
	12	11		27	26			
	13	12		28	27			
	14	13		29	28			
	15	14		30	29			

1) 0 V for positive switching control signals; connect 24 V for negative switching control signals; mixed operation is not permitted.

Valve terminals type 34 MPA-L

Key features – Electrical components

Instructions for use		
Equipment	Bio-oils	Mineral oils
<p>Operate system equipment with unlubricated compressed air if possible. Festo valves and cylinders are designed so that, if used as intended, they will not require additional lubrication and will still achieve a long service life.</p> <p>The quality of compressed air downstream of the compressor must correspond to that of unlubricated compressed air. If possible, do not operate all of your system equipment with lubricated compressed air. The lubricators should, where possible, always be installed directly upstream of the actuator used.</p>	<p>Unsuitable additional oil and too high an oil content in the compressed air reduce the service life of the valve terminal.</p> <p>Use Festo special oil OFSW-32 or the alternatives listed in the Festo catalogue (as specified in DIN 51524 HLP32; basic oil viscosity 32 CST at 40 °C).</p>	<p>When using mineral oils (e.g. HLP oils to DIN 51524, parts 1 to 3) or similar oils based on poly-alpha-olefins (PAO), the maximum residual oil content of 5 mg/m³ must not be exceeded (see ISO 8573-1 Class 4).</p> <p>A higher residual oil content irrespective of the compressor oil cannot be permitted, as the basic lubricant would be flushed out over time.</p>

Valve terminals type 34 MPA-L

Technical data

 - Flow rate
Up to 360 l/min

 - Width
10 mm

 - Voltage
24 V DC

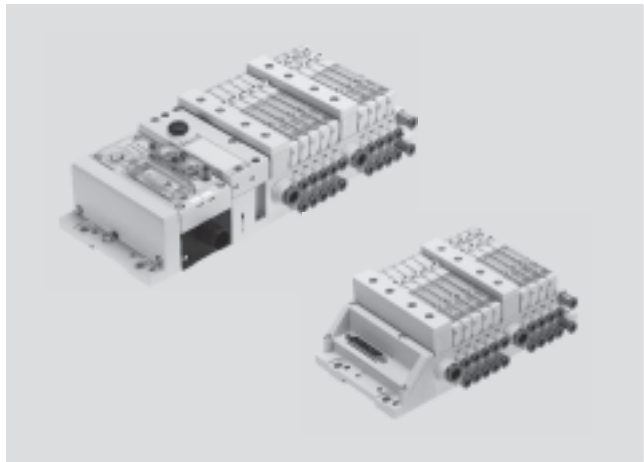

General technical data		
Design	Electromagnetically actuated piston spool valve	
Lubrication	Lubricated for life, PWIS-free (free of paint-wetting impairment substances)	
Type of mounting	Wall mounting On H-rail to EN 60715	
Mounting position	Any (wall mounting) Horizontal only (H-rail)	
Manual override	Non-detenting, detenting, blocked	
Width	[mm]	10
Pneumatic connections, right-hand end plate		
Supply	1	Thread G $\frac{1}{4}$ (QS-G $\frac{1}{4}$, straight, for tubing O.D. 8 mm, 10 mm, 12 mm, $\frac{5}{16}$ " , $\frac{3}{8}$ " , $\frac{1}{2}$ ")
Exhaust port	3	Thread G $\frac{1}{4}$ (QS-G $\frac{1}{4}$, straight, for tubing O.D. 8 mm, 10 mm, 12 mm, $\frac{5}{16}$ " , $\frac{3}{8}$ " , $\frac{1}{2}$ ")
	5	Thread G $\frac{1}{4}$ (QS-G $\frac{1}{4}$, straight, for tubing O.D. 8 mm, 10 mm, 12 mm, $\frac{5}{16}$ " , $\frac{3}{8}$ " , $\frac{1}{2}$ ")
Pilot air supply	12/14	Thread M7 (QSM-M7, straight or angled, for tubing O.D. 4 mm, 6 mm, $\frac{1}{4}$ ")
Pilot exhaust air	82/84	Thread M7 (QSM-M7, straight or angled, for tubing O.D. 4 mm, 6 mm, $\frac{1}{4}$ ")
Pneumatic connections, supply module		
Supply	1	Cartridge fitting 20 mm (QSPKG20, straight, for tubing O.D. 8 mm, 10 mm, 12 mm, $\frac{5}{16}$ " , $\frac{3}{8}$ " , $\frac{1}{2}$ " , adapter for thread G $\frac{1}{4}$), flat plate silencer
Exhaust port	3/5	Cartridge fitting 20 mm (QSPKG20, straight, for tubing O.D. 8 mm, 10 mm, 12 mm, $\frac{5}{16}$ " , $\frac{3}{8}$ " , $\frac{1}{2}$ " , adapter for thread G $\frac{1}{4}$), flat plate silencer
Pneumatic connections, sub-base		
Working lines	2	Cartridge fitting 10 mm (QSPKG10, straight or angled, for tubing O.D. 4 mm, 6 mm, $\frac{1}{8}$ " , $\frac{5}{32}$ " , $\frac{3}{16}$ " , $\frac{1}{4}$ " , adapter for thread M7)
	4	Cartridge fitting 10 mm (QSPKG10, straight or angled, for tubing O.D. 4 mm, 6 mm, $\frac{1}{8}$ " , $\frac{5}{32}$ " , $\frac{3}{16}$ " , $\frac{1}{4}$ " , adapter for thread M7)

Valve terminals type 34 MPA-L

Technical data

Operating and environmental conditions																	
Code for position function 1-32	M	J	B	G	E	X	W	N	K	H	D	I	NS	KS	HS	DS	
Operating medium	Filtered compressed air, lubricated or unlubricated, inert gases → 29																
Operating pressure [bar]	-0.9 ... +10							3 ... 10				-0.9 ... +8					
Operating pressure for valve terminal with internal pilot air supply	3 ... 8																
Pilot pressure [bar]	3 ... 8																
Ambient temperature [°C]	-5 ... +50																
Temperature of medium [°C]	-5 ... +50																
Storage temperature ¹⁾ [°C]	-20 ... +40																

1) Long-term storage

Pilot pressure p₂ as a function of working pressure p₁ with external pilot air supply

For valves with code M, J, B, G, E, X, W

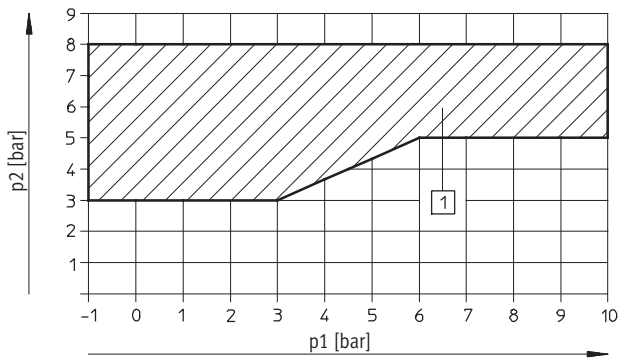

1) Operating range for valves with external pilot air supply

For valves with code N, K, H, D, I

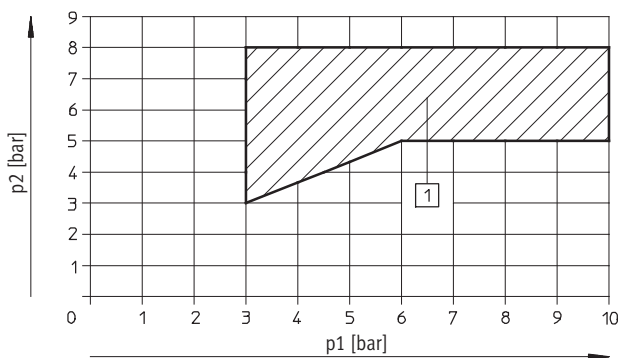

1) Operating range for valves with external pilot air supply

Valve terminals type 34 MPA-L

Technical data

Pilot pressure p2 as a function of working pressure p1 for valves with mechanical spring return

For valves with code NS, KS, HS, DS

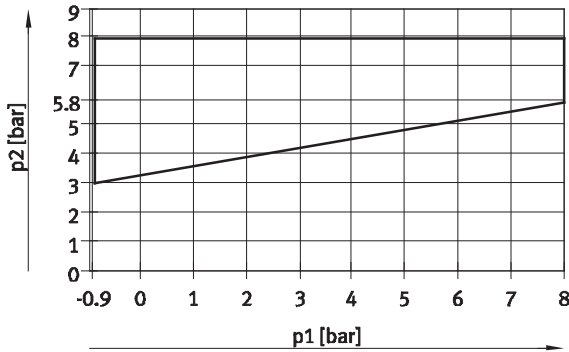

Nominal flow rate [l/min]			
Valve function	Code Position function 1-32	With fitting QS-6	
		From port 1 to 2, or 1 to 4	From port 2 to 3, or 4 to 5
5/2-way valve, single solenoid	M	360	360
1x 3/2-way valve	X	255	295
5/2-way valve, double solenoid	J	360	360
5/3-way valve, mid-position pressurised	B	300 (220) ¹⁾	270
5/3-way valve, mid-position closed	G	320	350
2x 2/2-way valve	I	260	260
5/3-way valve, mid-position exhausted	E	240	240 (200) ¹⁾
2x 3/2-way valve, normally closed	K	230	310
2x 3/2-way valve, normally open	N	300	300
2x 3/2-way valve, 1x normally open, 1x normally closed	H	300	300
2x 2/2-way valve	D	230	–
1x 3/2-way valve	W	255 (2 to 4)	295 (4 to 5)
2x 3/2-way valve, normally closed, mechanical spring return	KS	230	310
2x 3/2-way valve, normally open, mechanical spring return	NS	300	300
2x 3/2-way valve, 1x normally open and 1x normally closed, mechanical spring return	HS	300	300
2x 2/2-way valve, mechanical spring return	DS	230	–

1) Value for mid-position

Valve switching times [ms]																	
Code for position function 1-32		M	J	N	K	H	B	G	E	X	W	D	I	NS	KS	HS	DS
Switching times	On	10	10	10	10	10	10	10	10	10	10	10	10	14	14	14	14
	Off	20	–	20	20	20	35	35	35	20	20	20	20	16	16	16	16
	Change-over	–	15	–	–	–	–	–	–	–	–	–	–	–	–	–	–

Valve terminals type 34 MPA-L

Technical data

Electrical data		
Nominal voltage	[V DC]	24
Operating voltage range	[V DC]	21.6 ... 26.4
Protection class to EN 60529		IP65 (for all types of signal transmission in assembled state)
Current consumption per solenoid coil at nominal voltage		
Nominal pick-up current	[mA]	50
Nominal current with current reduction	[mA]	10
Time until current reduction	[ms]	20

Electrical data – MPA-L with electrical interface for CPX terminal		
Intrinsic current consumption of valve terminal (internal electronics, without valves)		
At 24 V $U_{EL/SEN}$ ¹⁾	[mA]	Typically 13
At 24 V U_{val} ²⁾	[mA]	Typically 35
Diagnostic message		
Undervoltage U_{OFF} ³⁾	[V]	17.7 ... 17.8

- 1) Power supply for electronics and sensors
- 2) Load voltage supply for valves
- 3) Load voltage outside of function range

Valve terminals type 34 MPA-L

Technical data

Materials	
Sub-base	PA
Valve	Die-cast aluminium
Supply module	PPA
End plate	Die-cast aluminium, PA, PBT
Seals	NBR
Exhaust plate	PA
Flat plate silencer	PE
Electrical interlinking module	PBT, PA, copper alloy

Product weight	
	Approx. weight [g]
CPX module (complete)	Approx. 210
Left-hand end plate, multi-pin plug, Sub-D, 44-pin	130
Black sub-base (with seal, fibre-optic cable)	21
Electrical interlinking module for one sub-base	9
Electrical interlinking module for combination of four sub-bases	29
Supply module with seal, electrical interlinking module	51
Per valve VMPA1-M1H-M, X, W	49
Per valve VMPA1-M1H-J, N, K, H, B, G, E, D	56
Per vacant position L	24
Right-hand end plate without supply ports	105
Right-hand end plate with supply ports	160
Screw for tie rod	3
Threaded rods for tie rod, 5/45/85/205/285 mm	2/11/20/47/65
Sleeve for tie rod, 36/46/56/66 mm	6/8/9/11
Plate for ducted exhaust air/flat plate silencer	36/40
QSM-M7-4-I	4
QSM-M7-6-I	5
QS-G ³ / ₄ -8-I	22
QS-G ³ / ₄ -10-I	23
QSPKG10-3	1
QSPKG10-4	1
QSPKG10-6	2
QSPKG20-8	6
QSPKG20-10	9
QSPKG20-12	12

Valve terminals type 34 MPA-L

Technical data

Dimensions

Download CAD data → www.festo.com

Valve terminal with multi-pin plug connection

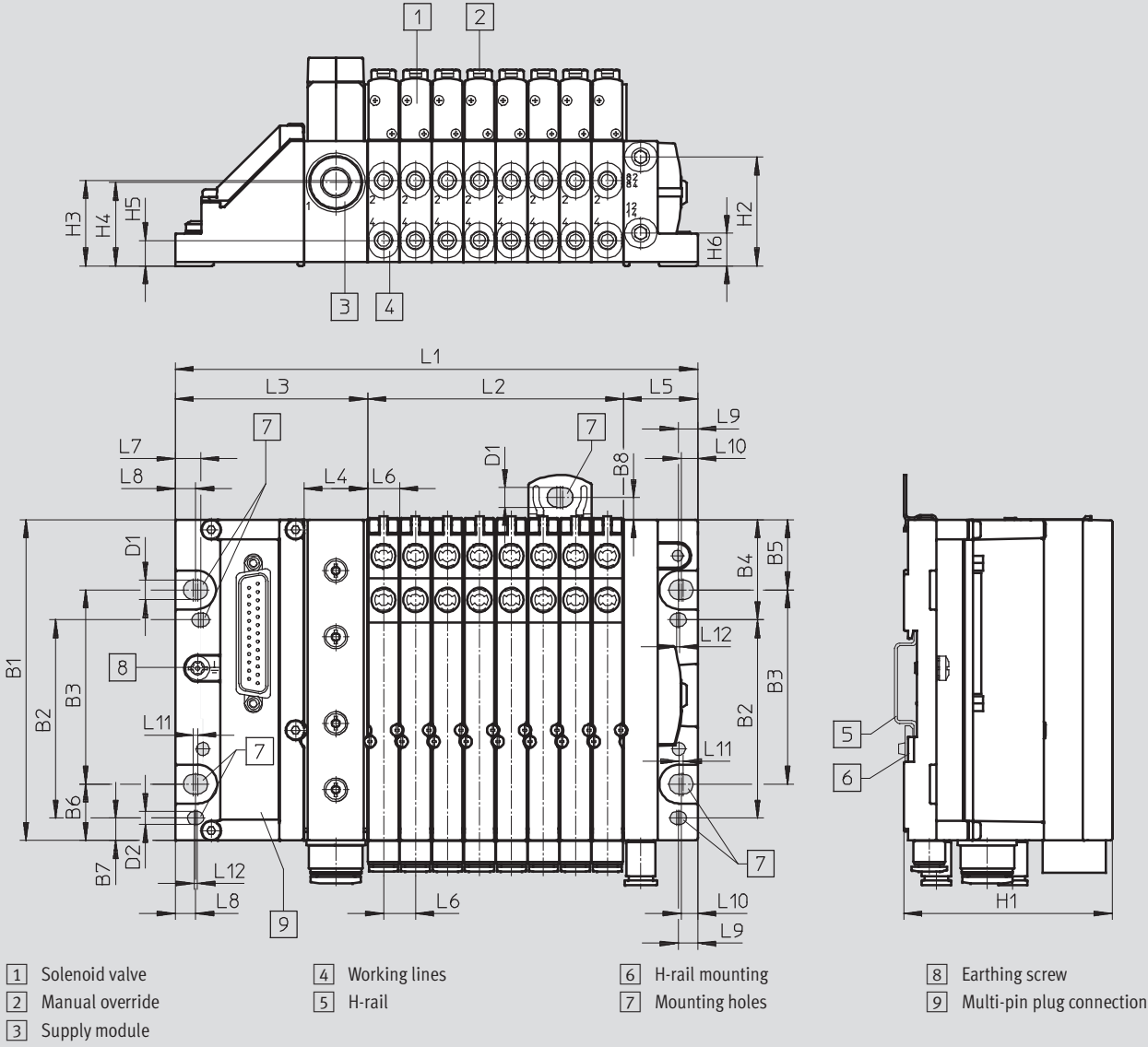

Type	L1 ¹⁾	L2 ¹⁾	L3	L4	L5	L6	L7	L8	L9	L10	L11	L12
MPA-L	89.10 + n x 10.70	n x 10.70	64.3	21.2	24.9	10.7	8.5	6.8	6.5	5.6	1.5	1

Type	B1	B2	B3	B4	B5	B6	B7	B8	H1	H2	H3	H4	H5	H6	D1	D2
MPA-L	107.3	66.3	65	33.5	23.5	18.9	7.5	7.5	69.6	36.4	28.5	27.9	8.5	10.9	6.6	4.4

1) n = number of sub-bases/valve positions

Valve terminals type 34 MPA-L

Technical data

Dimensions

Download CAD data → www.festo.com

Valve terminal with fieldbus connection

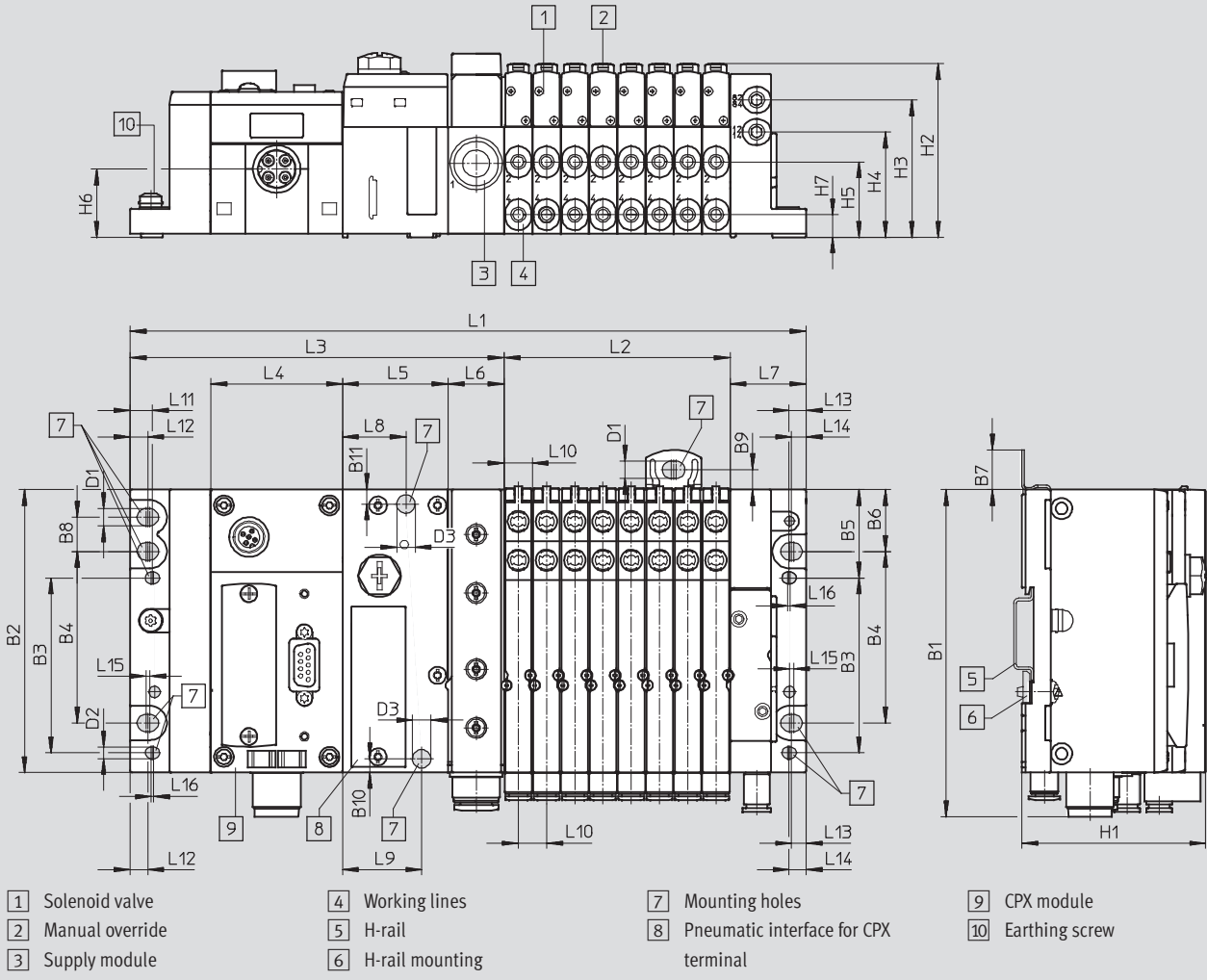

Type	L1 ¹⁾	L2 ¹⁾	L3	L4	L5	L6	L7	L8	L9	L10	L11	L12	L13	L14	D1	D2	D3
MPA-L	170.9 + n x 10.70	n x 10.70	142.1	50	40.1	21.2	28.8	24	30	10.7	8.5	6.8	5.6	6.5	6.6	4.4	7

Type	B1	B2	B3	B4	B5	B6	B7	B8	B9	B10	B11	H1	H2	H3	H4	H5	H6	H7
MPA-L	124	107.3	66.3	65	33.5	23.5	15	13	7.5	5.3	5.5	69.6	65.7	52	39.8	28.5	25.8	8.5

1) n = number of sub-bases/valve positions

Valve terminals type 34 MPA-L

Technical data

Dimensions – Cover for multi-pin plug connection

Download CAD data → www.festo.com

Cable outlet to front

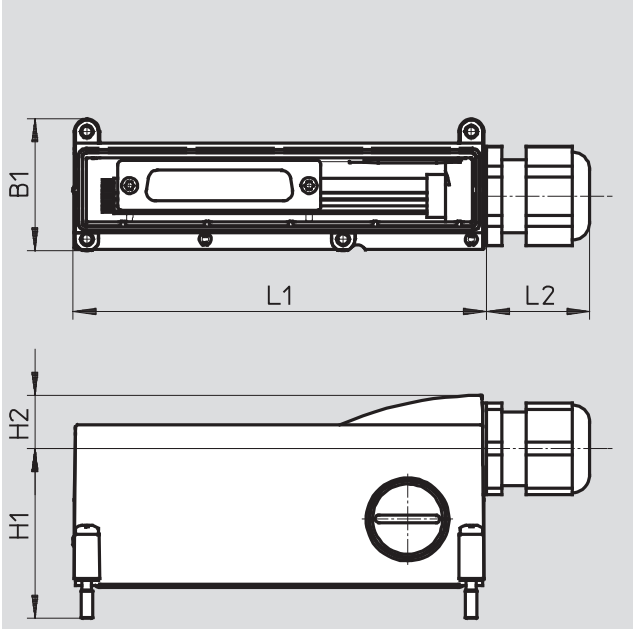

Cable outlet to side

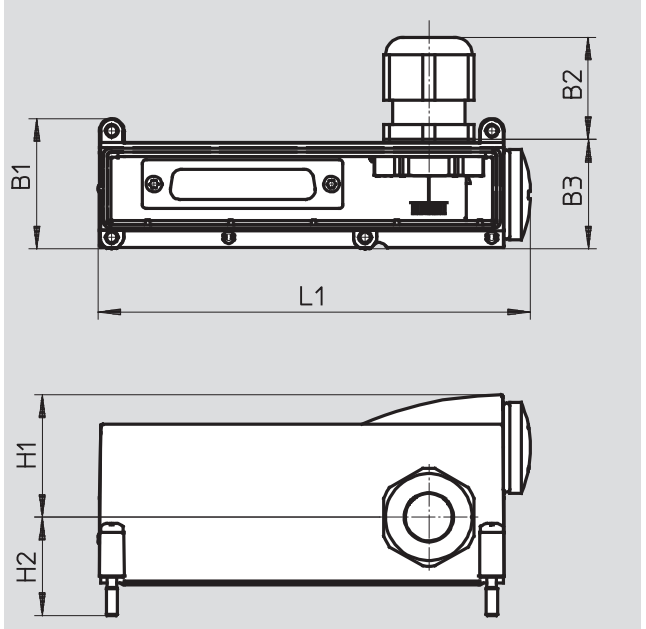

Type	L1	L2	H1	H2	B1	B2	B3
Cable outlet to front	108.3	27	44.4	14	34.5	–	–
Cable outlet to side	114.5	–	32.4	26	34.5	27	29

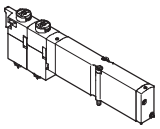
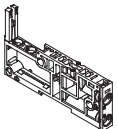
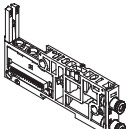

Valve terminals type 34 MPA-L

Accessories

Ordering data						
	Code	Valve function	Part No.	Type		
Sub-base valve						
	Position function 1-32: M	5/2-way valve, single solenoid	533342	VMPA1-M1H-M-PI		
	Position function 1-32: J	5/2-way valve, double solenoid	533343	VMPA1-M1H-J-PI		
	Position function 1-32: N	2x 3/2-way valve, normally open	533348	VMPA1-M1H-N-PI		
	Position function 1-32: NS	2x 3/2-way valve, normally open, mechanical spring return	556839	VMPA1-M1H-NS-PI		
	Position function 1-32: W	1x 3/2-way valve, normally open, external compressed air supply	540050	VMPA1-M1H-W-PI		
	Position function 1-32: K	2x 3/2-way valve, normally closed	533347	VMPA1-M1H-K-PI		
	Position function 1-32: KS	2x 3/2-way valve, normally closed, mechanical spring return	556838	VMPA1-M1H-KS-PI		
	Position function 1-32: H	2x 3/2-way valve, 1x normally open, 1x normally closed	533349	VMPA1-M1H-H-PI		
	Position function 1-32: HS	2x 3/2-way valve, 1x normally open, 1x normally closed, mechanical spring return	556840	VMPA1-M1H-HS-PI		
	Position function 1-32: B	5/3-way valve, mid-position pressurised	533344	VMPA1-M1H-B-PI		
	Position function 1-32: G	5/3-way valve, mid-position closed	533345	VMPA1-M1H-G-PI		
	Position function 1-32: E	5/3-way valve, mid-position exhausted	533346	VMPA1-M1H-E-PI		
	Position function 1-32: X	1x 3/2-way valve, normally closed, external compressed air supply	534415	VMPA1-M1H-X-PI		
	Position function 1-32: D	2x 2/2-way valve, normally closed	533350	VMPA1-M1H-D-PI		
	Position function 1-32: DS	2x 2/2-way valve, normally closed, mechanical spring return	556841	VMPA1-M1H-DS-PI		
Position function 1-32: I	2x 2/2-way valve, 1x normally closed, 1x normally closed, reversible	543605	VMPA1-M1H-I-PI			
Sub-base						
	Duct separation to the right of sub-base 1-40: -	Single, without electrical interlinking module, without cartridge fitting	No duct separation	-	554311	VMPAL-AP-10
	Duct separation to the right of sub-base 1-40: T		Duct 1 separated	-	554312	VMPAL-AP-10-T1
	Duct separation to the right of sub-base 1-40: TR		Ducts 3, 5 separated	-	554313	VMPAL-AP-10-T35
	Duct separation to the right of sub-base 1-40: TS		Ducts 1 and 3, 5 separated	-	554315	VMPAL-AP-10-T135
	-	Single, with electrical interlinking module, with cartridge fitting, no duct separation	Single solenoid (for 1 solenoid coil)	6 mm	560987	VMPAL-AP-10-QS6-1
				4 mm	560994	VMPAL-AP-10-QS4-1
				1/4 "	560999	VMPAL-AP-10-QS1/4 "-1
				5/32 "	561005	VMPAL-AP-10-QS5/32 "-1
			Double solenoid (for 2 solenoid coils)	6 mm	560993	VMPAL-AP-10-QS6-2
				4 mm	560988	VMPAL-AP-10-QS4-2
				1/4 "	561000	VMPAL-AP-10-QS1/4 "-2
				5/32 "	561006	VMPAL-AP-10-QS5/32 "-2
Single, with electrical interlinking module, with cartridge fitting, duct 1 separated	Single solenoid (for 1 solenoid coil)	6 mm	561011	VMPAL-AP-10-QS6-1-T1		

Valve terminals type 34 MPA-L

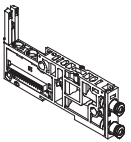
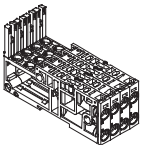
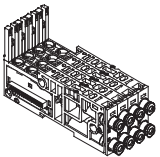
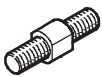
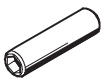
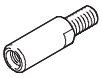
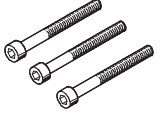





Accessories

Ordering data						
	Code	Description	Part No.	Type		
Sub-base						
	-	Single, with electrical interlinking module, with cartridge fitting, duct 1 separated	Single solenoid (for 1 solenoid coil)	4 mm	561017	VMPAL-AP-10-QS4-1-T1
				1/4"	561023	VMPAL-AP-10-QS1/4"-1-T1
				5/32"	561029	VMPAL-AP-10-QS5/32"-1-T1
			Double solenoid (for 2 solenoid coils)	6 mm	561012	VMPAL-AP-10-QS6-2-T1
				4 mm	561018	VMPAL-AP-10-QS4-2-T1
				1/4"	561024	VMPAL-AP-10-QS1/4"-2-T1
				5/32"	561030	VMPAL-AP-10-QS5/32"-2-T1
Combination of four sub-bases						
	Combination manifold block: Z	Without electrical interlinking module, without cartridge fitting	-	-	560981	VMPAL-AP-4x10
	-	With electrical interlinking module, with cartridge fitting, no duct separation, single solenoid (for 1 solenoid coil)	Tubing O.D.	6 mm	561083	VMPAL-AP-4x10QS6-1
				4 mm	561089	VMPAL-AP-4x10QS4-1
				1/4"	561095	VMPAL-AP-4x10QS1/4"-1
				5/32"	561101	VMPAL-AP-4x10QS5/32"-1
		With electrical interlinking module, with cartridge fitting, no duct separation, double solenoid (for 2 solenoid coils)	Tubing O.D.	6 mm	561084	VMPAL-AP-4x10QS6-2
				4 mm	561090	VMPAL-AP-4x10QS4-2
				1/4"	561096	VMPAL-AP-4x10QS1/4"-2
				5/32"	561102	VMPAL-AP-4x10QS5/32"-2
Tie rod						
	Tie rod: -	Threaded rod for tie rod, width across flats 5 mm The threaded rod/sleeve combination is selected based on the number and width of the individual sub-base	5 mm	561116	VMPAL-ZAS-5	
			45 mm	561117	VMPAL-ZAS-45	
			85 mm	561118	VMPAL-ZAS-85	
			125 mm	561119	VMPAL-ZAS-125	
			165 mm	561120	VMPAL-ZAS-165	
			205 mm	561121	VMPAL-ZAS-205	
			245 mm	561122	VMPAL-ZAS-245	
			285 mm	561123	VMPAL-ZAS-285	
			325 mm	561124	VMPAL-ZAS-325	
			365 mm	561125	VMPAL-ZAS-365	
			405 mm	561126	VMPAL-ZAS-405	
			445 mm	561127	VMPAL-ZAS-445	
				-	Sleeve, internal hex 4 mm	36 mm
46 mm	561136	VMPAL-ZAH-46				
56 mm	561137	VMPAL-ZAH-56				
66 mm	561138	VMPAL-ZAH-66				
	-	Tie rod extender for subsequently extending the valve terminal	For one sub-base	561139	VMPAL-ZAE-10	
			For one supply module	561141	VMPAL-ZAE-20	
			For four sub-bases	570779	VMPAL-ZAE-10-4	
	-	Screw M4x30 mm with internal hex 2.5 mm, for tie rod	3 pieces	571924	VMPAL-M-4x30	
Screw						
	-	Screw M4x10 mm and nut with internal hex 2.5 mm, for linking four sub-bases	10 pieces	561142	VMPAL-MS-4x10	

Valve terminals type 34 MPA-L

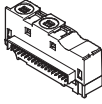
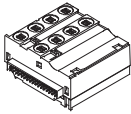
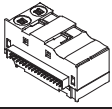
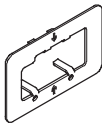
Accessories

FESTO

Ordering data				
	Code	Description	Part No.	Type
Mounting				
	-	Mounting bracket Wall brackets should be mounted max. every 13 cm on the valve terminal.	10 pieces	560949 VMPAL-BD
H-rail mounting				
	Mounting accessories: H	MPA-L with multi-pin plug connection	526032	CPX-CPA-BG-NRH
	Mounting accessories: H	MPA-L with fieldbus connection	560798	VMPAF-FB-BG-NRH
Electrical interlinking module				
	Type of module block 1-40: C	For one sub-base	Grey – single solenoid (for 1 solenoid coil)	560961 VMPAL-EVAP-10-1
	Type of module block 1-40: A	For one sub-base	Black – double solenoid (for 2 solenoid coils)	560962 VMPAL-EVAP-10-2
	Type of module block 1-40: C	For combination of four sub-bases	Grey – single solenoid (for 4 solenoid coils, 4 valve positions)	560967 VMPAL-EVAP-10-1-4
	Type of module block 1-40: A	For combination of four sub-bases	Black – double solenoid (for 8 solenoid coils, 4 valve positions)	560968 VMPAL-EVAP-10-2-4
	Type of module block 1-40: U	For supply module (signals are passed through)	Black	571011 VMPAL-EVAP-20-SP
Releasing tool				
	-	For releasing the electrical interlinking module from the sub-base	572017	VMPAL-LW
Restrictor set				
	-	Fixed restrictor, two of each size, two retainers and assembly tool	572543	VMPA1-FT-NW0.3-1.7
Fixed restrictor – Hollow bolt, for restricting the exhaust air in ducts 3 and 5, 10 pieces				
	-	qnN 3.5 ... 5.5 l/min, orange, nominal size 0.3 mm	572544	VMPA1-FT-NW0.3-10
	-	qnN 9 ... 12 l/min, green, nominal size 0.5 mm	572545	VMPA1-FT-NW0.5-10
	-	qnN 18 ... 22 l/min, purple, nominal size 0.7 mm	572546	VMPA1-FT-NW0.7-10
	-	qnN 36 ... 41 l/min, black, nominal size 1.0 mm	572547	VMPA1-FT-NW1.0-10
	-	qnN 52 ... 58 l/min, red, nominal size 1.2 mm	572548	VMPA1-FT-NW1.2-10
	-	qnN 81 ... 89 l/min, blue, nominal size 1.5 mm	572549	VMPA1-FT-NW1.5-10
	-	qnN 105 ... 115 l/min, clear, nominal size 1.7 mm	572550	VMPA1-FT-NW1.7-10
Retainer for fixed restrictor				
	-	Retainer for exhaust opening in the sub-base	572542	VMPA1-FTI-10

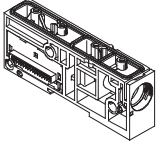
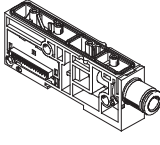
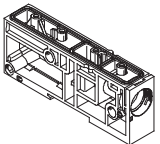
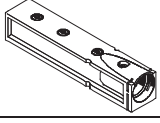
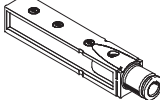
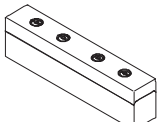

Valve terminals type 34 MPA-L

Accessories

Ordering data				
	Code	Description	Part No.	Type
Supply module				
	Type of module block 1-40: U	With electrical interlinking module, without cartridge fitting	560950	VMPAL-SP-0
	Type of module block 1-40: U	With electrical interlinking module, with cartridge fitting for tubing O.D.	8 mm	573645 VMPAL-SP-QS8
			10 mm	560951 VMPAL-SP-QS10
			12 mm	560952 VMPAL-SP-QS12
			5/16"	573646 VMPAL-SP-QS5/16"
			3/8"	560953 VMPAL-SP-QS3/8"
	Type of module block 1-40: U	Without electrical interlinking module, without cartridge fitting	570774	VMPAL-SP
Plate				
	Exhaust port: UD, UE, UF, UM, UN, UP or UG	Exhaust plate for ducted exhaust air	560956	VMPAL-EG
	Exhaust port: UE	Exhaust plate for ducted exhaust air, with cartridge fitting for tubing O.D. 10 mm	560957	VMPAL-EG-QS10
	Exhaust port: UN	Exhaust plate for ducted exhaust air, with cartridge fitting for tubing O.D. 3/8"	560959	VMPAL-EG-QS3/8"
	Exhaust port: –	Flat plate silencer	560955	VMPAL-EU

Valve terminals type 34 MPA-L

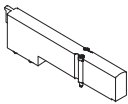

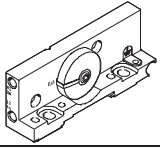
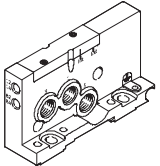
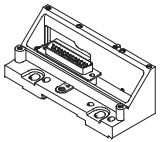
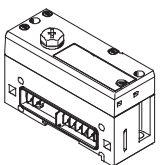
Accessories

Ordering data					
	Code	Description	Part No.	Type	
Cover					
	Position function 1-32: L	Blanking plate for vacant valve position ¹⁾	533351	VMPA1-RP	
	Manual override: N	Cover for manual override, non-detenting (10 pieces)	540897	VMPA-HBT-B	
	Manual override: V	Cover for manual override, covered (10 pieces)	540898	VMPA-HBV-B	
Right-hand end plate					
	Right-hand end plate: -	Low, with ports 12/14, 82/84, with pilot air selector for choosing the pilot air supply (internal or external)	560945	VMPAL-EPR	
	Right-hand end plate: D	High, with ports 1, 3, 5, 12/14, 82/84, with pilot air selector for choosing the pilot air supply (internal or external), reversible operation possible	560947	VMPAL-EPR-SP	
Left-hand end plate					
	Electrical connection: MS2	Electrical interface for multi-pin plug connection, IP40	Sub-D, 9-pin, 8 addresses	570777	VMPAL-EPL-SD9-IP40
	Electrical connection: MS1		Sub-D, 25-pin, 24 addresses	560940	VMPAL-EPL-SD25-IP40
	Electrical connection: MS3		Sub-D, 44-pin, 32 addresses	560941	VMPAL-EPL-SD44-IP40
	Electrical connection: MF1		Flat cable, 40-pin, 32 addresses	560942	VMPAL-EPL-FL40-IP40
	Electrical connection: MC		Terminal strip, 33-pin, 32 addresses	560943	VMPAL-EPL-KL33-IP40
	Electrical connection: MS6	Electrical interface for multi-pin plug connection	Sub-D, 25-pin, 24 addresses	560938	VMPAL-EPL-SD25
	Electrical connection: MS8		Sub-D, 44-pin, 32 addresses	560939	VMPAL-EPL-SD44
	Electrical connection: CX	Pneumatic interface for CPX terminal	32 addresses	570783	VMPAL-EPL-CPX

1) A self-adhesive label is supplied.



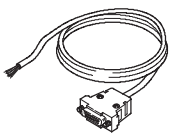
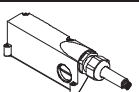
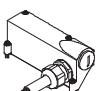
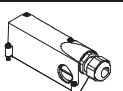

Valve terminals type 34 MPA-L

Accessories

Ordering data						
	Code	Description	Part No.	Type		
Connecting cable for multi-pin plug connection with Sub-D plug socket						
	Connecting cable: DA	Socket 9-pin, Sub-D, open cable end 9-pin	2.5 m	531184	KMP6-09P-08-2,5	
	Connecting cable: DB		5 m	531185	KMP6-09P-08-5	
	Connecting cable: DC		10 m	531186	KMP6-09P-08-10	
	–	Socket 25-pin, Sub-D, open cable end 15-pin	2.5 m	530049	KMP6-25P-12-2,5	
	–		5 m	530050	KMP6-25P-12-5	
	–		10 m	530051	KMP6-25P-12-10	
	Connecting cable: DD	Socket 25-pin, Sub-D, open cable end 25-pin	2.5 m	530046	KMP6-25P-20-2,5	
	Connecting cable: DK		5 m	530047	KMP6-25P-20-5	
	Connecting cable: DJ		10 m	530048	KMP6-25P-20-10	
	Connecting cable: CA	Cable outlet to front (only with left-hand end plate MS6)	25-pin	2.5 m	560416	VMPAL-KM-V-SD25-IP67-2,5
	Connecting cable: CB			5 m	560417	VMPAL-KM-V-SD25-IP67-5
	Connecting cable: CC			10 m	560418	VMPAL-KM-V-SD25-IP67-10
	–			Up to 30 m	562389	VMPAL-KM-V-SD25-IP67-X
	Connecting cable: CQ	Cable outlet to front (only with left-hand end plate MS6)	25-pin	2.5 m	560410	VMPAL-KMSK-V-SD25-IP67-2,5
	Connecting cable: CR			5 m	560411	VMPAL-KMSK-V-SD25-IP67-5
	Connecting cable: CS			10 m	560412	VMPAL-KMSK-V-SD25-IP67-10
	–			Up to 30 m	562391	VMPAL-KMSK-V-SD25-IP67-X
	Connecting cable: CJ	Cable outlet to front (only with left-hand end plate MS8)	44-pin	2.5 m	560422	VMPAL-KM-V-SD44-IP67-2,5
	Connecting cable: CK			5 m	560423	VMPAL-KM-V-SD44-IP67-5
	Connecting cable: CL			10 m	560424	VMPAL-KM-V-SD44-IP67-10
	–			Up to 30 m	562390	VMPAL-KM-V-SD44-IP67-X
	Connecting cable: CD	Cable outlet to side (only with left-hand end plate MS6)	25-pin	2.5 m	560419	VMPAL-KM-S-SD25-IP67-2,5
	Connecting cable: CE			5 m	560420	VMPAL-KM-S-SD25-IP67-5
	Connecting cable: CH			10 m	560421	VMPAL-KM-S-SD25-IP67-10
	–			Up to 30 m	562392	VMPAL-KM-S-SD25-IP67-X
	Connecting cable: CT	Cable outlet to side (only with left-hand end plate MS6)	25-pin	2.5 m	560413	VMPAL-KMSK-S-SD25-IP67-2,5
	Connecting cable: CU			5 m	560414	VMPAL-KMSK-S-SD25-IP67-5
	Connecting cable: CV			10 m	560415	VMPAL-KMSK-S-SD25-IP67-10
	–			Up to 30 m	562394	VMPAL-KMSK-S-SD25-IP67-X
	Connecting cable: CM	Cable outlet to side (only with left-hand end plate MS8)	44-pin	2.5 m	560425	VMPAL-KM-S-SD44-IP67-2,5
	Connecting cable: CN			5 m	560426	VMPAL-KM-S-SD44-IP67-5
	Connecting cable: CP			10 m	560427	VMPAL-KM-S-SD44-IP67-10
	–			Up to 30 m	562393	VMPAL-KM-S-SD44-IP67-X
Cover for multi-pin plug connection without connecting cable with Sub-D plug socket						
	Electrical multi-pin plug cover: EZ	Cable outlet to side or front (only with left-hand end plate MS6)	25-pin	–	560428	VMPAL-KM-SD25-IP67-0
	Electrical multi-pin plug cover: EY	Outlet either to the side or front (only with left-hand end plate MS8)	44-pin	–	560429	VMPAL-KM-SD44-IP67-0
Plug connector						
	–	Pre-assembled plug connector for flat cable, 40-pin, for flat cable cross section 0.08 ... 0.13 mm ²			570895	NECU-FCG40-K

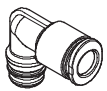
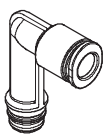

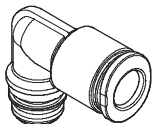
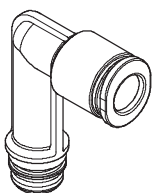



Valve terminals type 34 MPA-L

Accessories

Ordering data					
	Code	Description	Part No.	Type	
Cartridge fitting					
	Standard connection for valve size 10 mm:	AA	10 mm cartridge fitting, plastic, for working lines, connection for tubing O.D.	3 mm	132621 QSPKG10-3
		AB		4 mm	132622 QSPKG10-4
		–		6 mm	132623 QSPKG10-6
		AJ		1/8"	132852 QSPKG10-1/8-U
		AQ		5/32"	132624 QSPKG10-5/32-U
		AK		3/16"	132625 QSPKG10-3/16-U
		AL		1/4"	132626 QSPKG10-1/4-U
	–	10 mm cartridge fitting, plastic, L-shape, for working lines, connection for tubing O.D.	3 mm	132853 QSPLKG10-3	
			4 mm	132920 QSPLKG10-4	
			6 mm	132921 QSPLKG10-6	
			1/8"	132854 QSPLKG10-1/8-U	
			5/32"	132922 QSPLKG10-5/32-U	
			3/16"	132923 QSPLKG10-3/16-U	
			1/4"	132924 QSPLKG10-1/4-U	
	–	10 mm cartridge fitting, plastic, long L-shape, for working lines, connection for tubing O.D.	3 mm	132861 QSPLLKG10-3	
			4 mm	132925 QSPLLKG10-4	
			6 mm	132926 QSPLLKG10-6	
			1/8"	132862 QSPLLKG10-1/8-U	
			5/32"	132927 QSPLLKG10-5/32-U	
			3/16"	132928 QSPLLKG10-3/16-U	
			1/4"	132929 QSPLLKG10-1/4-U	
	–	20 mm cartridge fitting, plastic, for supply ports, connection for tubing O.D.	8 mm	132633 QSPKG20-8	
			10 mm	132634 QSPKG20-10	
			12 mm	132635 QSPKG20-12	
			5/16"	132636 QSPKG20-5/16-U	
			3/8"	132637 QSPKG20-3/8-U	
			1/2"	132638 QSPKG20-1/2-U	
	–	20 mm cartridge fitting, plastic, L-shape, for supply ports, connection for tubing O.D.	8 mm	132855 QSPLKG20-8	
			10 mm	132856 QSPLKG20-10	
			12 mm	132857 QSPLKG20-12	
			5/16"	132858 QSPLKG20-5/16-U	
			3/8"	132859 QSPLKG20-3/8-U	
			1/2"	132860 QSPLKG20-1/2-U	
	–	20 mm cartridge fitting, plastic, long L-shape, for supply ports, connection for tubing O.D.	8 mm	132863 QSPLLKG20-8	
			10 mm	132864 QSPLLKG20-10	
			12 mm	132865 QSPLLKG20-12	
			5/16"	132866 QSPLLKG20-5/16-U	
			3/8"	132867 QSPLLKG20-3/8-U	
			1/2"	132868 QSPLLKG20-1/2-U	
Adapter					
	Standard connection for valve size 10 mm: AG	Adapter for 10 mm cartridge fitting connection to thread M7	10 pieces	572380 VMPAL-F10-M7	
	–	Adapter for 20 mm cartridge fitting connection to thread G1/4	10 pieces	572381 VMPAL-FSP-G1/4	

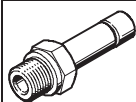

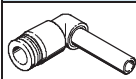
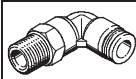

Valve terminals type 34 MPA-L

Accessories

Ordering data					
	Code	Description	Part No.	Type	
Push-in fitting					
	-	Connecting thread G $\frac{1}{4}$ with sealing ring, with internal hex, for tubing O.D.	6 mm	186108	QS-G$\frac{1}{4}$-6-I
	-	Connecting thread G $\frac{1}{4}$ with sealing ring, with external hex, for tubing O.D.	6 mm	186097	QS-G$\frac{1}{4}$-6
			8 mm	186099	QS-G$\frac{1}{4}$-8
			10 mm	186101	QS-G$\frac{1}{4}$-10
		Connecting thread G $\frac{1}{4}$, metal, with external hex, for tubing O.D.	6 mm	193411	QS-F-G$\frac{1}{4}$-6
			8 mm	193412	QS-F-G$\frac{1}{4}$-8
			10 mm	193413	QS-F-G$\frac{1}{4}$-10
			12 mm	533848	QS-F-G$\frac{1}{4}$-12
	-	Connecting thread G $\frac{1}{4}$, metal, with internal hex, for tubing O.D.	8 mm	533930	QS-F-G$\frac{1}{4}$-8-I
			10 mm	533931	QS-F-G$\frac{1}{4}$-10-I
	-	Connecting thread G $\frac{1}{4}$, metal, with push-in sleeve \varnothing	6 mm	533881	QS-F-G$\frac{1}{4}$-6H
			8 mm	533882	QS-F-G$\frac{1}{4}$-8H
			10 mm	533883	QS-F-G$\frac{1}{4}$-10H
			12 mm	533884	QS-F-G$\frac{1}{4}$-12H
	-	Connecting thread G $\frac{1}{4}$, with external hex, flame-retardant, for tubing O.D.	6 mm	186316	QS-V0-G$\frac{1}{4}$-6
			8 mm	186317	QS-V0-G$\frac{1}{4}$-8
			10 mm	186318	QS-V0-G$\frac{1}{4}$-10
Push-in L-connector					
	-	Push-in sleeve \varnothing	6 mm	153057	QSL-6H
			8 mm	153058	QSL-8H
		Long push-in sleeve \varnothing	6 mm	153066	QSL-6HL
	-	Push-in fitting with sealing ring, connecting thread G $\frac{1}{4}$, with external hex, for tubing O.D.	6 mm	186118	QSL-G$\frac{1}{4}$-6
			8 mm	186120	QSL-G$\frac{1}{4}$-8
			10 mm	186122	QSL-G$\frac{1}{4}$-10
		Push-in fitting, metal, with sealing ring, connecting thread G $\frac{1}{4}$, with external hex, for tubing O.D.	6 mm	193421	QSL-F-G$\frac{1}{4}$-6
			8 mm	193422	QSL-F-G$\frac{1}{4}$-8
			10 mm	193423	QSL-F-G$\frac{1}{4}$-10
			12 mm	533853	QSL-F-G$\frac{1}{4}$-12
		Long push-in fitting, metal, connecting thread G $\frac{1}{4}$, with external hex, for tubing O.D.	6 mm	556846	QSL-F-G$\frac{1}{4}$-6
			8 mm	556847	QSL-F-G$\frac{1}{4}$-8
			10 mm	556848	QSL-F-G$\frac{1}{4}$-10
12 mm	556849		QSL-F-G$\frac{1}{4}$-12		
	-	Push-in fitting, connecting thread G $\frac{1}{4}$, with internal hex, for tubing O.D.	6 mm	186149	QSLV-F-G$\frac{1}{4}$-6
			8 mm	186151	QSLV-F-G$\frac{1}{4}$-8

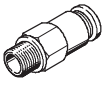
Valve terminals type 34 MPA-L

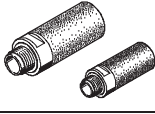
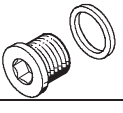
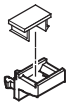
Accessories

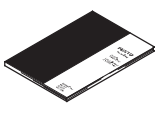
Ordering data						
	Code	Description	Part No.	Type		
Push-in fitting, self-sealing						
	-	With sealing ring, with external hex, connecting thread G $\frac{1}{4}$, for tubing O.D.	6 mm	1 piece	186296	QSK-G$\frac{1}{4}$-6
			8 mm	1 piece	186298	QSK-G$\frac{1}{4}$-8
			10 mm	1 piece	186300	QSK-G$\frac{1}{4}$-10
		With sealing ring, with external hex, L shape, connecting thread G $\frac{1}{4}$, for tubing O.D.	6 mm	1 piece	186306	QSKL-G$\frac{1}{4}$-6
			8 mm	1 piece	186308	QSKL-G$\frac{1}{4}$-8
			10 mm	1 piece	186310	QSKL-G$\frac{1}{4}$-10
Rotary push-in fitting						
	-	With external hex, connecting thread G $\frac{1}{4}$, for tubing O.D.	6 mm	1 piece	186278	QSR-G$\frac{1}{4}$-6
			8 mm	1 piece	186280	QSR-G$\frac{1}{4}$-6
		With external hex, L-shape, connecting thread G $\frac{1}{4}$, for tubing O.D.	6 mm	1 piece	186287	QSRL-G$\frac{1}{4}$-6
			8 mm	1 piece	186289	QSRL-G$\frac{1}{4}$-6
Silencer						
	-	Connecting thread M7	1 piece		161418	UC-M7
			50 pieces		534218	UC-M7-50
		Connecting thread G $\frac{1}{4}$	1 piece		165004	UC-$\frac{1}{4}$
			20 pieces		534220	UC-$\frac{1}{4}$-20
Blanking plug						
	-	Thread M7	10 pieces	174309	B-M7	
		Thread G $\frac{3}{8}$	10 pieces	3570	B-$\frac{3}{8}$	
Inscription label holder/inscription labels						
	Inscription label holder for sub-bases: TM	Holder for inscription label IBS-6x10	10 pieces	561109	VMPAL-ST-AP-10	
	-	Inscription label, 6x10 mm	64 pieces in frame	18576	IBS-6x10	
Manual						
	Documentation: DE	MPA-L Pneumatic Components	German	556353	P.BE-MPAL-DE	
	Documentation: EN		English	556354	P.BE-MPAL-EN	
	Documentation: FR		French	556356	P.BE-MPAL-FR	
	Documentation: ES		Spanish	556355	P.BE-MPAL-ES	
	Documentation: IT		Italian	556357	P.BE-MPAL-IT	
	Documentation: SV		Swedish	556358	P.BE-MPAL-SV	