

# Valve terminals type 10 CPV, Compact Performance, NPT

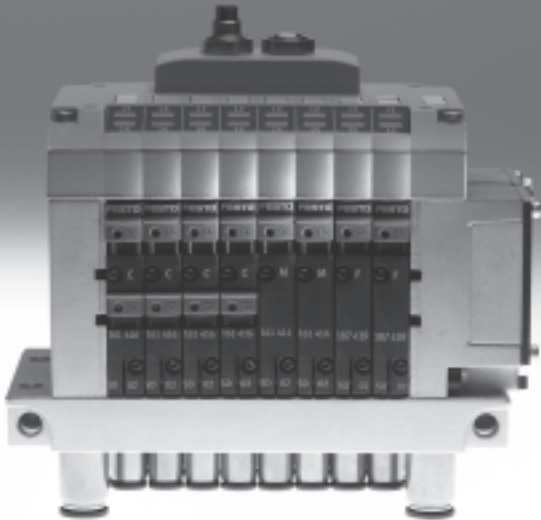

# Valve terminals type 10 CPV, Compact Performance, NPT

FESTO

Key features

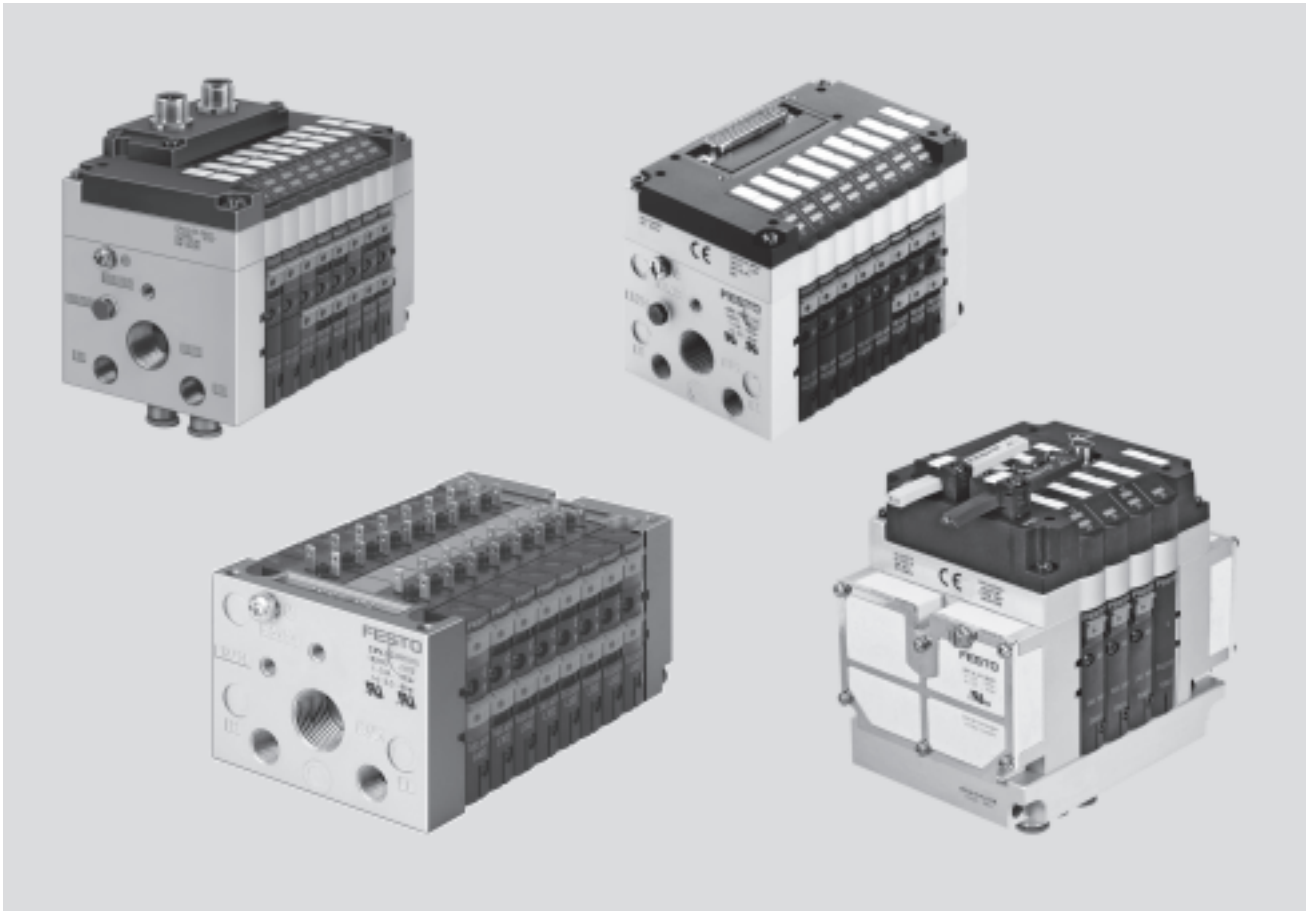

## Innovative

- Cubic design for exceptional performance and low weight
- Low installation and bus connection costs
- Ideal for decentralised machines and system structures, for example
  - in handling technology
  - in conveyor technology
  - in the packaging industry
  - in sorting systems
  - in upstream machine functions
- Integrated diagnostics, condition monitoring (Fieldbus Direct)
- A string extension for Fieldbus Direct of 8 ... 32 inputs and 8 ... 32 outputs is possible without any difficulty (version-dependent)

## Versatile

- Flexible and cost-effective connection of 2 to 8 valve slices
- Highly flexible thanks to:
  - various pneumatic functions (valve variants)
  - different pressure ranges
  - vacuum switches
  - integrated vacuum generation
  - relay plates with floating electrical outputs
- Separator plates for creating pressure zones
- Valves with integrated separation of ducts 1 and 11
- Blanking plates for future expansion

## Reliable

- LED displays
- Manual overrides for valves
- Protection class to IP65
- Protection class IP65 also in conjunction with pneumatic multiple connector plate for control cabinet assembly
- CE mark
- ATEX certification (see Technical Data)

## Easy to mount

- Ready-to-install and tested unit
- Lower selection, ordering, installation and commissioning costs
- Secure mounting on wall or H-rail
- Pneumatic multiple connector plate
  - fast assembly without the need to replace the connected tubing
- Optimised assembly for control cabinets

# Valve terminals type 10 CPV, Compact Performance, NPT

Key features

## CPV – The benefits at a glance

The CPV valve terminal has a unique design. It provides the flexible combination of pneumatic performance, electrical connection technologies and a wide range of mounting options. The pneumatic multiple connector plate supports space-saving installation in control cabinets. In many cases the valve terminal can be installed in the previously unused wall area of the control cabinet. There is no need to connect the valves in the control cabinet. All tube couplings can be laid externally. Instead of individual holes,

the pneumatic multiple connector plate requires only one rectangular cutout.

The generously sized flow ducts and powerful flat plate silencers ensure high flow rates.

All valves are in the form of valve slices. They are optimised for flow performance and are also extremely compact. Two functions per valve slice (e.g. 2x 3/2-way valves) mean that twice the component density can be achieved. This saves space and reduces costs.

The cubic design permits exceptional performance yet a comparatively low weight. The benefits of this design are obvious when the valve terminal is used on a drive in a moving installation.

However, robustness must not be sacrificed in favour of compactness.

The connecting threads and mounting attachments are metal.

The manual override for the valves can be adapted for different operating situations. If, for example, a detenting manual override is required for setting-up mode, the manual override

can be easily converted for that application in a way that rules out operational errors.

The clear, large labelling system also contributes to the safe operation of the valve terminal.

A particular plus is the range of electrical connection technologies supported. All types of valve actuation are possible, from individual valve connections up to bus systems with versatile expansion options. The integration of electrical input and output modules permits cost-effective solutions within the different installation concepts.

## The design principle

The cubic design provides a clearly assigned function on each side. Thus, for example, the electrical connection is mounted on the top.

An optional inscription label holder can be placed on the front of the valve terminal.

The different combination options ensure the optimum solution for the task at hand.

- Compressed air supply connections on the left, right or underneath
- Pneumatic working lines and function blocks (vertical stacking) underneath

- Manual operation/identification on the front
- Electrical connection surface on the top
- Mounting surface at the back or the front via a pneumatic multiple connector plate

# Valve terminals type 10 CPV, Compact Performance, NPT

## Key features

**Main features**

- Simple electrical connections:
  - Individual connection/ET200X/ET200pro
  - Multi-pin plug
  - AS-interface
  - Installation system CP/CPI
  - Fieldbus Direct
- Operating voltage connection
- Quick mounting:
  - Directly using screws
  - On an H-rail
  - Via the pneumatic multiple connector plate
- Robust metal thread or pre-assembled QS push-in fittings for inch-size tubes
- Inscription labels
- Reduced downtimes:
  - On-the-spot diagnostics via LEDs
- Reliable operation:
  - Manual override, non-detenting, detenting or blocked
- Comprehensive range of valve functions, pressure zone creation, blanking plates
- Width
  - 10 mm
  - 14 mm
  - 18 mm

**Equipment options**

Valve functions

<ul style="list-style-type: none"> <li>• 5/2-way valve, single solenoid</li> <li>• 5/2-way valve (with duct separation 1, 11), single solenoid</li> <li>• 5/2-way valve, single solenoid, fast-switching</li> <li>• 5/2-way valve, double solenoid</li> <li>• 5/2-way valve (with duct separation 1, 11), double-solenoid</li> <li>• 2x 3/2-way valve, normally closed</li> <li>• 2x 3/2-way valve (with duct separation 1, 11), normally closed</li> </ul>	<ul style="list-style-type: none"> <li>• 2x 3/2-way valve, normally open</li> <li>• 2x 3/2-way valve (with duct separation 1, 11), normally open</li> <li>• 2x 3/2-way valve, 1x normally open, 1x closed</li> <li>• 2x 3/2-way valve, (with duct separation 1, 11) 1x normally open, 1x closed</li> <li>• 2x 3/2-way valve, normally closed, integrated back pressure protection</li> </ul>	<ul style="list-style-type: none"> <li>• 5/3-way valve, mid-position closed</li> <li>• 2x 2/2-way valve, normally closed</li> <li>• 2x 2/2-way valve (with duct separation 1, 11), normally closed</li> <li>• 2x 2/2-way valve, 1x normally open, 1x closed</li> <li>• 2x 2/2-way valve, (with duct separation 1, 11) 1x normally open, 1x closed</li> </ul>	<ul style="list-style-type: none"> <li>• Vacuum generator</li> <li>• Vacuum generator and 2/2-way valve with ejector pulse</li> <li>• On some terminals a relay plate with two floating contacts can be chosen instead of a valve sub-base</li> </ul>
---	--	--	---

**Special features**

Individual connection	Multi-pin plug connection	AS-interface	Installation system CP/CPI
<ul style="list-style-type: none"> <li>• 2 ... 8 valve positions, max. 16 solenoid coils</li> </ul>	<ul style="list-style-type: none"> <li>• 4, 6 or 8 valve positions, max. 16 solenoid coils</li> </ul>	<ul style="list-style-type: none"> <li>• 2, 4 or 8 valve positions, max. 8 solenoid coils</li> <li>• 4 or 8 inputs for 4 or 8 valve positions</li> </ul>	<ul style="list-style-type: none"> <li>• 4, 6 or 8 valve positions, max. 16 solenoid coils</li> <li>• CP/CPI string extension enables further valve terminals and I/O modules with CP/CPI function to be connected</li> </ul>

Fieldbus Direct	Electrical connection for ET200X/ET200pro
<ul style="list-style-type: none"> <li>• 8 valve positions, max. 16 solenoid coils</li> <li>• CP/CPI string extension enables further valve terminals and I/O modules with CP/CPI functions to be connected</li> </ul>	<ul style="list-style-type: none"> <li>• 8 valve positions, max. 16 solenoid coils</li> </ul> <div style="border: 1px solid black; padding: 5px; margin-top: 10px;"> <p><b>Note</b></p> <p>A moulded seal is required for the valve terminal CPV10-ET200pro in order to achieve the IP protection class.</p> <p>The moulded seal CPV10-...GE-8 or CPV14-...GE-8 must be ordered separately.</p> </div>

# Valve terminals type 10 CPV, Compact Performance, NPT

Key features

## Electrical connections

### Individual connection

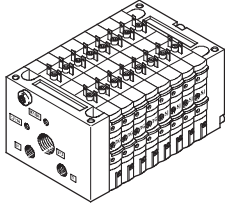

Connection is independent of the control technology used and is flexible thanks to pre-assembled cables. This ensures correct polarity during installation. The connector plug is equipped with an LED that indicates switching status, and an overvoltage

protective circuit. It also features a built-in current reduction circuit. Individual connection permits the selection of 2 to 16 solenoid coils (divided between 2 to 8 valve slices, odd numbers also possible).

An intrinsically safe version rounds off the range.

Additional information  
 → Internet: cpv10-ex-vi

### Multi-pin plug connection

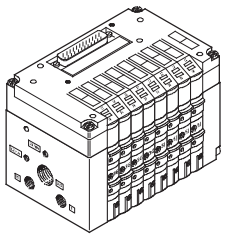

Control signals from the controller to the valve terminal are transmitted via a pre-assembled multi-wire cable, which substantially reduces

installation time. The current reduction circuit for the valves is also integrated in the multi-pin plug connection.

This valve terminal can be equipped with 4 to 16 solenoid coils (4, 6 or 8 valve slices).

### AS-interface connection

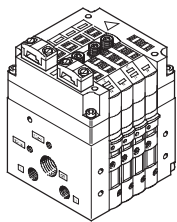
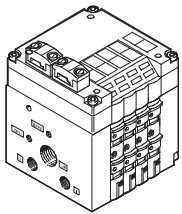

A special feature of the AS-interface is the simultaneous transmission of data and supply power via a two-wire cable. The encoded cable profile prevents connection with incorrect polarity. If the valves have to be disconnected from mains power in an emergency, they can also be supplied with electrical power via a separate connection. Two versions are available for valve terminals for A/B operation.

The valve terminal with AS-interface is available in the following versions:

- Without inputs, with two or four valve slices (max. 4 solenoid coils) and additional power supply
- With four inputs and four valve slices (max. 8 solenoid coils)
- With four or eight inputs and four or eight valve slices (max. 8 solenoid coils) and additional power supply

- With four or eight inputs and four or eight valve slices including vacant position or positions (max. 6 solenoid coils for A/B operation to SPEC.2.1) and additional power supply. In contrast to the SPEC 2.1 version, eight solenoid coils can be connected in A/B operation to SPEC. 3.0 with profile 7.A.7.

Additional information  
 → Internet: as-interface

 Note  
 Valve terminals to SPEC.2.1 cannot be operated on a master to SPEC.3.0 with profile 7.A.7.

# Valve terminals type 10 CPV, Compact Performance, NPT

FESTO

Key features

## Electrical connections

Installation system CP/CPI

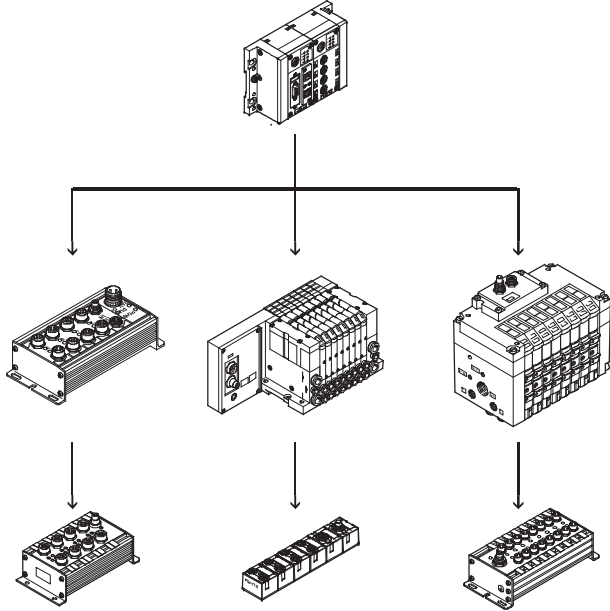

Valve terminals with fieldbus connection are intended for connection to higher-order fieldbus nodes or to control blocks. A fieldbus node or control block also enables the connection of decentralised input/output modules. The following fieldbus protocols are supported:

- Festo fieldbus, ABB CS31, Moeller Suconet K
- Interbus
- Allen Bradley (1771 RIO)
- DeviceNet
- Profibus DP
- CANopen
- CC-Link

Four strings with up to 32 inputs and 32 outputs (version-dependent) can be connected to a fieldbus node or control block. The CPV valve terminal is treated like an output module with up to 8 outputs (4, 6 or 8 valve slices or 4 to 16 solenoid coils per terminal). The connecting cables transmit all required electrical signals (control signals, operating voltage for the internal electronics of the modules and load voltage supply for connected valves).

Additional information  
 → Internet: ctec

## Fieldbus Direct

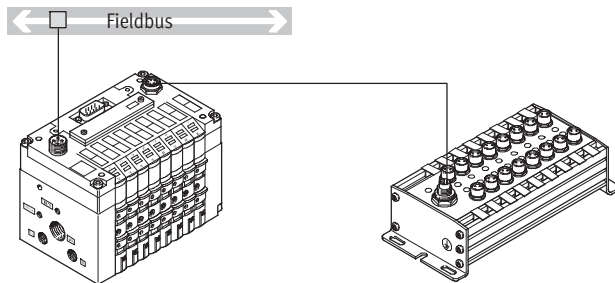

Fieldbus Direct is a system for the compact connection of a CPV, CPV-SC, CPA-SC or CDVI valve terminal to different fieldbus standards such as Profibus and DeviceNet.

The fieldbus node is directly integrated in the electrical interface of the valve terminal and therefore takes up only a minimal amount of space. The CPI string extension option allows the functions and components of the CPI system to be used.

The new high-performance CPI string extension offers up to 4 supplementary CPI modules, combined with CP or CPI-compatible valve terminals for extension purposes. The Fieldbus Direct system can be expanded by 8 ... 32 inputs and 8 ... 32 outputs without any difficulty.

## ET200X/ET200pro pneumatic interface for CPV10 and CPV14

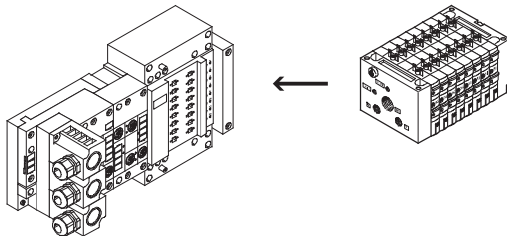

Adaptation of the CPV valve terminal to the input/output module ET200X/ET200pro from Siemens: the combination of the functional module of the ET200X/ET200pro and the pneumatic functions of the CPV valve terminal provides a highly integratable automation solution for systems using electrical and pneumatic drives with:

- 8 valve slices for up to 16 CPV valves
- Fast and secure contacting to IP65
- CPV10 and CPV14 valve terminals
- Not permitted for CPV10-EX-VI
- High IP65/IP67 protection
- Modular design

# Valve terminals type 10 CPV, Compact Performance, NPT

Selection and development

## Valve terminal configurator

Online via: → [www.festo.com](http://www.festo.com)

The appropriate valve terminal can be chosen quickly and easily using the online catalogue. This includes an easy-to-use valve terminal configurator, which makes it much easier to find the right product.

The valve terminals are fully assembled according to your order specification and are individually tested. This reduces assembly and installation time to a minimum.

You order a valve terminal type 10 using the order code.

Ordering system for type 10  
→ Internet: type 10

## 2D/3D CAD data

Online via: → [www.festo.com](http://www.festo.com)

You can request the CAD data for a valve terminal you have configured. To do so, perform the product search as described above. Go to the shopping basket and click on the CAD

icon (compass). On the next page you can generate a 3D preview or request another data format of your choice by e-mail.

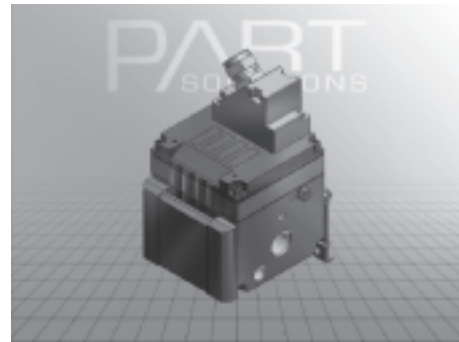

# Valve terminals type 10 CPV, Compact Performance, NPT

FESTO

Peripherals overview

## Overview – CPV valve terminal

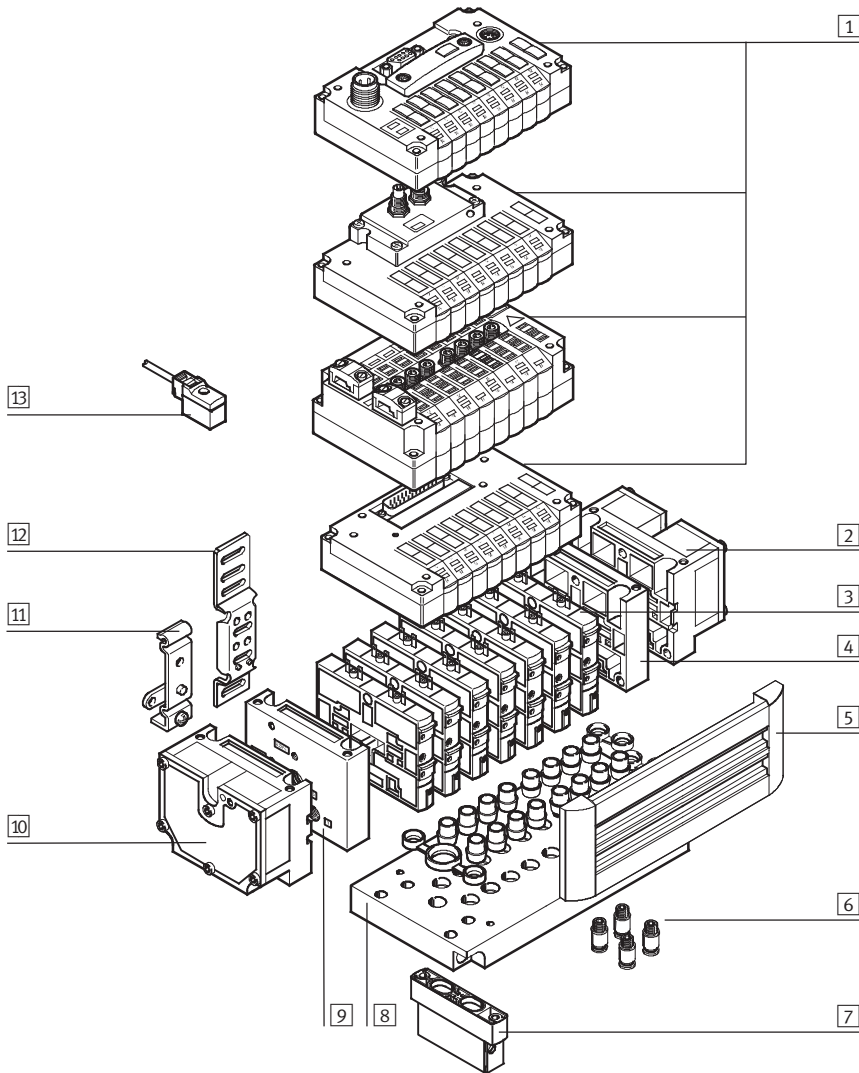

- |   |   |  |  |
|---|---|--|--|
| <p>1 Basic electrical unit (Fieldbus Direct, CP/CPI installation system, AS-interface, multi-pin plug, individual connection)</p> | <p>3 Comprehensive range of valve functions</p>   | <p>7 Function block (vertical stacking)</p>  | <p>10 Left-hand end plate with flat plate silencer</p>     |
| <p>2 Right-hand end plate with flat plate silencer</p>  | <p>4 Right-hand end plate (threaded connections not in conjunction with pneumatic multiple connector plate)</p> | <p>8 Pneumatic multiple connector plate</p>  | <p>11 H-rail mounting</p>                                  |
|   | <p>5 Holder for inscription label</p>   | <p>9 Left-hand end plate (threaded connections not in conjunction with pneumatic multiple connector plate)</p> | <p>12 Wall mounting</p>                                    |
|   | <p>6 QS push-in fittings for inch-size tubes</p>  |  | <p>13 Plug socket with cable for individual connection</p> |



# Valve terminals type 10 CPV, Compact Performance, NPT

Key features – Pneumatic components

## Valves

CPV valves are valves with integrated sub-base, i.e. in addition to the valve function they contain all of the pneumatic ducts for supply, exhaust and the working lines. The supply ducts are a central component of the valve

slices and allow a direct flow of air through the valve slices. This helps achieve maximum flow rates. All valves have a pneumatic pilot control for optimising performance. The valve function is based on

a piston spool system with a patented sealing principle that guarantees its suitability for a wide range of applications as well as a long service life. The pneumatic components and

functions are always identical for all actuator types. Most functions are also available in the various valve sizes (grid dimensions). Restrictions are noted where applicable.

Valve function					
Code	Circuit symbol	Size			Description
		10	14	18	
M, MK		■	■	■	5/2-way valve, single solenoid <ul style="list-style-type: none"> <li>• Pneumatic spring return</li> <li>• Piston spool valve</li> <li>• With duct separation 1, 11 for valve MK</li> <li>• Size 18 only available for valve M</li> </ul>
F		■	-	-	5/2-way valve, single solenoid <ul style="list-style-type: none"> <li>• Pneumatic spring return</li> <li>• Piston spool valve</li> <li>• Fast switching</li> </ul>
J, JK		■	■	■	5/2-way valve, double solenoid <ul style="list-style-type: none"> <li>• Piston spool valve</li> <li>• With duct separation 1, 11 for valve JK</li> <li>• Size 18 only available for valve J</li> </ul>
C, CK		■	■	■	2x 3/2-way valve, single solenoid <ul style="list-style-type: none"> <li>• Normally closed</li> <li>• Pneumatic spring return</li> <li>• Piston spool valve</li> <li>• With duct separation 1, 11 for valve CK</li> <li>• Size 18 only available for valve C</li> </ul>
CY		■	-	-	2x 3/2-way valve, single solenoid <ul style="list-style-type: none"> <li>• Normally closed</li> <li>• Pneumatic spring return</li> <li>• Integrated back pressure protection</li> <li>• Piston spool valve</li> <li>• Not suitable for vacuum</li> </ul> <p> Note</p> <p>The valve terminal must be operated with external pilot air supply if it is necessary to ensure that the back pressure flaps are closed securely in the event of a sudden drop in operating pressure or if the operating pressure is switched off.</p>

# Valve terminals type 10 CPV, Compact Performance, NPT

Key features – Pneumatic components

Valve function					
Code	Circuit symbol	Size			Description
		10	14	18	
N, NK		■	■	■	<p>2x 3/2-way valve, single solenoid</p> <ul style="list-style-type: none"> <li>• Normally open</li> <li>• Pneumatic spring return</li> <li>• Piston spool valve</li> <li>• With duct separation 1, 11 for valve NK</li> <li>• Size 18 only available for valve N</li> </ul> <p>The function of a 5/3-way valve with mid-position pressurised can be implemented with these valves with initial position open.</p>
H, HK		■	■	■	<p>2x 3/2-way valve, single solenoid</p> <ul style="list-style-type: none"> <li>• Normal position <ul style="list-style-type: none"> <li>– 1x open (pilot control 12)</li> <li>– 1x closed (pilot control 14)</li> </ul> </li> <li>• Pneumatic spring return</li> <li>• Piston spool valve</li> <li>• With duct separation 1, 11 for valve HK</li> <li>• Size 18 only available for valve H</li> </ul> <p>For optimised cylinder movement. Corresponds to valve function M with simultaneous actuation of both solenoid coils (5/2-way, single solenoid). Since the piston area on each side can be pressurised or exhausted separately, it means that the cylinder can move faster.</p>
G		-	-	■	<p>5/3-way valve, mid-position closed</p> <ul style="list-style-type: none"> <li>• Mechanical spring return</li> <li>• Piston spool valve</li> </ul>
		■	■	-	<p>5/3G<sup>1)</sup> function, mid-position closed</p> <p>For size 10 and 14</p> <p>The valve function “mid-position closed” is created from one 2x 3/2-way valve, normally closed (code C).</p> <p>The valve kit CPV10-BS-5/3G-M7 or CPV14-BS-5/3G-1/8 (incorporating a double piloted non-return valve function) is used for this. This valve kit is intended for applications with one working pressure level per valve slice, i.e. it must not be used in dual-pressure applications (where the pressure levels at port 1 and 11 are different).</p> <p>If other valve slices are to be used in dual-pressure mode, then the valve slice equipped with the 5/3G valve kit must be separated from compressed air duct 1 and 11 by means of a separator plate (code T).</p> <p>Not in first or last valve position with pneumatic multiple connector plate P and M. Cannot be used with pneumatic multiple connector plate GQC and GQD.</p> <ul style="list-style-type: none"> <li>• Piston spool valve</li> </ul>

1) Cannot be assembled in conjunction with the control cabinet version of the pneumatic multiple connector plate CPV10-VI-P...C or CPV10-VI-P...D

Note

A filter must be installed upstream of valves operated in vacuum mode. This prevents any foreign matter in the intake air getting into the valve (e.g. when operating a suction cup).

# Valve terminals type 10 CPV, Compact Performance, NPT

Key features – Pneumatic components

Valve function					
Code	Circuit symbol	Size			Description
		10	14	18	
–		■	■	■	5/3E function, mid-position exhausted The valve function “mid-position exhausted” is created using a 2x 3/2-way valve, normally closed (code C, CK). <ul style="list-style-type: none"> <li>• Pneumatic spring return</li> <li>• Piston spool valve</li> </ul>
–		■	■	■	5/3B function, mid-position pressurised The valve function “mid-position pressurised” is created using a 2x 3/2-way valve, normally open (code N, NK). <ul style="list-style-type: none"> <li>• Pneumatic spring return</li> <li>• Piston spool valve</li> </ul>
D, DK		■	■	■	2x 2/2-way valve, single solenoid <ul style="list-style-type: none"> <li>• Normally closed</li> <li>• Pneumatic spring return</li> <li>• Piston spool valve</li> <li>• With duct separation 1, 11 for valve DK</li> <li>• Size 18 only available for valve D</li> </ul>
I, IK		■	■	■	2x 2/2-way valve, single solenoid <ul style="list-style-type: none"> <li>• Normal position                             <ul style="list-style-type: none"> <li>– 1x open (control side 12)</li> <li>– 1x closed (control side 14)</li> </ul> </li> <li>• Pneumatic spring return</li> <li>• Piston spool valve</li> <li>• With duct separation 1, 11 for valve IK</li> <li>• Size 18 only available for valve I</li> </ul>
R	Relay plate (2 floating contacts) 	■	■	–	A relay plate (code R) with (N/O contacts) can also be used instead of a valve slice. Each relay plate has two relays for actuating two electrically isolated outputs. Load capacity: 24 V DC, 1 A. <ul style="list-style-type: none"> <li>• Connecting cable KRP-1-24-...</li> <li>• An inscription label holder cannot be used</li> </ul>

# Valve terminals type 10 CPV, Compact Performance, NPT

Key features – Pneumatic components

Additional pneumatic functions					
Code	Circuit symbol	Size			Description
		10	14	18	
A	<p>Vacuum generator</p>	■	■	■	<p>Vacuum generation according to the ejector principle.</p> <p>Vacuum slices of different widths for different suction capacities.</p> <p>Combinations with a number of vacuum slices and/or directional control function slices are possible on the same valve terminal.</p> <p>In principle, an open connection is formed between the exhaust duct 3/5 and the working line 4. When the nozzle is not switched, the resulting back pressure in the exhaust duct flows back into the working line. When the nozzle is switched, the vacuum can be greatly reduced by the resulting back pressure.</p>
E	<p>Vacuum generator with ejector pulse</p>	■	■	■	<p>This effect is improved through optimised exhausting. It does not occur where there is only one vacuum generator per valve terminal and where separator plates (code S) are used for separation.</p> <p>Vacuum generator on pilot side 14</p> <ul style="list-style-type: none"> <li>• Reset via mechanical spring and pneumatic spring</li> <li>• Ejector pulse on pilot side 12 (code E)</li> <li>• Note air supply and exhaust when using more than two vacuum generators</li> </ul>
P	<p>Input (valve side)</p> <p>Output (cylinder side)</p>	■	■	–	<p>2x one-way flow control valve, supply air flow control</p> <p>Module (actuator) for direct flange mounting on the CPV valves.</p> <p>Also suitable for pneumatic multiple connector plates.</p> <p>Different valve actuators cannot be combined.</p> <p>Not with valve function G</p> <ul style="list-style-type: none"> <li>• Not in first or last valve position with accessories M, P, V (pneumatic multiple connector plate)</li> <li>• Cannot be used with accessories GQC and GQD (pneumatic multiple connector plate)</li> </ul>
Q	<p>Input (valve side)</p> <p>Output (cylinder side)</p>	■	■	–	<p>2x one-way flow control valve, exhaust air flow control</p> <p>Module (actuator) for direct flange mounting on the CPV valves.</p> <p>Also suitable for pneumatic multiple connector plates.</p> <p>Different valve actuators cannot be combined.</p> <p>Not with valve function G</p> <ul style="list-style-type: none"> <li>• Not in first or last valve position with accessories M, P, V (pneumatic multiple connector plate)</li> <li>• Cannot be used with accessories GQC and GQD (pneumatic multiple connector plate)</li> </ul>
V	<p>Input (valve side)</p> <p>Output (cylinder side)</p>	■	■	–	<p>One-way flow control valve for vacuum</p> <p>The module CPV-...-BS-GRZ-V-... has a built-in non-return valve as well as a flow control function for adjusting the ejector pulse. The non-return valve serves to temporarily maintain the vacuum, even if the vacuum generator is switched off.</p> <p>The module is suitable for vacuum generators (code A, E).</p> <ul style="list-style-type: none"> <li>• Not in first or last valve position with accessories M, P, V (pneumatic multiple connector plate)</li> <li>• Cannot be used with accessories GQC and GQD (pneumatic multiple connector plate)</li> </ul>

# Valve terminals type 10 CPV, Compact Performance, NPT

Key features – Pneumatic components

## Creating pressure zones

Different pressures at port 1 and 11 result in two pressure levels per valve. This means, for example, that a cylinder drive can be advanced using high pressure and retracted using low pressure to save energy.

The maximum number of pressure zones possible is determined by the combination of the following components:

- Use of a separator plate
- End plate pair type
- Valve slice type
- Number of valve slices

The CPV valve terminal can be divided into 2 to 4 pressure zones with the aid of separator plates or valves with integrated duct separation.

Separator plates/valves with integrated duct separation					
Code	Graphical symbol	Size			Note
		10	14	18	
T	Separator plate for creating pressure zones, supply duct 1 and 11 separated  	■	■	■	A separator plate (code T) is used to separate the duct for the air supply (port 1 and 11) to provide two pressure zones. <ul style="list-style-type: none"> <li>• Not in first or last valve position</li> <li>• Not with compressed air supply A, B, C, D, U, V, W, X</li> </ul>
S	Separator plate for creating pressure zones, supply duct 1, 11 and exhaust 3/5 separated  	■	■	■	The separator plate (code S) separates the exhaust duct 3/5 as well as the supply duct 1 and 11. This plate should be used if one of the pressure zones is under vacuum to avoid any effects on the vacuum or to prevent back pressure on neighbouring valve functions. <ul style="list-style-type: none"> <li>• Not in first or last valve position</li> <li>• Not with compressed air supply A, B, C, D, U, V, W, X (single-side compressed air supply)</li> </ul>
L	Blanking plate (vacant position)  	■	■	■	A blanking plate (code L) is used to create a vacant position where a valve can be positioned at a later date.
MK, JK, CK, NK, DK, IK	Valve with integrated separation of ducts 1 and 11  	■	■	-	With these valves the ducts for the air supply (port 1 and 11) are closed to the right-hand side of the valve with a cast membrane. The advantage of using this instead of a separator plate is that no valve location is occupied by a separator plate.

# Valve terminals type 10 CPV, Compact Performance, NPT

Key features – Pneumatic components

## Examples: Compressed air supply

External pilot air supply, flat plate silencer at both ends

Compressed air supply via pneumatic multiple connector plate:  
code H

The diagram opposite shows an example of the configuration and connection of the compressed air supply with external pilot air supply. Port 12/14 on the pneumatic multiple connector plate is equipped with a fitting for this purpose. Ports 3/5 and 82/84 are vented via the flat plate silencers. One separating seal each can be optionally used to create pressure zones.

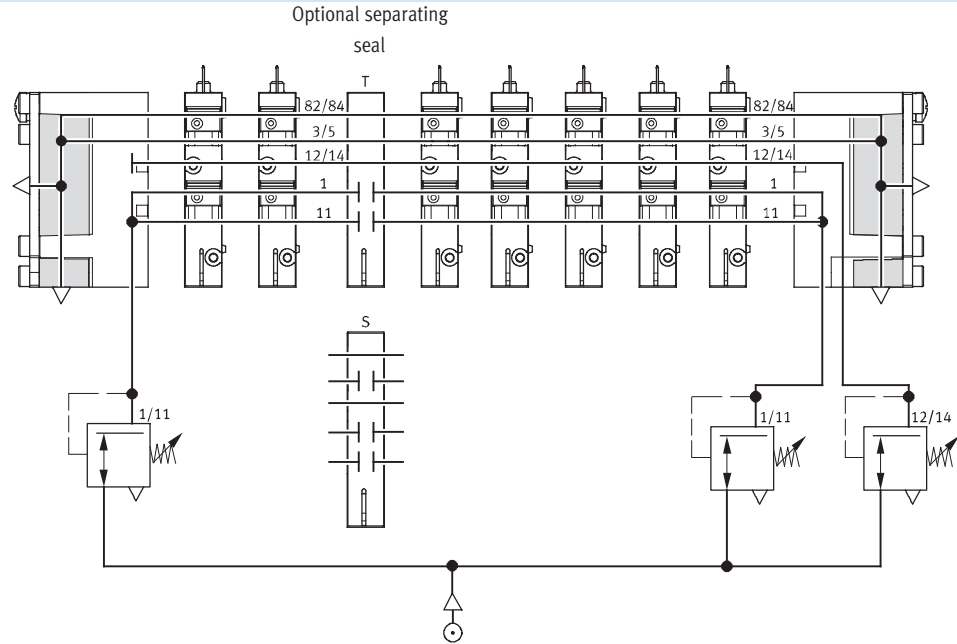

## Internal pilot air supply, ducted exhaust air or threaded silencer

Compressed air supply via end plates:  
code Z

The diagram opposite shows an example of the configuration and connection of the compressed air supply with internal pilot air supply. The pilot air is branched at the right-hand end plate of port 1 or 11. Ports 3/5 and 82/84 are vented via the threaded silencer.

The pilot air is branched at the right-hand end plate of port 1 or 11. Ports 3/5 and 82/84 are vented via the threaded silencer.

One separating seal each can be optionally used to create pressure zones.

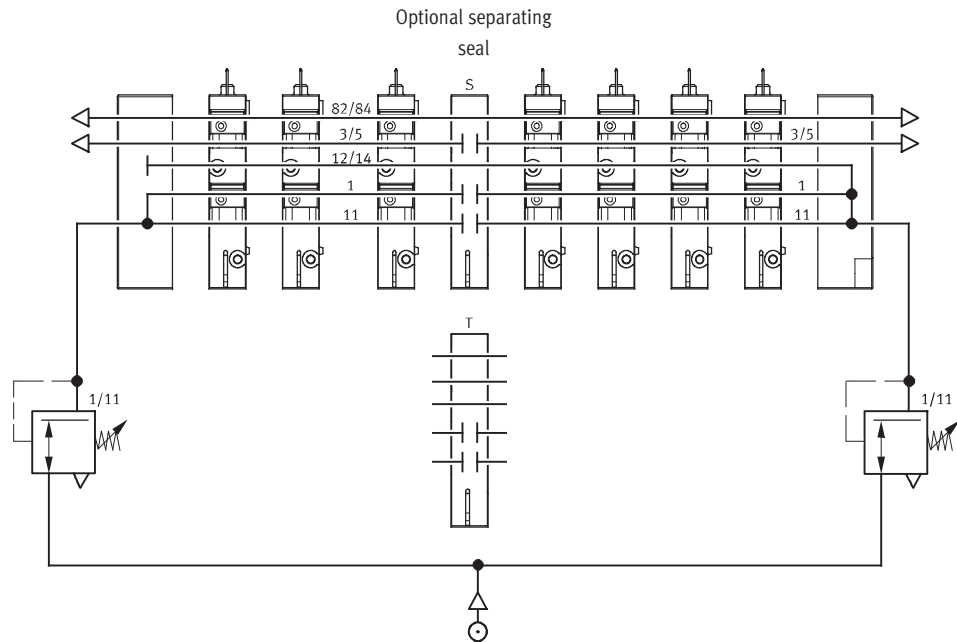

# Valve terminals type 10 CPV, Compact Performance, NPT

Key features – Pneumatic components

## Example: Creating pressure zones

CPV with separator plate T

With the CPV valve terminals up to four pressure zones can be implemented. The diagram shows an example of the configuration and connection of four pressure zones using separator plate code T – with external pilot air supply.

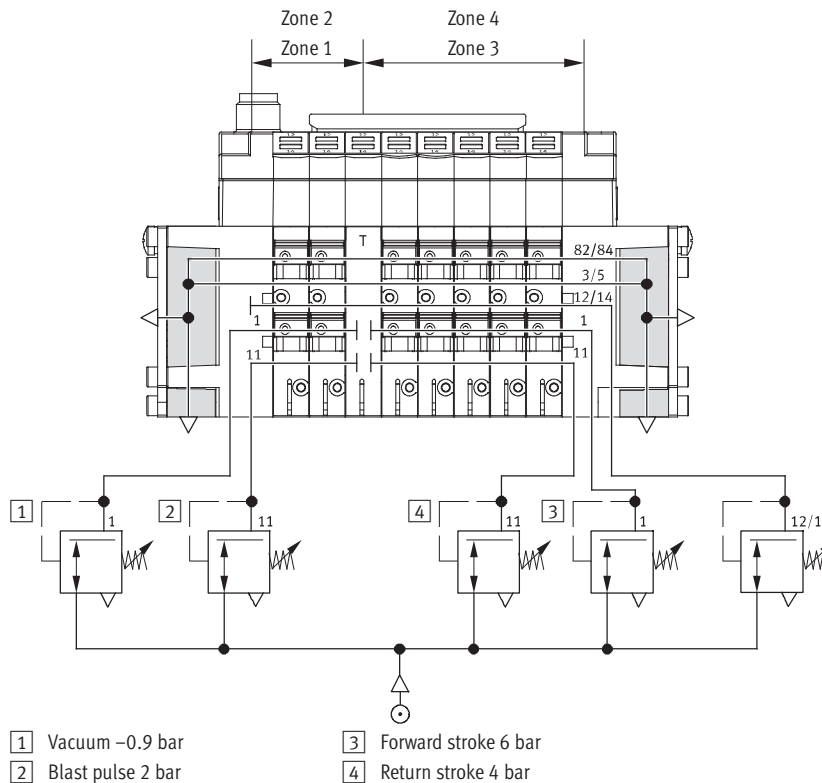

## CPV with integrated separation of ducts 1 and 11 with valves ...K

With the CPV valve terminals up to four pressure zones can be implemented. The diagram shows an example of the configuration and connection of four pressure zones with external pilot air supply and the use of a valve ...K with integrated separation of ducts 1 and 11.

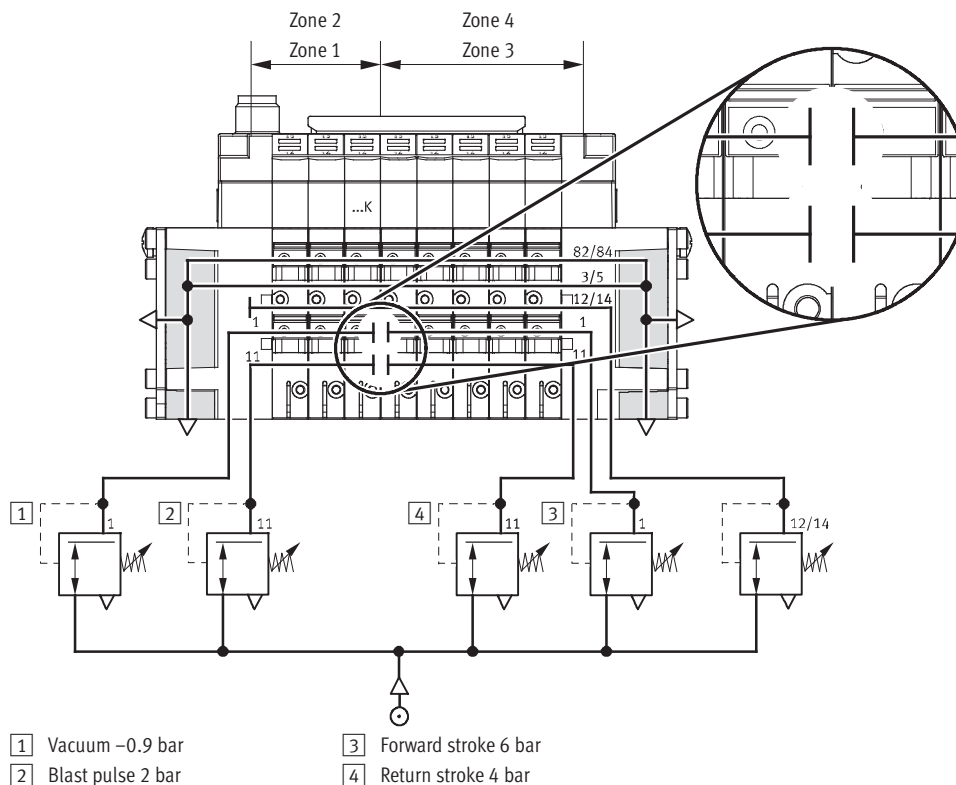

# Valve terminals type 10 CPV, Compact Performance, NPT

Key features – Pneumatic components



## Compressed air supply and exhausting

The two end plates that pressurise and exhaust the valve slices are a characteristic feature of a CPV valve terminal:

- Large duct cross sections ensure maximum flow rates even when multiple valves are switched in parallel

- Large flat plate silencers in the end plates
- Internal/external pilot air supply

Each individual valve is supplied with compressed air from two individual ducts (supply ports 1/11) and

exhausted via a large, integrated exhaust duct (exhaust 3/5). This design permits unique flexibility and functionality. It is the easiest way of realising a number of pressure zones per terminal or combinations of vacuum

applications.

The valve terminal is supplied via end plates, either on the left, on the right or on both sides. End plate combinations other than those listed are possible (on request).

## Pilot air supply

### Internal pilot air supply

Internal pilot air supply can be selected if the supply pressure at pneumatic port 1 is 3 ... 8 bar. With internal pilot air supply the branch is located in the left or right-hand end plate. There is no port 12/14.

### External pilot air supply

External pilot air supply is required if the supply pressure at pneumatic port 1 is less than 3 bar or greater than 8 bar. In this case, pressure of 3 ... 8 bar is applied at port 12/14. If a gradual pressure build-up in the

system using a pressurised on-off valve is required, external pilot supply air should be selected. The control pressure applied during switch-on is already very high in this case. External pilot air supply is also

required if it is necessary to ensure that the back pressure flaps (valve order code CY) are closed securely in the event of a sudden drop in operating pressure or if the operating pressure is switched off.

## End plates

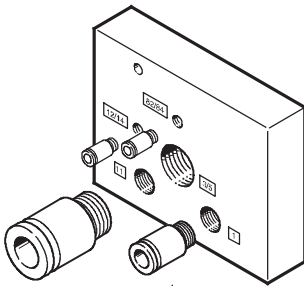

Example of an end plate: The diagram shows a left-hand end plate with external pilot air supply. The exhaust ports 3/5 and 82/84 can

be equipped with fittings or silencers. An end plate for internal pilot air supply does not have ports 12/14 and 11.

The port 82/84 is always present and should be fitted with a silencer. The port 12/14 is connected internally with port 1 on an end plate for internal pilot air supply.



# Valve terminals type 10 CPV, Compact Performance, NPT

Key features – Pneumatic components

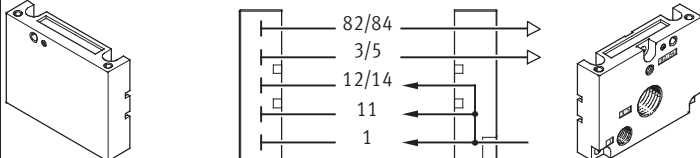
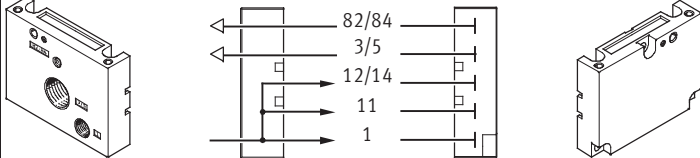
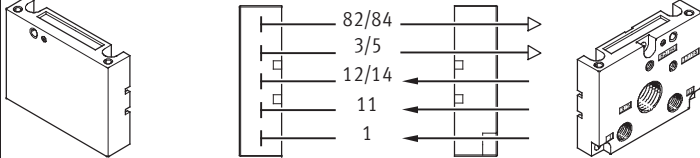
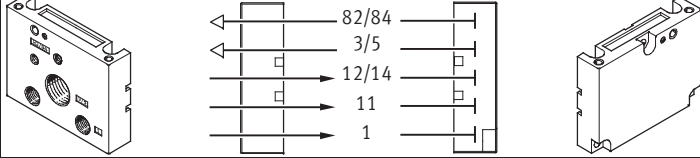
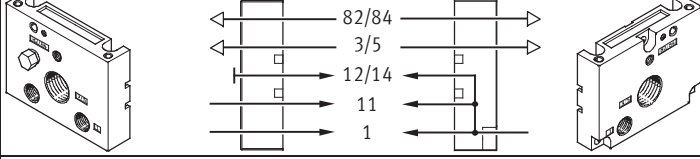
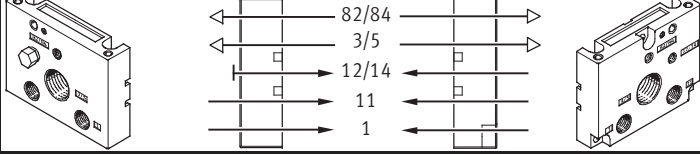
End plate combination for compressed air supply via end plate					
Code	Graphical symbol Type of pilot air supply (internal/external)	Size			Note
		10	14	18	
U	Internal pilot air supply 	■	■	■	<ul style="list-style-type: none"> <li>• Ports in right-hand end plate only</li> <li>• No pressure zone separation permissible</li> <li>• Not suitable for vacuum</li> </ul>
V	Internal pilot air supply 	■	■	■	<ul style="list-style-type: none"> <li>• Ports in left-hand end plate only</li> <li>• No pressure zone separation permissible</li> <li>• Not suitable for vacuum</li> </ul>
W	External pilot air supply 	■	■	■	<ul style="list-style-type: none"> <li>• Ports in right-hand end plate only</li> <li>• No pressure zone separation permissible</li> <li>• Suitable for vacuum</li> </ul>
X	External pilot air supply 	■	■	■	<ul style="list-style-type: none"> <li>• Ports in left-hand end plate only</li> <li>• No pressure zone separation permissible</li> <li>• Suitable for vacuum</li> </ul>
Y	Internal pilot air supply 	■	■	■	<ul style="list-style-type: none"> <li>• Ports in left-hand and right-hand end plate</li> <li>• Maximum three pressure zones</li> <li>• Valves to the left of the separator plate suitable for vacuum</li> </ul>
Z	External pilot air supply 	■	■	■	<ul style="list-style-type: none"> <li>• Ports in left-hand and right-hand end plate</li> <li>• Maximum four pressure zones</li> <li>• Suitable for vacuum</li> </ul>

# Valve terminals type 10 CPV, Compact Performance, NPT

Key features – Pneumatic components

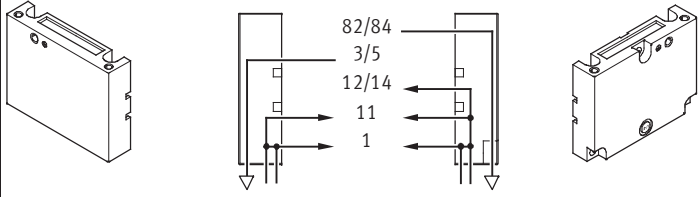
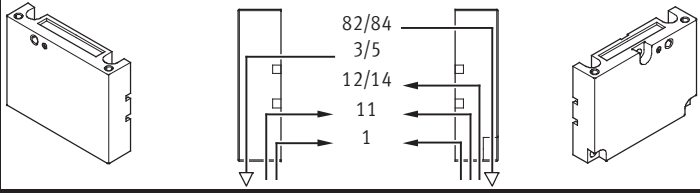
End plate combination for compressed air supply via pneumatic multiple connector plate					
Code	Graphical symbol Type of pilot air supply (internal/external)	Size			Note
		10	14	18	
Y	Internal pilot air supply 	■	■	■	<ul style="list-style-type: none"> <li>Ports on pneumatic multiple connector plate</li> <li>Pressure zone separation only permissible with separator plate (code T)</li> <li>Maximum two pressure zones</li> <li>Valves to the left of the separator plate suitable for vacuum</li> <li>Only for accessories M, P, V, GQC, GQD (pneumatic multiple connector plate)</li> </ul>
Z	External pilot air supply 	■	■	■	<ul style="list-style-type: none"> <li>Ports on pneumatic multiple connector plate</li> <li>Pressure zone separation only permissible with separator plate (code T)</li> <li>Maximum three pressure zones</li> <li>Suitable for vacuum</li> <li>Only for accessories M, P, V, GQC, GQD (pneumatic multiple connector plate)</li> </ul>

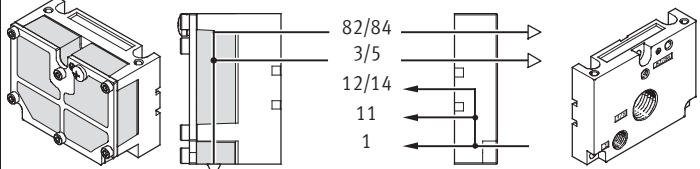
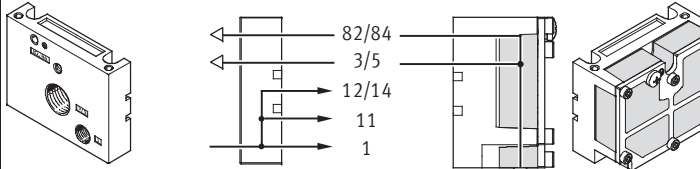
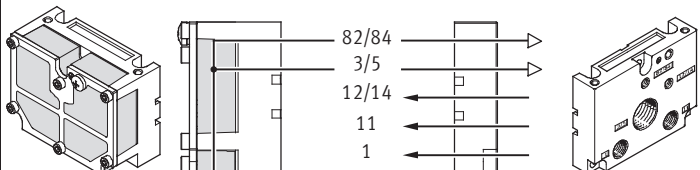
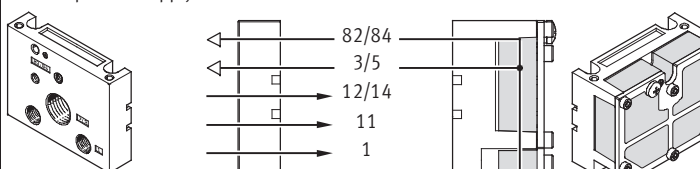
End plate combination for compressed air supply via end plates with flat plate silencer					
Code	Graphical symbol Type of pilot air supply (internal/external)	Size			Note
		10	14	18	
A	Internal pilot air supply 	■	■	■	<ul style="list-style-type: none"> <li>Ports in right-hand end plate</li> <li>No pressure zone separation permissible</li> <li>Not suitable for vacuum</li> </ul>
B	Internal pilot air supply 	■	■	■	<ul style="list-style-type: none"> <li>Ports in left-hand end plate</li> <li>No pressure zone separation permissible</li> <li>Not suitable for vacuum</li> </ul>
C	External pilot air supply 	■	■	■	<ul style="list-style-type: none"> <li>Ports in right-hand end plate</li> <li>No pressure zone separation permissible</li> <li>Suitable for vacuum</li> </ul>
D	External pilot air supply 	■	■	■	<ul style="list-style-type: none"> <li>Ports in left-hand end plate</li> <li>No pressure zone separation permissible</li> <li>Suitable for vacuum</li> </ul>

# Valve terminals type 10 CPV, Compact Performance, NPT

Key features – Pneumatic components

End plate combination for compressed air supply via pneumatic multiple connector plate with flat plate silencer					
Code	Graphical symbol Type of pilot air supply (internal/external)	Size			Note
		10	14	18	
E	External pilot air supply 	■	■	■	<ul style="list-style-type: none"> <li>Ports on pneumatic multiple connector plate</li> <li>Exhaust air vented via flat plate silencer on the right</li> <li>Pressure zone separation only permissible with separator plate (code T)</li> <li>Maximum four pressure zones</li> <li>Suitable for vacuum</li> <li>Only for accessories M, P, V, GQC, GQD (pneumatic multiple connector plate)</li> </ul>
F	External pilot air supply 	■	■	■	<ul style="list-style-type: none"> <li>Ports on pneumatic multiple connector plate</li> <li>Exhaust air vented via flat plate silencer on the left</li> <li>Pressure zone separation only permissible with separator plate (code T)</li> <li>Maximum four pressure zones</li> <li>Suitable for vacuum</li> <li>Only for accessories M, P, V, GQC, GQD (pneumatic multiple connector plate)</li> </ul>
G	Internal pilot air supply 	■	■	■	<ul style="list-style-type: none"> <li>Ports on pneumatic multiple connector plate</li> <li>Exhaust air vented via flat plate silencer on the left</li> <li>Pressure zone separation only permissible with separator plate (code T)</li> <li>Maximum three pressure zones</li> <li>Not suitable for vacuum</li> <li>Only for accessories M, P, V, GQC, GQD (pneumatic multiple connector plate)</li> </ul>
H	External pilot air supply 	■	■	■	<ul style="list-style-type: none"> <li>Ports on pneumatic multiple connector plate</li> <li>Exhaust air vented via flat plate silencers at both ends</li> <li>Pressure zone separation permissible</li> <li>Suitable for vacuum</li> <li>Only for accessories M, P, V, GQC, GQD (pneumatic multiple connector plate)</li> </ul>
J	Internal pilot air supply 	■	■	■	<ul style="list-style-type: none"> <li>Ports on pneumatic multiple connector plate</li> <li>Exhaust air vented via flat plate silencers at both ends</li> <li>Pressure zone separation permissible</li> <li>Maximum three pressure zones</li> <li>Valves to the left of the separator plate suitable for vacuum</li> <li>Only for accessories M, P, V, GQC, GQD (pneumatic multiple connector plate)</li> </ul>
K	Internal pilot air supply 	■	■	■	<ul style="list-style-type: none"> <li>Ports on pneumatic multiple connector plate</li> <li>Exhaust air vented via flat plate silencer on the right</li> <li>Pressure zone separation permissible</li> <li>Maximum three pressure zones</li> <li>Suitable for vacuum in combination with separator plate</li> <li>Only for accessories M, P, V, GQC, GQD (pneumatic multiple connector plate)</li> </ul>

# Valve terminals type 10 CPV, Compact Performance, NPT

Key features – Pneumatic components

## Pneumatic connection

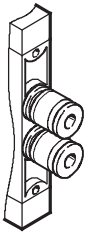

The working lines are located directly in the valve slices. Threaded connectors and Quick Star push-in fittings (QS) are available for different tubing sizes. The supply ports are located in the end plates or in the

pneumatic multiple connector plate. Push-in fittings are available fully assembled.

The following working lines can be selected:

- Threaded connectors: code C

- Large push-in connectors: code D
  - Small push-in connectors: code E
- Connection sizes for the threaded and QS push-in fittings can be found in the table below.

## Pneumatic multiple connector plate

One-piece “connection plates” that contain both working lines and supply ports can be combined with a pneumatic multiple connector plate. This enables the valve terminal as a pneumatic “function” to be separated from

the valve ports.

The pneumatic multiple connector plate enables different mounting options from wall mounting to direct passage through a cabinet wall.

Easy-to-service and flexible connection technology thanks to the following:

- Common connection via the pneumatic multiple connector plate with all connections on one side

- The valve terminal can be assembled/disassembled using only four screws, whereby the pneumatics remain fully connected
- Quick assembly/disassembly
- No errors when recommissioning as a result of incorrect connection of tubing

## CPV valve terminal

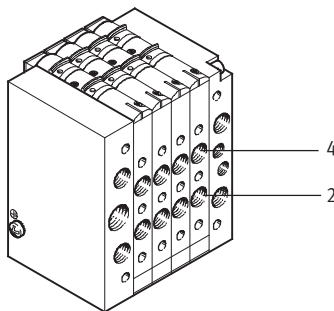

## Pneumatic multiple connector plate

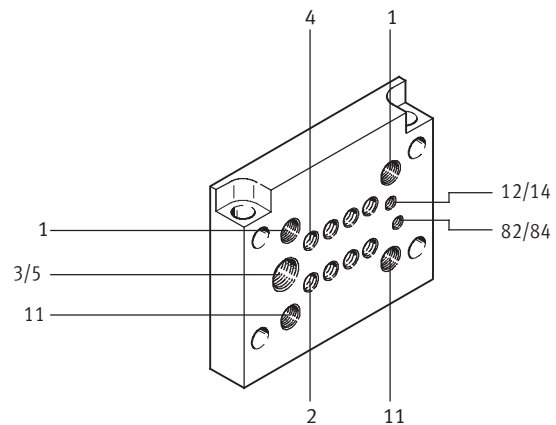

Connection sizes				
Connection to ISO 5599	CPV10	CPV14	CPV18	Comment
1/11 Working air	G $\frac{1}{8}$	G $\frac{1}{4}$	G $\frac{3}{8}$	Fitting in end plate or pneumatic multiple connector plate
2/4 Working line	M7	G $\frac{1}{8}$	G $\frac{1}{4}$	Connection in valve slice, connection for push-in fitting in brackets
3/5 Exhaust air port	G $\frac{3}{8}$	G $\frac{1}{2}$	G $\frac{1}{2}$	Via right-hand/left-hand end plate
	G $\frac{1}{4}$	G $\frac{3}{8}$	G $\frac{1}{2}$	Pneumatic multiple connector plate
12/14 Pilot air supply port	M5	G $\frac{1}{8}$	G $\frac{1}{4}$	Fitting in end plate or pneumatic multiple connector plate
82/84 Pilot exhaust air port	M5	G $\frac{1}{8}$	G $\frac{1}{4}$	Via right-hand/left-hand end plate
	M7 (M5) <sup>1)</sup>	G $\frac{1}{8}$	G $\frac{1}{4}$	Pneumatic multiple connector plate

1) With flanged pneumatic multiple connector plate

# Valve terminals type 10 CPV, Compact Performance, NPT

FESTO

Key features – Pneumatic components

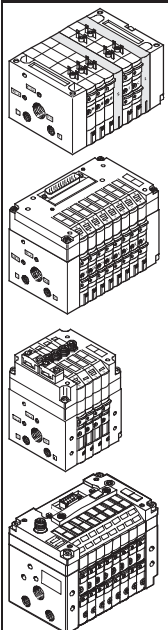
Pneumatic connection: fitting set for compressed air supply							
	Code for compressed air supply	Port	Designation	Size 10 Type	Size 14 Type	Size 18 Type	
	Without pneumatic multiple connector plate						
	U, V	82/84	Silencer	U-M5	U-1/8-B	U-1/4-B	
		3/5	Silencer	U-3/8-B	U-1/2-B	U-1/2-B	
		1	Push-in fitting	QS-1/8-5/16-I-U-M	QS-1/4-3/8-I-U-M	QS-3/8-3/8-I	
	W, X	82/84	Silencer	U-M5	U-1/8-B	U-1/4-B	
		3/5	Silencer	U-3/8-B	U-1/2-B	U-1/2-B	
		1	Push-in fitting	QS-1/8-5/16-I-U-M	QS-1/4-3/8-I-U-M	QS-3/8-3/8-I	
		12/14	Push-in fitting	QSM-M5-1/4-I-U-M	QS-1/8-5/16-I-U-M	QS-1/4-3/8-I-U-M	
	Y	82/84 on right	Silencer	U-M5	U-1/8-B	U-1/4-B	
		82/84 on left	Blanking plug	B-M5	B-1/8	B-1/4	
		3/5 on right	Silencer	U-3/8-B	U-1/2-B	U-1/2-B	
		3/5 on left	Blanking plug	B-3/8	B-1/2	B-1/2	
		1/11 on left	Push-in fitting	QS-1/8-5/16-I-U-M	QS-1/4-3/8-I-U-M	QS-3/8-3/8-I	
	Z	82/84 on right	Silencer	U-M5	U-1/8-B	U-1/4-B	
		82/84 on left	Blanking plug	B-M5	B-1/8	B-1/4	
		3/5 on right	Silencer	U-3/8-B	U-1/2-B	U-1/2-B	
		3/5 on left	Blanking plug	B-3/8	B-1/2	B-1/2	
		12/14 on right	Push-in fitting	QSM-M5-1/4-I-U-M	QS-1/8-5/16-I-U-M	QS-1/4-3/8-I-U-M	
		12/14 on left	Blanking plug	B-M5	B-1/8	B-1/4	
		1/11	Push-in fitting	QS-1/8-5/16-I-U-M	QS-1/4-3/8-I-U-M	QS-3/8-3/8-I	
	With pneumatic multiple connector plate; code M						
	Y	82/84	Silencer	UC-M7	U-1/8-B	U-1/4-B	
		12/14	Blanking plug	B-M7	B-1/8	B-1/4	
		3/5	Silencer	U-1/4-B	U-3/8-B	U-1/2-B	
		1/11 on left	Push-in fitting	QS-1/8-5/16-I-U-M	QS-1/4-3/8-I-U-M	QS-3/8-3/8-I	
		11 on right	Blanking plug	B-1/8	B-1/4	B-3/8	
	Z	82/84	Silencer	UC-M7	U-1/8-B	U-1/4-B	
		3/5	Silencer	U-1/4-B	U-3/8-B	U-1/2-B	
		12/14	Push-in fitting	QSM-M7-1/4-I-U-M	QS-1/8-5/16-I-U-M	QS-1/4-3/8-I-U-M	
		1/11 on left	Push-in fitting	QS-1/8-5/16-I-U-M	QS-1/4-3/8-I-U-M	QS-3/8-3/8-I	
With pneumatic multiple connector plate; code P, GQC							
Y	82/84	Silencer	U-M5	U-1/8-B	U-1/4-B		
	12/14	Blanking plug	B-M5	B-1/8	B-1/4		
	3/5	Silencer	U-1/4-B	U-3/8-B	U-1/2-B		
	1/11 on left	Push-in fitting	QS-1/8-8-I	QS-1/4-3/8-I-U-M	QS-3/8-12-I		
	11 on right	Blanking plug	B-1/8	B-1/4	B-3/8		
Z	82/84	Silencer	U-M5	U-1/8-B	U-1/4-B		
	3/5	Silencer	U-1/4-B	U-3/8-B	U-1/2-B		
	12/14	Push-in fitting	QSM-M5-1/4-I-U-M	QS-1/8-5/16-I-U-M	QS-1/4-3/8-I-U-M		
	1/11 on left	Push-in fitting	QS-1/8-5/16-I-U-M	QS-1/4-3/8-I-U-M	QS-3/8-3/8-I		

# Valve terminals type 10 CPV, Compact Performance, NPT

FESTO

Key features – Pneumatic components

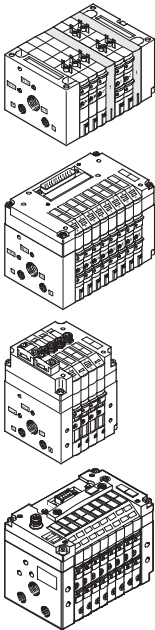
Pneumatic connection: fitting set for compressed air supply							
	Code for compressed air supply	Port	Designation	Size 10 Type	Size 14 Type	Size 18 Type	
	Without pneumatic multiple connector plate						
	A, B	82/84	Blanking plug	B-M5	B-1/8	B-1/4	
		3/5	Blanking plug	B-3/8	B-1/2	B-1/2	
		1	Push-in fitting	QS-1/8-5/16-I-U-M	QS-1/4-3/8-I-U-M	QS-3/8-3/8-I	
	C, D	82/84	Blanking plug	B-M5	B-1/8	B-1/4	
		3/5	Blanking plug	B-3/8	B-1/2	B-1/2	
		1	Push-in fitting	QS-1/8-5/16-I-U-M	QS-1/4-3/8-I-U-M	QS-3/8-3/8-I	
		12/14	Push-in fitting	QSM-M5-1/4-I-U-M	QS-1/8-5/16-I-U-M	QS-1/4-3/8-I-U-M	
	With pneumatic multiple connector plate; code M						
	E, F, H	82/84	Blanking plug	B-M7	B-1/8	B-1/4	
		3/5	Blanking plug	B-1/4	B-3/8	B-1/2	
		1/11	Push-in fitting	QS-1/8-5/16-I-U-M	QS-1/4-3/8-I-U-M	QS-3/8-3/8-I	
		12/14	Push-in fitting	QSM-M7-1/4-I-U-M	QS-1/8-5/16-I-U-M	QS-1/4-3/8-I-U-M	
	G, J, K	82/84	Blanking plug	B-M7	B-1/8	B-1/4	
		3/5	Blanking plug	B-1/4	B-3/8	B-1/2	
		On right in 1, left	Push-in fitting	QS-1/8-5/16-I-U-M	QS-1/4-3/8-I-U-M	QS-3/8-3/8-I	
		On right in 11	Blanking plug	B-1/8	B-1/4	B-3/8	
		12/14	Blanking plug	B-M7	B-1/8	B-1/4	
	With pneumatic multiple connector plate; code P, GQC						
	E, F, H	82/84	Blanking plug	B-M5	B-1/8	B-1/4	
		3/5	Blanking plug	B-1/4	B-3/8	B-1/2	
		1/11	Push-in fitting	QS-1/8-5/16-I-U-M	QS-1/4-3/8-I-U-M	QS-3/8-3/8-I	
		12/14	Push-in fitting	QSM-M5-1/4-I-U-M	QS-1/8-5/16-I-U-M	QS-1/4-3/8-I-U-M	
	G, J, K	82/84	Blanking plug	B-M5	B-1/8	B-1/4	
3/5		Blanking plug	B-1/4	B-3/8	B-1/2		
On right in 1, left		Push-in fitting	QS-1/8-5/16-I-U-M	QS-1/4-3/8-I-U-M	QS-3/8-3/8-I		
On right in 11		Blanking plug	B-1/8	B-1/4	B-3/8		
12/14		Blanking plug	B-M5	B-1/8	B-1/4		

# Valve terminals type 10 CPV, Compact Performance, NPT

Key features – Pneumatic components

## CPV valve terminal size 10 and 14 with valve extensions

### Function blocks

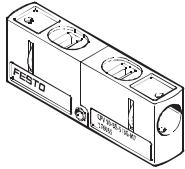

CPV10-BS-5/3G-M7  
CPV14-BS-5/3G-1/8

Valve kit 5/3G for creating a 5/3-way function, mid-position closed, for size 10 and 14:

The valve function “mid-position closed” is created using one valve slice with 2x 3/2-way valve, normally closed (valve function code C).

The valve kit CPV10-BS-5/3G-M7 or CPV14-BS-5/3G-1/8 (incorporating

a double piloted non-return valve function) is used for this.

This valve kit is intended for applications with one working pressure level per valve slice, i.e. it must not be used in dual-pressure applications (where the pressure levels at port 1 and 11 are different).

### Additional functions for valve positions

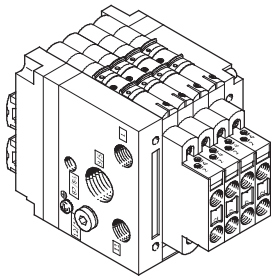

These valve extensions (vertical stacking) can be used to add further pneumatic functions to CPV valve terminals size 10 and 14:

- Two one-way flow control valves for flow regulation directly at the valve terminal for
  - supply air flow control
  - exhaust air flow control
- The vacuum flow control module must be used with the vacuum generator with or without ejector pulse and provides a non-return function and adjustable ejector pulse

**Note**  
The additional functions cannot be used in the first or last valve position in combination with the pneumatic multiple connector plate M, P and cannot be used in combination with the pneumatic multiple connector plate GQC, GQD.

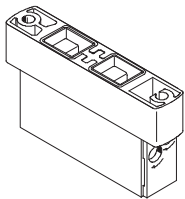

CPV10-BS-2xGRZZ-M7  
CPV14-BS-2xGRZZ-1/8

- 2x one-way flow control valve for supply air flow control
- Additional function code P

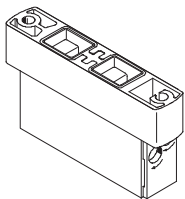

CPV10-BS-2xGRAZ-M7  
CPV14-BS-2xGRAZ-1/8

- 2x one-way flow control valve for exhaust air flow control
- Additional function code Q

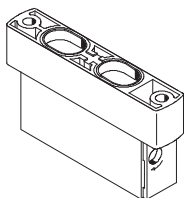

CPV10-BS-GRZ-V-M7  
CPV14-BS-GRZ-V-1/8

- Vacuum flow control module
- Additional function code V

# Valve terminals type 10 CPV, Compact Performance, NPT

Key features – Assembly

## Mounting options

The valve terminals have holes for four mounting screws. The mounting side is the side with the pneumatic fittings. These holes are also used to mount the valve terminal on a pneumatic multiple connector plate.

There are other mounting options in addition to this method:

- H-rail mounting
- Wall mounting
- Wall mounting via flanged pneumatic multiple connector plate

- On rear side via wall mounting
- On front side (CPV10/14 with IC connection only)
- Mounting via through-hole in wall

The attachments are mounted with a screw and fixing bolt on the left-hand and right-hand end plates.

## Attachment for H-rail

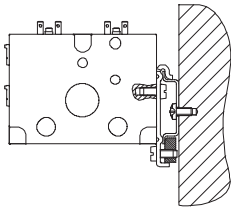

For valve terminal CPV10/14:  
CPV10/14-VI-BG-NRH-35  
(mounting code H)

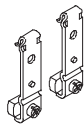

For valve terminal CPV18:  
CPV18-VI-BG-NRH-35  
(mounting code H)



H-rail to EN 60715, not for accessories M, P, V (pneumatic multiple connector plate)

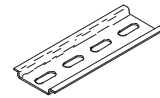

## Attachment for wall mounting

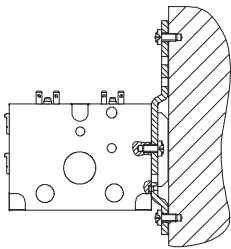

For valve terminal CPV10/14:  
CPV10/14-VI-BG-RWL-B  
(mounting code U)



For valve terminal CPV18:  
CPV18-VI-BG-RW  
(mounting code W)

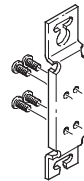

## Attachment for individual connection and ET200X/ET200pro (included in the scope of delivery)

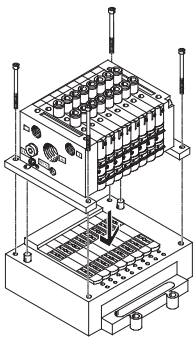

For valve terminal CPV10/14:  
CPV...-VI-BG-ET200X  
(mounting code X)

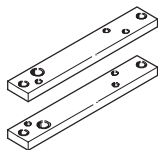

## Through-hole in wall, for example on the machine

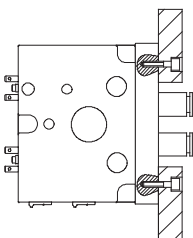

## Wall mounting via pneumatic multiple connector plate

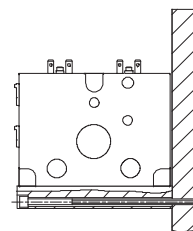



# Valve terminals type 10 CPV, Compact Performance, NPT

Key features – Assembly

## Pneumatic multiple connector plate for wall/machine mounting

With flange, code P

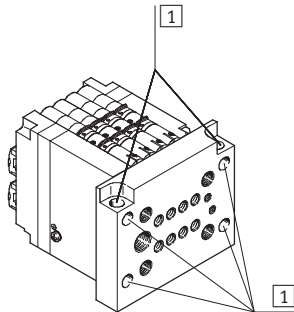

1 Mounting holes

- Multiple connector plate projects past the end plates
- Through mounting holes (without thread) in the flange
- Two additional holes running laterally through the pneumatic multiple connector plate also enable rear mounting of the CPV valve terminal

Without flange, code M

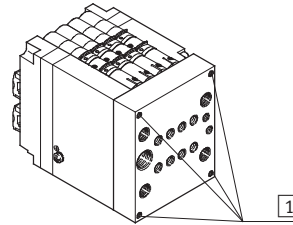

1 Mounting holes

- Multiple connector plate fits flush with the end plates
- Mounting holes (with thread) for wall or foot mounting are on the connection side of the pneumatic multiple connector plate

## Pneumatic multiple connector plate for control cabinet assembly

With supply ports, code GQC

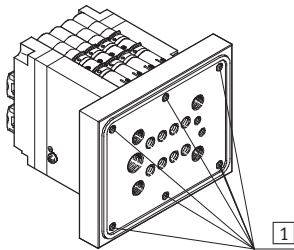

1 Mounting holes

- For 10 mm and 14 mm
- Multiple connector plate projects past the end plates
- Mounting holes (with thread) in the flange
- Multiple connector plate with seal

Without supply ports, code GQD

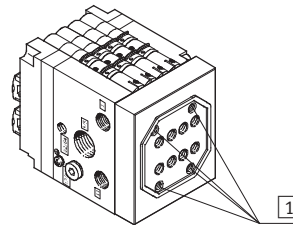

1 Mounting holes

- For 10 mm and 14 mm
- Multiple connector plate fits flush with the end plates
- The mounting holes (with thread) are on the connection side of the pneumatic multiple connector plate
- Multiple connector plate with seal

With supply ports, code GQE

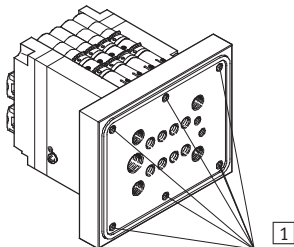

1 Mounting holes

- For 10 mm
- Multiple connector plate projects past the end plates
- Mounting holes (with thread) in the flange
- Multiple connector plate with seal

-  - Note

The outer valve slices cannot be equipped with valve extensions (e.g. one-way flow control valve) when using the pneumatic multiple connector plate M or P.

CPV valve terminals with flat plate silencers are only suitable for wall mounting.

If the pneumatic multiple connector plate GQC, GQD or GQE is used, the following limitations apply:

- Generally no attachment of valve extensions
- Not in combination with H-rail mounting
- Not in combination with wall mounting
- Only with 10 mm and 14 mm

# Valve terminals type 10 CPV, Compact Performance, NPT

Key features – Display and operation

## Manual override

Three types of manual override are available:

- Non-detenting via slide
- Detenting
- Blocked

Subsequent conversion of the manual override from non-detenting to detenting or blocked is possible at any time.

The locking clip on the valve must be removed to this end. This is only possible after the individual valve has been removed or the tie rod of the valve terminal has been released.

 - Note  
See the manual for instructions.

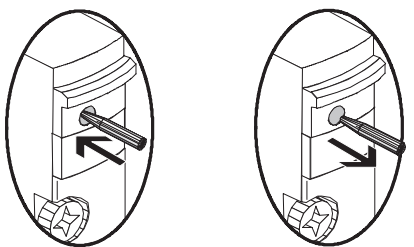
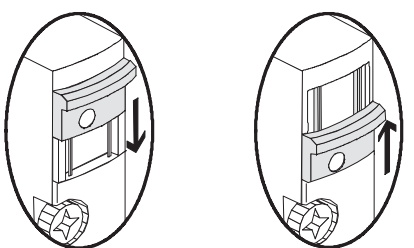
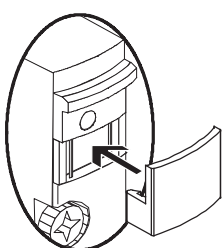
Code	Graphical symbol	Size			Note
		10	14	18	
N	<p>Manual override, non-detenting</p> 	■	■	■	<p>In the “non-detenting” version, the blue slide is held via a locking clip. A pointed object (e.g. pen, etc.) can be used to activate the manual override through the opening.</p>
R	<p>Manual override, detenting</p> 	■	■	■	<p>In the “detenting” version, the locking clip is removed and the manual override is activated by pushing the slide down. The non-detenting function can be re-established by re-installing the locking clip.</p>
V	<p>Manual override, blocked</p> 	■	■	■	<p>In the “blocked” version, non-detenting and detenting activation of the manual override is prevented by means of a cover. Like the non-detenting locking clip, this cover can be added subsequently, but then remains on the valve.</p>

# Valve terminals type 10 CPV, Compact Performance, NPT

Key features – Display and operation

## Display and operation

You will find the following LEDs for displaying the switching status on the electrical connections of the CPV valve terminal:

- Display of the switching status of the pilot solenoid coil 12 for outlet port 2
- Display of the switching status of the pilot solenoid coil 14 for outlet port 4

- Readable from the “top” as well as from the “front”

The individual connection has an LED in the connector plug to display the switching status.

Inscription labels

- Clip with inscription field on cable socket (with individual connection)
- Inscription clips on connection node (multi-pin plug, AS-interface, CP installation system, Fieldbus Direct)

### CPV valve terminal with individual connection

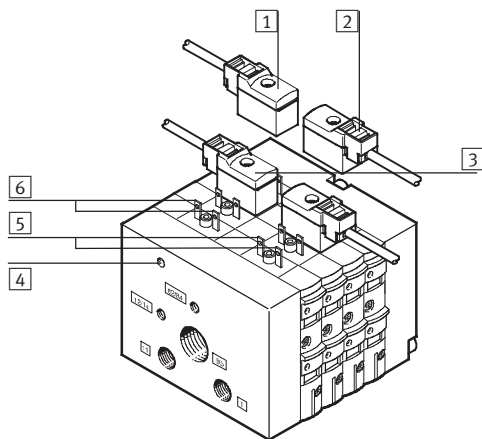

- 1 Pre-assembled plug socket for each pilot solenoid coil
- 2 Slot for inscription label (for each plug socket)
- 3 Yellow LED, signal status display for pilot solenoid coils (for each plug socket)
- 4 Earth terminal

### CPV valve terminal with multi-pin plug connection

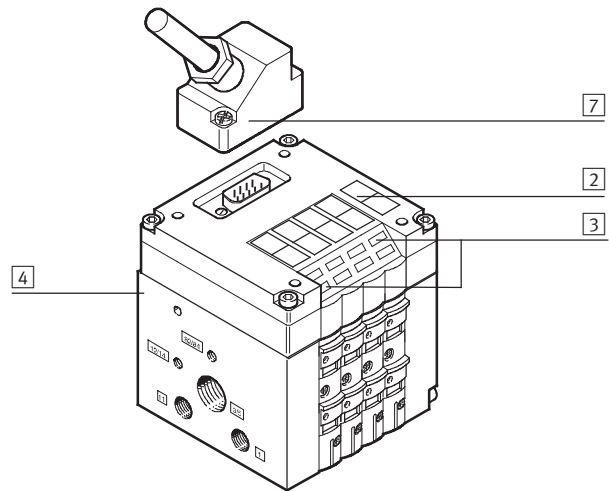

- 5 Terminal lugs for solenoid coil 14
- 6 Terminal lugs for solenoid coil 12
- 7 Sub-D multi-pin plug (9-pin for valve terminals with 4 valves, 25-pin for valve terminals with 6 or 8 valves)

# Valve terminals type 10 CPV, Compact Performance, NPT

Key features – Display and operation

## Identification system

Inscription labels can be affixed as follows:

- On the top of the electrical base unit
- On the inscription label holder

The inscription label holder permits the addition of inscription labels, protects the manual overrides and prevents them from being accidentally activated. The inscription labels are used to record additional information regarding the valves.

The inscription label holders can be ordered together with the valve terminal using the order code. The relevant inscription labels are supplied in a frame and are ordered separately.



### Transparent inscription label holder

The transparent inscription label holder CPV...-VI-ST-... offers a further labelling option, for example for large paper labels that can be read from both sides.

The inscription label holder cannot be used together with the relay plate.

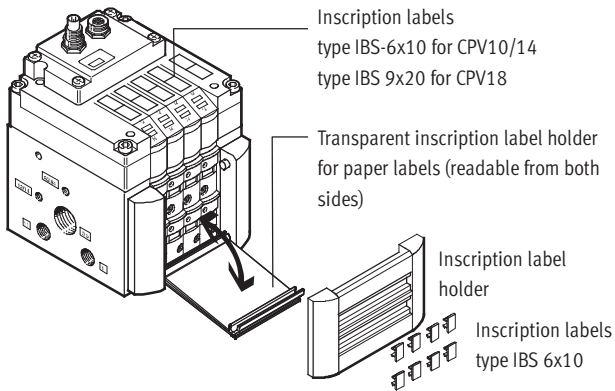
**Note**  
The Word templates for CPV label holders can be found at:  
[www.festo.com](http://www.festo.com)

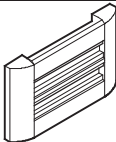
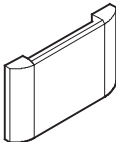

Ordering data				
	Code	Designation	Part No.	Type
<b>Inscription label holder</b>				
	Z	Holder for inscription labels	Dependent on the number of valve positions → 64	CPV...-VI-BZ-T...
	T	Holder for inscription labels, transparent		CPV...-VI-ST-T...
<b>Inscription labels</b>				
	-	6x10 mm, 64 pieces in frames	18576	IBS-6x10
	-	9x20 mm, 20 pieces in frames	18182	IBS-9x20

# Valve terminals type 10 CPV, Compact Performance, NPT

Key features – Electrical components

## Electrical connection

Contacts that are fitted on the top of the valve slices form the interface for various electrical connection options. The electrical connection is attached from above using four screws. This

means that the valve terminal can be adapted to different electrical requirements or fieldbus protocols using the same pneumatic part.

## Electrical power

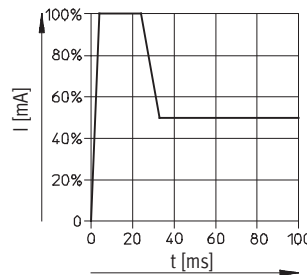

CPV10/14 valves are actuated by means of an integrated current reduction circuit, which reduces power consumption and heat build-up. This current reduction circuit is integrated in the electrical base unit (multi-pin plug or fieldbus connection) or in the individual connecting cable.

During switch-off, the voltage peaks are limited to 38 V DC.

## Individual connection

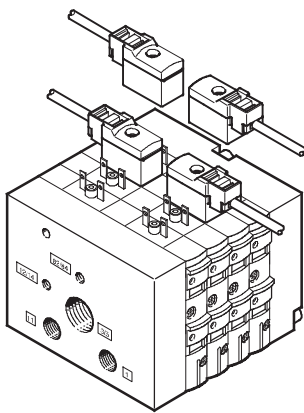

With an individual connection integration is only carried out in the pneumatic part, the solenoid valves are connected with individual cables.

Ordering data					
	Code	Designation		Part No.	Type
Plug socket with cable for individual connection, electrical, for CPV10/14					
	D	Plug socket with cable	2.5 m	193683	KMYZ-7-24-2,5-LED-PUR
	E	Plug socket with cable	5 m	193685	KMYZ-7-24-5-LED-PUR
	F	Plug socket with cable	10 m	196070	KMYZ-7-24-10-LED-PUR
Plug socket with cable for individual connection, electrical, for CPV18					
	D	Plug socket with cable	2.5 m	174844	KMEB-2-24-2,5-LED
	E		5 m	174845	KMEB-2-24-5-LED

Note  
Connecting cables are pre-assembled. They include a protective circuit and an LED indicating the operating status.

# Valve terminals type 10 CPV, Compact Performance, NPT

Key features – Electrical components

## Dimensions – Connecting cable for individual connection

Download CAD data → [www.festo.com](http://www.festo.com)

KMYZ-7-24-...

Technical drawings of the KMYZ-7-24-... valve terminal. The top view shows a diameter of  $\phi 7.4$  and a length of 9.7. The side view shows a cable length of 28.1, a cable diameter of  $\phi 3$ , and a mounting screw length of 17.5. The bottom view shows a cable diameter of 11.25 and a mounting screw length of 13.25. Callouts 1-5 indicate: 1 LED illuminated area, 2 Designation area, 3 2-wire cable 2.5 m, 5 m or 10 m (2x 0.25 mm<sup>2</sup>), 4 Connection pattern for MZC, and 5 Type of mounting: self-tapping screw, captive, max. tightening torque 0.25 Nm.

- 1 LED illuminated area
- 2 Designation area
- 3 2-wire cable 2.5 m, 5 m or 10 m (2x 0.25 mm<sup>2</sup>)
- 4 Connection pattern for MZC
- 5 Type of mounting: self-tapping screw, captive, max. tightening torque 0.25 Nm

KMEB-2-24-...-LED

Technical drawings of the KMEB-2-24-...-LED valve terminal. The top view shows a diameter of  $\phi 7$  and a length of 16. The side view shows a cable length of 22, a cable diameter of  $\phi 3$ , and a mounting screw length of 17.5. The bottom view shows a cable length of 35, a cable diameter of  $\phi 3$ , and a mounting screw length of 17.5. Callouts 1-4 indicate: 1 LED illuminated area, 2 Inscription label IBS-9x20 Part No. 18 182, 3 3-wire cable 2.5 or 5 m (3x 0.75 mm<sup>2</sup>), and 4 Connection pattern to DIN 43650, type C.

- 1 LED illuminated area
- 2 Inscription label IBS-9x20 Part No. 18 182
- 3 3-wire cable 2.5 or 5 m (3x 0.75 mm<sup>2</sup>)
- 4 Connection pattern to DIN 43650, type C

## Dimensions – Connecting cable for relay plate

Download CAD data → [www.festo.com](http://www.festo.com)

KRP-1-24-...

Technical drawings of the KRP-1-24-... valve terminal. The top view shows a diameter of  $\phi 3.5$  and a length of 9.8. The side view shows a cable length of 28.3, a cable diameter of  $\phi 3$ , a mounting screw length of 18, and a mounting screw diameter of  $\phi 1.8$ . The bottom view shows a cable length of 18, a cable diameter of  $\phi 3$ , and a mounting screw length of 12. Callouts 1-3 indicate: 1 Cable 2x 0.25 mm<sup>2</sup>, 2 Location for inscription labels (order code IBS 6x10, Part No. 18 576), and 3 Mounting screw (self-tapping KB 1.8x9).

- 1 Cable 2x 0.25 mm<sup>2</sup>
- 2 Location for inscription labels (order code IBS 6x10, Part No. 18 576)
- 3 Mounting screw (self-tapping KB 1.8x9)

# Valve terminals type 10 CPV, Compact Performance, NPT

Key features – Electrical components



## Multi-pin plug connection

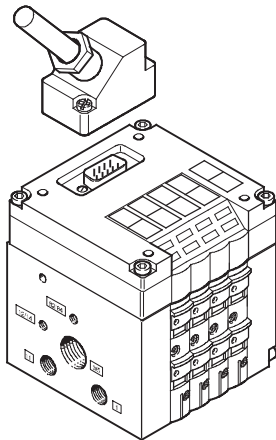

In addition to pneumatic integration, a multi-pin plug connection also provides integration of the electrical side and facilitates connection to the control cabinet and the valve terminal via a single cable.

Sub-D 9-pin and 25-pin plugs are used for connection. The plug housing of the KMP-...- cable provides the Sub-D connectors with IP65 protection.

The following sizes of plug connector are used:

- 4-valve valve terminal: 9-pin
- 6-valve valve terminal: 25-pin
- 8-valve valve terminal: 25-pin

The cable KMP6-... can alternatively be used for applications with IP40 protection.

Pre-assembled connecting cables are available for easy connection.

Standard lengths of 5 m and 10 m can be supplied. The pre-assembled connecting cables are also available in a design suitable for use with energy chains.

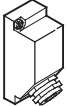
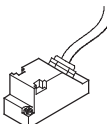
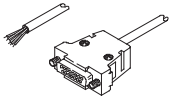
Ordering data							
	Code	Designation	Part No.	Type			
Multi-pin plug cable							
	Y	Plug socket (Sub-D plug can be crimped), for self-assembly	9-pin		<b>18708</b> SD-SUB-D-BU9		
			25-pin		<b>18709</b> SD-SUB-D-BU25		
	R	Connecting cable, IP65, polyvinyl chloride	9-pin	5 m	<b>18698</b> KMP3-9P-08-5		
			25-pin		<b>18624</b> KMP3-25P-16-5		
			S	9-pin	10 m	<b>18579</b> KMP3-9P-08-10	
				25-pin		<b>18625</b> KMP3-25P-16-10	
	-	Connecting cable, IP65, polyurethane (suitable for energy chains)	9-pin	5 m	<b>193014</b> KMP4-9P-5-PUR		
			25-pin		<b>193018</b> KMP4-25P-5-PUR		
			-	Connecting cable, IP65, polyvinyl chloride (suitable for energy chains)	9-pin	10 m	<b>193015</b> KMP4-9P-10-PUR
					25-pin		<b>193019</b> KMP4-25P-10-PUR
	-	Connecting cable, IP65, polyvinyl chloride (suitable for energy chains)	9-pin	5 m	<b>193012</b> KMP4-9P-5-PVC		
			25-pin		<b>193016</b> KMP4-25P-5-PVC		
-			Connecting cable, IP65, polyvinyl chloride (suitable for energy chains)	9-pin	10 m	<b>193013</b> KMP4-9P-10-PVC	
				25-pin		<b>193017</b> KMP4-25P-10-PVC	
	-	Connecting cable, IP40, polyvinyl chloride, only for CPV10/14	9-pin	2.5 m	<b>531184</b> KMP6-09P-8-2,5		
			25-pin		<b>530046</b> KMP6-25P-20-2,5		
			9-pin	5 m	<b>531185</b> KMP6-09P-8-5		
			25-pin		<b>530047</b> KMP6-25P-20-5		
			9-pin	10 m	<b>531186</b> KMP6-09P-8-10		
			25-pin		<b>530048</b> KMP6-25P-20-10		

# Valve terminals type 10 CPV, Compact Performance, NPT

Key features – Electrical components

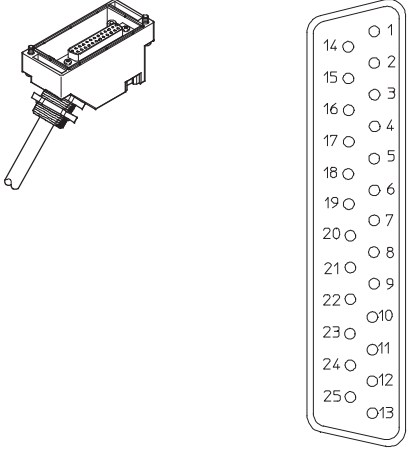
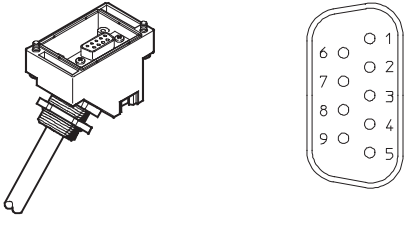
Pin allocation – Pre-assembled multi-pin cable (viewed from plug-in direction)				
Plug view	Pin	Wire colour	Valve 24 V DC	
Cable KMP3-25P-16... or KMP4-25P... with 25-pin Sub-D plug for 6-valve and 8-valve valve terminal				
	1	White	1	
	2	Green	12	
	3	Yellow	2	
	4	Grey	14	
	5	Pink	12	
	6	Blue	3	
	7	Red	14	
	8	Purple	12	
	9	Grey-pink	4	
	10	Red-blue	5	
	11	White-green	14	
	12	Brown-green	12	
	13	White-yellow	7	
	14	Yellow-brown	14	
	15	White-grey	12	
	16	Grey-brown	8	
	17	White-pink (KMP4 only)	14	
	18	Pink-brown (KMP4 only)	12	
	19	White-blue (KMP4 only)		
	20	Brown-blue (KMP4 only)		
	21	White-red (KMP4 only)		
	22	Brown-red (KMP4 only)		
	23	White-black (KMP4 only)		
	24	Brown	(0 V) <sup>1)</sup>	
	25	Black	(0 V) <sup>1)</sup>	
Cable KMP3-9P... or KMP4-9P... with 9-pin Sub-D plug for 4-valve valve terminal				
	1	White	1	
	2	Green	12	
	3	Yellow	2	
	4	Grey	14	
	5	Pink	12	
	6	Blue	3	
	7	Red	14	
	8	Purple	12	
	9	Black	Common	

1) 0 V for positive switching control signals; connect 24 V for negative switching control signals; mixed operation is not permitted.



# Valve terminals type 10 CPV, Compact Performance, NPT

Key features – Electrical components

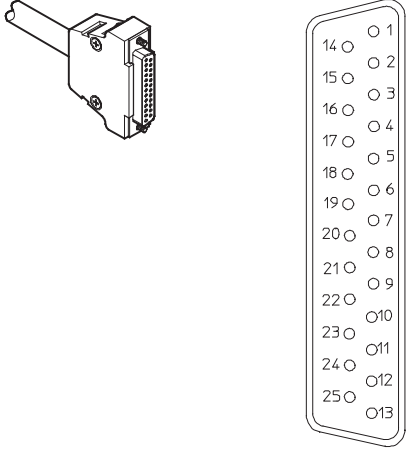
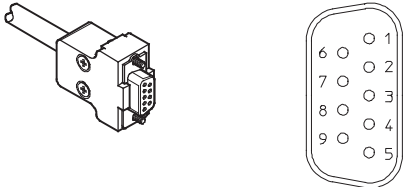
Pin allocation – Pre-assembled multi-pin cable (viewed from plug-in direction)			
Plug view	Pin	Wire colour	Valve 24 V DC
<b>Cable KMP6-25P-20... with 25-pin Sub-D plug for 6-valve and 8-valve valve terminals</b>			
	1	White	1
	2	Brown	12
	3	Green	2
	4	Yellow	14
	5	Grey	12
	6	Pink	3
	7	Blue	14
	8	Red	12
	9	Black	4
	10	Purple	5
	11	Grey-pink	14
	12	Red-blue	12
	13	White-green	6
	14	Brown-green	7
	15	White-yellow	14
	16	Yellow-brown	12
	17	White-grey	
	18	Grey-brown	
	19	White-pink	
	20	Pink-brown	
	21	White-blue <sup>1)</sup>	
	22	Brown-blue <sup>1)</sup>	
	23	White-red <sup>1)</sup>	
	24	Brown-red <sup>1)</sup>	(0 V) <sup>2)</sup>
	25	White-black <sup>1)</sup>	(0 V) <sup>2)</sup>
<b>Cable KMP6-9P-20... with 9-pin Sub-D plug for 4-valve valve terminals</b>			
	1	White	1
	2	Brown	12
	3	Green	2
	4	Yellow	14
	5	Grey	12
	6	Pink	3
	7	Blue	14
	8	Red	12
	9	Black	Common

1) Wire cross section 0.34 mm<sup>2</sup>

2) 0 V for positive switching control signals; connect 24 V for negative switching control signals; mixed operation is not permitted.

# Valve terminals type 10 CPV, Compact Performance, NPT

Key features – Electrical components



## Valve terminal type 10 – AS-interface valve terminal

The AS-interface facilitates wide ranging physical distribution of individual components or small component groups.

The AS-interface connection of valve terminal type 10 can be used to control 2, 4, 8 solenoid coils.

The valve terminal cover contains the LEDs that indicate the operating status and the protective circuit for the valves.

The AS-interface protocol standard permits a maximum of 4 inputs and 4 outputs in one unit. The use of 2 AS-interface slaves in one valve terminal means that 8 inputs and 8 outputs can be controlled in an 8-valve valve terminal (8 solenoid coils).

All CPV valve terminals can be operated using additional functions, e.g. relay plates or vacuum generators.

Valve terminals CPV with inputs are also available for A/B operation to SPEC 2.1 and 3.0.

### AS-interface control

- For 2, 4 or 8 valves
- Great variety thanks to the wide range of modules in the system

### AS-interface with A/B operation

- For 3 or 4 and/or 6 or 8 valves depending on the specification
- All the benefits of the simple installation system are retained

- 100% more inputs/master
- 50% more outputs/master
- Improved peripheral error diagnostics
- More AS-interface functions in Specifications 2.1 and 3.0

→ Internet: as-interface

## AS-interface valve terminal with auxiliary power supply

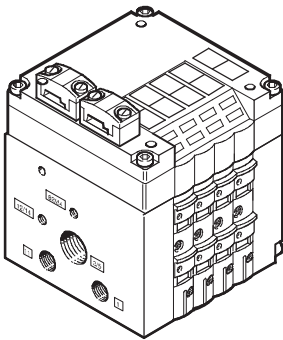

## AS-interface valve terminal with auxiliary power supply and inputs

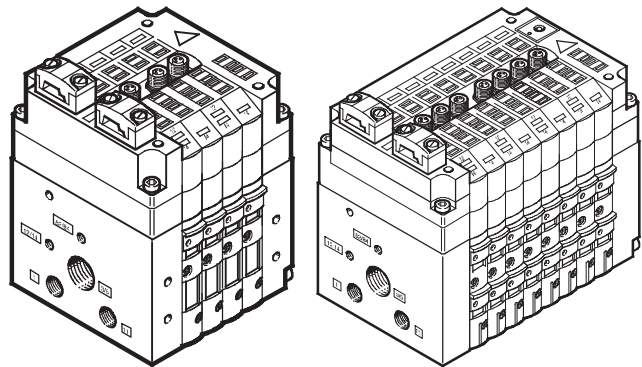

## CP/CPI installation system, valve terminal

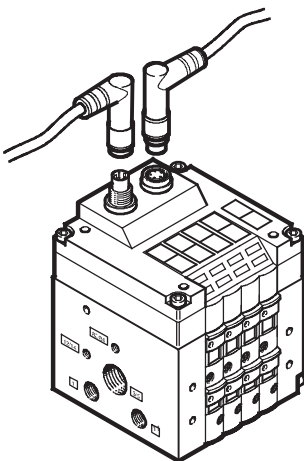

The integration of valve terminal type 10 into a fieldbus system or independent control system is accomplished by connecting the terminal to the corresponding fieldbus node or control block with simple, pre-assembled terminal connectors.

The installation system integrates the valve terminal CPV and various I/O modules, etc. into a single installation concept.

The 5-pin connecting cables carry the supply power and control signals. The valve terminal cover contains the LEDs that indicate the operating status and the protective circuits for the valves.

- Max. 8 valve slices for up to 16 CPV valves

The CP string is used to exchange the input and output states of the connected modules with the CP fieldbus node.

→ Internet: ctec

# Valve terminals type 10 CPV, Compact Performance, NPT

Key features – Electrical components

## Fieldbus Direct valve terminal

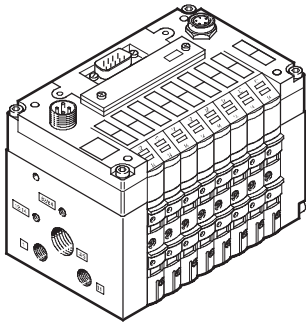

Fieldbus Direct is a system for connecting one valve terminal to nine different fieldbus standards. The most important systems, including Profibus, Interbus, DeviceNet and CANopen, are supported.

The CP string extension option enables the functions and

components of the CPI installation system to be used.

The optional string extension permits additional valve terminals and I/O modules with CP/CPI function to be connected to the Fieldbus Direct fieldbus node.

Depending on the version, the valve terminals are available in all three sizes, 10, 14 and 18 mm, each with 8 valve slices.

## ET200X/ET200pro pneumatic interface for CPV10 and CPV14

Adaptation of the CPV valve terminal to the input/output module ET200X/ET200pro from Siemens. The combination of the functional modules of the ET200X/ET200pro and the pneumatic functions of the CPV valve terminal provides a highly integratable automation solution for systems

using electrical and pneumatic drives with:

- 8 valve slices for up to 16 CPV valves
- Faster and more reliable contacting
- CPV 10 and CPV 14 valve terminals
- High IP65/IP67 protection
- Modular design

- Large number of I/O modules
  - digital I/O
  - analogue I/O
  - supply branching for activation of three-phase motors
- Profibus DP interface

Mounting kit for ET200X CPV-...-VI-BG-ET200X (included in the scope of delivery)

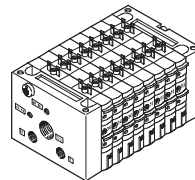
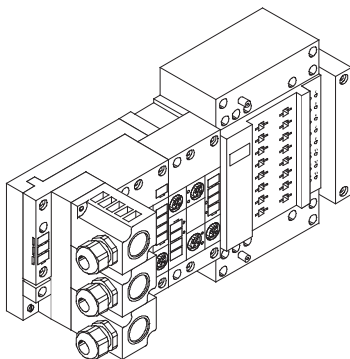
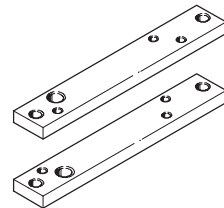

Specific data on the ET200X/ET200pro pneumatic interface can be found in Siemens product catalogues.

### - Note

A moulded seal is required for the valve terminal CPV10-ET200pro in order to achieve the IP protection class.

The moulded seal CPV10-...-GE-8 or CPV14-...-GE-8 must be ordered separately.

# Valve terminals type 10 CPV, Compact Performance, NPT

FESTO

Instructions for use

## Equipment

Operate system equipment with unlubricated compressed air if possible. Festo valves and cylinders are designed so that, if used as designated, they will not require additional lubrication and will still achieve a long service life. The quality of compressed air downstream of the compressor must correspond to that of unlubricated compressed air. If possible, do not operate all your system equipment with lubricated compressed air. The lubricators should, where possible, always be installed directly upstream of the actuator used.

Incorrect additional oil and too high an oil content in the compressed air reduce the service life of the valve terminal. Use Festo special oil OFSW-32 or the alternatives listed in the Festo catalogue (as specified in DIN 51524 HLP32; basic oil viscosity 32 CST at 40 °C).

### Bio-oils



When using bio-oils (oils based on synthetic or native ester, e.g. rapeseed oil methyl ester), the maximum residual oil content of 0.1 mg/m<sup>3</sup> must not be exceeded (see ISO 8573-1 Class 2).

### Mineral oils

When using mineral oils (e.g. HLP oils to DIN 51524, parts 1 to 3) or similar oils based on poly-alpha-olefins (PAO), the maximum residual oil content of 5 mg/m<sup>3</sup> must not be exceeded (see ISO 8573-1 Class 4). A higher residual oil content irrespective of the compressor oil cannot be permitted, as the basic lubricant would be flushed out over time.

# Valve terminals type 10 CPV, Compact Performance, NPT

Technical data

-  - Flow rate  
 CPV10: 400 l/min  
 CPV14: 800 l/min  
 CPV18: 1,600 l/min
  
-  - Valve width  
 CPV10: 10 mm  
 CPV14: 14 mm  
 CPV18: 18 mm
  
-  - Voltage  
 24 V DC



General technical data				
		CPV10	CPV14	CPV18
Design		Electromagnetically actuated piston spool valve		
Lubrication		Lubricated for life, PWIS-free (free of paint-wetting impairment substances)		
Type of mounting		Via pneumatic multiple connector plate		
		Via backwall		
		On H-rail		
Mounting position		Any		
Manual override		Non-detenting/detenting/blocked		
Width	[mm]	10	14	18
Nominal size	[mm]	4	6	8
Nominal flow rate without fitting	[l/min]	400	800	1,600
Pneumatic connections <sup>1)</sup>				
Pneumatic connection		Via end plate or pneumatic multiple connector plate		
Supply port	1/11	G $\frac{1}{8}$	G $\frac{1}{4}$	G $\frac{3}{8}$
Exhaust port	3/5	G $\frac{3}{8}$ (G $\frac{1}{4}$ )	G $\frac{1}{2}$ (G $\frac{3}{8}$ )	G $\frac{1}{2}$
Working lines	2/4	M7	G $\frac{1}{8}$	G $\frac{1}{4}$
Pilot air supply port	12/14	M5 (M7)	G $\frac{1}{4}$	G $\frac{1}{4}$
Pilot exhaust air port	82/84	M5 (M7)	G $\frac{1}{8}$	G $\frac{1}{4}$

1) Connection dimensions in brackets for pneumatic multiple connector plate

# Valve terminals type 10 CPV, Compact Performance, NPT

FESTO

Technical data

Operating and environmental conditions												
Valve function order code	M, MK	F	J, JK	N, NK	C, CK	CY	H, HK	G	D, DK	I, IK	A	E
Operating medium	Filtered compressed air, lubricated or unlubricated, inert gases → 36											
Grade of filtration	[µm]	40 (average pore size)										
Operating pressure	[bar]	-0.9 ... +10				+0.1 ... +10		-0.9 ... +10				
Operating pressure for valve terminal with internal pilot air supply	[bar]	3 ... 8										
Pilot pressure	[bar]	3 ... 8										
Ambient temperature	[°C]	-5 ... +50 (vacuum generators: 0 ... +50)										
Temperature of medium	[°C]	-5 ... +50 (vacuum generators: 0 ... +50)										
Storage temperature	[°C]	-20 ... +40										
Relative air humidity at 25 °C	[%]	95 with no condensation										
Corrosion resistance class CRC <sup>1)</sup>		2										1
Note on materials	RoHS-compliant											

1) Corrosion resistance class 1 according to Festo standard 940 070

Components subject to low corrosion stress. Transport and storage protection. Parts that do not have primarily decorative surface requirements, e.g. in internal areas that are not visible or behind covers.

Corrosion resistance class 2 according to Festo standard 940 070

Components subject to moderate corrosion stress. Externally visible parts with primarily decorative surface requirements which are in direct contact with a normal industrial environment or media such as coolants or lubricating agents.

Certifications	
This product is certified for use in the ATEX zone in accordance with the EU ATEX Directive	
ATEX category for gas	II 3G
Explosion ignition protection type for gas	Ex nA II T4 X
ATEX category for dust	II 3D
Explosion ignition protection type for dust	Ex tD A22 IP54 T110° C X
ATEX temperature rating	[°C] -5 ≤ Ta ≤ +50
Certification	cULus recognized (OL)
Ex certification to NEC 500	Class 1, Div. 2, Gr. A, B, C, D
CE mark (see declaration of conformity)	To EU Low Voltage Directive
	To EU Explosion Protection Directive (ATEX)

# Valve terminals type 10 CPV, Compact Performance, NPT

Technical data

Electrical data		CPV10	CPV14	CPV18
Operating voltage	[V DC]	24 (+10/-15%)		
Edge steepness (IC and MP only)	[V/ms]	> 0.4 minimum voltage increase time to reach the high-current phase		
Limitation of the voltage peaks when switching off	[V DC]	38		
Residual ripple	[Vss]	4		
Electrical power consumption	[W]	0.6 (0.45 at 21 V); (with CPV10-M11H-... 0.65)	0.9 (0.65 at 21 V)	1.5 (0.95 at 21 V)
Duty cycle	[%]	100		
with pilot air supply	[bar]	-0.9 ... +10		
Protection against electric shock (protection against direct and indirect contact to EN 60204-1/IEC 204)		By means of PELV power supply unit		
Protection class to EN 60529	[IP]	65 (for all types of signal transmission in assembled state)		

Relay plate		CPV10	CPV14	CPV18
Operating voltage	[V DC]	20.4 ... 26.4		-
Electrical power consumption	[W]	1.2		-
No. of relays		2 with galvanically isolated outputs		-
Load current circuit		Each 1 A/24 V DC +10%		-
Relay response times	On	[ms]	5	-
	Off	[ms]	2	-

Valve switching times [ms]		M	MK	F	J	JK	N	NK	C	CK	CY	H	HK	G	D	DK	I	IK	A	E
CPV10																				
Switching times	On	17	17	12	-	-	17	17	17	17	17	17	17	20	15	15	15	15	-	15
	Off	27	27	17	-	-	25	25	25	25	25	25	25	30	17	17	17	17	-	17
	Changeover	-	-	-	10	10	-	-	-	-	-	-	-	-	-	-	-	-	-	-
CPV14																				
Switching times	On	25	25	-	-	-	24	24	24	24	-	24	24	22	13	13	13	13	-	13
	Off	35	35	-	-	-	30	30	30	30	-	30	30	30	16	16	16	16	-	16
	Changeover	-	-	-	12	12	-	-	-	-	-	-	-	-	-	-	-	-	-	-
CPV18																				
Switching times	On	18	-	-	-	-	18	-	18	-	-	-	-	14	14	-	14	-	-	14
	Off	26	-	-	-	-	24	-	24	-	-	-	-	32	20	-	20	-	-	20
	Changeover	-	-	-	12	-	-	-	-	-	-	-	-	-	-	-	-	-	-	-

# Valve terminals type 10 CPV, Compact Performance, NPT

Technical data

Materials			
	CPV10	CPV14	CPV18
Basic electrical unit	Die-cast aluminium, polyamide, nitrile rubber		
Valve slices	Die-cast aluminium		
Valve module 5/3G	Cast aluminium, polyacetal		
Relay plate	Polyamide, brass		
Blanking plate/separator plate	Polyamide		
End plates	Die-cast aluminium		
Flat plate silencer	Die-cast aluminium, polyethylene		
Pneumatic multiple connector plate	Wrought aluminium alloy		
Inscription label holder	Polyacetal, polyvinyl chloride		
Seal	Nitrile rubber, hydrogenated nitrile rubber		

Product weight				
Approx. weight	[g]	CPV10	CPV14	CPV18
Electrical connection plates with AS-i connection				
• on CP valve terminals with 2 valve positions		85	130	275
• on CP valve terminals with 4 valve positions		110	175	355
• on CP valve terminals with 8 valve positions		400	460	–
Electrical connection plates with CP connection				
• on CP valve terminals with 4 valve positions		145	230	375
• on CP valve terminals with 6 valve positions		180	250	450
• on CP valve terminals with 8 valve positions		200	300	540
Electrical connection plates with MP connection				
• on CP valve terminals with 4 valve positions		110	170	400
• on CP valve terminals with 6 valve positions		140	230	425
• on CP valve terminals with 8 valve positions		165	275	515
End plates (2 pieces)		160	280	740
Pneumatic multiple connector plate				
• on CP valve terminals with 2 valve positions		120	270	520
• on CP valve terminals with 4 valve positions		165	390	750
• on CP valve terminals with 6 valve positions		225	510	870
• on CP valve terminals with 8 valve positions		270	630	1,300
Flat plate silencer		147	234	–
Relay plate		35	55	–
Blanking plate		25	45	90
Separator plate		25	45	90
Valve sub-bases, vacuum generators		70	110	260
Function block: 5/3G function		46	105	–
Function block: one-way flow control valves		25	54	125



# Valve terminals type 10 CPV, Compact Performance, NPT

Technical data

## Vacuum generator

Vacuum as a function of operating pressure

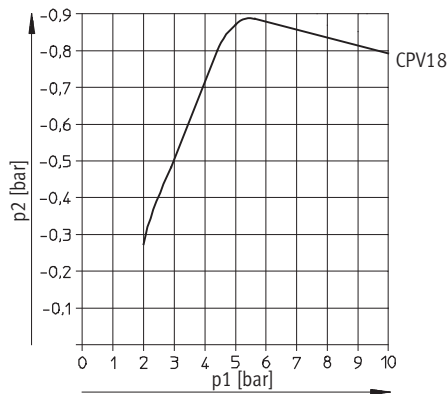
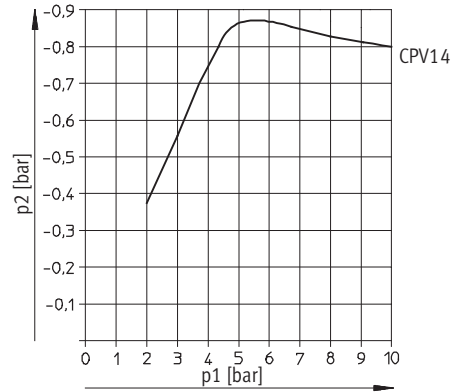
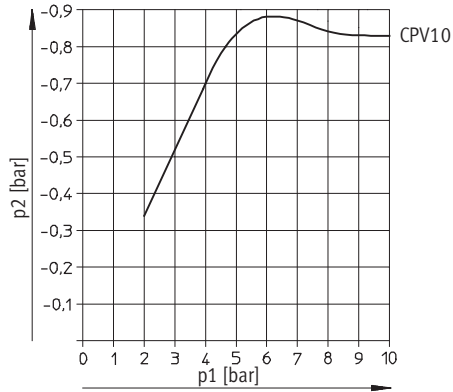

## Air consumption as a function of operating pressure

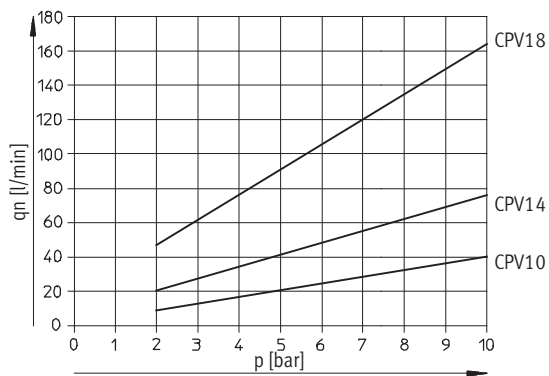

## Evacuation time for a volume of 1 litre at P<sub>nominal</sub>

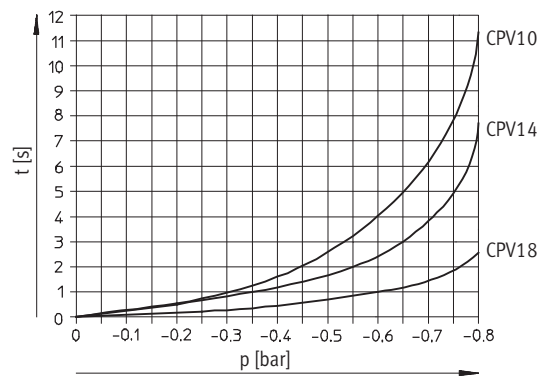

## Suction capacity as a function of vacuum at P<sub>nominal</sub>

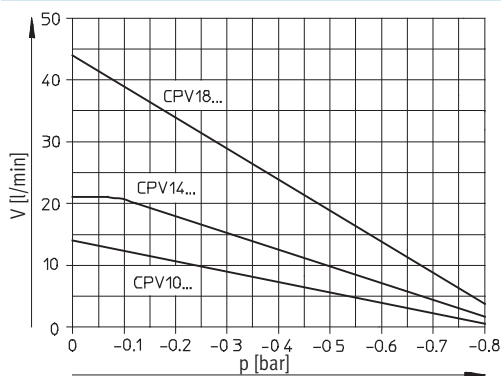

# Valve terminals type 10 CPV, Compact Performance, NPT

Technical data

## Dimensions

Download CAD data → [www.festo.com](http://www.festo.com)

Valve terminal with individual connection – CPV10/14/18

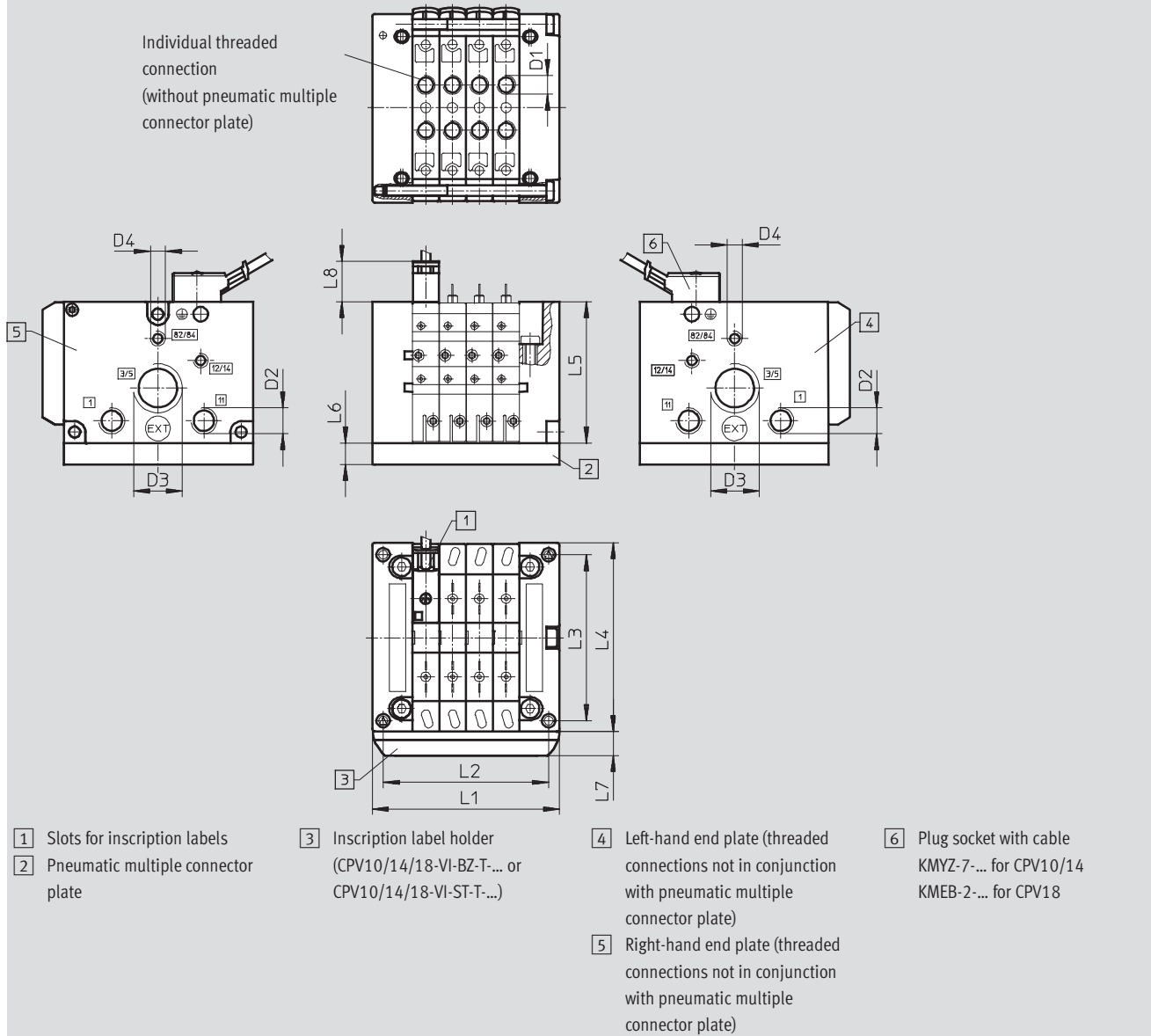

# Valve terminals type 10 CPV, Compact Performance, NPT

Technical data

	L1	L2	L3	L4	L5	L6	L7	L8	D1	D2	D3	D4	
CPV10	2-valve	50	41.8	62	71	52.8	15	9.5	11.8	M7	G $\frac{1}{8}$	G $\frac{3}{8}$	M5
	3-valve	60	51.8										
	4-valve	70	61.8										
	5-valve	80	71.8										
	6-valve	90	81.8										
	7-valve	100	91.8										
	8-valve	110	101.8										
CPV14	2-valve	68	58	78	89	58.8	20	9.5	11.8	G $\frac{1}{8}$	G $\frac{1}{4}$	G $\frac{1}{2}$	G $\frac{1}{8}$
	3-valve	82	72										
	4-valve	96	86										
	5-valve	110	100										
	6-valve	124	114										
	7-valve	138	128										
	8-valve	152	142										
CPV18	2-valve	96	85.5	106.5	118	73	20	9.5	21.6	G $\frac{1}{4}$	G $\frac{3}{8}$	G $\frac{1}{2}$	G $\frac{1}{4}$
	3-valve	114	103.5										
	4-valve	132	121.5										
	5-valve	150	139.5										
	6-valve	168	157.5										
	7-valve	186	175.5										
	8-valve	204	193.5										

# Valve terminals type 10 CPV, Compact Performance, NPT

Technical data

## Dimensions

Download CAD data → [www.festo.com](http://www.festo.com)

Valve terminal with individual connection and flat plate silencer- CPV10/14/18

Individual threaded connection  
(without pneumatic multiple connector plate)

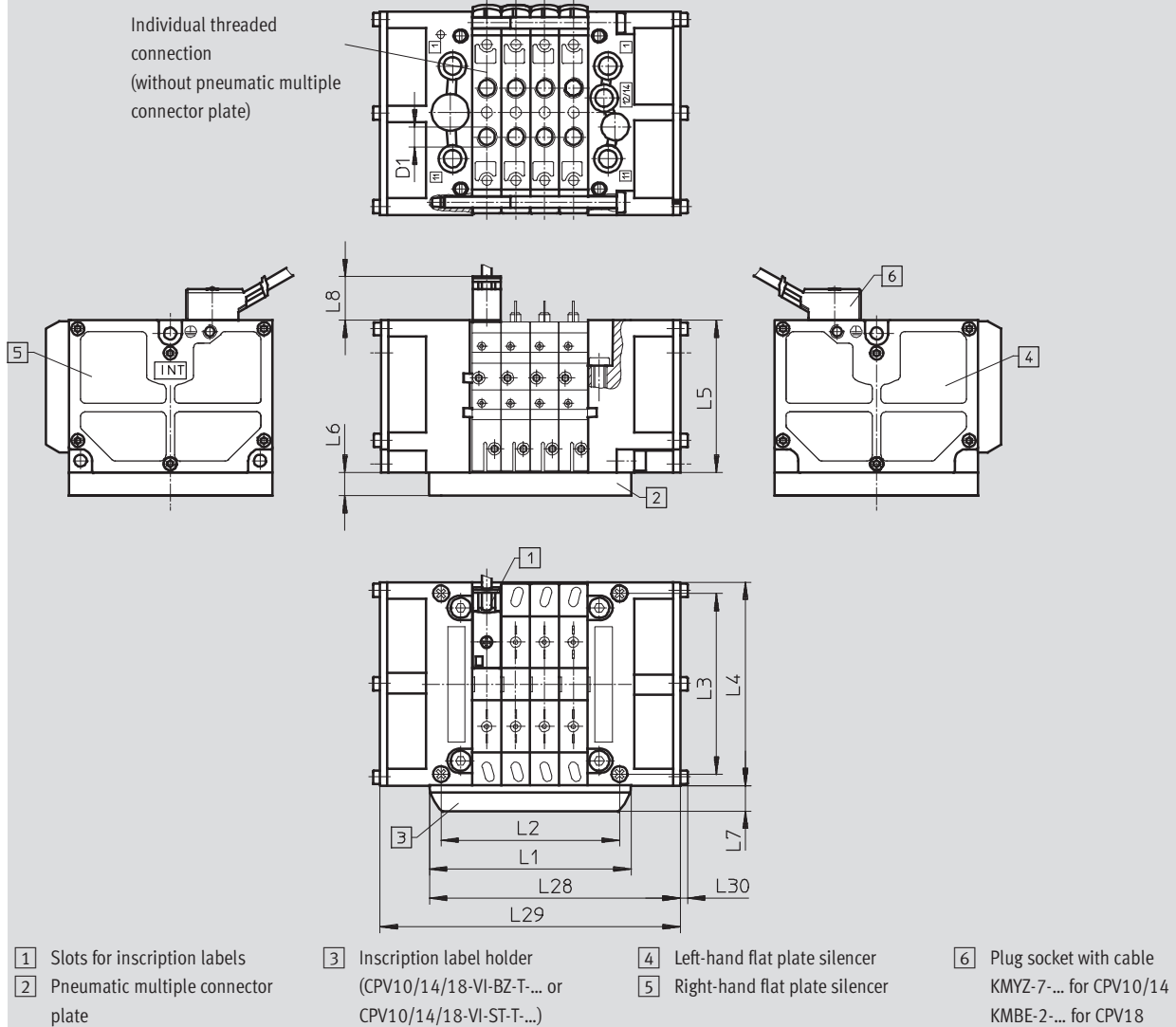

# Valve terminals type 10 CPV, Compact Performance, NPT

Technical data

	L1	L2	L3	L4	L5	L6	L7	L8	L28	L29	L30	D1	
CPV10	2-valve	50	41.8	62	71	52.8	15	9.5	11.8	67	84	2.5	M7
	3-valve	60	51.8							77	94		
	4-valve	70	61.8							87	104		
	5-valve	80	71.8							97	114		
	6-valve	90	81.8							107	124		
	7-valve	100	91.8							117	134		
	8-valve	110	101.8							127	144		
	CPV14	2-valve	68							58	78		
3-valve		82	72	99	116								
4-valve		96	86	113	130								
5-valve		110	100	127	144								
6-valve		124	114	141	158								
7-valve		138	128	155	172								
8-valve		152	142	169	186								
CPV18		2-valve	96	85.5	106.5	118	73	20	9.5	21.6		127	158
	3-valve	114	105.5	145							176		
	4-valve	132	121.5	163							194		
	5-valve	150	139.5	181							212		
	6-valve	168	157.5	199							230		
	7-valve	186	175.5	217							248		
	8-valve	204	193.5	235							266		

# Valve terminals type 10 CPV, Compact Performance, NPT

Technical data

Dimensions Download CAD data → [www.festo.com](http://www.festo.com)

Valve terminal with multi-pin plug connection – CPV10/14/18

1 Slots for inscription labels      2 Pneumatic multiple connector plate      3 Inscription label holder (CPV10/14/18-VI-BZ-T... or CPV10/14/18-VI-ST-T...)

		L1	L2	L3	L4	L5	L6	L7	L9	L10	L11	L12	L13
CPV10	4-valve	70	61.8	62	71	52.8	15	9.5	39.5	10	50	23.5	58.8
	6-valve	90	81.8							10	70		
	8-valve	110	101.8							20	70		
CPV14	4-valve	96	86	78	89	58.8	20	9.5	61.8	23	50	23.5	58.8
	6-valve	124	114							27	70		
	8-valve	152	142							41	70		
CPV18	4-valve	132	121.5	106.5	118	73	20	9.5	88.4	41	50	28	63
	6-valve	168	157.5							49	70		
	8-valve	204	193.5							67	70		

# Valve terminals type 10 CPV, Compact Performance, NPT

Technical data

**Dimensions**

Download CAD data → [www.festo.com](http://www.festo.com)

Valve terminal with AS-interface connection – CPV10/14/18

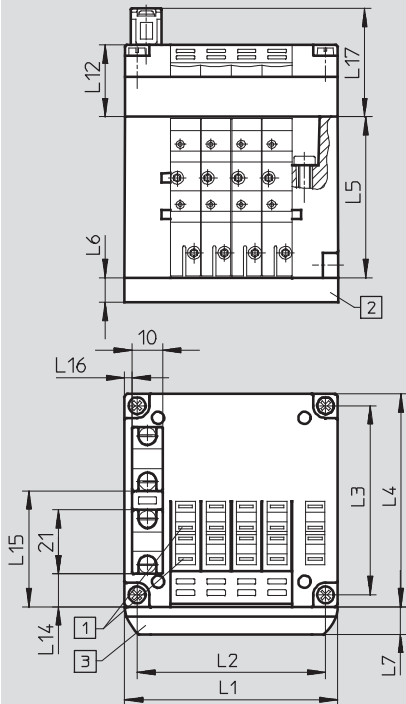

- 1 Slots for inscription labels
- 2 Pneumatic multiple connector plate
- 3 Inscription label holder (CPV10/14/18-VI-BZ-T... or CPV10/14/18-VI-ST-T...)

		L1	L2	L3	L4	L5	L6	L7	L12	L14	L15	L16	L17
CPV10	2-valve	50	41.8	62	71	52.8	15	9.5	-	10.9	38.1	2.5	35.5
	4-valve	70	61.8						23.5				
	8-valve	110	101.8						-				
CPV14	2-valve	68	58	78	89	58.8	20	9.5	-	14	52	5	35.5
	4-valve	96	86						23.5				
	8-valve	152	142						-				
CPV18	2-valve	96	85.5	106.5	118	73	20	9.5	-	27.4	68.2	10.4	40
	4-valve	132	121.5						28				
	8-valve	204	193.5						-				

# Valve terminals type 10 CPV, Compact Performance, NPT

Technical data

Dimensions Download CAD data → [www.festo.com](http://www.festo.com)

Valve terminal with AS-interface connection and additional inputs – CPV10/14

1 Slots for inscription labels  
 2 Pneumatic multiple connector plate  
 3 Inscription label holder (CPV10/14/18-VI-BZ-T... or CPV10/14/18-VI-ST-T...)

Valve terminal with AS-interface connection and additional inputs – CPV10

1 Slots for inscription labels  
 2 Pneumatic multiple connector plate  
 3 Inscription label holder (CPV10/14/18-VI-BZ-T... or CPV10/14/18-VI-ST-T...)

	L1	L2	L3	L4	L5	L6	L7	L18	L19	L20	L21	
CPV10	4-valve	70	61.8	62	71	52.8	15	9.5	10.9	38.1	35	3
	8-valve	110	101.8						10.4	38.6	31.9	
CPV14	4-valve	96	86	78	89	58.8	20	18.8	46.8	43.3	5	



# Valve terminals type 10 CPV, Compact Performance, NPT

Technical data

**Dimensions**

Download CAD data → [www.festo.com](http://www.festo.com)

Valve terminal with AS-interface connection and additional inputs – CPV14

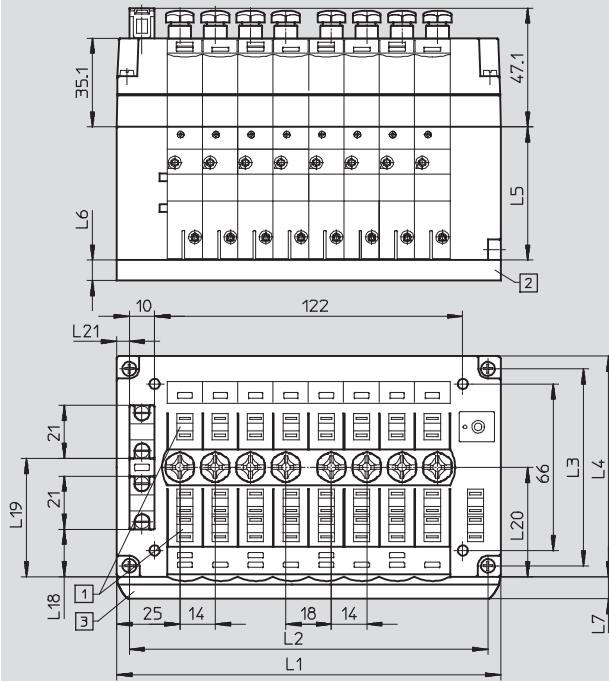

- 1 Slots for inscription labels
- 2 Pneumatic multiple connector plate
- 3 Inscription label holder (CPV10/14/18-VI-BZ-T... or CPV10/14/18-VI-ST-T...)

		L1	L2	L3	L4	L5	L6	L7	L18	L19	L20	L21
CPV14	8-valve	152	142	78	89	58.8	20	9.5	18.8	46.8	46.3	5

# Valve terminals type 10 CPV, Compact Performance, NPT

Technical data

## Dimensions

Download CAD data → [www.festo.com](http://www.festo.com)

Valve terminal with CPI installation system – CPV10/14/18

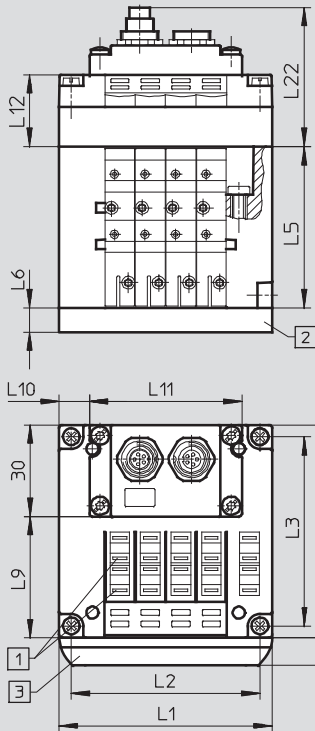

- 1 Slots for inscription labels
- 2 Pneumatic multiple connector plate
- 3 Inscription label holder (CPV10/14/18-VI-BZ-T-... or CPV10/14/18-VI-ST-T-...)

		L1	L2	L3	L4	L5	L6	L7	L9	L10	L11	L12	L22
CPV10	4-valve	70	61.8	62	71	52.8	15	9.5	39.5	10	50	23.5	46
	6-valve	90	81.8							10	70		
	8-valve	110	101.8							20	70		
CPV14	4-valve	96	86	78	89	58.8	20	9.5	61.8	23	50	23.5	46
	6-valve	124	114							27	70		
	8-valve	152	142							41	70		
CPV18	4-valve	132	121.5	106.5	118	73	20	9.5	88.4	41	50	28	50.5
	6-valve	168	157.5							49	70		
	8-valve	204	193.5							67	70		

# Valve terminals type 10 CPV, Compact Performance, NPT

Technical data

Dimensions Download CAD data → [www.festo.com](http://www.festo.com)

Valve terminal with Fieldbus Direct – CPV10/14/18 Interbus

1 Slots for inscription labels  
2 Pneumatic multiple connector plate  
3 Inscription label holder (type CPV10/14/18-VI-BZ-T... or CPV10/14/18-VI-ST-T...)

Valve terminal with Fieldbus Direct – CPV10/14/18 DeviceNet, CANopen, CC-Link

1 Slots for inscription labels  
2 Pneumatic multiple connector plate  
3 Inscription label holder (type CPV10/14/18-VI-BZ-T... or CPV10/14/18-VI-ST-T...)

	L1	L2	L3	L4	L5	L6	L7	L23	L24	L25	L26	L27	L28	L29
CPV10 8-valve	110	101.8	62	71	52.8	15	9.5	35.8	34.6	25	26.2	36.7	55.1	30.9
CPV14 8-valve	152	142	78	89	58.8	20	9.5	52.8	34.6	46	26.2	36.7	55.1	30.9
CPV18 8-valve	204	193.5	106.5	118	73	20	9.5	79.8	36.6	72	31.2	41.7	59.6	35.9

# Valve terminals type 10 CPV, Compact Performance, NPT

Technical data

**Dimensions**

Download CAD data → [www.festo.com](http://www.festo.com)

Valve terminal with Fieldbus Direct – CPV10/14/18

Profibus DP including Festo fieldbus, ABB CS31, Moeller Suconet K

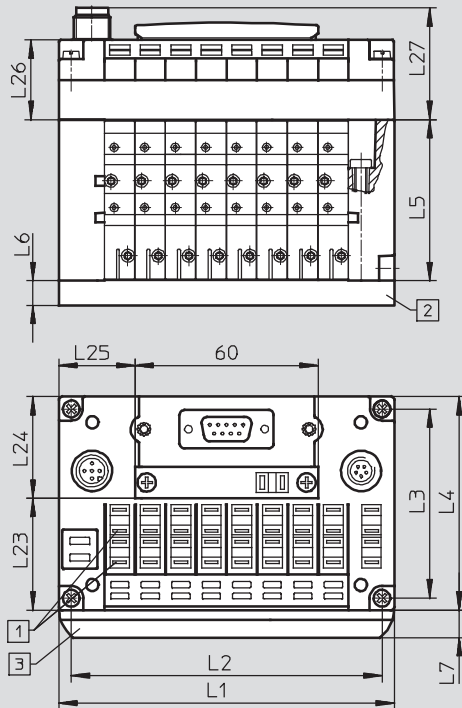

- 1 Slots for inscription labels
- 2 Pneumatic multiple connector plate
- 3 Inscription label holder (CPV10/14/18-VI-BZ-T... or CPV10/14/18-VI-ST-T...)

		L1	L2	L3	L4	L5	L6	L7	L23	L24	L25	L26	L27
CPV10	8-valve	110	101.8	62	71	52.8	15	9.5	35.5	34.6	25	26.2	36.7
CPV14	8-valve	152	142	78	89	58.8	20	9.5	52.8	34.6	46	26.2	36.7
CPV18	8-valve	204	193.5	106.5	118	73	20	9.5	79.8	36.6	72	31.2	41.7

# Valve terminals type 10 CPV, Compact Performance, NPT

Technical data

**Dimensions**

Download CAD data → [www.festo.com](http://www.festo.com)

Attachment for wall mounting CPV10/14-VI-BG-RWL-B for CPV10/14

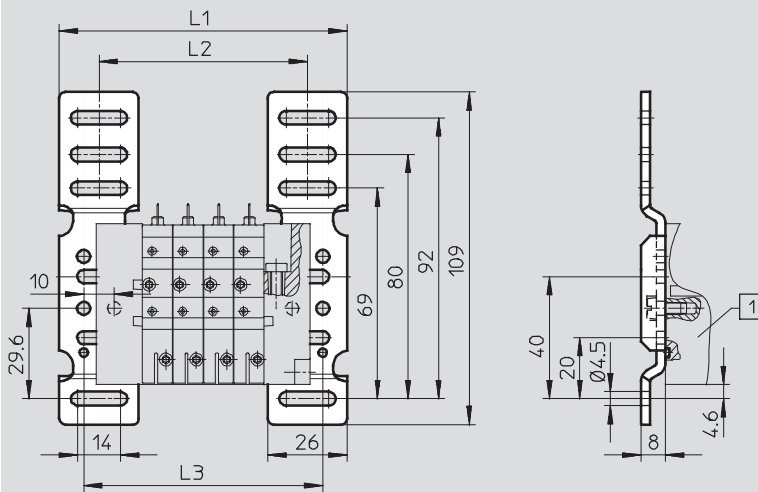

1 Valve terminal CPV-...

	CPV10							CPV14						
	2-valve	3-valve	4-valve	5-valve	6-valve	7-valve	8-valve	2-valve	3-valve	4-valve	5-valve	6-valve	7-valve	8-valve
L1	74	84	94	104	114	124	134	90	104	118	132	146	160	174
L2	48	58	68	78	88	98	108	64	78	92	106	120	134	148
L3	58	68	78	88	98	108	118	74	88	102	116	130	144	158

Attachment for wall mounting CPV18-VI-BG-RW for CPV18

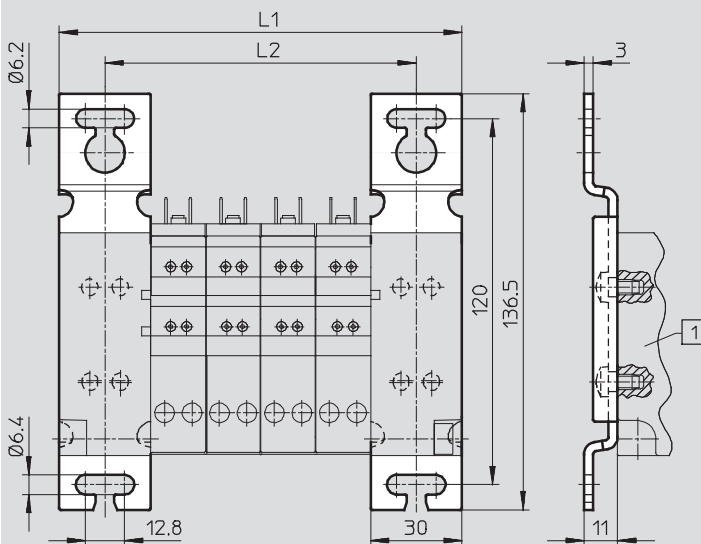

1 Valve terminal CPV-...

	CPV18						
	2-valve	3-valve	4-valve	5-valve	6-valve	7-valve	8-valve
L1	96	114	132	150	168	186	204
L2	66	84	102	120	138	156	174

# Valve terminals type 10 CPV, Compact Performance, NPT

Technical data

## Dimensions

Download CAD data → [www.festo.com](http://www.festo.com)

Attachment CPV10-VI-BG-ET200X for individual connection and ET200X

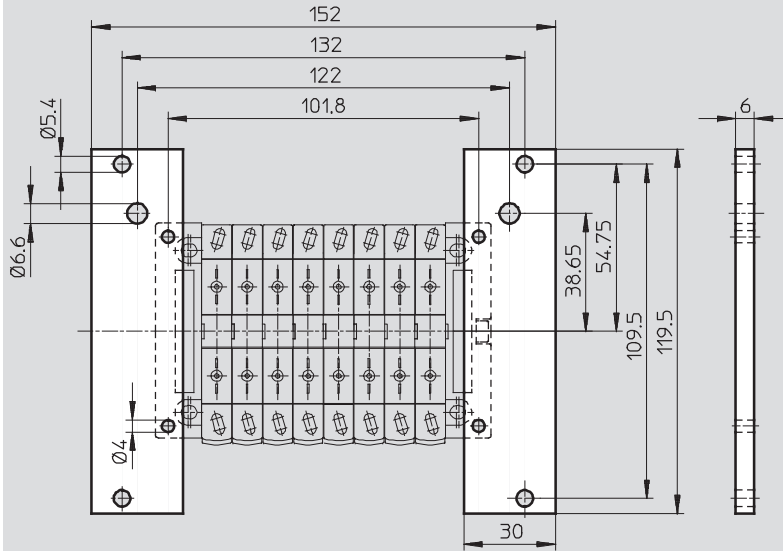

Attachment CPV14-VI-BG-ET200X for individual connection and ET200X

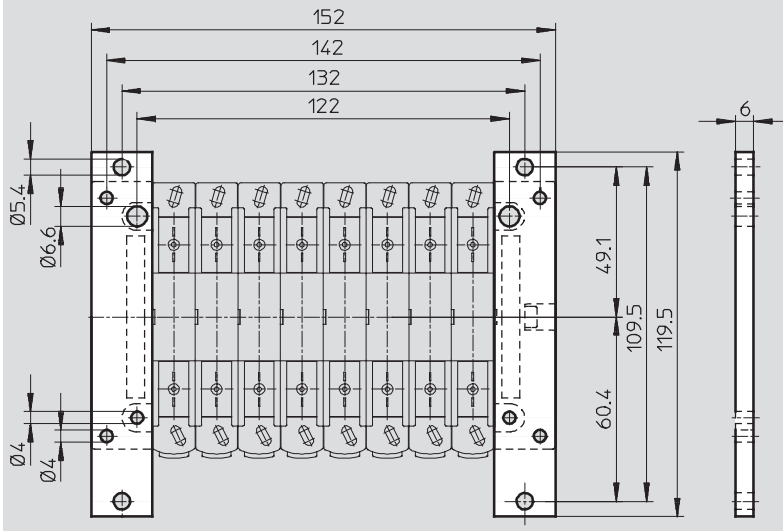

# Valve terminals type 10 CPV, Compact Performance, NPT

Technical data

## Dimensions

Download CAD data → [www.festo.com](http://www.festo.com)

Attachment for H-rail mounting CPV10/14-VI-BG-NRH-35

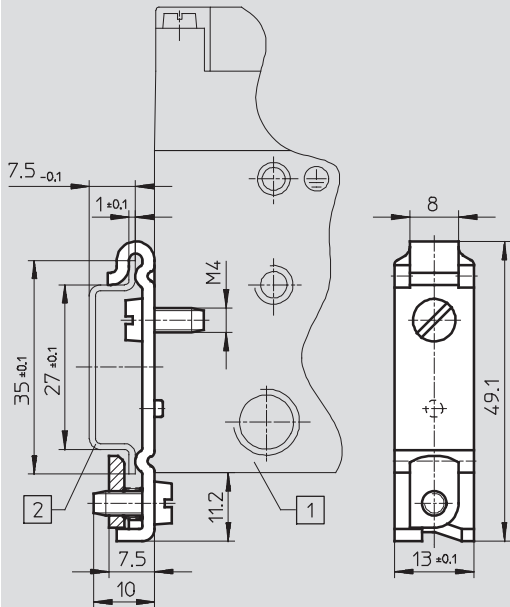

1 Valve terminal CPV10/14

2 H-rail to EN 60715

Attachment for H-rail mounting CPV18-VI-BG-NRH-35

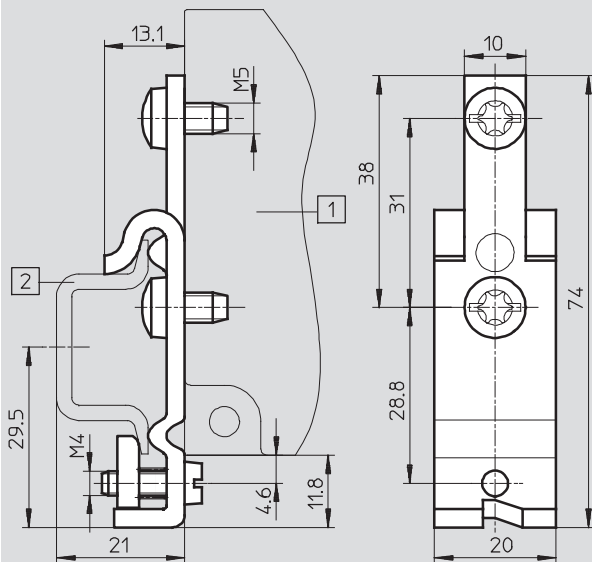

1 Valve terminal CPV18

2 H-rail to EN 60715

# Valve terminals type 10 CPV, Compact Performance, NPT

Technical data

**Dimensions**

Download CAD data → [www.festo.com](http://www.festo.com)

Pneumatic multiple connector plate – CPV10/14/18

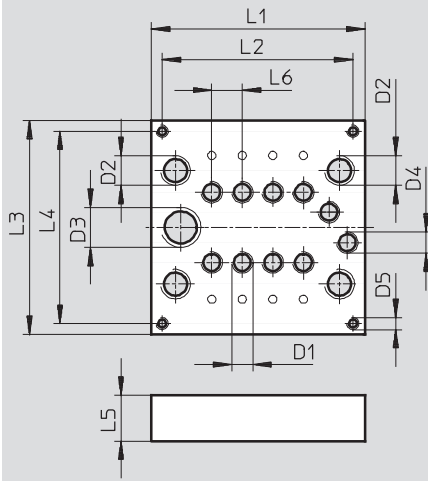

		L1	L2	L3	L4	L5	L6	D1	D2	D3	D4	D5
CPV10	2-valve	49.5	42.5	70	63	15	10	M7	G $\frac{1}{8}$	G $\frac{1}{4}$	M7	M4
	4-valve	69.5	62.5									
	6-valve	89.5	82.5									
	8-valve	109.5	102.5									
CPV14	2-valve	67.5	53.5	86.6	76.6	20	14	G $\frac{1}{8}$	G $\frac{1}{4}$	G $\frac{3}{8}$	G $\frac{1}{8}$	M4
	4-valve	95.5	81.5									
	6-valve	123.5	109.5									
	8-valve	151.5	137.5									
CPV18	2-valve	95.5	87.5	119.6	108	20	18	G $\frac{1}{4}$	G $\frac{3}{8}$	G $\frac{1}{2}$	G $\frac{1}{4}$	M5
	4-valve	131	123									
	6-valve	167	159									
	8-valve	203	195									



# Valve terminals type 10 CPV, Compact Performance, NPT

Technical data

**Dimensions**

Download CAD data → [www.festo.com](http://www.festo.com)

Flanged pneumatic multiple connector plate– CPV10/14/18

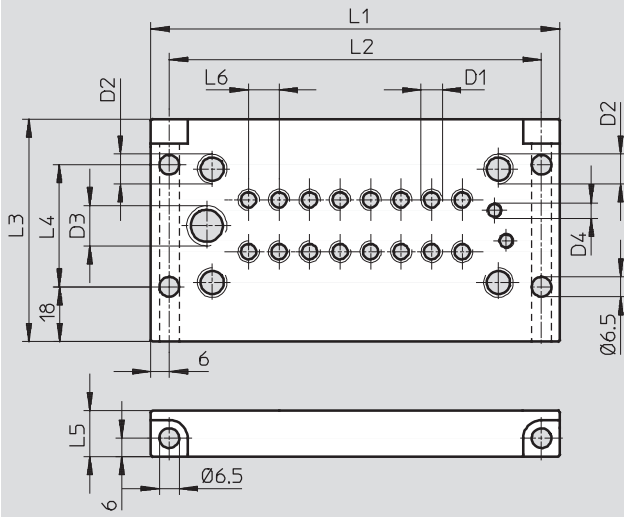

		L1	L2	L3	L4	L5	L6	D1	D2	D3	D4
CPV10	2-valve	74	62	73	40	15	10	M7	G1/8	G1/4	M5
	4-valve	94	82								
	6-valve	114	102								
	8-valve	134	122								
CPV14	2-valve	92	80	89	59	20	14	G1/8	G1/4	G3/8	G1/8
	4-valve	120	108								
	6-valve	148	136								
	8-valve	176	164								
CPV18	2-valve	119	107	118	88	20	18	G1/4	G3/8	G1/2	G1/4
	4-valve	155	143								
	6-valve	191	179								
	8-valve	227	215								

# Valve terminals type 10 CPV, Compact Performance, NPT

Technical data

**Dimensions** Download CAD data → [www.festo.com](http://www.festo.com)  
 Pneumatic multiple connector plate for control cabinet installation, without supply ports – CPV10/14

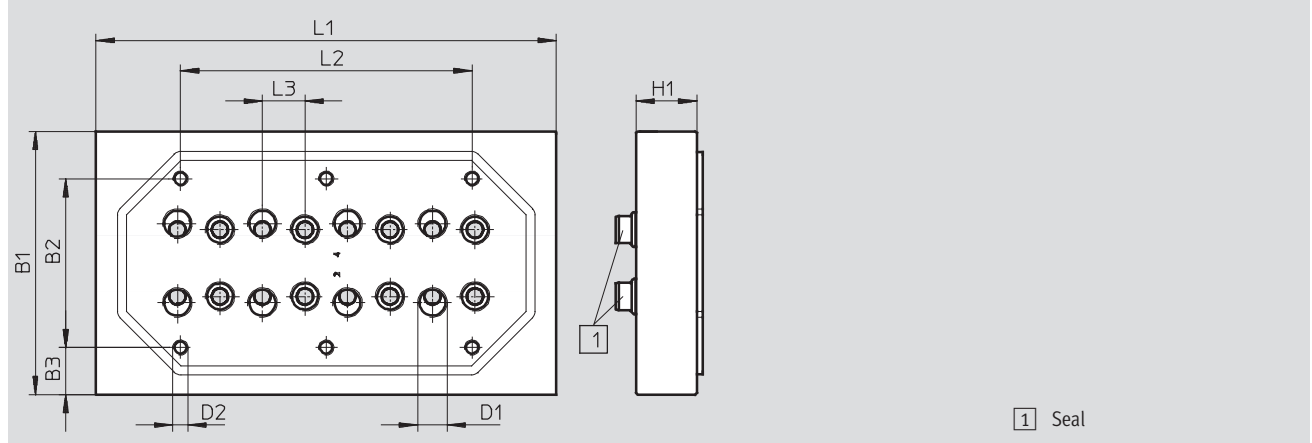

		L1	L2	L3	B1	B2	B3	D1	D2	H1
CPV10	2-valve	49.5	–	10	70	40	15	M7	M5	10
	4-valve	69.5	28							
	6-valve	89.5	49							
	8-valve	109.5	68							
CPV14	2-valve	67.5	13	14	86.6	55.6	15.5	G1/8	M5	14
	4-valve	95.5	40							
	6-valve	123.5	68							
	8-valve	151.5	96							

Pneumatic multiple connector plate for control cabinet installation, with supply ports – CPV10/14

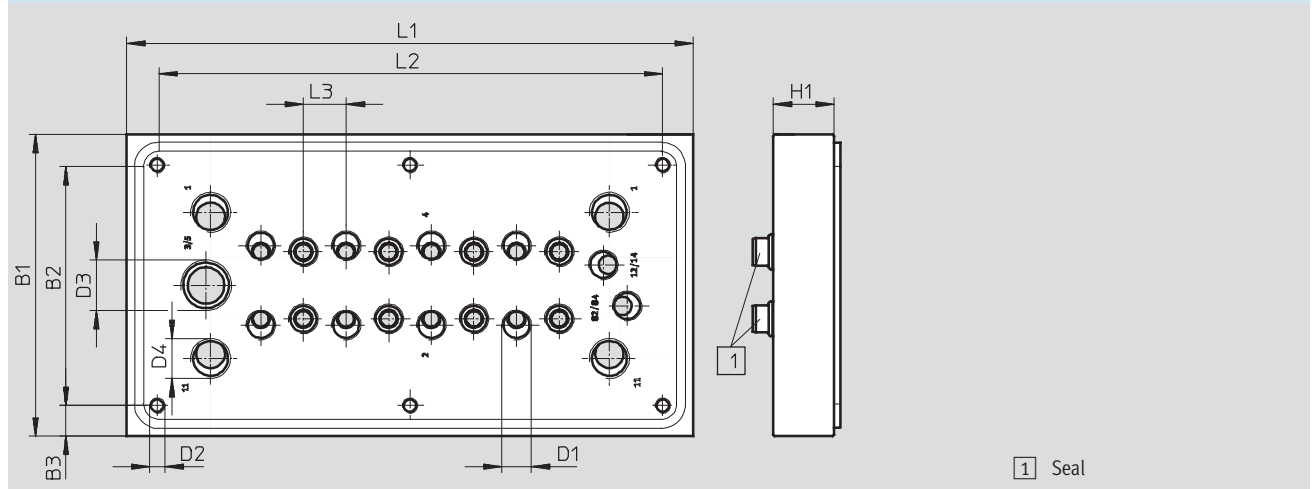

		L1	L2	L3	B1	B2	B3	D1	D2	D3	D4	H1
CPV10	2-valve	82	62	10	84	64	10	M7	M5	G1/4	G1/8	15
	4-valve	102	82									
	6-valve	122	102									
	8-valve	142	122									
CPV14	2-valve	102	82	14	99	79	10	G1/8	M5	G3/8	G1/4	20
	4-valve	130	110									
	6-valve	158	138									
	8-valve	186	166									

# Valve terminals type 10 CPV, Compact Performance, NPT

Technical data

## Dimensions

Download CAD data → [www.festo.com](http://www.festo.com)

Valve kit for 5/3 function – CPV10/14

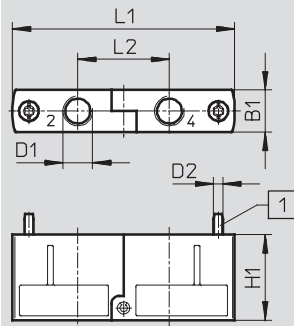

1 Mounting screw enclosed separately

Type	B1	D1	D2	H1	L1	L2
CPV10-BS-5/3G-M7	9.9	M7	M2.5	22	55.8	23
CPV14-BS-5/3G-1/8	13.8	G1/8	M3	28	72.8	30

Additional one-way flow control valve function – CPV10/14

CPV10/14-...-BS-2xGR...-...

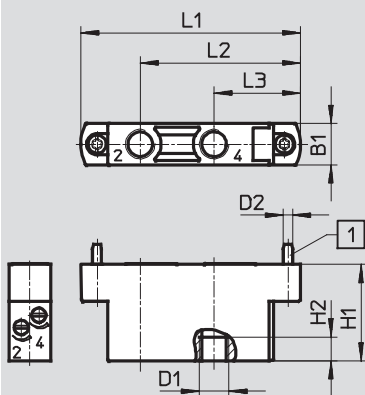

1 Mounting screw enclosed separately

Additional one-way flow control valve function for vacuum – CPV10/14

CPV...-BS-2xGRZ-V-...

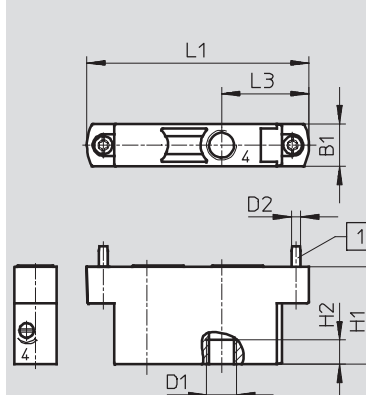

Type	B1	D1	D2	H1	H2	L1	L2	L3
CPV10-BS-2xGR...-M7	9.9	M7	M2.5	26	6	55.8	41.4	22.9
CPV10-BS-2xGRZ-V...-M7							-	
CPV14-BS-2xGR...-1/8	13.8	G1/8	M3	32	8	72.8	53.15	28.65
CPV14-BS-2xGRZ-V...-1/8							-	

# Valve terminals type 10 CPV, Compact Performance, NPT

Technical data

Dimensions Download CAD data → [www.festo.com](http://www.festo.com)

Fieldbus connection FBS-SUB-9-BU-2x4POL

1 Valve terminal with Fieldbus Direct CPV10/14/18 and fieldbus node for DeviceNet and CANopen

2 Sub-D socket, 9-pin

	CPV10 8-valve	CPV14 8-valve	CPV18 8-valve
L1	24.5	45.5	71.5

Fieldbus connection FBSD-KL-2x5POL

1 Valve terminal with Fieldbus Direct CPV10/14/18 and fieldbus node for DeviceNet and CANopen

2 Sub-D socket, 9-pin

3 Fieldbus connection FBSD-KL-2x5pol

	CPV10 8-valve	CPV14 8-valve	CPV18 8-valve
L1	24	45	71

# Valve terminals type 10 CPV, Compact Performance, NPT

Accessories

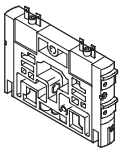
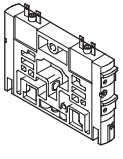
Ordering data				
	Code	Valve function	Part No.	Type
<b>Individual sub-base valve sizes 10/14/18</b>				
	M	5/2-way valve, single solenoid, piston spool valve	161414	CPV10-M1H-5LS-M7
			161360	CPV14-M1H-5LS-1/8
			163190	CPV18-M1H-5LS-1/4
	F	5/2-way valve, single solenoid, fast switching, piston spool valve	187439	CPV10-M11H-5LS-M7
	J	5/2-way valve, double solenoid, piston spool valve	161415	CPV10-M1H-5JS-M7
			161361	CPV14-M1H-5JS-1/8
			163191	CPV18-M1H-5JS-1/4
	N	2x 3/2-way valve, normally open, piston spool valve	161417	CPV10-M1H-2x3-OLS-M7
			161363	CPV14-M1H-2x3-OLS-1/8
			163188	CPV18-M1H-2x3-OLS-1/4
	C	2x 3/2-way valve, normally closed, piston spool valve	161416	CPV10-M1H-2x3-GLS-M7
			161362	CPV14-M1H-2x3-GLS-1/8
			163189	CPV18-M1H-2x3-GLS-1/4
	CY	2x 3/2-way valve, normally closed, integrated back pressure protection, piston spool valve	553260	CPV10-M1H-2x3-GLS-Y-M7
	H	2x 3/2-way valve, 1x normally open, 1x closed, piston spool valve	176064	CPV10-M1H-30LS-3GLS-M7
			176067	CPV14-M1H-30LS-3GLS-1/8
			176070	CPV18-M1H-30LS-3GLS-1/4
	G	5/3-way valve, mid-position closed, piston spool valve	176061	CPV18-M1H-5/3GS-1/4
	D	2x 2/2-way valve, normally closed, piston spool valve	185880	CPV10-M1H-2x2-GLS-M7
			185883	CPV14-M1H-2x2-GLS-1/8
			185886	CPV18-M1H-2x2-GLS-1/4
I	2x 2/2-way valve, 1x normally open, 1x closed, piston spool valve	187843	CPV10-M1H-20LS-2GLS-M7	
		187846	CPV14-M1H-20LS-2GLS-1/8	
		187849	CPV18-M1H-20LS-2GLS-1/4	
<b>Individual sub-base valve with duct separation 1, 11 sizes 10/14</b>				
	MK	5/2-way valve (with duct separation 1, 11), single solenoid, piston spool valve	553256	CPV10-M1H-5LS-K-M7
			553258	CPV14-M1H-5LS-K-1/8
	JK	5/2-way valve (with duct separation 1, 11), double-solenoid, piston spool valve	559644	CPV10-M1H-5JS-K-M7
			559651	CPV14-M1H-5JS-K-1/8
	NK	2x 3/2-way valve (with duct separation 1, 11), normally open, piston spool valve	559641	CPV10-M1H-2x3-OLS-K-M7
			559648	CPV14-M1H-2x3-OLS-K-1/8
	CK	2x 3/2-way valve (with duct separation 1, 11), normally closed, piston spool valve	553257	CPV10-M1H-2x3-GLS-K-M7
			553259	CPV14-M1H-2x3-GLS-K-1/8
	HK	2x 3/2-way valve (with duct separation 1, 11), 1x normally open, 1x closed, piston spool valve	559642	CPV10-M1H-30LS-3GLS-K-M7
			559649	CPV14-M1H-30LS-3GLS-K-1/8
	DK	2x 2/2-way valve (with duct separation 1, 11), normally closed, piston spool valve	559645	CPV10-M1H-2x2-GLS-K-M7
			559652	CPV14-M1H-2x2-GLS-K-1/8
	IK	2x 2/2-way valve (with duct separation 1, 11), 1x normally open, 1x closed, piston spool valve	559646	CPV10-M1H-20LS-2GLS-K-M7
			559653	CPV14-M1H-20LS-2GLS-K-1/8

# Valve terminals type 10 CPV, Compact Performance, NPT

FESTO

Accessories

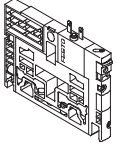
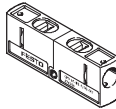
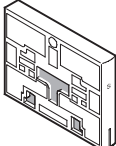
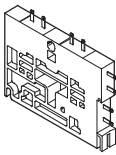
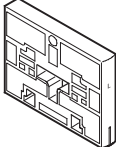
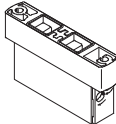
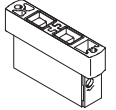
Ordering data				
	Code	Designation	Part No.	Type
<b>Vacuum generator</b>				
	A	Vacuum generator	185862	CPV10-M1H-V70-M7
			185868	CPV14-M1H-V95-1/8
			185874	CPV18-M1H-V140-1/4
	E	Vacuum generator with ejector pulse	185865	CPV10-M1H-VI70-2GLS-M7
			185871	CPV14-M1H-VI95-2GLS-1/8
			185877	CPV18-M1H-VI140-2GLS-1/4
<b>Function block</b>				
	G	Valve kit for 5/3-way valve function, closed (in combination with valve slice C) for size 10 and 14	176055	CPV10-BS-5/3G-M7
			176057	CPV14-BS-5/3G-1/8
<b>Separator plates</b>				
	T	Separator plate, duct 1/11 closed	161369	CPV10-DZP
			162551	CPV14-DZP
			163282	CPV18-DZP
	S	Separator plate, duct 1/11, 3/5 closed	178678	CPV10-DZPR
			178680	CPV14-DZPR
			184543	CPV18-DZPR
<b>Relay plate</b>				
	R	Relay plate	174478	CPV10-RP2
			174480	CPV14-RP2
<b>Blanking plate</b>				
	L	Blanking plate	161368	CPV10-RZP
			162550	CPV14-RZP
			163283	CPV18-RZP
<b>Additional functions for valve positions</b>				
	P	One-way flow control valve, 2x supply air	184140	CPV10-BS-2XGRZZ-M7
			184142	CPV14-BS-2XGRZZ-1/8
	Q	One-way flow control valve, 2x exhaust air	184141	CPV10-BS-2XGRAZ-M7
			184143	CPV14-BS-2XGRAZ-1/8
	V	One-way flow control valve for vacuum	185889	CPV10-BS-GRZ-V-M7
			185891	CPV14-BS-GRZ-V-1/8

# Valve terminals type 10 CPV, Compact Performance, NPT

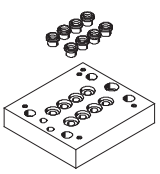

Accessories

Ordering data						
Designation			Part No.	Type		
Pneumatic multiple connector plate						
	M	Pneumatic multiple connector plate, for wall/machine mounting, without side flange	2-valve	161969 CPV10-VI-P2-M7		
			4-valve	161970 CPV10-VI-P4-M7		
			6-valve	161971 CPV10-VI-P6-M7		
			8-valve	163893 CPV10-VI-P8-M7		
			2-valve	163894 CPV14-VI-P2-1/8		
			4-valve	163895 CPV14-VI-P4-1/8		
			6-valve	163896 CPV14-VI-P6-1/8		
			8-valve	163897 CPV14-VI-P8-1/8		
			2-valve	165292 CPV18-VI-P2-1/4		
			4-valve	165293 CPV18-VI-P4-1/4		
			6-valve	165294 CPV18-VI-P6-1/4		
			8-valve	165295 CPV18-VI-P8-1/4		
			P	Pneumatic multiple connector plate, for wall/machine mounting, with side flange	2-valve	152420 CPV10-VI-P2-M7-B
					4-valve	152421 CPV10-VI-P4-M7-B
	6-valve	152422 CPV10-VI-P6-M7-B				
	8-valve	152423 CPV10-VI-P8-M7-B				
	2-valve	152424 CPV14-VI-P2-1/8-B				
	4-valve	152425 CPV14-VI-P4-1/8-B				
	6-valve	152426 CPV14-VI-P6-1/8-B				
	8-valve	152427 CPV14-VI-P8-1/8-B				
	2-valve	175632 CPV18-VI-P2-1/4-B				
	4-valve	175634 CPV18-VI-P4-1/4-B				
	6-valve	175636 CPV18-VI-P6-1/4-B				
	8-valve	175638 CPV18-VI-P8-1/4-B				
	GQC	Pneumatic multiple connector plate with sealing ring, for control cabinet assembly, with supply ports			2-valve	538807 CPV10-VI-P2-M7-C
					4-valve	538808 CPV10-VI-P4-M7-C
			6-valve	538809 CPV10-VI-P6-M7-C		
			8-valve	538810 CPV10-VI-P8-M7-C		
2-valve			539498 CPV14-VI-P2-1/8-C			
4-valve			539499 CPV14-VI-P4-1/8-C			
6-valve			539500 CPV14-VI-P6-1/8-C			
8-valve			539501 CPV14-VI-P8-1/8-C			
GQD	Pneumatic multiple connector plate with sealing ring, for control cabinet assembly, without supply ports	2-valve	538811 CPV10-VI-P2-M7-D			
		4-valve	538812 CPV10-VI-P4-M7-D			
		6-valve	538813 CPV10-VI-P6-M7-D			
		8-valve	538814 CPV10-VI-P8-M7-D			
		2-valve	539502 CPV14-VI-P2-1/8-D			
		4-valve	539503 CPV14-VI-P4-1/8-D			
		6-valve	539504 CPV14-VI-P6-1/8-D			
		8-valve	539505 CPV14-VI-P8-1/8-D			
GQE	Pneumatic multiple connector plate with sealing ring, for control cabinet assembly, with all ports	2-valve	566709 CPV10-VI-P2-1/8-C			
		4-valve	566710 CPV10-VI-P4-1/8-C			
		6-valve	566711 CPV10-VI-P6-1/8-C			
		8-valve	566712 CPV10-VI-P8-1/8-C			

# Valve terminals type 10 CPV, Compact Performance, NPT

FESTO

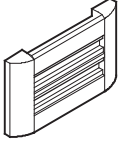
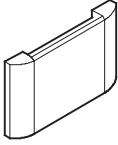
Accessories







Ordering data				
	Code	Designation	Part No.	Type
<b>Inscription label holder</b>				
	Z	Holder for inscription labels	162560	CPV10-VI-BZ-T-2
			162561	CPV10-VI-BZ-T-3
			162562	CPV10-VI-BZ-T-4
			162563	CPV10-VI-BZ-T-5
			162564	CPV10-VI-BZ-T-6
			162565	CPV10-VI-BZ-T-7
			162566	CPV10-VI-BZ-T-8
			162567	CPV14-VI-BZ-T-2
			162568	CPV14-VI-BZ-T-3
			162569	CPV14-VI-BZ-T-4
			162570	CPV14-VI-BZ-T-5
			162571	CPV14-VI-BZ-T-6
			162572	CPV14-VI-BZ-T-7
			162573	CPV14-VI-BZ-T-8
			163293	CPV18-VI-BZ-T-2
			163294	CPV18-VI-BZ-T-3
			163295	CPV18-VI-BZ-T-4
			163296	CPV18-VI-BZ-T-5
			163297	CPV18-VI-BZ-T-6
			163298	CPV18-VI-BZ-T-7
163299	CPV18-VI-BZ-T-8			
	T	Holder for inscription labels, transparent	194066	CPV10-VI-ST-T-2
			194067	CPV10-VI-ST-T-3
			194068	CPV10-VI-ST-T-4
			194069	CPV10-VI-ST-T-5
			194070	CPV10-VI-ST-T-6
			194071	CPV10-VI-ST-T-7
			194072	CPV10-VI-ST-T-8
			194073	CPV14-VI-ST-T-2
			194074	CPV14-VI-ST-T-3
			194075	CPV14-VI-ST-T-4
			194076	CPV14-VI-ST-T-5
			194077	CPV14-VI-ST-T-6
			194078	CPV14-VI-ST-T-7
			194079	CPV14-VI-ST-T-8
			194080	CPV18-VI-ST-T-2
			194081	CPV18-VI-ST-T-3
			194082	CPV18-VI-ST-T-4
			194083	CPV18-VI-ST-T-5
			194084	CPV18-VI-ST-T-6
			194085	CPV18-VI-ST-T-7
194086	CPV18-VI-ST-T-8			
<b>Inscription labels</b>				
	-	6x10 mm in frames, 64 pieces	18576	IBS 6x10
		9x20 mm in frames, 20 pieces (CPV18 only)	18182	IBS 9x20



# Valve terminals type 10 CPV, Compact Performance, NPT

FESTO



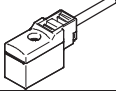
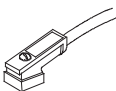

Accessories

Ordering data					
	Code	Designation		Part No.	Type
<b>Mounting attachments</b>					
	H	Attachment for H-rail		162556	CPV10/14-VI-BG-NRH-35
				163291	CPV18-VI-BG-NRH-35
	W	Attachment for wall mounting		163292	CPV18-VI-BG-RW
	U			189541	CPV10/14-VI-BG-RWL-B
	X	Attachment for individual connection and ET200X (included in the scope of delivery)		165801	CPV10-VI-BG-ET200X
				165803	CPV14-VI-BG-ET200X
<b>Manual override</b>					
	-	Locking clip (for manual override), non-detachable		526203	CPV10/14-HS
				526204	CPV18-HS
	V	Locking clip (cover for manual override), non-detachable		530055	CPV10/14-HV
				530056	CPV18-HV
<b>Relay plate</b>					
	K	Connecting cable for relay plate	2.5 m	165612	KRP-1-24-2,5
	L		5 m	165613	KRP-1-24-5
<b>Cable for individual connection, electrical</b>					
	D	Plug socket with cable for CPV10/14	2.5 m	193683	KMYZ-7-24-2,5-LED-PUR
	E		5 m	193685	KMYZ-7-24-5-LED-PUR
	F		10 m	196070	KMYZ-7-24-10-LED-PUR
	D	Plug socket with cable for CPV18	2.5 m	174844	KMEB-2-24-2,5-LED
	E		5 m	174845	KMEB-2-24-5-LED

# Valve terminals type 10 CPV, Compact Performance, NPT

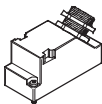
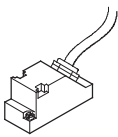
FESTO

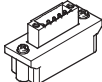
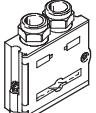

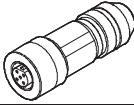
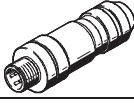
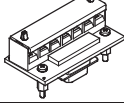



Accessories

Ordering data					
	Code	Designation	Part No.	Type	
<b>Multi-pin plug connection, electrical</b>					
	Y	Plug socket, 9-pin	18708	SD-SUB-D-BU9	
		Plug socket, 25-pin	18709	SD-SUB-D-BU25	
	R	Connecting cable, 9-pin, polyvinyl chloride	5 m	18698	KMP3-9P-08-5
		Connecting cable, 25-pin, polyvinyl chloride		18624	KMP3-25P-16-5
	S	Connecting cable, 9-pin, polyvinyl chloride	10 m	18579	KMP3-9P-08-10
		Connecting cable, 25-pin, polyvinyl chloride		18625	KMP3-25P-16-10
	-	Connecting cable, 9-pin, polyurethane	5 m	193014	KMP4-9P-5-PUR
		Connecting cable, 25-pin, polyurethane		193018	KMP4-25P-5-PUR
	-	Connecting cable, 9-pin, polyurethane	10 m	193015	KMP4-9P-10-PUR
		Connecting cable, 25-pin, polyurethane		193019	KMP4-25P-10-PUR
	-	Connecting cable, with 9-pin Sub-D plug, IP40, polyvinyl chloride cable	2.5 m	531184	KMP6-09P-8-2,5
			5 m	531185	KMP6-09P-8-5
			10 m	531186	KMP6-09P-8-10
	-	Connecting cable, with 25-pin Sub-D plug, IP40, polyvinyl chloride cable	2.5 m	530046	KMP6-25P-20-2,5
			5 m	530047	KMP6-25P-20-5
			10 m	530048	KMP6-25P-20-10
<b>Fieldbus connection for Fieldbus Direct</b>					
	GA	Straight socket, Sub-D 9-pin for DeviceNet/CANopen, plug/socket M12 5-pin, IP65	525632	FBA-2-M12-5POL	
	GB	Straight socket, Sub-D 9-pin for DeviceNet/CANopen, plug 5-pin, IP40	525634	FBA-1-SL-5POL	
		Angled socket 5-pin for DeviceNet/CANopen, screw terminal 5-pin, IP20	525635	FBSD-KL-2x5POL	
	GD	Plug 9-pin, Sub-D for DeviceNet/CANopen, IP65	197960	FBS-SUB-9-BU-2x4POL	
	GE	Plug Sub-D, IP65, 9-pin for Profibus DP	532216	FBS-SUB-9-GS-DP-B	
	GI	Socket 9-pin, Sub-D for Interbus nodes CPX and CPV	532218	FBS-SUB-9-BU-IB-B	
		Plug 9-pin, Sub-D for Interbus nodes CPX and CPV	532217	FBS-SUB-9-GS-IB-B	
GM	Plug 9-pin, Sub-D, for CC-Link CPX and CPV, IP65	532220	FBS-SUB-9-GS-2x4POL-B		
	GF	Bus connection 2x M12 adapter plug (B-coded, ReverseKey) for Profibus DP	533118	FBA-2-M12-5POL-RK	
	-	Socket M12x1, 5-pin, straight, for self-assembly of a connecting cable for FBA-2-M12-5POL-RK	1067905	NECU-M-B12G5-C2-PB	
	-	Plug M12x1, 5-pin, straight, for self-assembly of a connecting cable for FBA-2-M12-5POL-RK	1066354	NECU-M-S-B12G5-C2-PB	
	GL	Straight plug, Sub-D 9-pin, screw terminal 5-pin, IP20	197962	FBA-1-KL-5POL	

# Valve terminals type 10 CPV, Compact Performance, NPT

FESTO

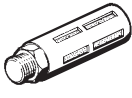
Accessories

Ordering data				
Designation			Part No.	Type
Operating voltage connection for Fieldbus Direct				
	Straight socket	M12, 4-pin, PG7, IP65	18497	FBSD-GD-7
		M12, 4-pin, PG9, IP65	18495	FBSD-GD-9
	Angled socket	M12, 4-pin, PG7, IP65	18524	FBSD-WD-7
		M12, 4-pin, PG9, IP65	18525	FBSD-WD-9
Blanking plug				
	Blanking plug		3843	B-M5
			174309	B-M7
			3568	B-1/8
			3569	B-1/4
			3570	B-3/8
			3571	B-1/2
Push-in fitting				
	Push-in fitting		183742	QS-1/8-5/16-I-U-M
			183744	QS-1/4-3/8-I-U-M
			183746	QS-3/8-3/8-I-U-M
			130591	QSM-M5-1/4-I-U-M
			183740	QSM-M7-1/4-I-U-M
Silencer				
	Silencer		4645	U-M5
			6841	U-1/8-B
			6842	U-1/4-B
			6843	U-3/8-B
			6844	U-1/2-B
			161418	UC-M7
Manual				
	CPV Pneumatics Manual	German	165100	P.BE-CPV-DE
		English	165200	P.BE-CPV-EN
		French	165130	P.BE-CPV-FR
		Italian	165160	P.BE-CPV-IT
		Spanish	165230	P.BE-CPV-ES
		Swedish	165260	P.BE-CPV-SV