

Modular electrical peripherals, for type 03/04

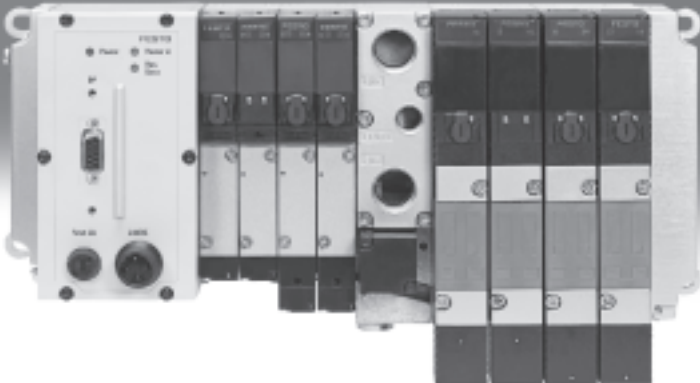

Modular electrical peripherals, for type 03/04

Key features

FESTO



Innovative

- First modular valve terminal on the market with modular electrical peripherals
- Standardised from the individual midi valve up to multi-pin and fieldbus connections
- First programmable valve terminal with integrated controller
- Digital I/O modules, either PNP switching
- Analogue I/O in the field for short lines
- Special modules for control desks
- Interfaces for subordinate, decentralised installation systems

Modular

- Modular system offering a range of configuration options
- Expandable up to 26 solenoid coils
- Conversions and extensions are possible at any time
- Connection blocks can be extended using 3 screws M4x14
- Modular electrical peripherals with digital and analogue I/Os
- High pressure range

Reliable

- Sturdy and durable metal components
 - I/O modules
 - Connection technology
 - Valves
 - Connection blocks
- Fast troubleshooting thanks to LEDs on the valves and I/O modules
- Diagnosis using fieldbus
- Pre-assembled cables for all I/O modules
- Reliability of service through replaceable valves and modules

Easy to assemble

- Ready to install unit, already assembled and tested
- Lower costs for selection, ordering, assembly and commissioning
- Secure wall mounting or via H-rail

Modular electrical peripherals, for type 03/04

Key features

Modular electrical peripherals for valve terminal type 03/04

Modular electrical peripherals provide the required control technology for type 03 (MIDI/MAXI) and type 04 (ISO) valve terminals. Together these components form the most comprehensive system range in intelligent pneumatics and also offer the advantage of a sturdy metal design.

As well as incorporating protection class IP65, the system also provides benefits through the sturdy design of its modules and connections. Individual modules are enclosed in metal housings with push-in fittings, and are made primarily of steel. The connections between the modules are protected by special seals and each connection point is secured using 3 robust M4x14 DIN 912 screws.

The main industrial fieldbuses are used for networking and control.

Directly integrated programmable controllers (PLC) with fieldbus interface from Festo can also be used for actuation.

The module also offers various actuation and connection options for machine control.

Ongoing further development and a worldwide service and consultation network round off the performance spectrum for this system.

 Note
Use the menu-driven online configurator for modular electrical peripherals type 03/04 and valve terminal in the electronic catalogue on www.festo.com.

Type 03 with fieldbus connection

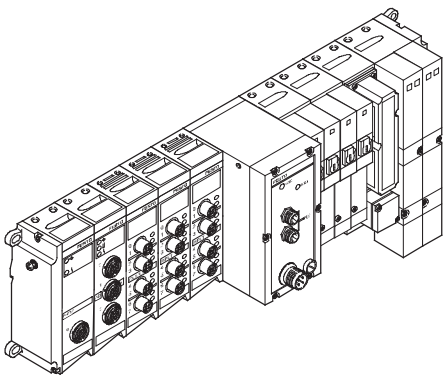

Type 03 with integrated programmable PLC

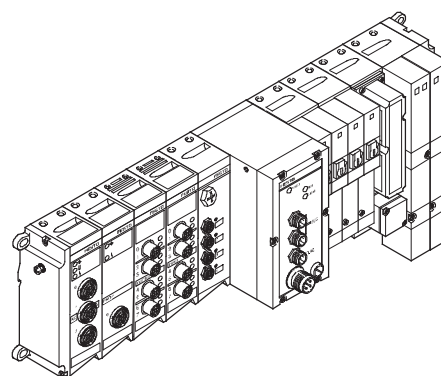

Type 04 with fieldbus connection

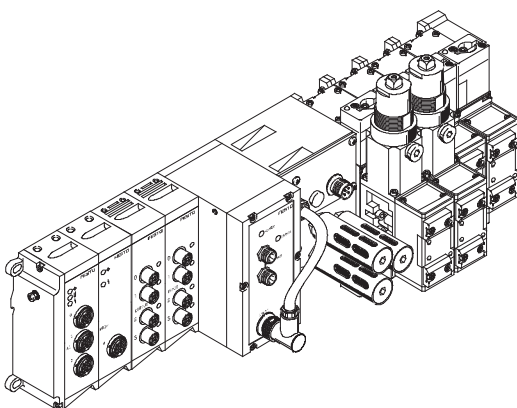

Ordering

Modular electrical peripherals type 03/04 and valve terminal are fully assembled according to your order specifications and individually tested.

The finished valve terminal consists of the electrical peripherals including the required actuator and the selected components of the MIDI/MAXI or ISO modules.

Modular electrical peripherals type 03/04 with valve terminal are ordered using two separate order codes. One order code defines the modular electrical peripherals type 03/04, while the other specifies the pneumatic components of the valve terminal.

Modular electrical peripherals type 03/04 can naturally also be configured without a valve terminal as a remote I/O and can be used on a fieldbus or with an integrated controller. For this order, you only require the order code for the electrical peripherals.

The order lists for the modular electrical peripherals type 03/04 can be found in this chapter. For information on how to order the pneumatic components see:

- ➔ Internet: type 03 midi maxi (valve terminal type 03)
- ➔ Internet: type 04 midi maxi (valve terminal type 04)

Modular electrical peripherals, for type 03/04

Key features – General

FESTO

Performance characteristics

Control block, fieldbus connection, multi-pin connection

Optimising and extending applications:

- Modules for installation-saving connection using sturdy Sub-D plugs in IP65
- Low-cost connections to input/output stations and control units
- CP modules for connecting decentralised CPV and CPA valve terminals
- Extensions and supplements can be added at any time

Easy mounting:

- On H-rail
- On mounting surface
- With covers in welding environments

Simple servicing and maintenance:

- LED display
- Manual override
- Clip-on inscription labels

Convenient diagnosis via fieldbus connection and integrated PLC:

- Status bits
- Diagnostic bits
- Integrated self-test

Input/output modules

Flexible for control systems thanks to an extensive range of connection nodes:

- Multi-pin connection
- Fieldbus connection

Stand-alone solutions with integrated PLC (control block).

Electrical digital inputs/outputs:

- Max. 12 modules in conjunction with suitable nodes
- Inputs for 24 V DC sensors, PNP
- Outputs for small-load power consumers 24 V DC

Proportional pneumatics:

- Analogue modules optimised for proportional valves, e.g. for Festo MPYE
- To detect, control/regulate universal variables (4 ... 20 mA or 0 ... 10 V DC) within the process – locally to IP65

Modular electrical peripherals, for type 03/04

Key features – General

Types of pneumatic valve terminals supported

Type 03 – MIDI/MAXI valve terminals

Type 04 – ISO valve terminals

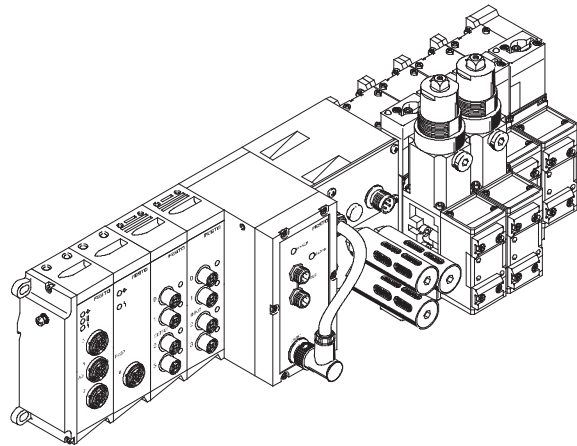
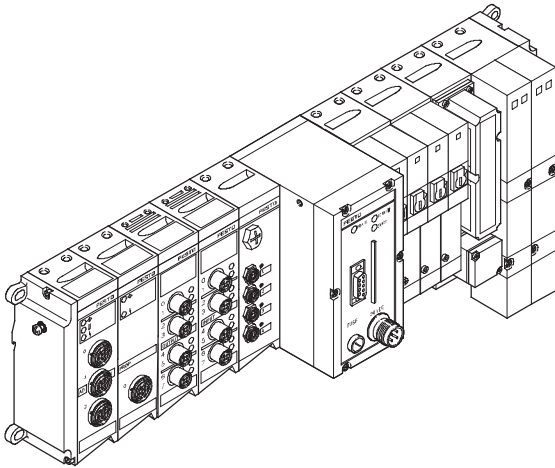

General functions of the bus nodes and control blocks

A bus node or control block is at the heart of the modular electrical peripheral system. They manage the communication connection to higher-order controllers and master interfaces and a PLC program with a full range of additional functions is executed directly in the control block. The power supply for the I/O modules and the sensors connected to them is provided by means of the bus node or control block, as is the load supply for the solenoid coils and the electronic outputs.

System monitoring and diagnosis are further important functions of the bus node or control block. The diagnostics are composed of three elements:

- Device-specific information displayed directly on the bus node or control block by means of LEDs.
- Device-specific status bits that are transferred to the control program via the network.
- Protocol-specific diagnoses.

The bus nodes or control blocks collect the most important diagnostic data in the status bits and transfer it to the higher-order controller as logical inputs.

Suitable further processing functions in the control program provide helpful information on the status of the power supply, short circuits and overload (with some of this information relating to specific modules or channels). Further protocol and node-specific diagnostic services are described in conjunction with the individual I/O modules, bus nodes and control blocks.

The control blocks are original controllers from Festo and are identical to systems with the original design in terms of both their function and their system and integration compatibility.

Modular electrical peripherals, for type 03/04

Key features – Electrical components

Supply voltage

The entire power supply for the system and the sensors and actuators connected to it is provided via an M18 mains plug.

The power supply for the electrical peripherals type 03 and 04 is split in two.

Pin 1 of the mains plug provides the sensor supply for the input modules and supplies the internal electronics of the individual modules.

The sensor supply is protected separately from the electronics supply in the node by means of a 2 A fuse. We recommend that pin 1 be additionally protected against short circuit/overload by means of a 3.15 A external fuse.

Pin 2 of the mains plug provides the load supply for solenoid coil actuation and the electrical 24 V DC outputs.

The load supply must be externally protected against short circuit and overload by means of a 10 A strong fuse.

The load voltage of the valves and electrical outputs can be disconnected separately. The common 0 V line is connected to pin 3. Pin 4 serves as an earth terminal.

With valve terminals of the type 04, the solenoid coils are protected by an additional fuse.

Example of circuit

Connection of a common 24 V DC power supply and the protective earth (type 03 used in the example)

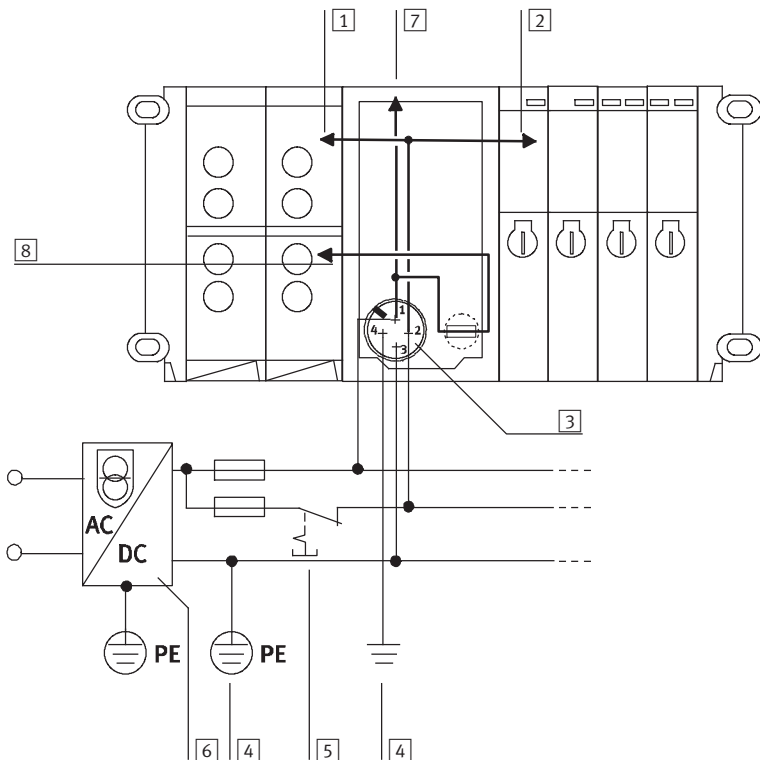

- 1 Electrical outputs (externally fused)
- 2 Valves
- 3 Voltage supply connection for node type 03
- 4 Potential equalisation
- 5 Load voltage, can be disconnected separately
- 6 Power supply unit (e.g. central voltage supply)
- 7 24 V DC electronics
- 8 Electrical inputs/sensors

Pin allocation

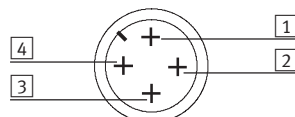
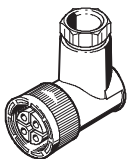

- 1 24 V DC supply for electronics and inputs
- 2 24 V DC load supply for valves
- 3 0 V
- 4 Earth terminal

Modular electrical peripherals, for type 03/04

Key features – Diagnosis

General system diagnosis		
Diagnostic information	Description	Function
Short circuit/overload at output	Output has short-circuited or become overloaded	Monitors the electrical outputs of the output modules
$V_{\text{Valves}} < 21.6 \text{ V DC}$	Load voltage at pin 2 (valves and outputs) of the operating voltage connection $< 21.6 \text{ V DC}$	Monitors the tolerance of the load voltage for valves and electrical outputs
$V_{\text{Outputs}} < 10 \text{ V DC}$	Load voltage at pin 2 (valves and outputs) of the operating voltage connection $< 10 \text{ V DC}$	Monitors the load voltage for valves and electrical outputs (no voltage, e.g. EMERGENCY-STOP)
$V_{\text{Sensor}} < 10 \text{ V DC}$	Operating voltage at pin 1 (electronics and inputs) of the operating voltage connection $< 10 \text{ V DC}$	Monitors the operating voltage for inputs (sensors). Indicates whether an internal fuse has tripped, either the fuse in the node or at least an electronic fuse in the input module ¹⁾ .

1) An electronic fuse for input modules has been available since February 1999.

Modular electrical peripherals, for type 03/04

Key features – I/O addressing

General guidelines on I/O addressing

A maximum of 12 electrical modules can be assembled. Note, however, that some modules occupy 2 or even 3 module positions, in which case the maximum number of modules that can be assembled is reduced.

All 12 module positions can generally be used as inputs or outputs, however there are various fieldbus-specific restrictions that are documented in the node description.

The number and type of inputs/outputs, and hence input/output modules, supported by the network also depends on the fieldbus node used. The number of solenoid coils is restricted to 26 and is included in the address space of the digital outputs.

Each sub-base for single solenoid valves occupies 2 outputs, and each sub-base for double solenoid valves occupies 4 outputs. Within the output addresses, the valve solenoids are counted in ascending order from left to right starting from the node. In the case of double solenoid valves, coil 14 comes before coil 12 in the counting mode.

The address space of the valves is always rounded up to a value divisible by 4.

The solenoid coils are followed by the general outputs in the address space. The individual outputs in the output modules are listed in the address space in ascending order, from top to bottom and the modules are listed from right to left starting from the node (see diagram).

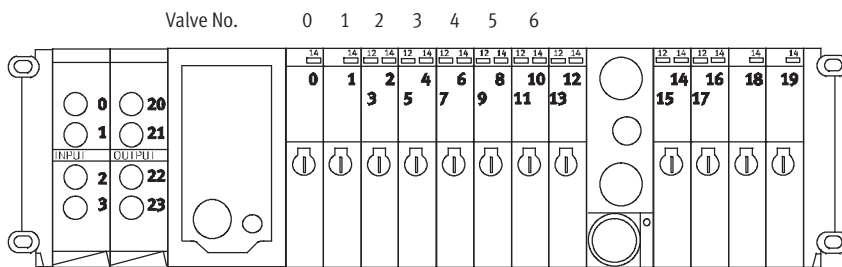

Test method for activation of the solenoid coils

The fieldbus nodes generally contain two different test sequences that activate the solenoid coils independently of any fieldbus combination or higher-order controller so that the function of the assembled valves can be verified.

The solenoid coils will be activated in parallel or serial mode depending on the test sequence selected, with each coil individually activated with a constant switching frequency in a predefined order.

Modular electrical peripherals, for type 03/04

Peripherals overview – Fieldbus systems

FESTO

Fieldbus systems, programmable terminal groups

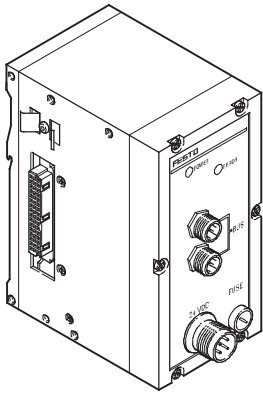

FESTO

MOELLER 

ABB

 **Allen-Bradley**



SIEMENS



ASA

Fieldbus variations:

Of the more than 20 different fieldbus systems (protocols) available in the market, some have emerged as the most important variants. Festo supports these by means of various fieldbus nodes (FBxx) on its valve terminals. Fieldbus systems require a powerful, central PLC and a master interface adapted to that particular fieldbus.

Fieldbus systems are generally used when several devices with many inputs/outputs, complex functions or high communication levels must be controlled. In this case, the advantages of simple cabling, easy diagnosis and maintenance outweigh the extra outlay for a fieldbus master interface and the necessary know-how.

Festo fieldbus:

A fieldbus developed by Festo with simple prompting, supported by the control systems in the FPC, SF and IPC series (Festo FB5).

Interbus, Interbus-FOC:

An open fieldbus standard, originally developed by Phoenix Contact and now in worldwide use. Important installation accessories such as bus plugs must be obtained from Phoenix or its partners (Festo FB6). Festo FB21 is required for Interbus-FOC, the Interbus variant "Rugged Line" with fibre optic cable.

Profibus DP:

An open fieldbus standard, originally developed by Siemens and in worldwide use (Festo FB13 for 12 MBd).

DeviceNet:

Open fieldbus standard based on the CAN technology originally developed for the automotive sector. DeviceNet was originally developed by Rockwell (Allen Bradley) and is now an open standard.

ASA (FIPIO):

Fieldbus used mainly in France (Festo FB16).

Modular electrical peripherals, for type 03/04

Peripherals overview – Control blocks

FESTO

Control blocks

Integrated controllers in the Festo valve terminals permit the construction of stand-alone control units to IP65 – without control cabinets.

Using the slave operation mode, these valve terminals can be used for intelligent pre-processing and are therefore ideal modules for designing decentralised intelligence.

With the master operation mode, terminal groups can be designed with many options and functions, which can autonomously control a medium sized machine/system.

Control block variants

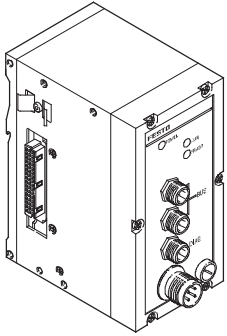

Integrated Festo PLC

A high performance miniature control system from Festo has been integrated into the SF3 valve terminal node. This provides stand-alone control of up to 128 inputs and 128 outputs.

With the Festo fieldbus, additional I/O and expanded functions can be installed and controlled.

The control block SF3 can be operated as required as a stand-alone operation, a fieldbus slave or master (with up to 31 fieldbus slaves and up to 1048 inputs and outputs).

Modular electrical peripherals, for type 03/04

Peripherals overview – Bus nodes

Equipping with bus node

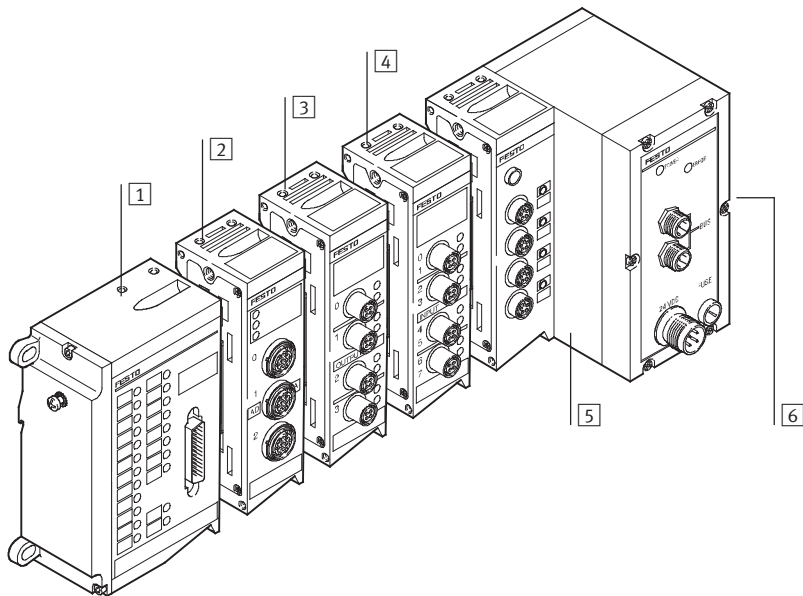

- 1 Input/output module
- 2 Analogue stage
- 3 Output module
- 4 Input module
- 5 Bus node
- 6 Connection side for pneumatics

Modular electrical peripherals for type 03/04 can be equipped with bus node. In addition to controlling the valves and electrical outputs, corresponding sensor feedback can be recorded at the electrical peripherals and transmitted via the fieldbus to the control cabinet.

The following applies to bus nodes:

- Max. 26 valve solenoid coils
- Number of inputs dependent on fieldbus type
- Number of electrical outputs dependent on fieldbus type and number of pneumatic valves
- Status bits for program controlled diagnosis occupy 4 input bits
 - Undervoltage of valves
 - Undervoltage of sensors
 - Short circuit at outputs
- I/O allocation, self-configuration
- Subsequent addition of input or output modules moves the addressing (I/O allocation) forwards
- I/O allocation of inputs and outputs independent from each other
- 4-fold and 8-fold input modules connect to the next Half-Byte (nibble)
- Electrical outputs connect to the next Half-Byte (nibble) on the valves.

Counting mode:
Valves from left to right, then from the next Nibble electrical outputs from right to left







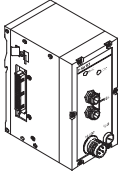

- Max. 12 modules are permitted on the left (electrical) side

 Type discontinued
Available up until 2012

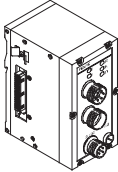
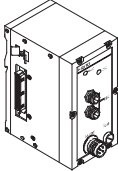
FESTO

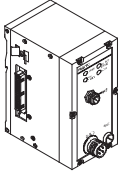
Modular electrical peripherals, for type 03/04

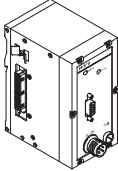
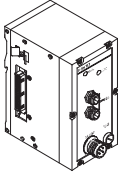
Peripherals overview – Bus nodes

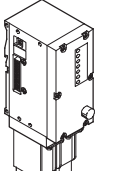
Fieldbus node							
View	Code	Type	Fieldbus protocol	Suitable for		→ Page/Internet	
				I/O	Analogue		
	FB5	 IFB5-03	Festo fieldbus, ABB (CS31), Moeller SUCONET K	■ 60/64	-	20	
	FB6	IFB6-03	Interbus	■ 60/64	■	24	
	FB8	 IFB8-03	Allen Bradley (1771 RIO)	■ 60/64	-	28	
	F11	 IFB11-03	DeviceNet, Phillips DIOS, SELECAN	■ 60/64	■	32	
	F13	IFB13-03	Profibus DP, 12 MBd	■ 92/74	■	36	
	F16	 IFB16-03	ASA (FIPIO)	■ 60/64	-	40	
	F21	IFB21-03	Interbus-FOC “Rugged Line”	■ 92/96	■	44	

Modular electrical peripherals, for type 03/04

Peripherals overview – Bus nodes

Overview – Address space for bus nodes							
	Bus protocol	Max. total		Max. digital		Max. analogue	
		Inputs	Outputs	Inputs	Outputs	Inputs	Outputs
IFB5-03	Festo fieldbus, ABB (CS31), Moeller SUCONET K	60 bit	64 bit	60 DI	64 DO	–	–
IFB6-03	Interbus	60 bit	64 bit	60 DI	60 DO	8 AI	8 AO
IFB8-03	AB 1771 RIO	60 bit	64 bit	60 DI	64 DO	–	–
IFB11-03	DeviceNet	60 bit	64 bit	60 DI	64 DO	8 AI	8 AO
IFB13-03	Profibus DP	92 bit	74 bit	92 DI	74 DO	12 AI/AO	–
IFB16-03	ASA (FIPIO)	60 bit	64 bit	60 DI	64 DO	–	–
IFB21-03	Interbus-FOC	92 bit	74 bit	92 DI	74 DO	8 AI	8 AO

DI = Digital inputs (1 bit)

DO = Digital outputs (1 bit)

AI = Analogue inputs (16 bit)

AO = Analogue outputs (16 bit)

- 1 - Type discontinued
Available up until 2012

FESTO

Modular electrical peripherals, for type 03/04

Peripherals overview – Control block

Equipping with control block

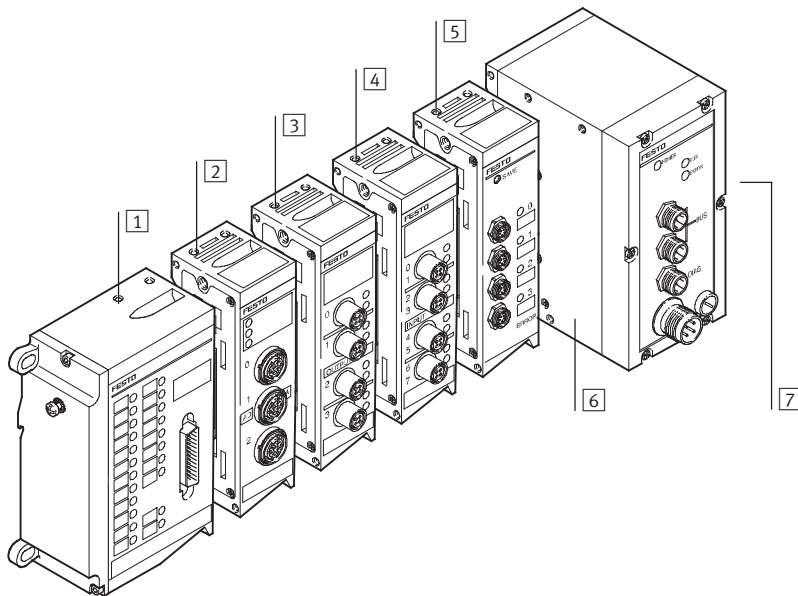

- 1 Input/output module
- 2 Analogue stage
- 3 Output module
- 4 Input module
- 5 Electrical interface for CP interface
- 6 Control block
- 7 Connection side for pneumatics

Modular electrical peripherals for type 03/04 can be equipped with various control blocks. In addition to controlling the valves and outputs, corresponding sensor feedback can be recorded at the electrical peripherals and processed autonomously with the integrated PLC. Additional expansion and networking is possible via the fieldbus.

The following applies to control blocks:

- Max. 26 valve solenoid coils
- Max. 96 local inputs
- Max. 48 local outputs
- Max. 48 analogue channels (SF3)
- CP interface for 64 inputs and 64 outputs (decentralised 2 ... 10 m per string)
- I/O allocation of inputs and outputs independent from each other
- I/O allocation, self-configuration
- 4-fold and 8-fold input modules connect to the next Half-Byte (nibble)
- Electrical outputs connect to the next Half-Byte (nibble) on the valves.
Counting mode: Valves from left to right, then from the next Nibble electrical outputs from right to left
- Max. 12 modules are permitted on the left (electrical) side
- Subsequent addition of input or output modules or valves moves the addressing (I/O allocation) forwards

Modular electrical peripherals, for type 03/04

Peripherals overview – Control block

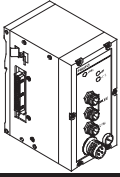
Control block							
View	Code	Type	Control block	Suitable for			→ Page/Internet
				I/O	PROP	CP	
	SF3	ISF3-03	SF3 with Festo fieldbus	■ 128/128	■	■	48

- Programming the control block
ISF3-03 with FST200 in Ladder
Diagram or Statement List

Modular electrical peripherals, for type 03/04

Peripherals overview

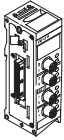
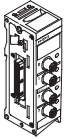
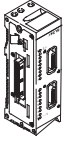
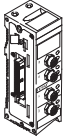
Electronics modules with multi-pin node/bus node and control block combinations								
Electronics modules	Type	Multi-pin node			Bus node			
		MP1 ¹⁾	MP2 ¹⁾	MP4 ¹⁾	IFB5-03	IFB6-03	IFB8-03	IFB11-03
Input modules								
	VIGE-03-FB-8-5POL Input module for standard inputs PNP, 8-fold, 5-pin	-	-	-	■	■	■	■
	VIGE-03-FB-8,1-5POL Input module for high-speed inputs (1 ms) PNP, 8-fold, 5-pin	-	-	-	■	■	■	■
	VIGE-03-FB-8-5POL-S Input module for standard inputs PNP, 8-fold, 5-pin, with separate fuse	-	-	-	■	■	■	■
	VIGE-03-MP-8 Input module for multi-pin connection 8-fold, 4-pin	-	■	-	-	-	-	-
	VIGE-03-FB-4-5POL Input module for standard inputs PNP, 4-fold, 5-pin	-	-	-	■	■	■	■
	VIGE-03-MP-4 Input module for multi-pin connection 4-fold, 4-pin	-	■	-	-	-	-	-
	VIGE-03-FB-16-SUBD-S Input module with Sub-D plug PNP, 16-fold, 2x 15-pin socket	-	-	-	■	■	■	■
Output modules								
	VIGA-03-FB-4-5POL Output module for standard outputs PNP, 4-fold, 5-pin	-	-	-	■	■	■	■

1) Not for valve terminal type 04

Modular electrical peripherals, for type 03/04

Peripherals overview

Electronics modules with multi-pin node/bus node and control block combinations					
Type	Bus node			Control block	→ Page/Internet
	IFB13-03	IFB16-03	IFB21-03 ¹⁾	ISF3-03 ¹⁾	
Input modules					
VIGE-03-FB-8-5POL Input module for standard inputs PNP, 8-fold, 5-pin	■	■	■	■	54
VIGE-03-FB-8,1-5POL Input module for high-speed inputs (1 ms) PNP, 8-fold, 5-pin	■	■	■	■	54
VIGE-03-FB-8-5POL-S Input module for standard inputs PNP, 8-fold, 5-pin, with separate fuse	■	■	■	■	54
VIGE-03-MP-8 Input module for multi-pin connection 8-fold, 4-pin	-	-	-	-	type 03
VIGE-03-FB-4-5POL Input module for standard inputs PNP, 4-fold, 5-pin	■	■	■	■	54
VIGE-03-MP-4 Input module for multi-pin connection 4-fold, 4-pin	-	-	-	-	type 03
VIGE-03-FB-16-SUBD-S Input module with Sub-D plug PNP, 16-fold, 2x 15-pin socket	■	■	■	■	58
Output modules					
VIGA-03-FB-4-5POL Output module for standard outputs PNP, 4-fold, 5-pin	■	■	■	■	61



1) Not for valve terminal type 04

 Type discontinued
Available up until 2012

Modular electrical peripherals, for type 03/04

Peripherals overview

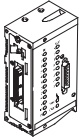
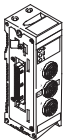
FESTO

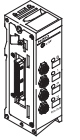
Electronics modules with multi-pin node/bus node and control block combinations								
Electronics modules	Type	Multi-pin node			Bus node			
		MP1 ¹⁾	MP2 ¹⁾	MP4 ¹⁾	IFB5-03	IFB6-03	IFB8-03	IFB11-03
Input/output modules								
	VIEA-03-FB-12E-8A-SUBD Input/output module PNP, 12I/8O, Sub-D	-	-	-	■	■	■	■
Analogue stage								
	VIAU-03-FB-U Analogue stage 3I/1O, 0 ... 10 V DC	-	-	-	-	■	-	■
	VIAU-03-FB-I Analogue stage 3I/1O, 4 ... 20 mA	-	-	-	-	■	-	■
	VIAP-03-FB Analogue stage for proportional valve 1I/1O	-	-	-	-	■	-	■
Electrical interface								
	VIGCP-03-FB Electrical interface to a CP installation system	-	-	-	-	-	■	-

1) Not for valve terminal type 04

Modular electrical peripherals, for type 03/04

Peripherals overview

Electronics modules with multi-pin node/bus node and control block combinations					
Type	Bus node			Control block	→ Page/Internet
	IFB13-03	IFB16-03	IFB21-03 ¹⁾	ISF3-03 ¹⁾	
Input/output modules					
VIEA-03-FB-12E-8A-SUBD Input/output module PNP, 12I/8O, Sub-D	■	■	■	■	63
Analogue stage					
VIAU-03-FB-U Analogue stage 3I/1O, 0 ... 10 V DC	■	-	■	■	65
VIAU-03-FB-I Analogue stage 3I/1O, 4 ... 20 mA	■	-	■	■	65
VIAP-03-FB Analogue stage for proportional valve 1I/1O	■	-	■	■	65
Electrical interface					
VIGCP-03-FB Electrical interface to a CP installation system	-	-	-	■	69

1) Not for valve terminal type 04

- 1 - Type discontinued
Available up until 2012

Modular electrical peripherals, for type 03/04

Technical data – Bus node IFB5-03

FESTO

FESTO

MOELLER 

ABB

This bus node handles communication between the modular electrical peripherals and a higher-order master.

For the modular electrical peripherals, this module provides the separate electrical system supply for

- the electronics modules and sensor supply, and
- the load current of the electrical outputs and valves.

The bus node supports three different company-specific fieldbus protocols, based on a floating RS485 connection.

The required protocol is selected by means of switch settings.

- Festo fieldbus
- ABB CS31
- Moeller SUCONET K



Application

Bus connection

The bus connection on the IFB5-03 is established by means of two 4-pin M12 plugs with four connections. The two plugs are connected internally, so that either a branch line installation can be performed with one cable,

or 2 cables can be routed to the bus node, connected to the two plugs and looped through.

Implementation

The IFB5-03 supports the digital input and output modules and the solenoid coils. It does not support analogue modules.

It can service a total of 64 digital outputs, of which max. 26 can include solenoid coils, and 60 digital inputs.

 Note

Please observe the general guidelines on I/O addressing when assigning the outputs.

Modular electrical peripherals, for type 03/04

Technical data – Bus node IFB5-03

General technical data			
Type	IFB5-03		
Combination with analogue modules	No		
Baud rates	Festo fieldbus	[kbps]	Set using HW switch • 31.25 • 62.50 • 187.50 • 375
	ABB CS31	[kbps]	187.50
	Moeller SUCONET K	[kbps]	Baud rate set automatically • 187.50 • 375
Addressing range	Festo fieldbus		1 ... 99
	ABB CS31		1 ... 60
	Moeller SUCONET K		1 ... 99
Type of communication	Festo fieldbus		Cyclic polling
	ABB CS31		116, 016 or I/O16
	Moeller SUCONET K		Up to 32 I/O: SIS-K-06/07 Up to 64 I/O: SIS-K-10/10
Max. no. of solenoid coils	26		
Max. no. of outputs incl. solenoid coils	64		
Max. no. of inputs	60		
LED diagnostic displays	Power	Operating status	
	Bus	Error status	
Device-specific diagnostics transmitted to the controller	<ul style="list-style-type: none"> • Short circuit/overload, outputs • Undervoltage of valves • Undervoltage of outputs • Undervoltage of sensor supply 		
Operating voltage	Nominal value	[V DC]	24 polarity-safe
	Permissible range	[V DC]	18 ... 30
	Power failure buffering	[ms]	20
Current consumption	[mA] 200 + total current consumption of inputs, internal		
Certification	CE		
Protection class to EN 60529	IP65		
Temperature range	Operation	[°C]	-5 ... +50
	Storage	[°C]	-20 ... +70
Materials	Housing	Die-cast aluminium	
	Cover	Polyamide	
Dimensions (HxWxD)	[mm]	132 x 85 x 125	
Grid dimension	[mm]	72	
Weight	[g]	1000	

- 1 - Type discontinued
Available up until 2012

Modular electrical peripherals, for type 03/04

Technical data – Bus node IFB5-03

Connection and display components

The following connection and display components can be found on the bus node cover:

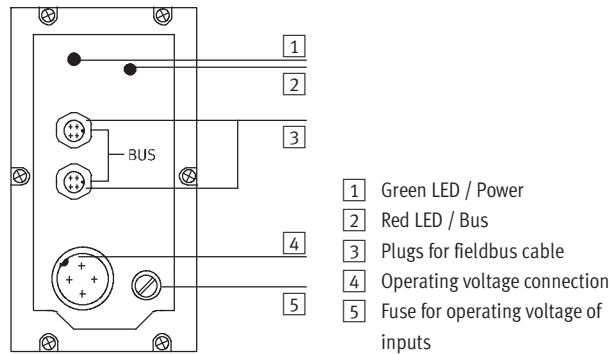



Pin allocation for fieldbus interface

Terminal allocation

Terminal allocation	Pin	Signal
	1	S+/Bus2
	2	n.c.
	3	S-/Bus2
	4	Screen/shield
	1	S+/Bus1
	2	n.c.
	3	S-/Bus1
	4	Screen/shield
3	Internal network	
4	Housing/node	

Modular electrical peripherals, for type 03/04

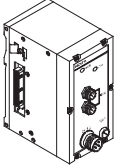
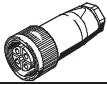
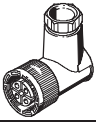
Accessories – Bus node IFB5-03

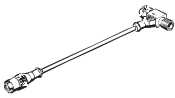
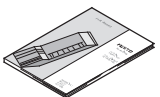
Ordering data			
Designation		Part No.	Type
Bus node			
	<ul style="list-style-type: none"> Festo Feldbus ABB CS31 Moeller SUCONET K 	18735	IFB5-03
Power supply			
	Plug socket, straight, M18x1, 4-pin	for 1.5 mm ²	18493 NTSD-GD-9
		for 2.5 mm ²	18526 NTSD-GD-13,5
	Plug socket, angled, M18x1, 4-pin	for 1.5 mm ²	18527 NTSD-WD-9
		for 2.5 mm ²	533119 NTSD-WD-11
Fieldbus connection			
	Bus connection, straight, M12, 4-pin	Pg7	18497 FBSD-GD-7
		Pg9	18495 FBSD-GD-9
		Pg13.5	18496 FBSD-GD-13,5
	Bus connection, angled, M12, 4-pin	Pg7	18524 FBSD-WD-7
		Pg9	18525 FBSD-WD-9
	T-adapter, M12	for Festo fieldbus	18498 FB-TA
	T-adapter for fieldbus, with an open ended cable		18499 FB-TA1
User documentation			
	User documentation – Bus node IFB5-03	German	152755 P.BE-VIFB5-03-DE
		English	152765 P.BE-VIFB5-03/05-EN

Modular electrical peripherals, for type 03/04

Technical data – Bus node IFB6-03

FESTO



This bus node handles communication between the modular electrical peripherals and a higher-order master.

For the modular electrical peripherals, this module provides the separate electrical system supply for

- the electronics modules and sensor supply, and
- the load current of the electrical outputs and valves.



Application

Bus connection

The bus connection is established via two 9-pin M23 connections with a typical Interbus pin allocation.

The plug and socket are labelled with Remote IN and Remote OUT in accordance with the definition for the Interbus remote bus.

Both bus cables are always routed to the bus node and looped through in accordance with the ring structure of the Interbus.

Implementation

The IFB6-03 supports the digital input and output modules and the solenoid coils. It also supports analogue modules. It can service a total of 64 digital outputs, of which max. 26 can include

solenoid coils, and 60 digital inputs. The FB6 supports max. 8 analogue input channels and 8 analogue output channels. The analogue channels are operated

in multiplex mode and occupy 16 process data bits. The number of possible digital inputs and outputs is reduced by 16 bits when analogue modules are used.



Note

Please observe the general guidelines on I/O addressing when assigning the outputs.

Modular electrical peripherals, for type 03/04

Technical data – Bus node IFB6-03

General technical data			
Type		IFB6-03	
Combination with analogue modules		Yes	
Baud rates	[kbps]	500	
ID code		1, 2 or 3 depending on expansion	
No. of process data bits		16, 32, 48 or 64 depending on expansion	
PCP channel		No	
Configuration support		<ul style="list-style-type: none"> • Icon file for CMD software • Station description file with CMD software 	
Max. no. of solenoid coils		26	
Max. no. of outputs incl. solenoid coils		64	
Max. no. of inputs		60	
LED diagnostic displays	UL	Operating voltage of internal electronics	
	UI	Operating voltage of Interbus interface	
	RC	Remotebus check	
	BA	Bus active	
	RD	Remotebus disable	
Device-specific diagnostics transmitted to the controller		<ul style="list-style-type: none"> • Short circuit/overload, outputs • Undervoltage of valves • Undervoltage of outputs • Undervoltage of sensor supply • Error during analogue processing 	
Operating voltage	Nominal value	[V DC]	24 polarity-safe
	Permissible range	[V DC]	18 ... 30
	Power failure buffering	[ms]	20
Current consumption		[mA]	200 + total current consumption of inputs, internal
Protection class to EN 60529		IP65	
Temperature range	Operation	[°C]	-5 ... +50
	Storage	[°C]	-20 ... +70
Materials	Housing	Die-cast aluminium	
	Cover	Polyamide	
Dimensions (HxWxD)		[mm]	132 x 85 x 125
Grid dimension		[mm]	72
Weight		[g]	1000

Modular electrical peripherals, for type 03/04

Technical data – Bus node IFB6-03

Connection and display components

The following connection and display components can be found on the bus node cover:

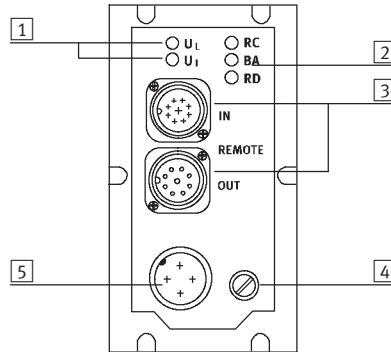

- 1 Power supply indicator
- 2 Fieldbus status indicator
- 3 INTERBUS interface
- 4 Fuse for operating voltage of inputs
- 5 Operating voltage connection



Pin allocation for the INTERBUS interface, non-floating installation remote bus

Terminal allocation	Pin ¹⁾	Signal	Designation
Incoming			
Plug view 	1	DO	Data out
	2	/DO	Data out inverse
	3	DI	Data in
	4	/DI	Data in inverse
	5	Ground	Reference conductor
	6	FE	Functional earthing
	7	+24 V DC	Installation remote bus supply
	8	+0 V	Installation remote bus supply
	Sleeve	Screen	Screening
	Outgoing		
Socket view 	1	DO	Data out
	2	/DO	Data out inverse
	3	DI	Data in
	4	/DI	Data in inverse
	5	Ground	Reference conductor
	6	FE	Functional earthing Installation remote bus
	7	+24 V DC	Installation remote bus supply
	8	+0 V	Installation remote bus supply
	9	RBST	Establish bridge to pin 5
	Sleeve	Screen	Screening

1) Pins not listed here must not be connected.

Modular electrical peripherals, for type 03/04

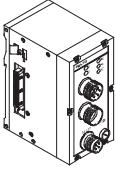
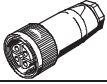
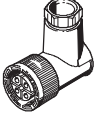
Accessories – Bus node IFB6-03

Ordering data			
Designation		Part No.	Type
Bus node			
	Interbus	18736	IFB6-03
Power supply			
	Plug socket, straight, M18x1, 4-pin	for 1.5 mm ²	18493 NTSD-GD-9
		for 2.5 mm ²	18526 NTSD-GD-13,5
	Plug socket, angled, M18x1, 4-pin	for 1.5 mm ²	18527 NTSD-WD-9
		for 2.5 mm ²	533119 NTSD-WD-11
User documentation			
	User documentation – Bus node IFB6-03	German	152756 P.BE-VIFB6-03-DE
		English	152766 P.BE-VIFB6-03-EN
		French	163926 P.BE-VIFB6-03-FR
		Spanish	163906 P.BE-VIFB6-03-ES
		Italian	165426 P.BE-VIFB6-03-IT
		Swedish	165456 P.BE-VIFB6-03-SV

- 1 - Type discontinued
Available up until 2012

Modular electrical peripherals, for type 03/04

Technical data – Bus node IFB8-03

FESTO



This bus node handles communication between the modular electrical peripherals and a higher-order master.

For the modular electrical peripherals, this module provides the separate electrical system supply for

- the electronics modules and sensor supply, and
- the load current of the electrical outputs and valves.

The bus node supports the 1771 Remote I/O fieldbus from Allen Bradley/Rockwell Automation.



Application

Bus connection

The FB8 bus node has 2 M12 plugs with 4 connections for connecting to the Remote interface.

The two plugs are connected internally, so that either a branch line installation can be performed with one

cable, or 2 cables can be routed to the bus node, connected to the two plugs and looped through.

Implementation

The IFB8-03 supports the digital input and output modules and the solenoid coils. It does not support analogue modules.

It can service a total of 64 digital outputs, of which max. 26 can include solenoid coils, and 60 digital inputs.

The CP interface module can be connected as an alternative if the CP installation system is used, however this mode of operation does not support the direct mounting of valves and input/output modules.



Note

Please observe the general guidelines on I/O addressing when assigning the outputs.

Modular electrical peripherals, for type 03/04

Technical data – Bus node IFB8-03

General technical data		
Type	IFB8-03	
Combination with analogue modules	No	
Baud rates	[kbps]	Set using HW switch <ul style="list-style-type: none"> • 57.6 • 115.2 • 230.4
Addressing range	The maximum rack number and I/O group depends on the controller connected. With PLC-3 up to rack no. 30 group 4/5.	
Emulated product	Remote Rack Quarter rack or half rack	
Configuration support	Automatic configuration as a quarter or half rack	
Max. no. of solenoid coils	26	
Max. no. of outputs incl. solenoid coils	64	
Max. no. of inputs	60	
LED diagnostic displays	Power	Operating status
	Bus	Error status
Device-specific diagnostics transmitted to the controller	<ul style="list-style-type: none"> • Short circuit/overload, outputs • Undervoltage of valves • Undervoltage of outputs • Undervoltage of sensor supply 	
Operating voltage	Nominal value	[V DC] 24 polarity-safe
	Permissible range	[V DC] 18 ... 30
	Power failure buffering	[ms] 20
Current consumption	[mA]	200 + total current consumption of inputs, internal
Protection class to EN 60529	IP65	
Temperature range	Operation	[°C] -5 ... +50
	Storage	[°C] -20 ... +70
Materials	Housing	Die-cast aluminium
	Cover	Polyamide
Dimensions (HxWxD)	[mm]	132 x 85 x 125
Grid dimension	[mm]	72
Weight	[g]	1000

- 1 - Type discontinued
Available up until 2012

Modular electrical peripherals, for type 03/04

Technical data – Bus node IFB8-03

FESTO

Connection and display components

The following connection and display components can be found on the bus node cover:

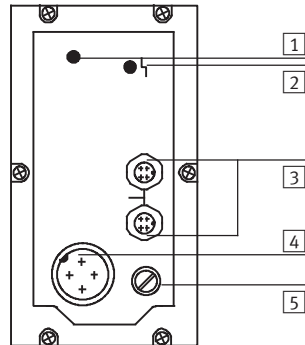



- 1 Red LED / Bus
- 2 Green LED / Power
- 3 RIO interface
- 4 Operating voltage connection
- 5 Fuse for operating voltage of inputs

Pin allocation for RIO interface

Terminal allocation	Pin	Signal
	1	Plug 1
	1	S+/Bus2
	2	n.c.
	3	S-/Bus2
	4	Screen/shield
	2	Plug 2
	1	S+/Bus1
	2	n.c.
3	S-/Bus21	
4	Screen/shield	
3	Internal network	
4	Housing/node	

Modular electrical peripherals, for type 03/04

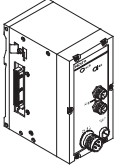
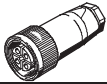
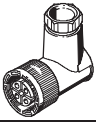
Accessories – Bus node IFB8-03

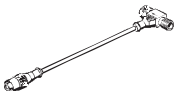
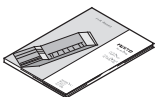
Ordering data			
Designation		Part No.	Type
Bus node			
	For the 1771 Remote I/O fieldbus from Allen Bradley/Rockwell Automation	18738	IFB8-03
Power supply			
	Plug socket, straight, M18x1, 4-pin	for 1.5 mm ²	18493 NTSD-GD-9
		for 2.5 mm ²	18526 NTSD-GD-13,5
	Plug socket, angled, M18x1, 4-pin	for 1.5 mm ²	18527 NTSD-WD-9
		for 2.5 mm ²	533119 NTSD-WD-11
Fieldbus connection			
	Bus connection, straight, M12, 4-pin	Pg7	18497 FBSD-GD-7
		Pg9	18495 FBSD-GD-9
		Pg13.5	18496 FBSD-GD-13,5
	Bus connection, angled, M12, 4-pin	Pg7	18524 FBSD-WD-7
		Pg9	18525 FBSD-WD-9
	T-adapter, M12	for Festo fieldbus	18498 FB-TA
	T-adapter for fieldbus, with an open ended cable		18499 FB-TA1
User documentation			
	User documentation – Bus node IFB8-03	German	152758 P.BE-VIFB8-03-DE
		English	152768 P.BE-VIFB8-03/05-EN

- 1 - Type discontinued
Available up until 2012

Modular electrical peripherals, for type 03/04

Technical data – Bus node IFB11-03

FESTO



This bus node handles communication between the modular electrical peripherals and a higher-order master.

For the modular electrical peripherals, this module provides the separate electrical system supply for

- the electronics modules and sensor supply, and
- the load current of the electrical outputs and valves.



Application

Bus connection

The DeviceNet connection is established via a 5-pin M12 plug with pins that corresponds to the specific mini connector.

A DeviceNet installation with a higher degree of protection is typically laid using main and branch lines that are connected via T-pieces.

Various manufacturers such as Turck, Lumberg and Rockwell offer finished cables and terminating resistors.

The terminating resistors are attached to the two outermost T-pieces. This installation technique keeps the bus closed while a bus station is being removed.

Implementation

The IFB11-03 supports the digital input and output modules, the solenoid coils and the analogue modules. It can service a total of 60 digital inputs and 64 digital outputs, of which

max. 26 can include solenoid coils. Together with the analogue modules, this bus node services max. 8 output and 8 input channels. 16 inputs and

16 outputs are always occupied if analogue modules are used, regardless of the number of analogue channels used.



Note

Please observe the general guidelines on I/O addressing when assigning the outputs.

Modular electrical peripherals, for type 03/04

Technical data – Bus node IFB11-03

General technical data			
Type		IFB11-03	
Combination with analogue modules		Yes	
Baud rates	[kbps]	Set using HW switch • 125 • 250 • 500	
Addressing range		Set using 2 rotary switches 0 ... 63	
Product type		Pneumatic valve (25 dec.)	
Product code		2282/35050	
Type of communication		Polling	
Configuration support		EDS file and graphics symbol	
Max. no. of solenoid coils		26	
Max. no. of outputs and solenoid coils		64	
Max. no. of inputs		60	
Max. no. of analogue channels		8 output channels 8 input channels	
LED diagnostic displays	Power	Operating voltage of electronics	
	Bus/Power	Operating voltage of bus	
	MOD/NET	Operating status	
	Error	Internal error	
Device-specific diagnostics via DeviceNet		<ul style="list-style-type: none"> • Short circuit/overload, outputs • Undervoltage of valves • Undervoltage of outputs • Undervoltage of sensor supply 	
Operating voltage	Nominal value	[V DC]	24 polarity-safe
	Permissible range	[V DC]	18 ... 30
	Power failure buffering	[ms]	20
Current consumption		[mA]	200 + total current consumption of inputs, internal
Protection class to EN 60529		IP65	
Temperature range	Operation	[°C]	-5 ... +50
	Storage/transport	[°C]	-20 ... +7
Materials	Housing	Die-cast aluminium	
	Cover	Polyamide	
Dimensions (HxWxD)		[mm]	132 x 85 x 125
Grid dimension		[mm]	72
Weight		[g]	1000

- 1 - Type discontinued
Available up until 2012

Modular electrical peripherals, for type 03/04

Technical data – Bus node IFB11-03

Connection and display components

The following connection and display components can be found on the bus node cover:

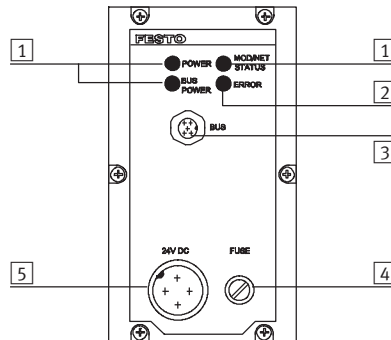



- 1 Green LEDs
- 2 Red LED
- 3 Plug for fieldbus cable
- 4 Fuse for operating voltage of inputs
- 5 Operating voltage connection

Pin allocation for fieldbus interface

Terminal allocation	Pin	Signal
	1	Screen
	2	+24 V DC bus
	3	GND Bus
	4	Data+
	5	Data-
2	Housing of the fieldbus connection module PE	
3	Internal screen connection in the valve terminal	

Modular electrical peripherals, for type 03/04

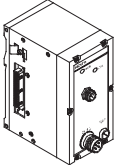
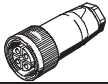
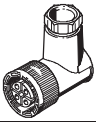
Accessories – Bus node IFB11-03

Ordering data			
Designation		Part No.	Type
Bus node			
	DeviceNet	18728	IFB11-03
Power supply			
	Plug socket, straight, M18x1, 4-pin	for 1.5 mm ²	18493 NTSD-GD-9
		for 2.5 mm ²	18526 NTSD-GD-13,5
	Plug socket, angled, M18x1, 4-pin	for 1.5 mm ²	18527 NTSD-WD-9
		for 2.5 mm ²	533119 NTSD-WD-11
Fieldbus connection			
	Bus connection, straight, Pg9, 5-pin	18324	FBSD-GD-9-5POL
User documentation			
	User documentation – Bus node IFB11-03	German	163951 P.BE-VIFB11-03-DE
		English	163956 P.BE-VIFB11-03-EN
		French	163931 P.BE-VIFB11-03-FR
		Italian	165431 P.BE-VIFB11-03-IT
		Swedish	165461 P.BE-VIFB11-03-SV

Modular electrical peripherals, for type 03/04

Technical data – Bus node IFB13-03

FESTO



Bus node for handling communication between the modular electrical peripherals and a higher-order master via Profibus DP.

For the modular electrical peripherals, this module provides the separate electrical system supply for

- the electronics modules and sensor supply, and
- the load current of the electrical outputs and valves.

The status of the voltage supplies and the bus communication is indicated via the LEDs Power, Power Valves and Bus Error.



Application

Bus connection

The bus connection is established via a 9-pin Sub-D socket with a typical Profibus allocation (to EN 50 170).

The bus connector plug (with protection class IP65 from Festo or IP20 from other manufacturers) facilitates the connection of an incoming and an outgoing bus cable.

An active bus terminal can be connected using the integrated DIL switch. The Sub-D interface is designed for the control of network components with a fibre optic cable connection.

-  - Note

A “Reverse Key” connection can be established via a 2x M12 adapter plug (B-coded).

Implementation

The IFB13-03 supports digital input and output modules and solenoid coils. Analogue modules can also be used.

- 74 digital outputs in total, of which

max. 26 solenoid coils.

- Max. 92 digital inputs for recording sensor signals.

The bus node supports max. 12 ana-

logue input/output channels. Analogue modules occupy a discrete address space, separate from the digital inputs and outputs.

-  - Note

Please observe the general guidelines on I/O addressing when assigning the outputs.

Modular electrical peripherals, for type 03/04

Technical data – Bus node IFB13-03

General technical data			
Type		IFB13-03	
Combination with analogue modules		Yes	
Baud rates		Automatic detection 9.6 kBaud ... 12 MBaud	
Addressing range		Set using 2 rotary switches and a DIL switch 1 ... 125	
Product family		4: Valves	
Ident. number		0xFB13	
Type of communication		Cyclic communication	
Configuration support		GSD file and bitmaps	
Max. no. of solenoid coils		26	
Max. no. of outputs and solenoid coils		74	
Max. no. of inputs		92	
Max. no. of analogue channels		12 input/output channels	
LED diagnostic displays	Power	Operating voltage of electronics	
	Power V	Operating voltage of valves and outputs	
	Bus Error	Communication error	
Device-specific diagnostics via Profibus DP		<ul style="list-style-type: none"> • Short circuit/overload, outputs (channel diagnostics) • Undervoltage of valves • Undervoltage of outputs • Undervoltage of sensor supply • Error during analogue processing 	
Additional functions		<ul style="list-style-type: none"> • Status/diagnostic bits in the process image of the inputs • Test routine for checking the valves and outputs without bus communication • Indication of the valve terminal configuration via Power V and Bus Error LEDs 	
Operating voltage	Nominal value	[V DC]	24 polarity-safe
	Permissible range	[V DC]	18 ... 30
	Power failure buffering	[ms]	20
Current consumption		[mA]	200 + total current consumption of inputs, internal
Protection class to EN 60529		IP65	
Temperature range	Operation	[°C]	-5 ... +50
	Storage/transport	[°C]	-20 ... +70
Materials	Housing	Die-cast aluminium	
	Cover	Polyamide	
Dimensions (HxWxD)		[mm]	132 x 85 x 125
Grid dimension		[mm]	72
Weight		[g]	1000

Modular electrical peripherals, for type 03/04

Technical data – Bus node IFB13-03

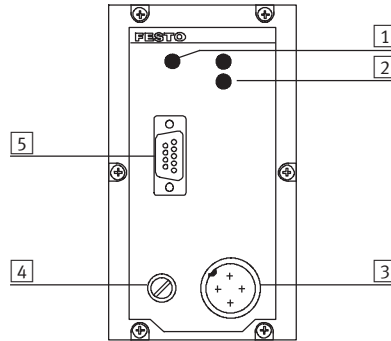

Connection and display components

The following connection and display components can be found on the bus node cover:



- 1 Green LED / Power
- 2 Red LED / Bus
- 3 Operating voltage connection
- 4 Fuse for operating voltage of inputs
- 5 Plug for fieldbus cable

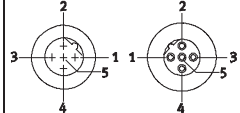

Pin allocation for Profibus DP interface

Terminal allocation	Pin	Signal	Designation
Plug, Sub-D			
	Viewed from the socket side		
	1	n.c.	Not connected
	2	n.c.	Not connected
	3	RxD/TxD-P	Received/transmitted data P
	4	CNTR-P ¹⁾	Repeater control signal
	5	DGND	Data reference potential (M5V)
	6	VP	Supply voltage (P5V)
	7	n.c.	Not connected
	8	RxD/TxD-N	Received/transmitted data N
	9	n.c.	Not connected
Housing	Screen	Connection to housing	
Bus connection M12 adapter plug (B-coded)			
	Plug and socket		
			
	Plug		
	1	n.c.	Not connected
	2	RxD/TxD-N	Received/transmitted data N
	3	n.c.	Not connected
	4	RxD/TxD-P	Received/transmitted data P
	5 and M12	Screen	Connection to FE
	Socket		
	1	VP	Supply voltage (P5V)
2	RxD/TxD-N	Received/transmitted data N	
3	DGND	Data reference potential (M5V)	
4	RxD/TxD-P	Received/transmitted data P	
5 and M12	Screen	Connection to FE	

1) The repeater control signal CNTR-P is realised as a TTL signal.

Modular electrical peripherals, for type 03/04

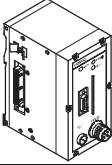
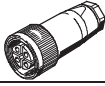
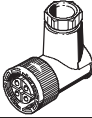
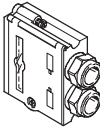
Accessories – Bus node IFB13-03

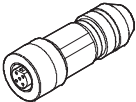
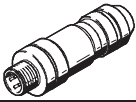
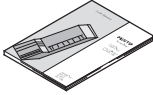
Ordering data			
Designation		Part No.	Type
Bus node			
	Profibus	174335	IFB13-03
Power supply			
	Plug socket, straight, M18x1, 4 pin	for 1.5 mm ²	18493 NTSD-GD-9
		for 2.5 mm ²	18526 NTSD-GD-13,5
	Plug socket, angled, M18x1, 4 pin	for 1.5 mm ²	18527 NTSD-WD-9
		for 2.5 mm ²	533119 NTSD-WD-11
Fieldbus connection			
	Plug, Sub-D	532216	FBS-SUB-9-GS-DP-B
	Bus connection, 2x M12 adapter plug (B-coded)	533118	FBA-2-M12-5POL-RK
	Socket M12x1, 5-pin, straight	for self-assembly of a connecting cable for FBA-2-M12-5POL-RK	1067905 NECU-M-B12G5-C2-PB
	Plug M12x1, 5-pin, straight	for self-assembly of a connecting cable for FBA-2-M12-5POL-RK	1066354 NECU-M-S-B12G5-C2-PB
User documentation			
	User documentation – Bus node IFB13-03	German	163953 P.BE-VIFB13-03-DE
		English	163958 P.BE-VIFB13-03-EN
		French	163933 P.BE-VIFB13-03-FR
		Spanish	163913 P.BE-VIFB13-03-ES
		Italian	165433 P.BE-VIFB13-03-IT
		Swedish	165463 P.BE-VIFB13-03-SV

- 1 - Type discontinued
Available up until 2012

Modular electrical peripherals, for type 03/04

Technical data – Bus node IFB16-03

FESTO

ASA

This bus node handles communication between the modular electrical peripherals and a higher-order master.

For the modular electrical peripherals, this module provides the separate electrical system supply for

- the electronics modules and sensor supply, and
- the load current of the electrical outputs and valves.
- The ASA fieldbus standard (FIPIO) works with a constant transfer rate of 1Mbit/s and is primarily supported on the master side by the Telemecanique and April controllers.
- LED displays on the bus node show the current status of communication on the bus and indicate the presence of various device errors within the valve terminal.



Application

Bus connection

The bus connection on the IFB16-03 is established via two 4-pin M12 plugs that are bridged within the bus node. This means that the bus can be inter-

connected in a serial arrangement with an incoming and an outgoing bus cable or connected to the bus via a

branch line.

The bus address is set by means of 2 rotary switches on the bus node. The

error characteristics of the outputs and the solenoid coil actuator can also be set on the node.

Implementation

The IFB16-03 supports the digital input and output modules and the solenoid coils. It can service a total of 60 digital inputs and 64 digital out-

puts, of which max. 26 can include solenoid coils.

The CP interface module can be connected as an alternative if the CP in-

stallation system is used, however this mode of operation does not support the direct mounting of valves.



Note

Please observe the general guidelines on I/O addressing when assigning the outputs.

Modular electrical peripherals, for type 03/04

Technical data – Bus node IFB16-03

General technical data		
Type	IFB16-03	
Combination with analogue modules	No	
Baud rates	[Mbaud]	1
Addressing range	1 ... 62	
Product profile	STD-P	
Device reference	FSD_C8	
Configuration support	Standard device profile within the configuration software	
Max. no. of solenoid coils	26	
Max. no. of outputs and solenoid coils	64	
Max. no. of inputs	60	
LED diagnostic displays	Power	Operating voltage
	NET	Status of communication
	I/O ERR	Common errors in valve terminal
	ERR	Device-specific errors
Device-specific diagnostics via FIPIO	<ul style="list-style-type: none"> • Short circuit/overload, outputs • Undervoltage of valves • Undervoltage of outputs • Undervoltage of sensor supply 	
Operating voltage	Nominal value	[V DC] 24 polarity-safe
	Permissible range	[V DC] 18 ... 30
	Power failure buffering	[ms] 20
Current consumption	[mA]	200 + total current consumption of inputs, internal
Protection class to EN 60529	IP65	
Temperature range	Operation	[°C] -5 ... +50
	Storage	[°C] -20 ... +60
Materials	Housing	Die-cast aluminium
	Cover	Polyamide
Dimensions (HxWxD)	[mm]	132 x 85 x 125
Grid dimension	[mm]	72
Weight	[g]	1000

- 1 - Type discontinued
Available up until 2012

Modular electrical peripherals, for type 03/04

Technical data – Bus node IFB16-03

FESTO

Connection and display components

The following connection and display components can be found on the bus node cover:

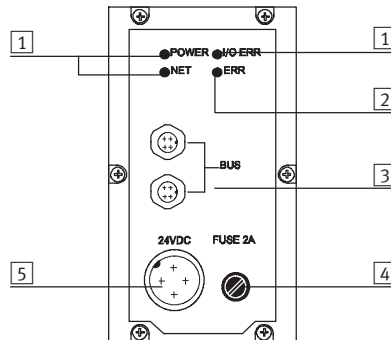

- 1 Green LED / Power
- 2 Red LED / Bus
- 3 Plugs for fieldbus cable
- 4 Fuse for operating voltage of inputs
- 5 Operating voltage connection



Pin allocation for fieldbus interface

Terminal allocation

Terminal allocation	Pin	Signal
	1 Plug 1	1 S+
		2 n.c.
		3 S-
		4 Screen/shield
	2 Plug 2	1 S+
		2 n.c.
		3 S-
		4 Screen/shield
3 Internal RC network		
4 Housing/node		

Modular electrical peripherals, for type 03/04

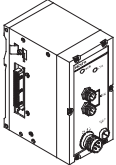
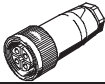
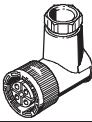
Accessories – Bus node IFB16-03

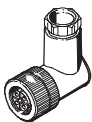
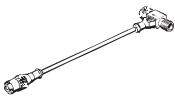
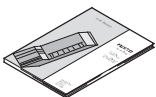
Ordering data			
Designation		Part No.	Type
Bus node			
	For ASA fieldbus standard (FIPIO)	18935	IFB16-03
Power supply			
	Plug socket, straight, M18x1, 4-pin	for 1.5 mm ²	18493 NTSD-GD-9
		for 2.5 mm ²	18526 NTSD-GD-13,5
	Plug socket, angled, M18x1, 4-pin	for 1.5 mm ²	18527 NTSD-WD-9
		for 2.5 mm ²	533119 NTSD-WD-11
Fieldbus connection			
	Bus connection, straight	Pg7	18497 FBSD-GD-7
		Pg9	18495 FBSD-GD-9
		Pg13.5	18496 FBSD-GD-13,5
	Bus connection, angled	Pg7	18524 FBSD-WD-7
		Pg9	18525 FBSD-WD-9
	T-adapter, M12	for Festo fieldbus	18498 FB-TA
	T-adapter for fieldbus, with an open ended cable		18499 FB-TA1
User documentation			
	User documentation – Bus node IFB16-03	German	164221 P.BE-VIFB16-03/05-DE
		English	164222 P.BE-VIFB16-03/05-EN
		Spanish	164223 P.BE-VIFB16-03/05-ES
		French	164224 P.BE-VIFB16-03/05-FR
		Italian	165436 P.BE-VIFB16-03/05-IT
		Swedish	165466 P.BE-VIFB16-03/05-SV

Modular electrical peripherals, for type 03

Technical data – Bus node IFB21-03

FESTO



This bus node handles communication between the modular electrical peripherals type 03 and a higher-order master.

For the modular electrical peripherals, this module provides the separate electrical system supply for

- the electronics modules and sensor supply, and
- the load current of the electrical outputs and valves.
- Interbus with Rugged Line fibre optic connection



Application

Bus connection

The bus connection is established via two Rugged Line fibre optic connections (power supply 5-pin, data fibre optics, typical Interbus allocation). The IFB21-03 corresponds to an Interbus remote bus station.

It supports the transfer of data via fibre optic cables with optical regulation of the individual transmission lengths and the looping through of the

power supply from valve terminal to valve terminal. The power supply is connected via Quickon.

Implementation

The IFB21-03 supports the digital input and output modules and the solenoid coils. It also supports analogue modules. It can service a total of 96 digital outputs, of which

max. 26 can include solenoid coils, and 92 digital inputs. The IFB21-03 supports max. 8 analogue input channels and

8 analogue output channels. The analogue channels are operated in multiplex mode and occupy 16 process data bits.

 Note

Please observe the general guidelines on I/O addressing when assigning the outputs.

Modular electrical peripherals, for type 03

Technical data – Bus node IFB21-03

General technical data			
Type		IFB21-03 ¹⁾	
Combination with analogue modules		Yes	
Baud rates	[kbps]	<ul style="list-style-type: none"> • 500 • 2000 	
ID code		1, 2 or 3 depending on expansion	
No. of process data bits		16, 32, 48, 64, 80 or 96 depending on expansion	
PCP channel		No	
Configuration support		<ul style="list-style-type: none"> • Icon file for CMD software • Station description file with CMD software 	
Max. no. of solenoid coils		26	
Max. no. of outputs incl. solenoid coils		96	
Max. no. of inputs		92	
LED diagnostic displays	IB-DIAG	Interbus diagnostics	
	RC	Remotebus check	
	RD	Remotebus disable	
	FO1	Diagnostics, incoming fibre optic cable length	
	FO2	Diagnostics, outgoing fibre optic cable length	
	US1	Diagnostics, logic voltage	
	US2	Diagnostics, load voltage	
Device-specific diagnostics transmitted to the controller		<ul style="list-style-type: none"> • Short circuit/overload, outputs • Undervoltage of valves • Undervoltage of outputs • Undervoltage of sensor supply • Error during analogue processing 	
Diagnostics via SRC		<ul style="list-style-type: none"> • Operating voltage US1 under 17 V DC • Load voltage of valves/outputs under 21.6 V DC • Load voltage of valves/outputs under 10 V DC • Undervoltage of sensor supply • Short circuit/overload of input module²⁾, 1 ... 12 (module-specific) • Short circuit/overload of output module³⁾, 1 ... 12 (module-specific) 	
Operating voltage	Nominal value	[V DC]	24 polarity-safe
	Permissible range	[V DC]	18 ... 30
	Power failure buffering	[ms]	20
Current consumption		[mA]	150 + total current consumption of inputs, internal
Protection class to EN 60529		IP65	
Temperature range	Operation	[°C]	0 ... +50
	Storage	[°C]	-20 ... +70
Materials	Housing	Die-cast aluminium	
	Cover	Polyamide	
Dimensions (HxWxD)		[mm]	206 x 82 x 109
Grid dimension		[mm]	72
Weight		[g]	1335

1) Only for type 03

2) Only VIGE-03-FB-8-5POL-S

3) Only VIGA-03-FB-4-5POL in NPN

Modular electrical peripherals, for type 03

Technical data – Bus node IFB21-03

Connection and display components

The following connection and display components can be found on the bus node cover:

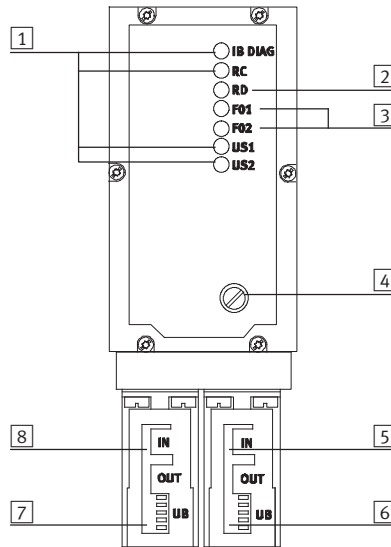

- 1 Green LED
- 2 Red LED
- 3 Yellow LED
- 4 Fuse for operating voltage of inputs
- 5 INTERBUS FOC interface, outgoing
- 6 Voltage supply connection, outgoing
- 7 Voltage supply connection, incoming
- 8 INTERBUS FOC interface, incoming

Designation	Type	
Version	Fibre optic cable (polymer fibres 980/1000 µm)	
Type of transmission	Serial asynchronous, full-duplex	
Protocol	INTERBUS	
Baud rate	500 kbps ... 2 mbps	
Cable type	Power supply	IBS PW R/5 HD/F
	Fibre optic cable	PMS-LWL-RUGGED-FLEX-980/1000 ¹⁾
	Wavelength [µm]	Typical 650
Line length	Between 2 remote bus stations [m]	1 ... 50
	System reserve [db]	3
Plug connector	Rugged Line plug ¹⁾	

1) Can be obtained from Phoenix Contact GmbH

Modular electrical peripherals, for type 03

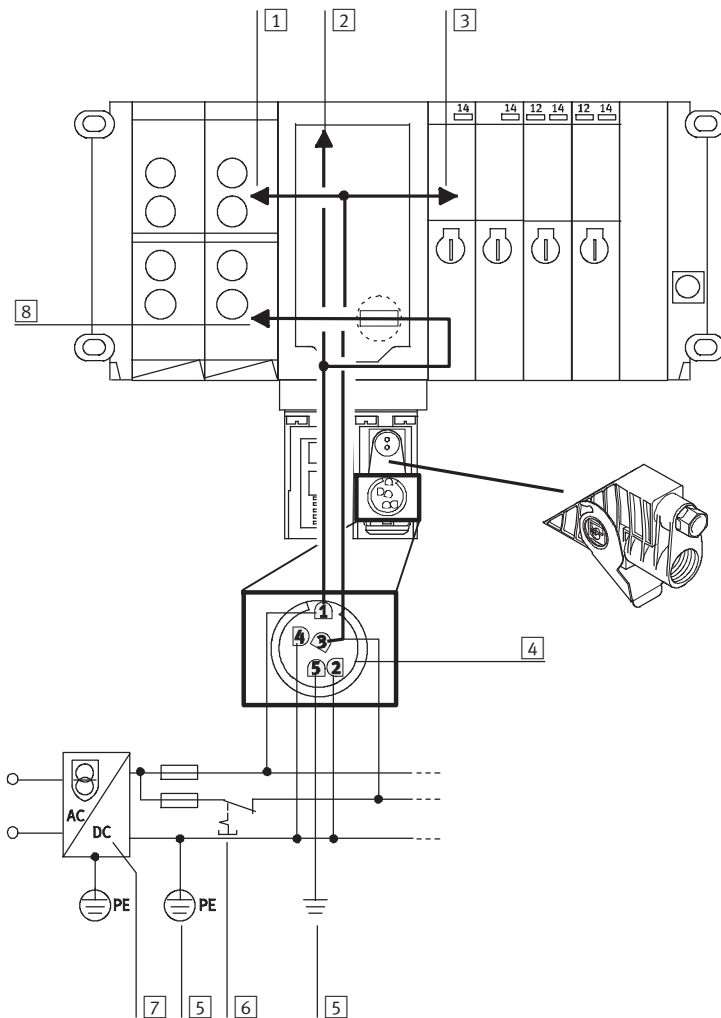

Accessories – Bus node IFB21-03

Example of circuit

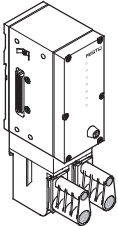

- 1 Electrical outputs (externally fused)
- 2 24 V DC electronics
- 3 Valves
- 4 Voltage supply connection for bus node
- 5 Potential equalisation
- 6 Load voltage, can be disconnected separately
- 7 Power supply unit (e.g. central voltage supply)
- 8 Electrical inputs/sensors

Ordering data

Designation		Part No.	Type
Bus node			
	For Interbus with Rugged Line fibre optic connection (type 03 only)	188844	IFB21-03
User documentation			
	User documentation – Bus node IFB21-03	German	191084 P.BE-VIFB21-03-DE
		English	191085 P.BE-VIFB21-03-EN

- 1 - Type discontinued
Available up until 2012

Modular electrical peripherals, for type 03/04

Technical data – Control block ISF3-03

FESTO

FESTO

A powerful mini controller from Festo has been integrated in the ISF3-03 control block and built into a robust aluminium housing with the protection class IP65. This permits stand-alone control of up to 128 inputs and outputs.



Application

All plugs and electrical connections are designed for direct mounting on the machine outside of the control cabinet (provided that the requirements of IP65 are adhered to).

With the Festo fieldbus, additional I/Os and expanded functions can be installed and controlled. The control block ISF3-03 can be operated as required in stand-alone mode, as a

fieldbus slave or fieldbus master with up to 31 fieldbus slaves.

This controller is programmed via an RS232 programming interface using the software FST200. Alternatively, a display and control unit can be directly connected on-site.

The control block ISF3-03 is a highly compact solution; a stand-alone controller for directly mounted valve

terminals of the type 03/04 or for CP valves and CP I/O modules indirectly connected via the CP installation system.

The elimination of internal wiring to the controller reduces the number of connection points required, thereby shortening the installation time and eliminating sources of potential

errors.

The performance of the controller technology was selected and specially customised to meet the requirements of a valve terminal. Extensive diagnostic information provides information on the status of all components mounted on the valve terminal as well as the sensors and actuators connected to it.

Operating modes

Stand-alone

Valve terminal with control block ISF3-03 for controlling a stand-alone machine. Can be used to autonomously control small stand-alone machines or system components. It can also be used to realise stand-alone subsystems with a discrete function as part of a larger system.

Master

Control block ISF3-03 with a fieldbus extension for controlling systems. The control block ISF3-03 with integrated fieldbus interface facilitates the connection of local inputs and outputs as well as further fieldbus stations. It

can also be used to process automation tasks requiring a large number of electrical sensors and actuators. It can also be used to realise stand-alone subsystems with a discrete function as part of a larger system.

Modular electrical peripherals, for type 03/04

Technical data – Control block ISF3-03

General technical data				
Type		ISF3-03		
Programming device interface		4-pin round plug for PC/ABG/serial coupling (V24/RS232)		
RAM and EEPROM program memory		128 kByte for program, modules, text modules and drivers (4-20 Byte = 1 instruction)		
Processing time for 1024 binary instructions		Approx. 1 ms		
Flags		F0.0 to F31.15 = 512, all remanent		
	No. of time flags	T0 to T31 = 32 (timer preselection remanent)		
	Time range	0.01 s to 655.35 s		
	No. of counting flags	Z0 to Z31, all remanent		
	Counting range	0 to 65535		
Register		R0 to R127, R0 to R99 remanent		
Special FU		Function units 0 to 4096		
Arithmetic functions		+, -, *, :		
Inputs	digital	128		
	analogue	36		
Outputs	digital	128		
	analogue	12		
Programmable inputs/ outputs	CP	64 digital inputs/64 digital outputs incl. solenoid coils		
	Fieldbus	1048 I/O (per station, max. 128 I and 128 O)		
Permissible modules		Overview		
	Programs	P 0 ... P 15 (user programs)		
	Program modules	BAP 0 ... 15 (user programmable)		
	Functional modules	BAF 0 ... 99		
	CFM No.	Application		
	0	Control block	Deletion of internal operands	
	1		Location of short circuits	
	2		Indirect set/reset of local outputs	
	3		Indirect access to FU0 to FU4095	
	4		Measurement of program runtime	
	5		Reading of remanent data words	
	6		Writing of remanent data words	
	10		Assigning operation parameters/reading of counters/timers	
	11		Interrupt-controlled enable/disable of counters/timers	
	21		CP interface	Reading/writing of data CP auxiliary module
	23			Reset of all outputs accessible via CP
	25	Diagnosis of CP valve terminal, input and output modules		
	27	Assigning operation parameters for CP errors		
	28	Recording of CP configuration		

- 1 - Type discontinued
Available up until 2012

Modular electrical peripherals, for type 03/04

Technical data – Control block ISF3-03

FESTO

General technical data			ISF3-03
Type	Functional modules		
	CFM No.	Application	
	40	Fieldbus	Requesting the fieldbus configuration
	41		Master/slave mode: Reading the parameters of a fieldbus station
	42		Master/slave mode: Writing the parameters of a fieldbus station
	43		Reset of all outputs accessible via fieldbus
	44		Fieldbus station status request
	47		Assigning operation parameters for fieldbus errors
	48		Recording of actual configuration
	49		Comparison of actual list with reference list
	50		Reading of fieldbus station information
	51		Fieldbus station reset
	60		Analogue modules
	61	Output of analogue values	
	63	Diagnosis of analogue module	
	90	Control block	Execution of assembler programs (functional modules)
	91		
	92		
	93		
	94		
	95		
	96		
	97		
	98		
	99		
Programming software			FESTO FST200
Communication	Point to point coupling		Yes
	Bus system		Festo fieldbus (master or slave), RS485
Diagnosis			Comprehensive diagnosis, evaluation using FST200 or via inputs into user program

Modular electrical peripherals, for type 03/04

Technical data – Control block ISF3-03

General technical data		
Type	ISF3-03	
Fieldbus interface	2x 4-pin round plug (RS485)	
Protocol	Festo fieldbus	
Cable length (dependent on baud rate)	[m]	Two wire cable, max. 500 ... 4000
Bus address SF master	Permanent (master/slave mode set via FST200)	
Bus address SF slave	Can be set using FST200 (1 ... 31)	
Bus terminal	Can be set using FST200	
Communication SF slave	Max. 12 byte inputs and 12 byte outputs	
Bus station as master	Control block ISF3-03 1 master Max. 31 slaves: Festo valve terminals and digital modules	
Bus station as slave	Control block ISF3-03	
Data exchange (cyclic)	Max. 12 byte inputs and 12 byte outputs, via fieldbus I/O with Festo fieldbus master (e.g. ISF3-03, FPC405, ...)	
Data exchange (acyclic)	Parameter field, max. 256 words	
Parameter/configuration software for SF3 as master	Using a fieldbus configurator integrated in the FST200	
Diagnosis	Comprehensive diagnosis, evaluation using FST200 or via inputs into user program	
Operating voltage	Nominal value	[V DC] 24 polarity-safe
	Permissible range	[V DC] 18 ... 30
	Power failure buffering	[ms] 20
Current consumption pin 1	Control block	[mA] 200
	CP modules	[mA] 560 (internal electronics) + total current consumption of inputs
Current consumption pin 2	Total of all valves switched simultaneously, see technical data on CP valves	
Protection class to EN 60529	IP65	
Temperature range	Operation	[°C] -5 ... +50
	Storage	[°C] -20 ... +70
Material	Housing	Die-cast aluminium
	Cover	Polyamide
Dimensions (HxWxD)	[mm]	132 x 82 x 125
Weight	[g]	1000

- 1 - Type discontinued
Available up until 2012

Modular electrical peripherals, for type 03/04

Technical data – Control block ISF3-03

FESTO

Connection and display components

The following connection and display components can be found on the control block cover:

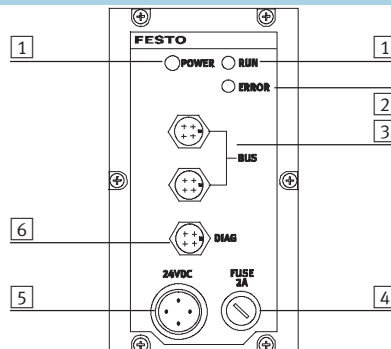

- 1 Green LEDs
- 2 Red LED
- 3 Plug for fieldbus cable
- 4 Fuse for operating voltage of inputs
- 5 Operating voltage connection
- 6 Diagnostic interface

Pin allocation for fieldbus interface





Terminal allocation	Pin	Signal
	1	S+
	2	n.c.
	3	S-
	4	Screen/shield
	1	S+
	2	n.c.
	3	S-
	4	Screen/shield
3	Internal network	
4	Housing/node	

Pin allocation for diagnostic interface

Terminal allocation	Pin	Signal
	1	RxD
	2	TxD
	3	GND
	4	Screen

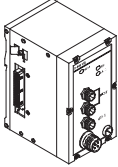
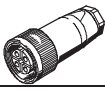
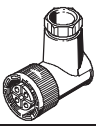
Modular electrical peripherals, for type 03/04

Accessories – Control block ISF3-03

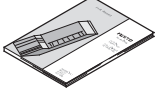
Ordering data			
Designation		Part No.	Type
Control block			
	A powerful mini controller. This permits stand-alone control of up to 128 inputs and outputs.	164287	ISF3-03
Power supply			
	Plug socket, straight	for 1.5 mm ²	18493 NTSD-GD-9
		for 2.5 mm ²	18526 NTSD-GD-13,5
	Plug socket, angled	for 1.5 mm ²	18527 NTSD-WD-9
		for 2.5 mm ²	533119 NTSD-WD-11
Fieldbus connection			
	Bus connection, straight	Pg7	18497 FBSD-GD-7
		Pg9	18495 FBSD-GD-9
		Pg13.5	18496 FBSD-GD-13,5
	Bus connection, angled	Pg7	18524 FBSD-WD-7
		Pg9	18525 FBSD-WD-9
Diagnostic/data connection			
	Programming cable	150268	KDI-SB202-BU9
User documentation			
	User documentation – FST200 programming software	German	165484 P.BE-FST200-AWL/KOP-DE
		English	165489 P.BE-FST200-AWL/KOP-EN
	User documentation – Control block ISF3-03	German	165481 P.BE-VISF3-03-DE
		English	165486 P.BE-VISF3-03-EN
		Spanish	165496 P.BE-VISF3-03-ES
		French	165491 P.BE-VISF3-03-FR
		Italian	165446 P.BE-VISF3-03-IT

Modular electrical peripherals, for type 03/04

Technical data – Input module, digital, 4-/8-fold

Function

Digital input modules facilitate the connection of proximity sensors or other 24 V DC sensors (inductive, capacitive, etc.). Plugs with double allocation are separated using a DUO plug or DUO cable. These modules cannot be operated on the multi-pin node with inputs.

Applications

- Input modules for 24 V DC sensor signals
- M12 plug, single allocation connection technology in 4-fold modules, double allocation connection technology in 8-fold modules
- M12 plug, 5-pin
- The input statuses are indicated for each input signal at an allocated LED
- 24 V DC supply provided for all connected sensors
- Module width: 36 mm



General technical data			
Type	VIGE-03-FB-8-5POL	VIGE-03-FB-4-5POL	VIGE-03-FB-8,1-5POL
Input type	Standard inputs, PNP	Input plug with single allocation, PNP	High-speed inputs, PNP
No. of inputs	8	4	8
No. of occupied module positions	1		
Sensor connection type	4xM12, 5-pin, socket with double allocation	4xM12, 5-pin, socket with single allocation	4xM12, 5-pin, socket with double allocation
Max. power supply per channel	[A]	2	
Max. sensor supply per module	[A]	2	
Fuse protection for sensor supply	Central fuse 2 A, in system supply		
Current consumption of module	[mA]	Typical 12	
Supply voltage of sensors	[V DC]	24 ±25%, coming from bus node	
Switching level	Signal 0	[V DC]	≤5 DC
	Signal 1	[V DC]	≥10 DC
Input delay	[ms]	3	0.6
Switching logic	PNP (for input signals with positive logic)		
Input characteristic curve	To IEC 1131-2		
Protection class to EN 60529	IP65 (when fully plugged-in or fitted with protective cover)		
Temperature range	Operation	[°C]	-5 ... +50
	Storage	[°C]	-20 ... +70
Material	Die-cast aluminium		
Dimensions	[mm]	132 x 36 x 70	
Grid dimension	[mm]	36	
Weight	[g]	360	

Modular electrical peripherals, for type 03/04

Technical data – Input module, digital, 4-/8-fold

General technical data			
Type		VIGE-03-FB-8-5POL-S	
Input type		With separate fuse, PNP	
No. of inputs		8	
No. of occupied module positions		1	
Sensor connection type		4xM12, 5-pin, socket with double allocation	
Max. power supply per channel		[A]	2
Max. sensor supply per module		[A]	0.5
Fuse protection for sensor supply		Internal electrical fuse	
Current consumption of module		[mA]	Typical 12
Supply voltage of sensors		[V DC]	24 ±25%, coming from bus node
Switching level	Signal 0	[V DC]	≤6
	Signal 1	[V DC]	≤8.6
Input delay		[ms]	3
Switching logic		PNP (for input signals with positive logic)	
Input characteristic curve		To IEC 11 31-2	
Protection class to EN 60529		IP65 (when fully plugged-in or fitted with protective cover)	
Temperature range	Operation	[°C]	-5 ... +50
	Storage	[°C]	-20 ... +70
Material		Die-cast aluminium	
Dimensions		[mm]	132 x 36 x 70
Grid dimension		[mm]	36
Weight		[g]	360

Modular electrical peripherals, for type 03/04

Technical data – Input module, digital, 4-/8-fold

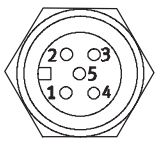
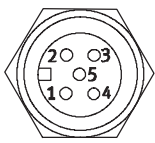
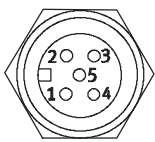
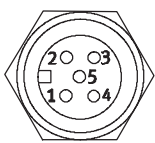

Pin allocation						
Terminal allocation	4-fold			8-fold		
	Pin	Signal	LED	Pin	Signal	LED
5-pin input modules						
	1	+24 V	0	1	+24 V	0
	2	n.c.		2	Ix+1	
	3	0 V		3	0 V	
	4	Ix		4	Ix	
	5	Earth terminal		5	Earth terminal	
	1	+24 V	1	1	+24 V	2
	2	n.c.		2	Ix+3	
	3	0 V		3	0 V	
	4	Ix+1		4	Ix+2	
	5	Earth terminal		5	Earth terminal	
	1	+24 V	2	1	+24 V	4
	2	n.c.		2	Ix+5	
	3	0 V		3	0 V	
	4	Ix+2		4	Ix+4	
	5	Earth terminal		5	Earth terminal	
	1	+24 V	3	1	+24 V	6
	2	n.c.		2	Ix+7	
	3	0 V		3	0 V	
	4	Ix+3		4	Ix+6	
	5	Earth terminal		5	Earth terminal	

Ix Input x

Modular electrical peripherals, for type 03/04

FESTO

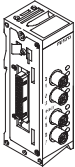
Accessories – Input module, digital, 4-/8-fold

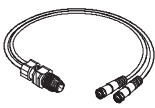
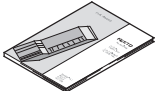
Ordering data			
Designation		Part No.	Type
Input module, digital			
	8 digital inputs, positive logic (PNP), standard inputs	175555	VIGE-03-FB-8-5POL
	4 digital inputs, positive logic (PNP), input plug with single allocation	175557	VIGE-03-FB-4-5POL
	8 digital inputs, positive logic (PNP), high-speed inputs	175559	VIGE-03-FB-8,1-5POL
	8 digital inputs, positive logic (PNP), with separate fuse	188521	VIGE-03-FB-8-5POL-S
Sensor plug			
	Plug, straight socket, M12	5-pin, PG7	175487 SEA-M12-5GS-PG7
		4-pin, PG7	18666 SEA-GS-7
		4-pin, 2.5 mm ² OD	192008 SEA-4GS-7-2,5
	Plug for 2 sensor cables, M12, PG11	4-pin	18779 SEA-GS-11-DUO
		5-pin	192010 SEA-5GS-11-DUO
DUO cable			
	DUO cable	2x straight socket	18685 KM12-DUO-M8-GDGD
		2x straight/angled socket	18688 KM12-DUO-M8-GDWD
		2x angled socket	18687 KM12-DUO-M8-WDWD
User documentation			
	Manual for input/output modules	German	371189 P.BE-VIEA-03-DE
		English	371190 P.BE-VIEA-03-EN
		French	377786 P.BE-VIEA-03-FR
		Spanish	371191 P.BE-VIEA-03-ES
		Italian	371192 P.BE-VIEA-03-IT
		Swedish	371193 P.BE-VIEA-03-SV

Modular electrical peripherals, for type 03/04

Technical data – Input module, digital, 16-fold

FESTO

Function

Sensor signals in groups of up to 8 or 12 are recorded by multi-pin distributors and forwarded to the module via a multi-pin cable.

Applications

- Input modules for 24 V DC sensor signals
- 2 connector plugs, Sub-D 15-pin socket
- Ready for installation for multi-pin distributors with up to 8 or 12 inputs
- Allocation of the plug variables
 - 8 inputs on top and 8 inputs on bottom
 - 12 inputs on top and 4 inputs on bottom
- The input statuses are indicated for each input signal at an assigned LED
- 24 V DC voltage supplied separately for both plugs, with separate electronic fuse
- Module width: 36 mm



General technical data			
Type	VIGE-03-FB-16-SUBD-S		
No. of inputs			16
No. of occupied module positions			2
Sensor connection type			2x Sub-D, 15-pin socket
Max. sensor supply per connection	[A]		0.5
Max. sensor supply per module	[A]		1
Fuse protection for sensor supply			Separate electronic fuse for each connection
Current consumption of module	[mA]		12
Supply voltage of sensors	[V DC]		24 ±25%, coming from bus node
Switching level	Signal 0	[V DC]	≤6
	Signal 1	[V DC]	≥8.6
Input delay		[ms]	3
Switching logic			PNP (for input signals with positive logic)
Input characteristic curve			To IEC 1131-2
Protection class to EN 60529			IP65 (when fully plugged-in or fitted with protective cover)
Temperature range	Operation	[°C]	–5 ... +50
	Storage	[°C]	–20 ... +70
Material			Die-cast aluminium
Dimensions (HxWxD)		[mm]	132 x 36 x 56
Grid dimension		[mm]	36
Weight		[g]	360

Modular electrical peripherals, for type 03/04

Technical data – Input module, digital, 16-fold

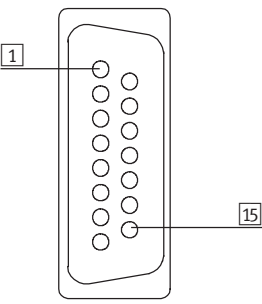
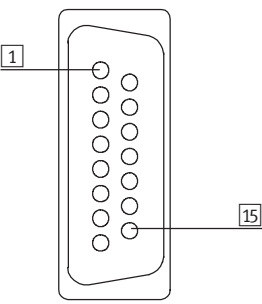
Pin allocation		
Terminal allocation	Pin	Signal
	1	Ix
	2	Ix+1
	3	Ix+2
	4	Ix+3
	5	Ix+4
	6	Ix+5
	7	Ix+6
	8	Ix+7
	9	Ix+8 ¹⁾
	10	Ix+9 ¹⁾
	11	Ix+10 ¹⁾
	12	Ix+11 ¹⁾
	13	24 V DC sensor supply
	14	0 V
	15	PE housing
	1	Ix+8 ¹⁾
	2	Ix+9 ¹⁾
	3	Ix+10 ¹⁾
	4	Ix+11 ¹⁾
	5	Ix+12
	6	Ix+13
	7	Ix+14
	8	Ix+15
	9	Free
	10	Free
	11	Free
	12	Free
	13	24 V DC sensor supply
	14	0 V
	15	PE housing

Ix Input x

1) Two sets of inputs signals, connect to either of the two plugs.

Modular electrical peripherals, for type 03/04

FESTO

Accessories – Input module, digital, 16-fold

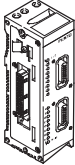
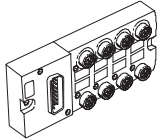
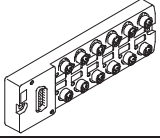
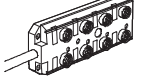
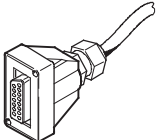
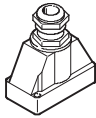
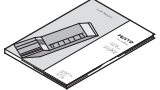
Ordering data			
Designation		Part No.	Type
Input module, digital			
	16 digital inputs, positive logic (PNP), 2x Sub-D, 15-pin socket	192549	VIGE-03-FB-16-SUBD-S
Multi-pin distributors Technical data → 72			
	15-pin socket Sub-D / 8x 3-pin M8 plugs	8 I/Os	177669 MPV-E/A08-M8
	15-pin socket Sub-D / 12x 3-pin M8 plugs	12 I/Os	177670 MPV-E/A12-M8
	15-pin connecting cable / 8x 5-pin M12 plugs	8 I/Os	177671 MPV-E/A08-M12
Cables and plugs			
	Plug socket with cable, open at one end	5 m	177673 KMPV-SUB-D-15-5
		10 m	177674 KMPV-SUB-D-15-10
	Plug socket Sub-D, plug		192768 SD-SUB-D-ST15
User documentation			
	Manual for input/output modules	German	371189 P.BE-VIEA-03-DE
		English	371190 P.BE-VIEA-03-EN
		French	377786 P.BE-VIEA-03-FR
		Spanish	371191 P.BE-VIEA-03-ES
		Italian	371192 P.BE-VIEA-03-IT
		Swedish	371193 P.BE-VIEA-03-SV

Modular electrical peripherals, for type 03/04

Technical data – Output module, digital

Function

The electrical outputs control actuators such as individual valves, hydraulic valves, heating controllers and many more.

 Note
Valves with M12 central plug, optimum control.

Applications





- Output module with 4 outputs
24 V DC
- M12 connection technology, with 5-pin sockets
- LED display of the switching status per channel
- Short circuit and overload detection per output
 - Separate malfunction display for each channel by means of red LED
 - Diagnostic message about system status to controller



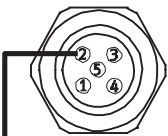

General technical data			VIGA-03-FB-4-5POL
Type			VIGA-03-FB-4-5POL
Output type			Standard outputs, PNP
No. of outputs			4
No. of occupied module positions			1
Output connection type			4xM12, 5-pin, socket with double allocation
Max. output current	per channel	[A]	0.5
	per module	[A]	2.0
Operating voltage	[V DC]		24 ±25%
Load voltage connection	[V DC]		24 ±10%
Parallel connection possible			Yes, within the module only
Fuse protection for output line			Electronic fuse per channel 0.5 A
Current consumption of module	[mA]		9
Overload/short circuit protection			Per channel
Switching logic			To IEC 1131-2
Protection class to EN 60529			IP65 (when fully plugged-in or fitted with protective cover)
Temperature range	Operation	[°C]	–5 ... +50
	Storage	[°C]	–20 ... +70
Material			Die-cast aluminium
Dimensions (HxWxD)	[mm]		132 x 36 x 69
Grid dimension	[mm]		36
Weight	[g]		360

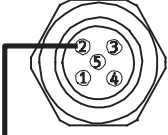
Modular electrical peripherals, for type 03/04

Accessories – Output module, digital

Pin allocation – Standard			
Terminal allocation	LED	Pin	Signal
	0	1	n.c.
		2	Ox+1
		3	0 V
		4	Ox
		5	Earth terminal
	1	1	n.c.
		2	n.c.
		3	0 V
		4	Ox+1
		5	Earth terminal
	2	1	n.c.
		2	Ox+3
		3	0 V
		4	Ox+2
		5	Earth terminal
	3	1	n.c.
		2	n.c.
		3	0 V
		4	Ox+3
		5	Earth terminal

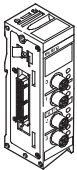
1 Internal connection in module
 Ox Output x

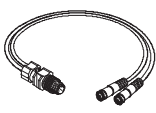
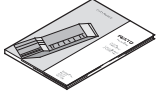
Ordering data			
Designation	Part No.	Type	
Output module, digital			
	4 digital outputs, positive logic (PNP), standard outputs	175641	VIGA-03-FB-4-5POL
Sensor plug			
	Plug, straight socket, M12	5-pin, Pg7	175487 SEA-M12-5GS-PG7
	Plug for 2 sensor cables, M12, PG11	5-pin	192010 SEA-5GS-11-DUO
DUO cable			
	DUO cable	2x straight socket	18685 KM12-DUO-M8-GDGD
		2x straight/angled socket	18688 KM12-DUO-M8-GDWD
		2x angled socket	18687 KM12-DUO-M8-WDWD
User documentation			
	Manual for input/output modules	German	371189 P.BE-VIEA-03-DE
		English	371190 P.BE-VIEA-03-EN
		French	377786 P.BE-VIEA-03-FR
		Spanish	371191 P.BE-VIEA-03-ES
		Italian	371192 P.BE-VIEA-03-IT
		Swedish	371193 P.BE-VIEA-03-SV

Modular electrical peripherals, for type 03/04

Technical data – Input/output module

FESTO

Function

Digital input modules facilitate the connection of proximity sensors or other 24 V DC sensors (inductive, capacitive, etc.).

The electrical outputs control actuators such as individual valves, lamps and a host of other devices.

The I/O module occupies 3 module positions.

Its electrical isolation makes it suitable as a coupling connection to external circuits.

Applications

The I/O module combines 12 inputs and 8 outputs in one module with a width of 72 mm. The connection is established via a pre-assembled 25-pin Sub-D plug with multi-pin cable. 24 V DC internal supply to the sensor connections. The switching status displays for the inputs/outputs are shown on assigned LEDs.

4 outputs are combined into a group and supplied externally with 24 V DC. The inputs and outputs are electrically isolated from the node.



General technical data			
Type		VIEA-03-FB-12E-8A-SUBD	
Number	Inputs	12	
	Outputs	8	
No. of occupied module positions		3	
Sensor connection and output type		25-pin multi-pin cable and Sub-D plug connector	
Max. power supply per channel	[A]	2	
Max. sensor supply per module	[A]	2	
Fuse protection for sensor supply		Central fuse 2 A, in system supply	
Current consumption of module		Typically 8 mA (inputs) 5 mA (outputs) per group of four	
Capacity per digital output	[A]	0.5 internal electronic fuse	
Supply voltage of sensors		[V DC]	24 ±25%, coming from bus node
Switching level	Signal 0	[V DC]	≤ 5
	Signal 1	[V DC]	≥ 11
Input delay	[ms]	5	
Switching logic		PNP (for input signals with positive logic)	
Input characteristic curve		To IEC 11 31-2	
Protection class to EN 60529		IP65 (when fully plugged-in or fitted with protective cover)	
Temperature range	Operation	[°C]	–5 ... +50
	Storage	[°C]	–20 ... +70
Material		Die-cast aluminium	
Dimensions (HxWxD)		[mm]	132 x 78 x 78
Grid dimension		[mm]	72
Weight		[g]	700

Modular electrical peripherals, for type 03/04

Accessories – Input/output module

FESTO

Pin allocation				
	Pin	Signal	Core colour of data cable KEA-1-25P-...	
	1	Ix	white	
	2	Ix+1	green	
	3	Ix+2	yellow	
	4	Ix+3	grey	
	5	Ix+4	pink	
	6	Ix+5	blue	
	7	Ix+6	red	
	8	Ix+7	magenta	
	9	Ix+8	grey-pink	
	10	Ix+9	red-blue	
	11	Ix+10	white-green	
	12	Ix+11	brown-green	
	13	0 V of inputs	white-yellow	
	14	Ox	yellow-brown	
	15	Ox+1	white-grey	
	16	Ox+2	grey-brown	
	17	Ox+3	white-pink	
	18	Ox+4	pink-brown	
	19	Ox+5	white-blue	
	20	Ox+6	brown-blue	
	21	Ox+7	white-red	
	22	24 V DC (for the outputs Ox ... Ox+3)		brown-red
	23	24 V DC (for the outputs Ox+4 ... Ox+7)		white-black
	24	0 V (for the outputs Ox ... Ox+3)		brown
	25	0 V (for the outputs Ox+4 ... Ox+7)		black

Ix Input x
Ox Output x

Ordering data				
Designation			Part No.	Type
Input/output module, digital				
	12 digital inputs, 8 digital outputs		174483	VIEA-03-FB-12E-8A-SUBD
Cables and plugs				
	Connecting cable	5 m	177413	KEA-1-25P-5
		10 m	177414	KEA-1-25P-10
		x length	177415	KEA-1-25P-X
	Plug socket Sub-D, socket		18709	SD-SUB-D-BU25
User documentation				
	Manual for input/output modules	German	371189	P.BE-VIEA-03-DE
		English	371190	P.BE-VIEA-03-EN
		French	377786	P.BE-VIEA-03-FR
		Spanish	371191	P.BE-VIEA-03-ES
		Italian	371192	P.BE-VIEA-03-IT
		Swedish	371193	P.BE-VIEA-03-SV

Modular electrical peripherals, for type 03/04

Technical data – Analogue stage

Function

Analogue signals, as well as digital inputs and outputs, are required in many areas of automation. Special analogue stages are provided for these tasks which are capable of processing both analogue input signals, e.g. setpoint specifications and feedback on actual values (temperature, pressure, flow rate, fill-level, etc.), as well as analogue outputs for controlling actuators. The analogue stages are specially prepared for the connection of proportional valves¹⁾.

Applications

- 6-pin push-in connectors to DIN 45 332
- Diagnostic LED to indicate readiness for service and overload
- Voltage supplied for all connected sensors

Three analogue stages are available for different fields of application:

- VIAP-03-FB, optimised for proportional valves
 - 1 analogue input (4 ... 20 mA)
 - 1 analogue output (4 ... 20 mA)
- VIAU-03-FB-I, universal module for current signals
 - 3 analogue inputs (4 ... 20 mA)
 - 1 analogue output (4 ... 20 mA)
- VIAU-03-FB-U, universal module for voltage signals
 - 3 analogue inputs (0 ... 10 V)
 - 1 analogue output (0 ... 10 V)



1) Not suited for MPPES

General technical data		VIAP-03-FB ¹⁾	VIAU-03-FB-I ¹⁾	VIAU-03-FB-U ¹⁾
Number	Inputs	1	3	3
	Outputs	1	1	1
Sensor connection type		1x 6-pin socket, DIN 45322	3x 6-pin socket, DIN 45322	
Max. sensor supply per module [A]		2		0.5
Fuse protection for sensor supply		Central fuse 2 A, in system supply		
Current consumption of module [mA]		64		
Supply voltage of sensors [V DC]		24 ±25%, coming from bus node		
Actuator supply voltage [V DC]		24 ±10%, external		
Actuator supply, average continuous loading capability [A]		Max. 0.5	Max. 1	
Analogue current inputs	Signal range	4 ... 20 mA		0 ... 10 V DC
	Resolution [bit]	11		12
	No. of units	2 048		4 096
	Absolute precision [%]	0.45		0.4
	Input resistance [kΩ]	0.050		≥ 20
	Max. permissible input current [mA]	65		
Input voltage [V DC]		–		30
Input signal cut-off frequency [Hz]		100	116	
Linearity	Differential non-linearity	2 LSB		
	Integral non-linearity	3 LSB		

1) Not suited for MPPES

- 7 - Type discontinued
Available up until 2012

Modular electrical peripherals, for type 03/04

FESTO

Technical data – Analogue stage

General technical data			
Type		VIAP-03-FB ¹⁾	VIAU-03-FB-I ¹⁾
Analogue current inputs/outputs	Signal range	4 ... 20 mA	
	Resolution [bit]	12	
	No. of units	4 096	
	Absolute precision [%]	0.5	0.45
	Load resistance (load) [kΩ]	≤ 0.250	≥ 3.3
Linearity	Differential non-linearity	2 LSB	
	Integral non-linearity	4 LSB	
Protection class to EN 60529		IP65 (when fully plugged-in or fitted with protective cover)	
Temperature range	Operation [°C]	-5 ... +50	
	Storage [°C]	-20 ... +70	
Material		Die-cast aluminium	
Dimensions (HxWxD)	[mm]	132 x 42 x 70	
Grid dimension	[mm]	36	
Weight	[g]	360	

1) Not suited for MPPES

Pin allocation		
Terminal allocation	Signal	Signal designation
Analogue stage VIAP-03-FB		
	IIO+	Positive current, input signal
	IIO-	Negative current, input signal
	OIO+	Positive current, output signal
	OGND	Current output signal
	24 V _p	24 V DC actuator supply voltage
	0 V	0 V actuator supply voltage
	Housing	Cable screening connection

Modular electrical peripherals, for type 03/04

Technical data – Analogue stage



Pin allocation			Signal	Signal designation
Analogue stage VIAU-03-FB-I (current signals)				
	I10-	n.c.	I1x+	Positive current, input signal
	I10+	n.c.	I1x-	Negative current, input signal
	0 V	24 V _{Sen}	O10+	Positive current, output signal
			OGND	Current output signal
			24 V _{Sen}	24 V DC sensor supply voltage
			24 V _p	24 V DC actuator supply voltage
			0 V	0 V actuator/sensor supply voltage
			Housing	Cable screening connection
Analogue stage VIAU-03-FB-U (voltage signals)				
	n.c.	IU0+	IUx+	Positive voltage, input signal
	n.c.	IU0-	IUx-	Negative voltage, input signal
	0 V	24 V _{Sen}	OU0+	Positive voltage, output signal
			OGND	Voltage output signal
			24 V _{Sen}	24 V DC sensor supply voltage
			24 V _p	24 V DC actuator supply voltage
			0 V	0 V actuator/sensor supply voltage
			Housing	Cable screening connection

 Type discontinued
Available up until 2012

FESTO

Modular electrical peripherals, for type 03/04

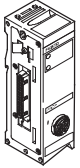
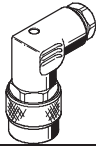
Accessories – Analogue stage

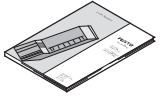
Ordering data				
Designation			Part No.	Type
Input module, analogue				
	1 analogue input and 1 analogue output, optimised for proportional valves		18691	VIAP-03-FB
	3 analogue inputs and 1 analogue output, universal module for current signals		164239	VIAU-03-FB-I
	3 analogue inputs and 1 analogue output, universal module for voltage signals		18692	VIAU-03-FB-U
Connecting cables				
	Connecting cable for Festo proportional pressure regulator, plug/socket pre-assembled at both ends	5 m	163882	KVIA-MPPE-5
		10 m	163883	KVIA-MPPE-10
	Connecting cable for Festo proportional directional control valve, plug/socket pre-assembled at both ends	5 m	161984	KVIA-MPYE-5
		10 m	161985	KVIA-MPYE-10
	Connecting cable for other signal modules, open cable end	5 m	163960	KVIA-5
		10 m	163961	KVIA-10
User documentation				
	User documentation – Analogue stage	German	163946	P.BE-VIAX-03/05-DE
		English	163947	P.BE-VIAX-03/05-EN
		French	163948	P.BE-VIAX-03/05-FR
		Spanish	163949	P.BE-VIAX-03/05-ES
		Italian	165379	P.BE-VIAX-03/05-IT
		Swedish	165539	P.BE-VIAX-03/05-SV

Modular electrical peripherals, for type 03/04

Technical data – Electrical interface for CP interface

Function

The CP interface electrical interface module establishes the connection to a CP installation system. I/O data from the CP installation system is transferred to the connected bus node, and then to the higher-order controller via the fieldbus.

As well as transmitting the communication data, the max. 4 CP strings also transmit the supply voltage to the connected sensors and the load supply to the valves. The two circuits are isolated and are supplied with power by the connected bus node or control block.

Applications

The following bus nodes/control blocks support the CP interface electrical interface.

Bus nodes:

- IFB8-03 1771 Remote I/O
- IFB16-03 ASA (FIPIO) bus

The CP interface electrical interface occupies one bus node exclusively. Additional local valves or further electrical I/O modules cannot be connected.

Control blocks:

- ISF3-03 Festo machine controller
- Further local valves or electrical I/Os can be connected.



General technical data			VIGCP-03-FB
Type			
Brief description		CP interface	
Max. no. of CP modules per string		1 output module or valve terminal and 1 input module	
Number	CP strings	4	
	Outputs	64	
	Inputs	64	
	Occupied module positions	1	
Supply voltage of sensors	[V DC]	24 ±25%, coming from bus node	
Actuator supply voltage	[V DC]	24 ±10%, coming from bus node	
Cycle time	[ms]	< 5 at full expansion	
Current consumption	[mA]	90	
Protection class to EN 60529		IP65 (when fully plugged-in or fitted with protective cover)	
Temperature range	Operation	[°C]	+5 ... +50
	Storage	[°C]	-20 ... +70
Material		Die-cast aluminium	
Dimensions (HxWxD)		[mm]	132 x 36 x 53
Grid dimension		[mm]	36
Weight		[g]	310

- 1 - Type discontinued
Available up until 2012

Modular electrical peripherals, for type 03/04

Accessories – Electrical interface for CP interface

FESTO

Connection and display components

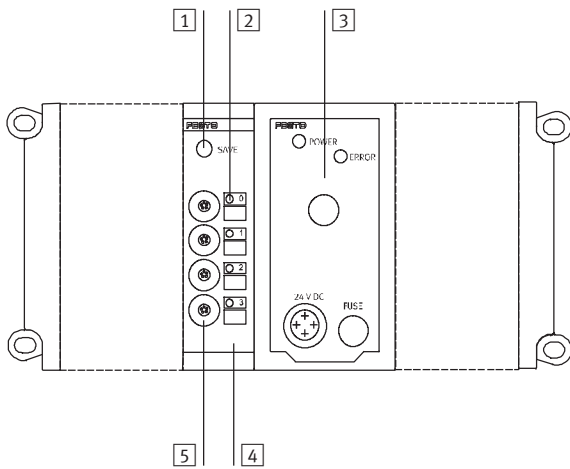

- 1 SAVE key
- 2 String error LEDs
- 3 Control block ISF3-03
- 4 Inscription areas
- 5 CP connections for up to 4 strings (0 ... 3)

Example of circuit

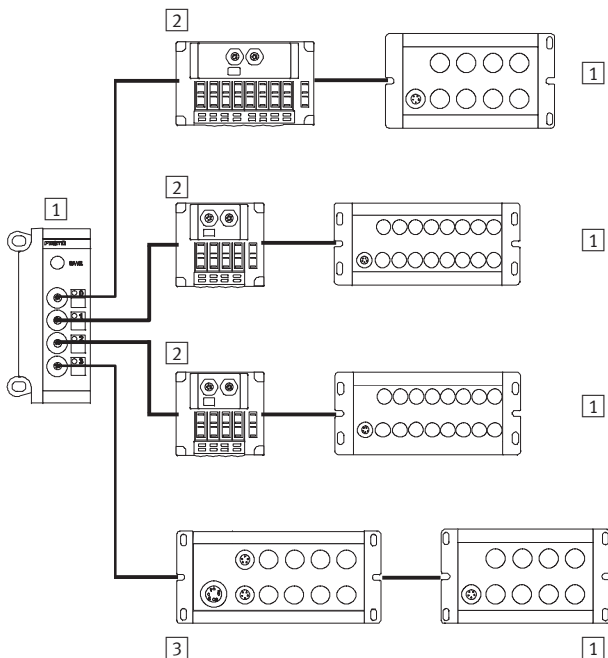

- 1 CP input module
- 2 Valve terminals type 10 CPV and type 12 CPA, Compact Performance
- 3 CP output module

You will find further information



- ➔ Internet: type 10 for valve terminal type 10 CPV, Compact Performance
- ➔ Internet: type 12 for valve terminal type 12 CPA, Compact Performance
- ➔ Internet: ctec for electrical installation system, for CPV/CPA

- 2 - Type discontinued
Available up until 2012

Modular electrical peripherals, for type 03/04

FESTO

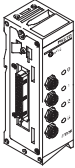
Accessories – Electrical interface for CP interface

Ordering data			
Designation		Part No.	Type
CP interface			
	Interface for max. 8 I/O modules and valve terminals from the CP system	18229	VIGCP-03-FB
Cables			
	Connecting cable WS-WD, angled plug-angled socket	0.25 m	540327 KVI-CP-3-WS-WD-0,25
		0.5 m	540328 KVI-CP-3-WS-WD-0,5
		2 m	540329 KVI-CP-3-WS-WD-2
		5 m	540330 KVI-CP-3-WS-WD-5
		8 m	540331 KVI-CP-3-WS-WD-8
	Connecting cable GS-GD, straight plug-straight socket	2 m	540332 KVI-CP-3-GS-GD-2
		5 m	540333 KVI-CP-3-GS-GD-5
		8 m	540334 KVI-CP-3-GS-GD-8

Modular electrical peripherals, for type 03/04

Technical data – Multi-pin distributor

Function

MPV multi-pin distributors are suitable for the distribution of input and output signals to PNP sensors and solenoid valves via the M12/M8 plugs. The multi-pin distributors, in conjunction with the input module VIGE-03-FB-16-SUBD-S (→ 58), collect the sensor signals directly in the machine and forward them to the input module on the 15-pin Sub-D sockets via a multi-pin cable.

- LED for signal status display
- Only one cable to installation location
- A broad range of accessories

Type MPV-E/A...-M8

The multi-pin distributor facilitates the connection of max. 8 or 12 input signals to 3-pin M8x1 plugs. The connecting cable KMPV-SUB-D-15-..., pre-assembled at one end, with the 15-pin Sub-D socket is connected to the multi-pin distributor. The open end of the cable is fitted with the plug socket SD-SUB-D-ST15 and connected to the input module.

Type MPV-E/A08-M12

Connection of max. 8 input signals to 5-pin M12 plug. The connecting cable is permanently attached to the multi-pin distributor. The open end of the cable is fitted with the plug socket SD-SUB-D-ST15 and connected to the input module. Switching status display via yellow LED. Sensor voltage display via green LED.

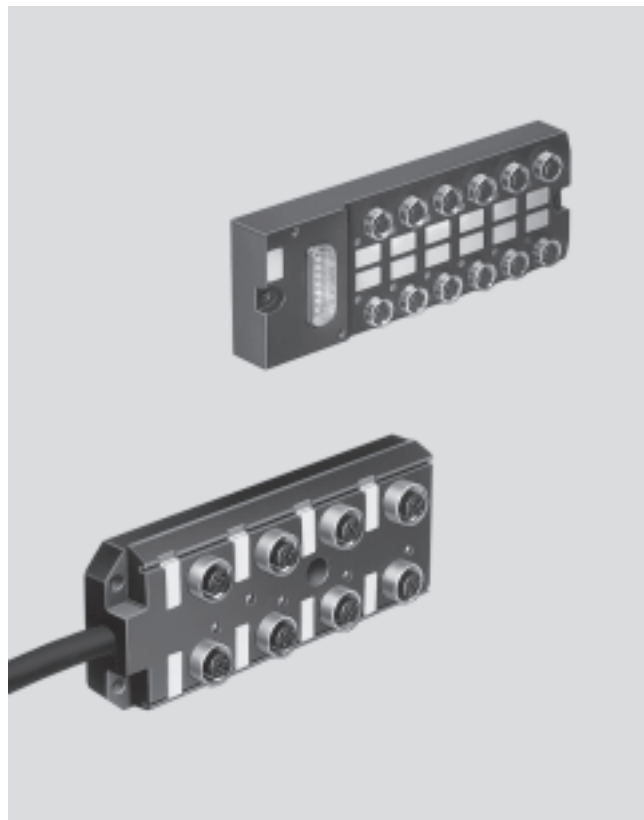

General technical data				
Type		MPV-E/A08-M8	MPV-E/A12-M8	MPV-E/A08-M12
No. of inputs/outputs		8	12	8
Type of mounting		2 through-holes or on H-rail ¹⁾		3 through-holes
Connection		M8x1, 3-pin		M12x1, 5-pin
Permissible voltage	[V DC]	10 ... 30		10 ... 30
Current-carrying capacity	[A]	Max. 1 per module slot Total current: max. 4		Max. 4 per module slot Total current: max. 12
Protection class to EN 60529		IP65 (fully assembled)		IP67 (fully assembled)
Temperature range	Operation	-20 ... +80		-20 ... +80
	Storage	-20 ... +80		-20 ... +80
Materials	Housing	Polyamide		Polyurethane
	Sockets	Brass, gold plated		Galvanised brass
	Cable	-		Polyurethane, polyvinyl chloride
Weight	[g]	100 ²⁾	120 ²⁾	200 ²⁾

1) With adapter CP-TS-HS-35

2) Without cable

Modular electrical peripherals, for type 03/04

Technical data – Multi-pin distributor

Dimensions

Download CAD data → www.festo.com

MPV-E/A...-M8

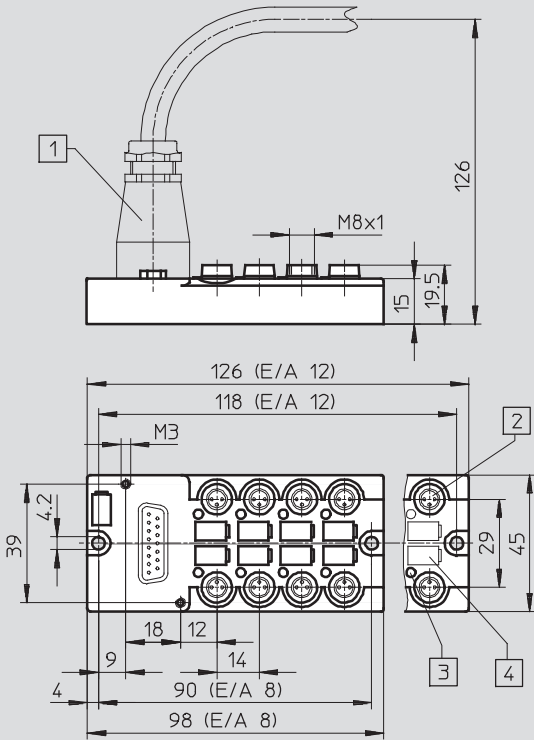

- 1 Multi-pin connection
- 2 3-pin socket, M8x1
- 3 Switching status display, yellow
- 4 Inscription label (type IBS-6x10)

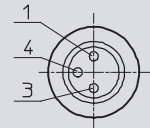

- 1 24 V DC
- 3 0 V
- 4 Signal line (1 ... 8) or (1 ... 12)

MPV-E/A08-M12

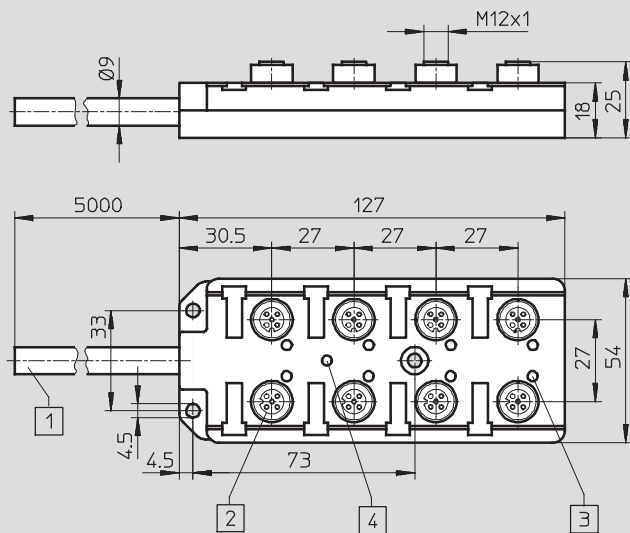

- 1 Connecting cable, 5 m
- 2 5-pin socket, M12 x 1
- 3 Switching status display, yellow
- 4 Voltage display, green

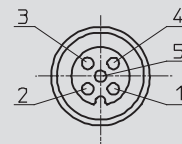





- 1 24 V DC
- 2 n.c.
- 3 0 V
- 4 Signal line (1 ... 8)
- 5 Earth

Modular electrical peripherals, for type 03/04

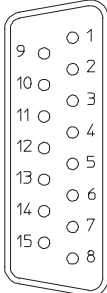
Accessories – Multi-pin distributor

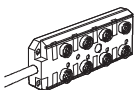
FESTO

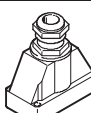



Pin allocation	MPV-E/A...-M8			MPV-E/A08-M12	
	Cable with 15-pin Sub-D plug			Signal line pins 1 through 12	
	Pin	M8 socket location	Core colour	M12 socket location	Core colour
	1	0/4	white	1/4	white
	2	1/4	brown	2/4	green
	3	2/4	green	3/4	yellow
	4	3/4	yellow	4/4	grey
	5	4/4	grey	5/4	pink
	6	5/4	pink	6/4	red
	7	6/4	blue	7/4	black
	8	7/4	red	8/4	magenta
	9	8/4	black	24 V DC	brown
	10	9/4	magenta	0 V	blue
	11	10/4	grey-pink	PE	green-yellow
	12	11/4	red-blue		
	13	24 V DC	white-green		
	14	0 V	brown-green		
	15	0 V	white-yellow		

Ordering data for MPV-E/A08-M12				
Designation			Part No.	Type
Multi-pin distributors				
	15-pin connecting cable / 8x 5-pin M12 plugs		177671	MPV-E/A08-M12
Plugs and cables				
	Connecting cable for sensors, M12-M12		2.5 m	18684 KM12-M12-GSGD-2,5
			5 m	18686 KM12-M12-GSGD-5
	Plug socket ¹⁾		192768	SD-SUB-D-ST15
Protective cover				
	Cover caps (10 pieces) for unused terminals		165592	ISK-M12

1) A Sub-D plug socket is required to establish a connection between the multi-pin distributor and input module VIGE-03-FB-16-SUBD-S.

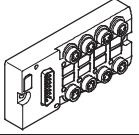
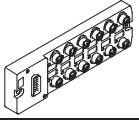
Modular electrical peripherals, for type 03/04

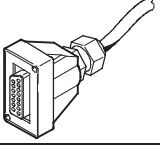
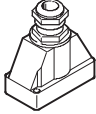
Accessories – Multi-pin distributor

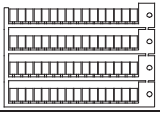
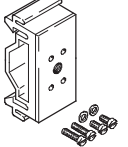
Ordering data for MPV-E/A...-M8			
Designation		Part No.	Type
Multi-pin distributors			
	15-pin socket Sub-D / 8x 3-pin M8 plugs	177669	MPV-E/A08-M8
	15-pin socket Sub-D / 12x 3-pin M8 plugs	177670	MPV-E/A12-M8
Plugs and cables			
	Connecting cable for sensors, M8-M8	2.5 m	165610 KM8-M8-GSGD-2,5
		5 m	165611 KM8-M8-GSGD-5
	Plug socket with cable, open at one end ¹⁾	5 m	177673 KMPV-SUB-D-15-5
		10 m	177674 KMPV-SUB-D-15-10
	Plug socket ¹⁾	192768	SD-SUB-D-ST15
Protective cover			
	Cover caps (10 pieces) for unused terminals	177672	ISK-M8
Designation			
	Inscription labels, pack of 64	18576	IBS-6x10
Mounting			
	Attachment for H-rail mounting, 2 pieces	170169	CP-TS-HS-35

1) A plug socket with cable and a Sub-D plug socket are required to establish a connection between the multi-pin distributor and input module VIGE-03-FB-16-SUBD-S.

Modular electrical peripherals, for type 03/04

Technical data

FESTO

Dimensions – Electrical peripherals with valve terminal type 03
with bus node/control block

Download CAD data → www.festo.com

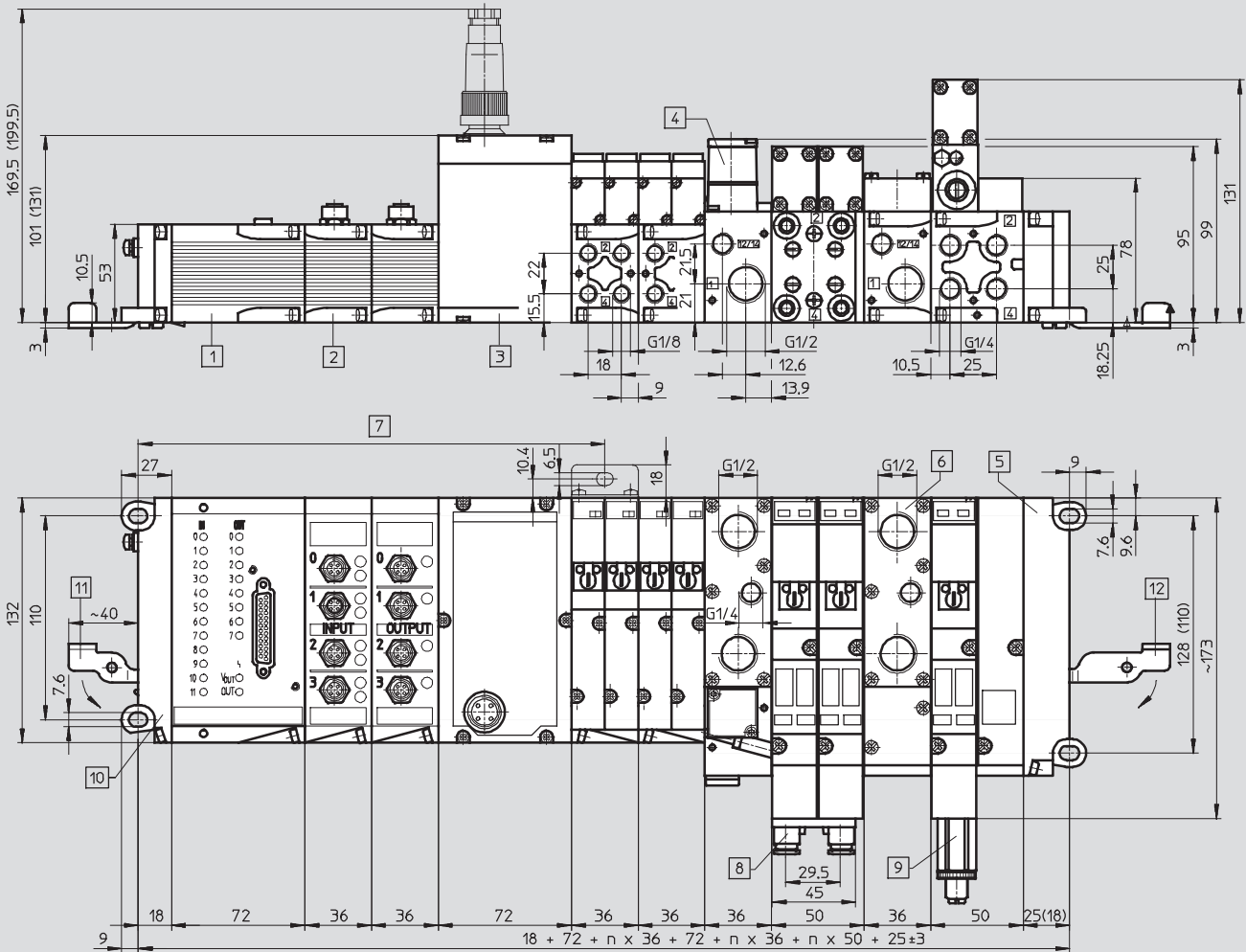

- | | | | |
|--------------------------|---|--|--|
| 1 Input/output module | 4 Adapter plate MIDI/MAXI with pressure regulating valve for pilot pressure | 7 Mounting bracket for wall mounting required approx. every 200 mm | 11 Swivel lever IBGH-03-4.0 (opened out) for connection to mounting rail |
| 2 Input module | 5 End plate, right-hand (dimensions for MIDI valves in brackets) | 8 One-way flow control valve | 12 Swivel lever IBGH-03-7.0 (opened out) for connection to mounting rail |
| 3 Fieldbus/control block | 6 Compressed-air supply plate | 9 Pressure regulating valve | |
| | | 10 End plate, left-hand | |

Modular electrical peripherals, for type 03/04

Technical data

Dimensions – End plates for valve terminal 03

Download CAD data → www.festo.com

MIDI valves

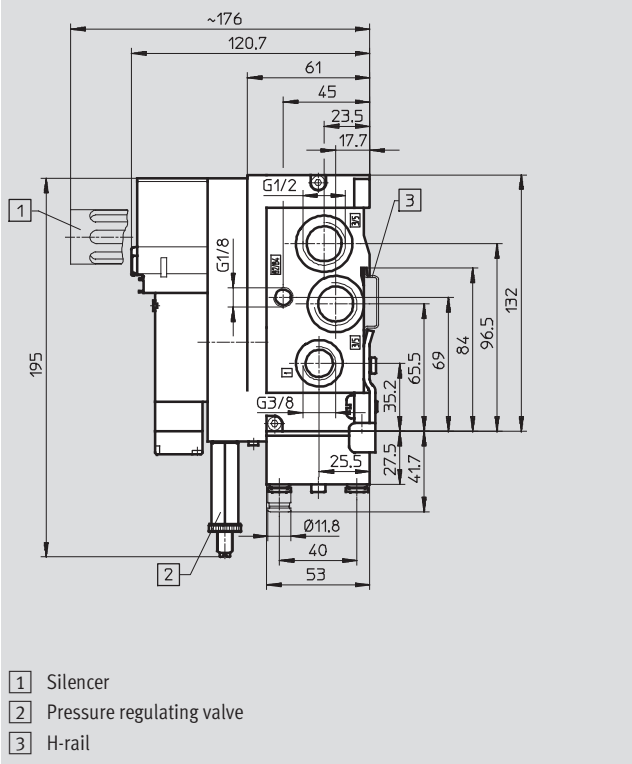

MAXI valves

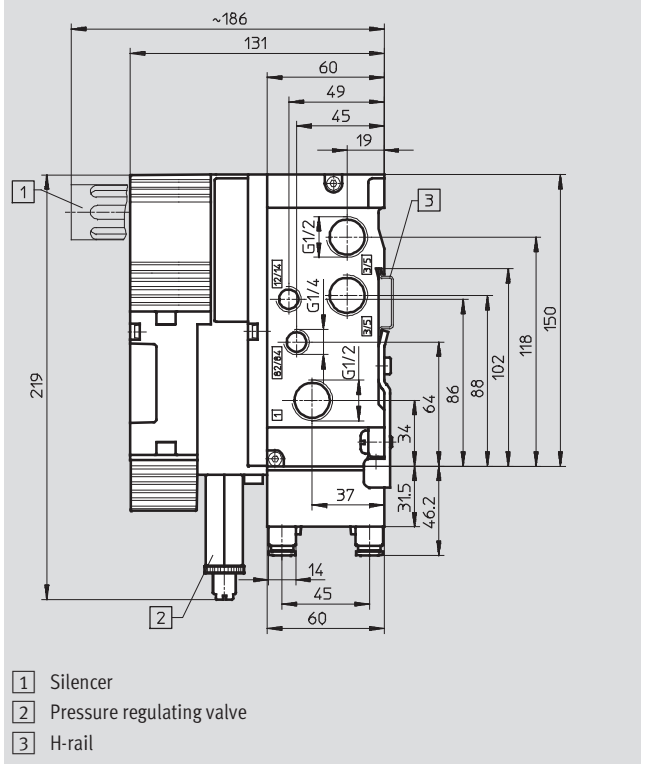

Modular electrical peripherals, for type 03/04

Technical data

FESTO

Dimensions – Electrical peripherals with valve terminal type 04
with bus node/control block

Download CAD data → www.festo.com

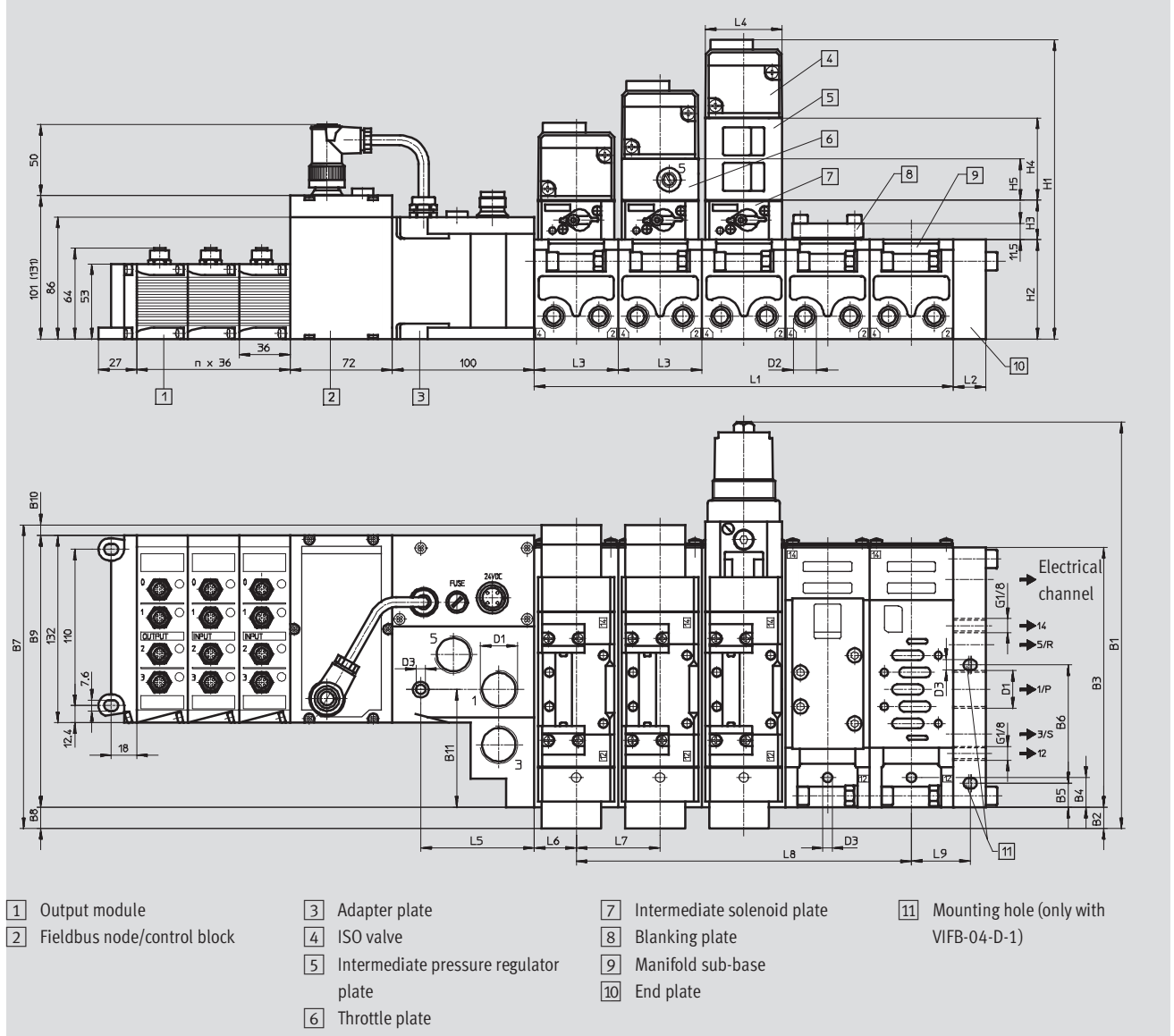

Type	~B1	B2	B3	B4	B5	B6	B7	B8	B9	B10	B11	D1	D2	D3
VIFB-04-D-1-B	251	33	149	7	17	80	198.5	33	153	12.4	56.9	G½	G¼	6.6
VIFB-04-D-2-B	287	15	183	21	–	–	214	15	191.5	7.5	83	G¾	G¾	6.6
VIFB-04-D-3-B	315	6	230	27	–	–	241.5	6	231.6	3.9	79.5	G1	G½	9

Type	H1	H2	H3	H4	H5	L1 ¹⁾	L2	L3	L4	L5	L6	L7	L8 ¹⁾	L9
VIFB-04-D-1-B	181.7	64	27	45	25.5	m x 43	22	43	42	80	9.5	43	(m-1) x 43	44.5
VIFB-04-D-2-B	210.8	70	27.8	58	29	m x 59	23	59	54	80	29.5	59	(m-1) x 59	–
VIFB-04-D-3-B	235	82	28	63	40	m x 72	28	72	70	52	36	72	(m-1) x 72	–

1) m = Number of valves

Modular electrical peripherals, for type 03/04

Accessories

Product range overview – Connections for bus nodes and control blocks									
Designation	Type	FB5	FB6	FB8	FB11	FB13	FB16	FB21	SF3
Fieldbus connection									
Bus connection, straight, Pg7	FBSD-GD-7	■	-	■	-	-	■	-	■
Bus connection, straight, Pg9	FBSD-GD-9	■	-	■	-	-	■	-	■
Bus connection, straight, Pg9, 5-pin	FBSD-GD-9-5POL	-	-	-	■	-	-	-	-
Bus connection, straight, Pg1 3.5	FBSD-GD-13,5	■	-	■	-	-	■	-	■
Bus connection, angled, Pg7	FBSD-WD-7	■	-	■	-	-	■	-	■
Bus connection, angled, Pg9	FBSD-WD-9	■	-	■	-	-	■	-	■
Plug, Sub-D	FBS-SUB-9-GS-DP-B	-	-	-	-	■	-	-	-
Bus connection, 2x M12 adapter plug (B-coded)	FBA-2-M12-5POL-RK	-	-	-	-	■	-	-	-
T-adapter for fieldbus, with pre-assembled socket component	FB-TA	■	-	■	-	-	■	-	-
T-adapter for fieldbus, with free cable end	FB-TA1	■	-	■	-	-	■	-	-
Interbus standard round plug ¹⁾		-	■	-	-	-	-	-	-
Interbus "Rugged Line" FOC plug ¹⁾		-	-	-	-	-	-	■	-
Power supply									
Plug socket, straight, for 1.5 mm ²	NTSD-GD-9	■	■	■	■	■	■	-	■
Plug socket, straight, for 2.5 mm ²	NTSD-GD-13,5	■	■	■	■	■	■	-	■
Plug socket, angled, for 1.5 mm ²	NTSD-WD-9	■	■	■	■	■	■	-	■
Plug socket, angled, for 2.5 mm ²	NTSD-WD-11	■	■	■	■	■	■	-	■
Diagnostic/data connection									
Programming cable	KDI-SB202-BU9	-	-	-	-	-	-	-	■

1) Not a Festo product, order from Phoenix Contact

Product range overview – Electrical connection technology for modules					
Designation	Type	Input module		Output module	Input/output module
		4-/8-fold VIGE-...	16-fold VIGE-...	VIGA-...	VIEA-...
Plugs and sockets					
Plug, straight socket, M12, 4-pin, Pg7	SEA-GS-7	■	-	■	-
Plug, straight socket, M12, 4-pin, 2.5 mm ² OD	SEA-4GS-7-2,5	■	-	■	-
Plug, straight socket, M12, 5-pin, Pg7	SEA-M12-5GS-PG7 ¹⁾	■	-	■	-
Plug for 2 sensor cables, M12, Pg11, 4-pin	SEA-GS-11-DUO	■	-	■	-
Plug for 2 sensor cables, M12, Pg11, 5-pin	SEA-5GS-11-DUO ¹⁾	■	-	■	-
Plug socket Sub-D, plug	SD-SUB-D-ST15	-	■	-	-
Plug socket Sub-D, socket	SD-SUB-D-BU25	-	-	-	■
Cables					
Connecting cable, 5 m	KEA-1-25P-5	-	-	-	■
Connecting cable, 10 m	KEA-1-25P-10	-	-	-	■
Connecting cable, x length	KEA-1-25P-X	-	-	-	■
DUO cable, 2x straight socket	KM12-DUO-M8-GDGD	■	-	■	-
DUO cable, 2x straight/angled socket	KM12-DUO-M8-GDWD	■	-	■	-
DUO cable, 2x angled socket	KM12-DUO-M8-WDWD	■	-	■	-
Plug socket with cable, open at one end, 5 m	KMPV-SUB-D-15-5	-	■	-	-
Plug socket with cable, open at one end, 10 m	KMPV-SUB-D-15-10	-	■	-	-

1) 5-pin cable, cannot be used with 4-pin connectors

 Type discontinued
Available up until 2012

Modular electrical peripherals, for type 03/04

FESTO







Accessories

Product range overview – Electrical connection technology for modules				
Designation	Type	Analogue stage		Electrical interface
		VIAP-...	VIAU-...	VIGCP-... 
Cables				
Connecting cable, angled plug, angled socket, 0.25 m	KVI-CP-3-WS-WD-0,25	–	–	■
Connecting cable, angled plug, angled socket, 0.5 m	KVI-CP-3-WS-WD-0,5	–	–	■
Connecting cable, angled plug, angled socket, 2 m	KVI-CP-3-WS-WD-2	–	–	■
Connecting cable, angled plug, angled socket, 5 m	KVI-CP-3-WS-WD-5	–	–	■
Connecting cable, angled plug, angled socket, 8 m	KVI-CP-3-WS-WD-8	–	–	■
Connecting cable, straight plug, straight socket, 2 m	KVI-CP-3-GS-GD-2	–	–	■
Connecting cable, straight plug, straight socket, 5 m	KVI-CP-3-GS-GD-5	–	–	■
Connecting cable, straight plug, straight socket, 8 m	KVI-CP-3-GS-GD-8	–	–	■
Connecting cable for Festo proportional pressure regulator, 5 m	KVIA-MPPE-5	■	■	–
Connecting cable for Festo proportional pressure regulator, 10 m	KVIA-MPPE-10	■	■	–
Connecting cable for Festo proportional directional control valve, 5 m	KVIA-MPYE-5	■	■	–
Connecting cable for Festo proportional directional control valve, 10 m	KVIA-MPYE-10	■	■	–
Connecting cable for other signal modules, open cable end, 5 m	KVIA-5	■	■	–
Connecting cable for other signal modules, open cable end, 10 m	KVIA-10	■	■	–

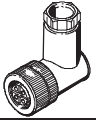
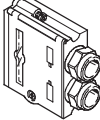
1) 5-pin cable, cannot be used with 4-pin connectors

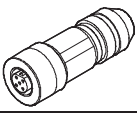
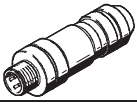
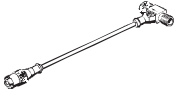
Modular electrical peripherals, for type 03/04

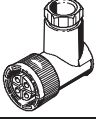

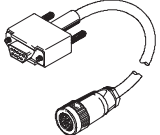

Accessories

Ordering data				
Designation			Part No.	Type
Fieldbus connection				
	Bus connection, straight, M12	Pg7, 4-pin	18497	FBSD-GD-7
		Pg9, 4-pin	18495	FBSD-GD-9
		Pg9, 5-pin	18324	FBSD-GD-9-5POL
		Pg13.5, 4-pin	18496	FBSD-GD-13,5
	Bus connection, angled, M12	Pg7, 4-pin	18524	FBSD-WD-7
		Pg9, 4-pin	18525	FBSD-WD-9
	Plug socket Sub-D, IP65, 9-pin	for Profibus DP	532216	FBS-SUB-9-GS-DP-B
	Bus connection socket, straight, Sub-D, 9-pin (B-coded, ReverseKey)	2xM12 adapter 5-pin for Profibus DP	533118	FBA-2-M12-5POL-RK
	Socket M12x1, 5-pin, straight	for self-assembly of a connecting cable for FBA-2-M12-5POL-RK	1067905	NECU-M-B12G5-C2-PB
	Plug M12x1, 5-pin, straight	for self-assembly of a connecting cable for FBA-2-M12-5POL-RK	1066354	NECU-M-S-B12G5-C2-PB
	T-adapter, M12	for Festo fieldbus	18498	FB-TA
	T-adapter for fieldbus, with an open ended cable		18499	FB-TA1
Power supply				
	Plug socket, straight, M18x1	4-pin for 1.5 mm ²	18493	NTSD-GD-9
		4-pin for 2.5 mm ²	18526	NTSD-GD-13,5
	Plug socket, angled, M18x1	4-pin for 1.5 mm ²	18527	NTSD-WD-9
		4-pin for 2.5 mm ²	533119	NTSD-WD-11
	Plug socket, straight, M12	4-pin, Pg7	18497	FBSD-GD-7
		4-pin, Pg9	18495	FBSD-GD-9
	Plug socket, angled, M12	4-pin, Pg7	18524	FBSD-WD-7
		4-pin, Pg9	18525	FBSD-WD-9
Diagnostic/data connection				
	Programming cable		150268	KDI-SB202-BU9

Modular electrical peripherals, for type 03/04

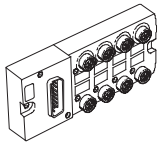
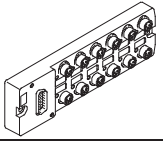
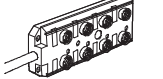
FESTO

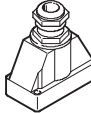
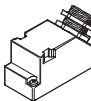
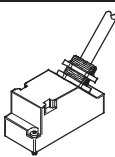
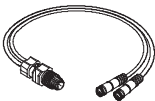

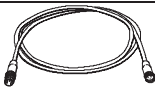



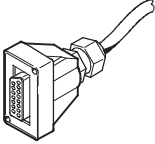

Accessories

Ordering data				
Designation			Part No.	Type
Multi-pin distributors				
	15-pin socket Sub-D / 8x 3-pin M8 plugs	8 I/Os	177669	MPV-E/A08-M8
	15-pin socket Sub-D / 12x 3-pin M8 plugs	12 I/Os	177670	MPV-E/A12-M8
	15-pin connecting cable / 8x 5-pin M12 plugs	8 I/Os	177671	MPV-E/A08-M12
Plugs and sockets				
	Plug, straight socket, M12, 5-pin	5-pin, Pg7	175487	SEA-M12-5GS-PG7 ¹⁾
	Plug, straight socket, M12, 4-pin	4-pin, Pg7	18666	SEA-GS-7
		4-pin, Pg9	18778	SEA-GS-9
		2.5 mm ² OD	192008	SEA-4GS-7-2,5
	Plug for 2 sensor cables, M12	4-pin, Pg11	18779	SEA-GS-11-DUO
		5-pin, Pg11	192010	SEA-5GS-11-DUO ¹⁾
	Plug socket Sub-D, plug, 15-pin		192768	SD-SUB-D-ST15
	Plug socket Sub-D, socket, 25-pin		18709	SD-SUB-D-BU25
Cables				
	Connecting cable, 25-wire	5 m	177413	KEA-1-25P-5
		10 m	177414	KEA-1-25P-10
		x length	177415	KEA-1-25P-X
	DUO cable, straight plug, M12, 4-pin, 2xM12, 3-pin	2x straight socket	18685	KM12-DUO-M8-GDGD
		2x straight/angled socket	18688	KM12-DUO-M8-GDWD
		2x angled socket	18687	KM12-DUO-M8-WDWD
	Connecting cable for sensores, M12, 4-pin	1 m, straight plug, angled socket	185499	KM12-M12-GSWD-1-4
		2.5 m, straight plug, straight socket	18684	KM12-M12-GSGD-2,5
		5 m straight plug, straight socket	18686	KM12-M12-GSGD-5
	Connecting cable for sensores, M8, 3-pin	1 m, straight plug, straight socket	175489	KM8-M8-GSGD-1
		2.5 m, straight plug, straight socket	165610	KM8-M8-GSGD-2,5
		5 m, straight plug, straight socket	165611	KM8-M8-GSGD-5

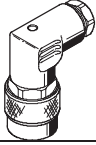
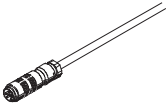
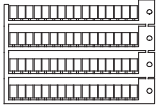
1) 5-pin cable, cannot be used with 4-pin connectors

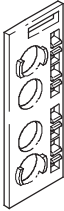
Modular electrical peripherals, for type 03/04

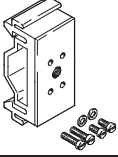
Accessories

Ordering data			
Designation		Part No.	Type
Cables			
	Plug socket with cable, open at one end, 15-wire	5 m	177673 KMPV-SUB-D-15-5
		10 m	177674 KMPV-SUB-D-15-10
	Connecting cable WS-WD, angled plug-angled socket	0.25 m	540327 KVI-CP-3-WS-WD-0,25
		0.5 m	540328 KVI-CP-3-WS-WD-0,5
		2 m	540329 KVI-CP-3-WS-WD-2
		5 m	540330 KVI-CP-3-WS-WD-5
		8 m	540331 KVI-CP-3-WS-WD-8
	Connecting cable GS-GD, straight plug-straight socket	2 m	540332 KVI-CP-3-GS-GD-2
		5 m	540333 KVI-CP-3-GS-GD-5
		8 m	540334 KVI-CP-3-GS-GD-8
	Connecting cable for Festo proportional pressure regulator	5 m	163882 KVIA-MPPE-5
		10 m	163883 KVIA-MPPE-10
	Connecting cable for Festo proportional directional control valve	5 m	161984 KVIA-MPYE-5
		10 m	161985 KVIA-MPYE-10
	Connecting cable for other signal modules, open cable end	5 m	163960 KVIA-5
		10 m	163961 KVIA-10
Inscription labels and label holders			
	Inscription labels, 6x10, 64 pieces in frames	18576	IBS-6x10
	Inscription labels, 9x20, 20 pieces in frames	18182	IBS-9x20
	Holders for inscription labels for I/O modules, pack of 5	18183	IBT-03-E/A
General accessories			
	Tamper proof cap (10 pieces) for unassigned connections	for MPV-E/A08-M12	165592 ISK-M12
		for MPV-E/A...-M8	177672 ISK-M8
	Mounting for H-rail, 2 pieces	for MPV-E/A...-M8	170169 CP-TS-HS-35
Programming software			
	Programming software FST200 with manual for control block ISF3-03	German	165484 P.BE-FST200-AWL/KOP-DE
		English	165489 P.BE-FST200-AWL/KOP-EN