









- Adjustable or self-adjusting
- With linear or progressive characteristic
- Stop elements:
combination of cushioning and
end-position sensing
- Specified types in accordance with ATEX
directive for potentially explosive atmo-
spheres
→ www.festo.com/en/ex

Cushioning components

Product range overview

Function	Type	Version	Brief description	Area of application
Shock absorber	Elastomer absorber			
	DYEF-Y1		<ul style="list-style-type: none"> • Mechanical shock absorber with flexible rubber buffer • Cushioning stroke cannot be adjusted • No fixed stop • Continuous mounting thread with internal hex 	<ul style="list-style-type: none"> • Mini slide DGSL
	DYEF-Y1F		<ul style="list-style-type: none"> • Mechanical shock absorber with flexible rubber buffer • Cushioning stroke can be adjusted • With fixed stop • Continuous mounting thread with internal hex 	<ul style="list-style-type: none"> • Mini slide DGSL • Swivel module DSM-B • Semi-rotary drive DRQD-B
	Adjustable			
	DYSR		<ul style="list-style-type: none"> • Hydraulic shock absorber with spring return • Adjustable cushioning hardness 	–
	Self-adjusting			
	YSR-C		<ul style="list-style-type: none"> • Hydraulic shock absorber with path-controlled flow control function • Rapidly increasing cushioning force curve • Short cushioning stroke • Suitable for rotary drives • Maintenance-free • Continuous mounting thread 	<ul style="list-style-type: none"> • Linear drive DGPL • Linear drive DGC • Linear unit SLE
	DYSC		<ul style="list-style-type: none"> • Hydraulic shock absorber with path-controlled flow control function • Rapidly increasing cushioning force curve • Short cushioning stroke • Suitable for rotary drives • Maintenance-free • Metal end position at the housing • Continuous mounting thread with internal hex 	<ul style="list-style-type: none"> • Swivel module DSM-B • Swivel/linear unit DSL-B
	YSRW		<ul style="list-style-type: none"> • Hydraulic shock absorber with path-controlled flow control function • Slowly increasing cushioning force curve • Long cushioning stroke • Suitable for low-vibration operation • Short cycle times possible • Maintenance-free • Continuous mounting thread with spanner flat 	<ul style="list-style-type: none"> • Linear drive DGC • Linear module HMP, HMPL • Handling module HSP, HSW
	DYSW		<ul style="list-style-type: none"> • Hydraulic shock absorber with path-controlled flow control function • Slowly increasing cushioning force curve • Long cushioning stroke • Suitable for low-vibration operation • Short cycle times possible • Maintenance-free • Metal end position at the housing • Continuous mounting thread with internal hex 	<ul style="list-style-type: none"> • Mini slide DGSL • Handling module HSW

Cushioning components

Product range overview

Size	Stroke [mm]	Energy absorption per stroke [J]	Position sensing	Free of copper, PTFE and silicone	→ Page/Internet
Elastomer absorber					
M4, M5, M6, M8, M10, M12, M14, M16	0.9, 1.0, 1.2, 1.3, 1.5	0.015 ... 0.55	-	■	7
M4, M5, M6, M8, M10, M12, M14, M16, M22	1.7, 2.8, 3.1, 3.4, 3.7, 4.2, 5, 4.8, 7	0.005 ... 1.2	-	■	10
Adjustable					
8, 12, 16, 20, 25, 32	8, 12, 20, 25, 40, 60	4 ... 384	-	-	14
Self-adjusting					
4, 5, 7, 8, 10, 12, 16, 20, 25, 32	4, 5, 8, 10, 12, 20, 25, 40, 60	0.6 ... 380	-	■ Size 4 ... 20	18
5, 7, 8, 12, 16	5, 8, 12, 18	1 ... 25	-	■	22
5, 7, 8, 10, 12, 16, 20	8, 10, 14, 17, 20, 26, 34	1.3 ... 70	-	■	26
4, 5, 7, 8, 10, 12	6, 8, 10, 14, 17, 20	0.8 ... 12	-	■	30

Cushioning components

Product range overview

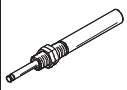
Function	Type	Version	Brief description	Area of application
Stop element	Self-adjusting			
	YSRWJ		<ul style="list-style-type: none"> • Cushioning with self-adjusting, progressive hydraulic shock absorber (YSRW) • Slowly increasing cushioning force curve • Adjustable cushioning stroke • End-position sensing with proximity sensors SME/SMT-8 • Precision end-position adjustment • Stop elements YSRWJ can be used for a wide variety of applications in handling and assembly technology 	<ul style="list-style-type: none"> • Linear module HMPL
Hydraulic cushioning cylinder	Adjustable			
	DYHR		<ul style="list-style-type: none"> • Hydraulic cushioning cylinder for constant, slow braking speeds across the entire stroke • Braking speed can be precisely adjusted • A built-in compression spring returns the piston rod to the initial position • Suitable for slow feed speeds in the range up to 0.1 m/s 	–

Cushioning components

Product range overview

FESTO

Size	Stroke [mm]	Energy absorption per stroke [J]	Position sensing	Free of copper, PTFE and silicone	→ Page/Internet
Self-adjusting					
5, 7, 8	8, 10, 14	1 ... 3	■	-	34
Adjustable					
16, 20, 25, 32	20, 25, 40, 50, 60	32 ... 384	-	-	38

Shock absorbers DYE- ... -Y1, without fixed stop

Type codes



DYEF – S – M8 – Y1

Type

DYEF	Shock absorber
------	----------------

Version

	Long
S	Short



Size

Design characteristic

Y1	Internal hex
----	--------------

Shock absorbers DYEF- ... -Y1, without fixed stop

Technical data

-  - Size
M4 ... M16
-  - Stroke length
0.9 ... 1.5 mm



General technical data									
Size	M4	M5	M6	M8	M10	M12	M14	M16	
Stroke [mm]	0.9	1.5	1.5	1.3	1	1.2	1.2	1.3	
Mode of operation	Elastomer cushioning without metal fixed stop								
Cushioning	Not adjustable								
Cushioning length [mm]	0.9	1.5	1.5	1.3	1	1.2	1.2	1.3	
Type of mounting	Via lock nut								
Max. impact velocity [m/s]	0.8								
Mounting position	Any								
Product weight	[g]	2.1	3.6	6	14	23	45.5	82.5	106
	S [g]	1.1	2	3	8.6	12	15	31	40
Ambient temperature [°C]	0 ... +60								
Corrosion resistance class CRC ¹⁾	2								

1) Corrosion resistance class 2 according to Festo standard 940 070
Components subject to moderate corrosion stress. Externally visible parts with primarily decorative surface requirements which are in direct contact with a normal industrial environment or media such as coolants or lubricating agents.

Energy [J]								
Size	M4	M5	M6	M8	M10	M12	M14	M16
Max. energy absorption per stroke	0.015	0.05	0.08	0.12	0.25	0.35	0.45	0.55

Mass range [kg]								
Size	M4	M5	M6	M8	M10	M12	M14	M16
Mass range up to	0.15	0.35	0.7	1	2	3	5	7

Shock absorbers DYEF- ... -Y1, without fixed stop

Technical data

Materials

Sectional view

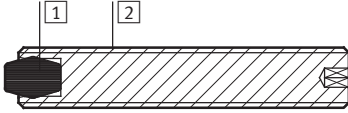

Shock absorber

1	Buffer	Nitrile rubber
2	Housing	High-alloy steel
-	Seals	Nitrile rubber
Note on materials		Free of copper, PTFE and silicone
		RoHS-compliant

Impact velocity dependent on mass m

DYEF-(S)-M4/M5-Y1

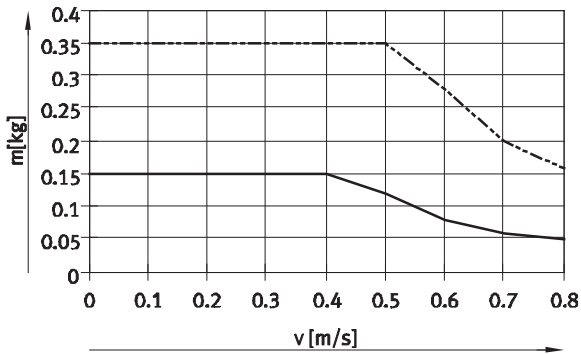

— DYEF-(S)-M4-Y1
 - - - DYEF-(S)-M5-Y1

DYEF-(S)-M6/M8/M10-Y1

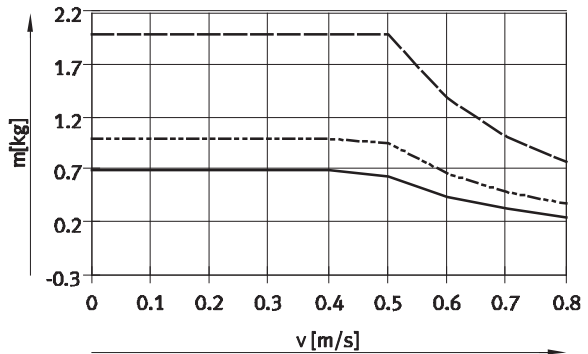

— DYEF-(S)-M6-Y1
 - - - DYEF-(S)-M8-Y1
 - · - DYEF-(S)-M10-Y1

DYEF-(S)-M12/M14/M16-Y1

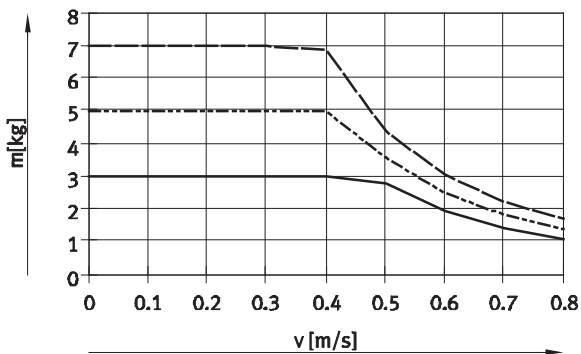

— DYEF-(S)-M12-Y1
 - - - DYEF-(S)-M14-Y1
 - · - DYEF-(S)-M16-Y1

Shock absorbers DYEF- ... -Y1, without fixed stop

Technical data

Dimensions

Download CAD data → www.festo.com

DYEF-M-... – Long version

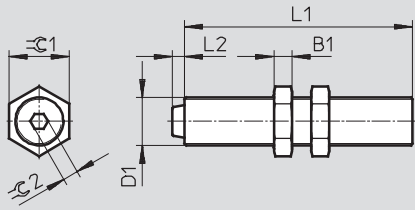

DYEF-S-M-... – Short version

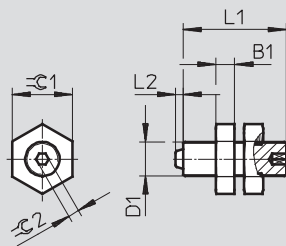

Size	B1	D1	L1		L2 +0.3	C1	C2	Max. tightening torque C1 [Nm]
			DYEF-M	DYEF-S-M				
M4	2.2	M4x0.5	22	12	0.9	7	1.3	0.5
M5	2.7	M5x0.5	26	14.5	1.8	8	1.5	0.8
M6	2.5	M6x0.5	30	15	1.8	8	2	1
M8	3	M8x1	38	23.5	2	10	2.5	2
M10	3.5	M10x1	41	21	1.8	13	3	3
M12	4	M12x1	54	20	2	15	4	5
M14	5	M14x1	72	28	2	17	4	8
M16	5	M16x1	75	31.5	2	19	5	20

Ordering data

Size	Part No.	Type
DYEF-M-... – Long version		
M4	1179810	DYEF-M4-Y1
M5	1179818	DYEF-M5-Y1
M6	1179831	DYEF-M6-Y1
M8	1179834	DYEF-M8-Y1
M10	1179837	DYEF-M10-Y1
M12	1179840	DYEF-M12-Y1
M14	1179863	DYEF-M14-Y1
M16	1179879	DYEF-M16-Y1
DYEF-S-M-... – Short version		
M4	1152500	DYEF-S-M4-Y1
M5	1152507	DYEF-S-M5-Y1
M6	1152524	DYEF-S-M6-Y1
M8	1152536	DYEF-S-M8-Y1
M10	1152959	DYEF-S-M10-Y1
M12	1153004	DYEF-S-M12-Y1
M14	1153017	DYEF-S-M14-Y1
M16	1153023	DYEF-S-M16-Y1

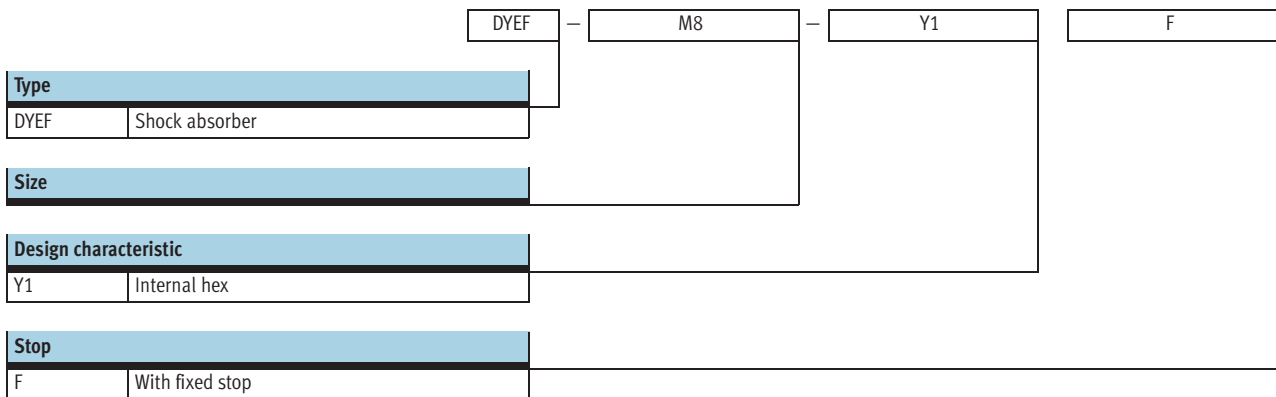

Shock absorbers DYE- ... -Y1F, with fixed stop

Type codes



Shock absorbers DYEF- ... -Y1F, with fixed stop

Technical data

-  - Size
M4 ... M22
-  - Stroke length
1.7 ... 7 mm



General technical data										
Size		M4	M5	M6	M8	M10	M12	M14	M16	M22
Stroke	[mm]	1.7	2.8	3.1	3.4	3.7	4.2	5	4.8	7
Mode of operation		Elastomer cushioning with metal fixed stop								
Cushioning		Adjustable								
Cushioning length	[mm]	1.7	2.8	3.1	3.4	3.7	4.2	5	4.8	7
Type of mounting		Via lock nut								
Max. impact velocity	[m/s]	0.8								
Mounting position		Any								
Product weight	[g]	1.6	2.9	5.1	11.9	19.7	39.6	77.3	104	200
Ambient temperature	[°C]	0 ... +60								
Corrosion resistance class CRC ¹⁾		2								

1) Corrosion resistance class 2 according to Festo standard 940 070
Components subject to moderate corrosion stress. Externally visible parts with primarily decorative surface requirements which are in direct contact with a normal industrial environment or media such as coolants or lubricating agents.

Force [N]										
Size		M4	M5	M6	M8	M10	M12	M14	M16	M22
Min. insertion force ¹⁾		15	30	40	60	70	100	150	180	500

1) This is the minimum force that must be applied so that the shock absorber is pushed precisely into the retracted end position. This value is reduced correspondingly in the event of an extended external end position or a reduction in the cushioning stroke.

Energy [J]										
Size		M4	M5	M6	M8	M10	M12	M14	M16	M22
Max. energy absorption per stroke		0.005	0.02	0.03	0.04	0.06	0.12	0.2	0.25	1.2

Mass range [kg]										
Size		M4	M5	M6	M8	M10	M12	M14	M16	M22
Mass range up to		0.15	0.25	0.4	0.6	1.2	1.8	3	5	15

Shock absorbers DYEF- ... -Y1F, with fixed stop

Technical data

FESTO

Materials

Sectional view

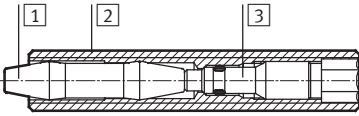

Shock absorber

1	Buffer	Nitrile rubber
2	Adjustable sleeve	Stainless steel
3	Setting piece	Stainless steel
-	Seals	Nitrile rubber
Note on materials		Free of copper, PTFE and silicone
		RoHS-compliant

Impact velocity as a function of mass m

DYEF-M4/M5-Y1F

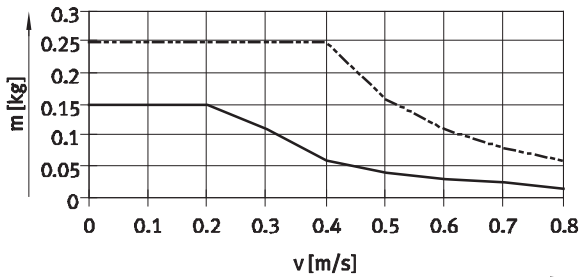

— DYEF-M4
- - - DYEF-M5

DYEF-M6/M8/M10-Y1F

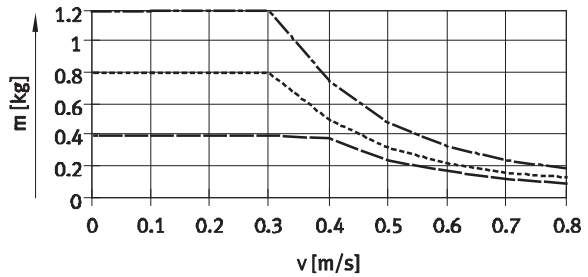

— DYEF-M6
- - - DYEF-M8
- · - · DYEF-M10

DYEF-M12/M14/M16-Y1F

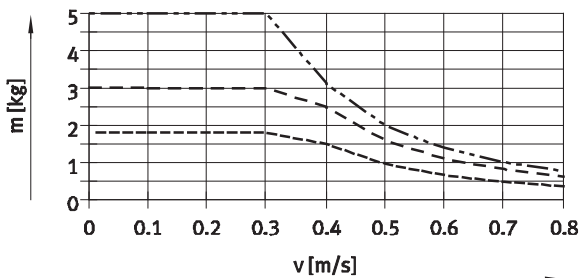

- - - DYEF-M12
- · - · DYEF-M14
· · · DYEF-M16

DYEF-M22-Y1F

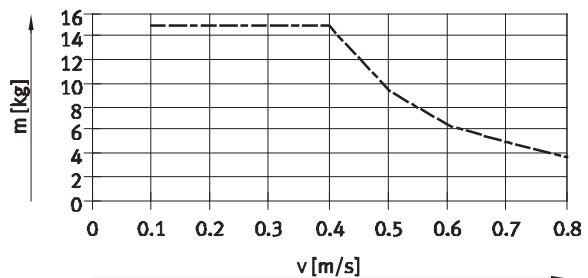

- - - DYEF-M22

Shock absorbers DYEF- ... -Y1F, with fixed stop

Technical data

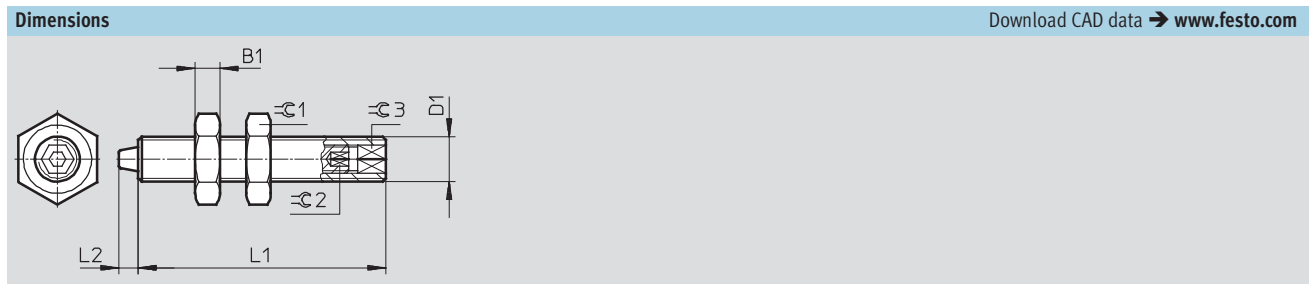

Size	B1	D1	L1	L2	∅1	∅2	∅3	Max. tightening torque ∅1 [Nm]
M4	2.2	M4x0.5	22	1.7	7	1.3	2.5	0.5
M5	2.7	M5x0.5	26	2.8	8	1.5	3	0.8
M6	2.5	M6x0.5	30	3.1	8	2	4	1
M8	3	M8x1	38	3.4	10	2.5	5	2
M10	3.5	M10x1	41	3.7	13	3	6	3
M12	4	M12x1	54	4.2	15	4	8	5
M14	5	M14x1	72	5	17	4	8	8
M16	5	M16x1	75	4.8	19	5	10	20
M22	5	M22x1.5	78	7	27	5	10	35

Ordering data

Size	Part No.	Type
M4	548370	DYEF-M4-Y1F ¹⁾
M5	548371	DYEF-M5-Y1F
M6	548372	DYEF-M6-Y1F
M8	548373	DYEF-M8-Y1F
M10	548374	DYEF-M10-Y1F
M12	548375	DYEF-M12-Y1F
M14	548376	DYEF-M14-Y1F
M16	548377	DYEF-M16-Y1F
M22	1113706	DYEF-M22-Y1F

1) The scope of delivery for this size includes an Allen key.

Shock absorbers DYSR

Peripherals overview and type codes

Peripherals overview

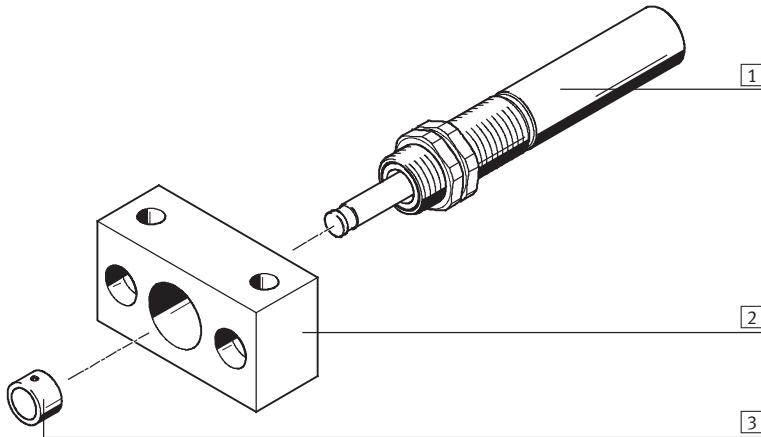

Accessories			
	Type	Brief description	→ Page/Internet
1	Shock absorber DYSR	Hydraulic shock absorber with adjustable cushioning characteristics	15
2	Mounting flange YSRF	Mounting option for shock absorber	42
3	Buffer YSRP	For protecting the piston rod	44

Type codes

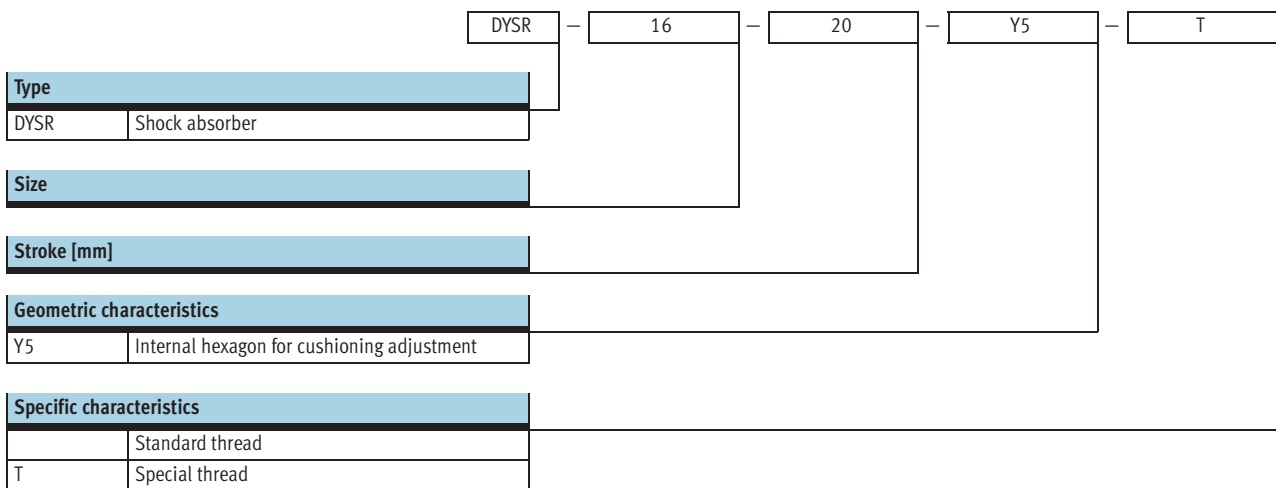



Shock absorbers DYSR

Technical data

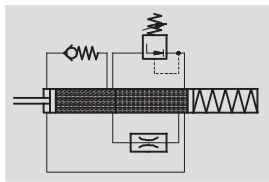
Function



-  Size
8 ... 32
-  Stroke length
8 ... 60 mm



General technical data						
Size	8	12	16	20	25	32
Stroke [mm]	8	12	20	25	40	60
Mode of operation	Hydraulic shock absorber with spring return Single acting, pushing					
Cushioning	Adjustable, force-dependent, hard characteristic curve					
Cushioning length [mm]	8	12	20	25	40	60
Type of mounting	Via lock nut					
Impact velocity [m/s]	0.1 ... 3					
Mounting position	Any					
Product weight [g]	60	105/120 ¹⁾	200/250 ¹⁾	355/425 ¹⁾	715	1,355
Ambient temperature [°C]	-10 ... +80					
Corrosion resistance class CRC ²⁾	1					

- 1) Applies to shock absorbers with special thread T
- 2) Corrosion resistance class 1 according to Festo standard 940 070
Components subject to low corrosion stress. Transport and storage protection. Parts that do not have primarily decorative surface requirements, e.g. in internal areas that are not visible or behind covers

Reset time [s]						
Size	8	12	16	20	25	32
Reset time ¹⁾	≤ 0.2		≤ 0.3		≤ 0.4	≤ 0.6

- 1) The specified technical data refers to ambient temperature. At -10 °C, the reset time can be up to 1 s for sizes 12, 16 and up to 3 s for sizes 8, 20, 25, 32

Force [N]						
Size	8	12	16	20	25	32
Min. insertion force ¹⁾	18	38	66	110	155	175
Max. stop force ²⁾ in the end positions	400	900	1,600	2,500	4,000	6,400
Min. resetting force ³⁾	1.8	4.5	5.4	9	12.5	18

- 1) This is the minimum force that must be applied so that the shock absorber is pushed precisely into the retracted end position. This value is reduced correspondingly with an extended external end position
- 2) If the maximum stop force is exceeded, a fixed stop (e.g. YSRA) must be fitted 0.5 mm before the end of stroke
- 3) This is the maximum force that can act on the piston rod, allowing for full extension of the shock absorber (e.g. protruding bolt)

Energy [J]						
Size	8	12	16	20	25	32
Max. energy absorption per stroke	4	10.8	32	62.5	160	384
Max. energy absorption per hour	24,000	60,000	100,000	135,000	220,000	330,000
Max. residual energy	0.01	0.05	0.16	0.32	0.8	2

Shock absorbers DYSR

Technical data

Materials

Sectional view

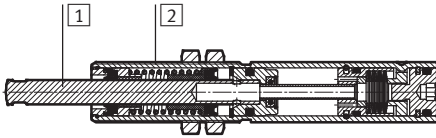

Size	8	12	16	20	25	32
1 Piston rod	High-alloy steel, hardened					
2 Housing	Nickel-plated brass			Galvanised steel		
- Buffer	Polyacetal	-				
- Seals	Nitrile rubber					
Note on materials	RoHS-compliant					

Selection graph for shock absorbers with infinitely adjustable cushioning DYSR

Impact velocity v as a function of mass m

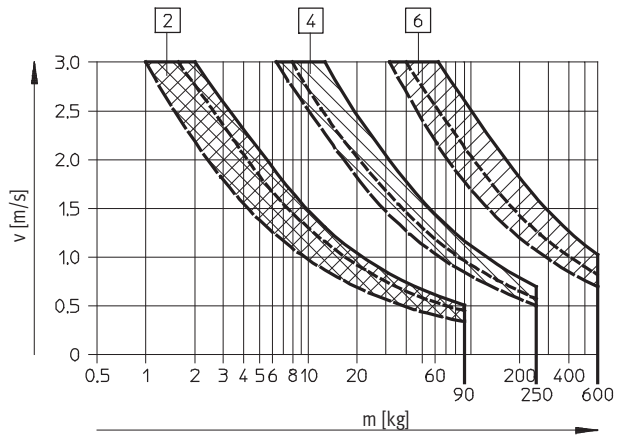
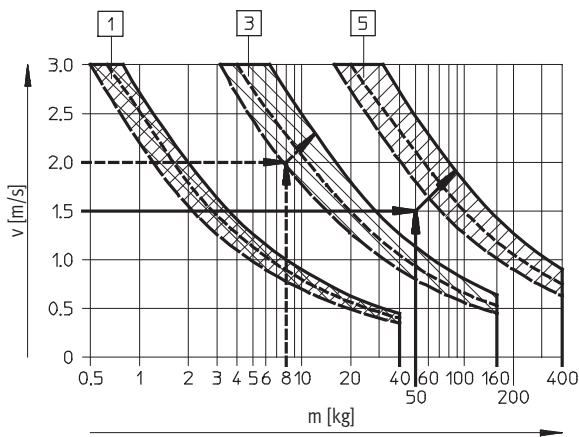

Three force curves are shown for each shock absorber. Interim values must be calculated by averaging.

The arrows relate to the examples starting on page 48.

- 1 DYSR-8-8
- 2 DYSR-12-12
- 3 DYSR-16-20
- 4 DYSR-20-25
- 5 DYSR-25-40
- 6 DYSR-32-60

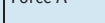
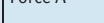
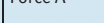
Shock absorber	Force A = 	Force A = 	Force A = 
DYSR-8-8	0 N	100 N	200 N
DYSR-12-12	0 N	200 N	500 N
DYSR-16-20	0 N	500 N	800 N
DYSR-20-25	0 N	800 N	1,200 N
DYSR-25-40	0 N	1,200 N	2,000 N
DYSR-32-60	0 N	2,000 N	3,000 N

Recommended max. motive force as a function of energy load

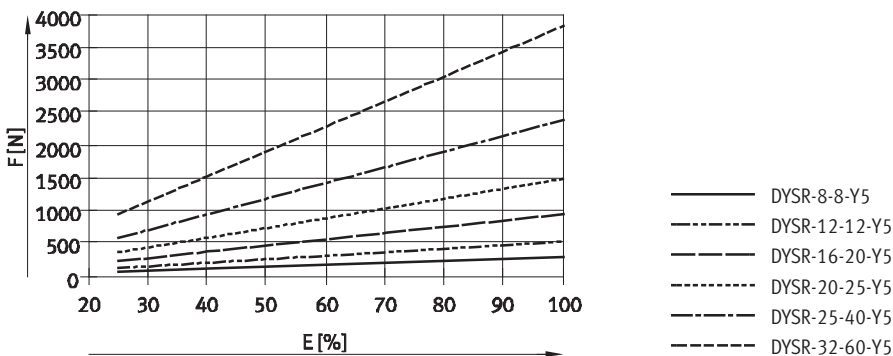

Shock absorbers DYSR

Technical data

Dimensions

DYSR-8-8

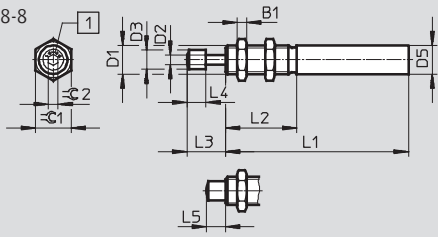

DYSR-...

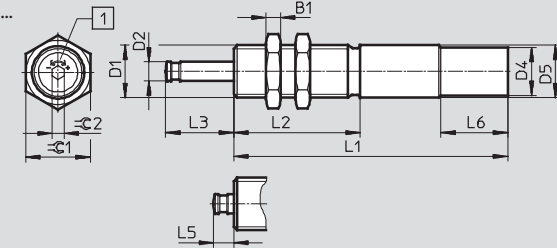

Download CAD data → www.festo.com

1 Cushioning adjustment Buffer (included in the scope of delivery)

+ = Cushioning becomes harder
- = Cushioning becomes softer



1 Cushioning adjustment Buffer YSRP (not included in the scope of delivery)

+ = Cushioning becomes harder
- = Cushioning becomes softer



Type	B1	D1	D2 Ø	D3 Ø ±0.2	D4 Ø +0.15	D5 Ø +0.15/-0.1	L1	L2 ±0.1
DYSR-8-8-Y5	4	M12x1	4	8	-	12	77±0.1	30
DYSR-12-12-Y5	5	M15x1	6	-	-	15	97±0.1	36
DYSR-12-12-Y5-T		M16x1				16		
DYSR-16-20-Y5	6	M20x1.25	8	-	-	20	115±0.1	53
DYSR-16-20-Y5-T		M22x1.5			20	22		
DYSR-20-25-Y5	8	M24x1.25	10	-	-	24	138±0.1	60
DYSR-20-25-Y5-T		M26x1.5			24	26		
DYSR-25-40-Y5	10	M30x1.5	12	-	28.8	30	178±0.1	80
DYSR-32-60-Y5	12	M37x1.5	15	-	34.8	37	230±0.15	108

Type	L3	L4 ±0.2	L5	L6 ±0.2	≅C1	≅C2	Max. tightening torque ≅C1 [Nm]
DYSR-8-8-Y5	16.2+0.6/-0.45	8	8+0.5/-0.35	-	15	4	5
DYSR-12-12-Y5	18.4+0.35/-0.2	-	6.4+0.45/-0.4	-	19	5	20
DYSR-12-12-Y5-T							
DYSR-16-20-Y5	28.5+0.4/-0.3	-	8.5+0.45/-0.4	-	24	5	35
DYSR-16-20-Y5-T		28		27			
DYSR-20-25-Y5	35.6+0.4/-0.3	-	10.6+0.45/-0.4	-	30	5	60
DYSR-20-25-Y5-T		28		32			
DYSR-25-40-Y5	52.8+0.4/-0.3	-	12.8+0.45/-0.4	28	36	6	80
DYSR-32-60-Y5	76+0.5/-0.4	-	16+0.5/-0.4	28	46	6	100

Ordering data		
Size	Part No.	Type
8	1138641	DYSR-8-8-Y5
12	1138642	DYSR-12-12-Y5
	1138643	DYSR-12-12-Y5-T
16	1138644	DYSR-16-20-Y5
	1138645	DYSR-16-20-Y5-T
20	1138646	DYSR-20-25-Y5
	1138647	DYSR-20-25-Y5-T
25	1138648	DYSR-25-40-Y5
32	1138649	DYSR-32-60-Y5

Shock absorbers YSR-C

Peripherals overview and type codes

Peripherals overview

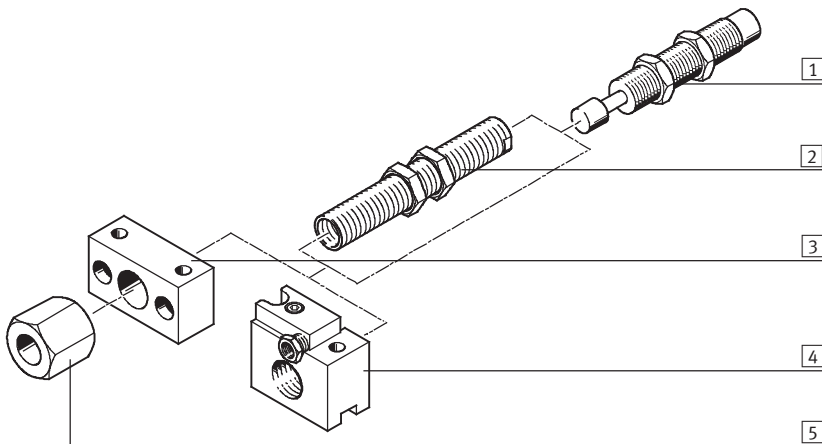

Accessories			
	Type	Brief description	→ Page/Internet
1	Shock absorber YSR-C	Hydraulic shock absorber with rapidly increasing cushioning force curve	19
2	Reducing sleeve DAYH	To improve the cushioning performance in the case of underload, the built-in shock absorber can be replaced by the next smallest shock absorber with the help of the reducing sleeve	45
3	Mounting flange YSRF	Mounting option for shock absorber	42
4	Mounting flange YSRF-S	Mounting option for shock absorber with attached stop sleeve and position sensing	43
5	Stop limiters YSRA	Stroke limiter for shock absorber	44
-	Inductive proximity sensor SIEN	For mounting flange YSRF-S	45

Type codes



	YSR	-	16	-	20	-	C
Type							
YSR	Shock absorber						
Size [mm]							
Stroke [mm]							
Cushioning function							
C	Self-adjusting						

Shock absorbers YSR-C

Technical data

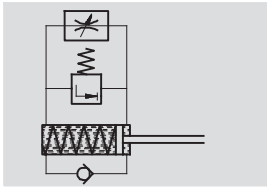
Function



-  Size
4 ... 32 mm
-  Stroke length
4 ... 60 mm



General technical data										
Size	4	5	7	8	10	12	16	20	25	32
Stroke [mm]	4	5	5	8	10	12	20	25	40	60
Mode of operation	Hydraulic shock absorbers with return spring Single acting, pushing									
Cushioning	Self-adjustable									
Cushioning length [mm]	4	5	5	8	10	12	20	25	40	60
Type of mounting	With locknut									
Impact velocity [m/s]	0.05 ... 2		0.05 ... 3							
Mounting position	Any									
Product weight [g]	5	8	16	32	51	74	185	318	600	1220
Ambient temperature [°C]	-10 ... +80									
Corrosion resistance class CRC ¹⁾	2									

- 1) Corrosion resistance class 2 to Festo standard 940 070
Components subject to moderate corrosion stress. Externally visible parts with primarily decorative surface requirements which are in direct contact with a normal industrial environment or media such as coolants or lubricating agents

Reset time [s]										
Size	4	5	7	8	10	12	16	20	25	32
Reset time ¹⁾	≤ 0.2					≤ 0.3			≤ 0.4	≤ 0.5

- 1) The specified technical data refers to ambient temperature. At higher temperatures in the 80 °C range, the max. mass and the cushioning work must be reduced by 50% approx. At -10 °C, the reset time may be up to 1 second

Forces [N]										
Size	4	5	7	8	10	12	16	20	25	32
Min. insertion force ¹⁾	6.5	7.5	10	18	25	35	60	100	140	160
Max. stop force ²⁾ in end positions	100	200	300	500	700	1,000	2,000	3,000	4,000	6,000
Min. resetting force ³⁾	0.7	0.9	1.2	2.5	3.5	5	6	10	14	20

- 1) This is the minimum force that must be applied so that the shock absorber is pushed exactly into the retracted end position. This value is reduced correspondingly in the event of an extended external end-position
2) If the max. stop force is exceeded, a fixed stop (e.g. YSRA) 0.5 mm must be fitted before the end of stroke
3) This is the maximum force which may act upon the piston rod, allowing for full extension of the shock absorber (e.g. protruding stem)

Energies [J]										
Size	4	5	7	8	10	12	16	20	25	32
Max. energy absorption per stroke	0.6	1	2	3	6	10	30	60	160	380
Max. energy absorption per hour	5,600	8,000	12,000	18,000	26,000	36,000	64,000	92,000	150,000	220,000
Max. residual energy	0.006	0.01		0.02	0.03	0.05	0.16	0.32	0.8	2

Mass range [kg]										
Size	4	5	7	8	10	12	16	20	25	32
Permissible mass range up to	1.2	1.5	5	15	25	45	90	120	200	400

Shock absorbers YSR-C

Technical data

Materials

Sectional view

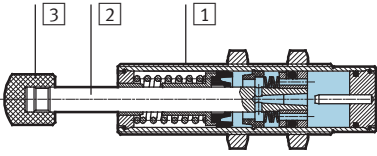

Piston Ø		4	5	7	8	10	12	16	20	25	32	
1	Housing	Brass, nickel-plated				Galvanised steel						
2	Piston rod	High-alloy steel										
3	Buffer	Polyamide									Steel with polyurethane	
-	Seals	Nitrile rubber, polyurethane										
-	Note on materials	Free of copper, PTFE and silicone									-	
		Conforms to RoHS										

Selection graph for self-adjusting shock absorbers YSR-C

Impact velocity dependent on mass m

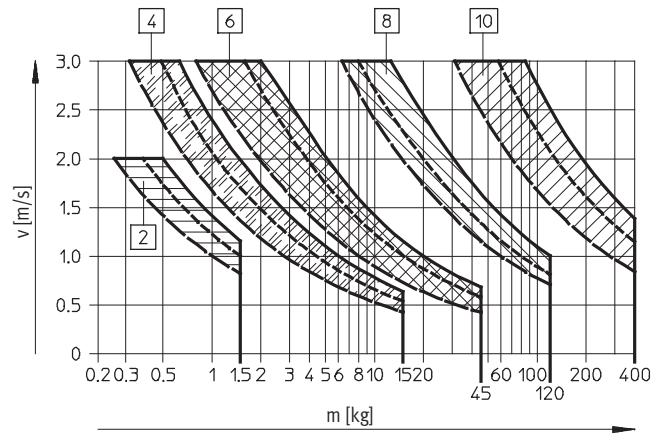
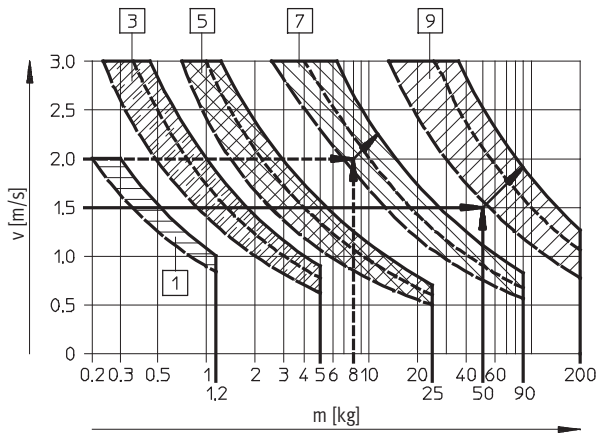

Three force curves are shown for each shock absorber. Interim values must be calculated by averaging. The

arrows relate to the examples starting on page → 49.

- 1 YSR-4-4-C
- 2 YSR-5-5-C
- 3 YSR-7-5-C
- 4 YSR-8-8-C
- 5 YSR-12-12-C
- 6 YSR-16-20-C
- 7 YSR-20-25-C
- 8 YSR-25-40-C
- 10 YSR-32-60-C

Shock absorber	Force A = —————	Force A = -----	Force A = -----
YSR-4-4-C	0 N	-	50 N
YSR-5-5-C	0 N	50 N	100 N
YSR-7-5-C	0 N	100 N	200 N
YSR-8-8-C	0 N	100 N	200 N
YSR-10-10-C	0 N	150 N	300 N
YSR-12-12-C	0 N	200 N	500 N
YSR-16-20-C	0 N	500 N	800 N
YSR-20-25-C	0 N	800 N	1,200 N
YSR-25-40-C	0 N	1,200 N	2,500 N
YSR-32-60-C	0 N	2,000 N	4,000 N

Shock absorbers YSR-C

Technical data

FESTO

Dimensions

Download CAD data → www.festo.com

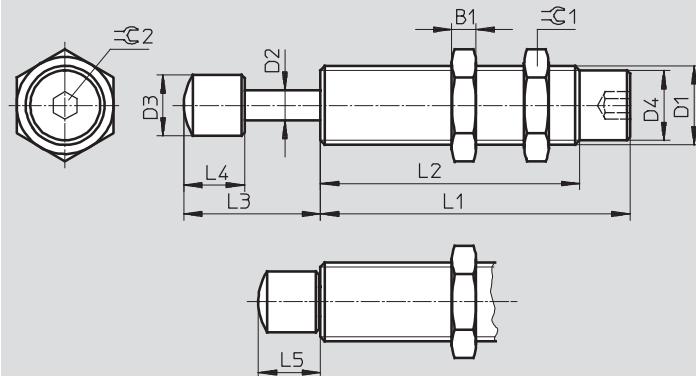

- - Note

To increase the service life:
Avoid the ingress of dirt or fluids into the piston chamber via the piston rod by, for example, using a cover.

Size	B1	D1	D2 ∅	D3 ∅	D4 ∅	L1 ±0.1
4	2,5	M6x0,5	2	3,8 ±0,1	5,3 ±0,05	28,5
5	3	M8x1	2.5	5 ±0.1	6.7 ±0.05	29
7	3.5	M10x1	3	6 ±0.1	8.6 ±0.05	34
8	4	M12x1	4	8 ±0.2	10.4 ±0.1	46
10	5	M14x1	5	10 ±0.2	12.4 ±0.1	55
12	5	M16x1	6	12 ±0.2	14.5 ±0.1	64
16	6	M22x1.5	8	16 ±0.2	19,6 ±0.1	86
20	8	M26x1.5	10	20 ±0.2	23,8 ±0.1	104
25	10	M30x1.5	12	25 ±0.2	27,8 ±0.1	152
32	12	M37x1.5	15	32 ±0.2	34,8 ±0.1	205

Size	L2	L3	L4	L5	∅C1	∅C2	Max. tightening torque ∅C1 [Nm]
4	18,5	8,3 +0,6/-0,3	4 ±0,1	4,3 +0,35/-0,25	8	2	1
5	19	10.8 +0.6/-0.3	5.5 ±0.1	5.8 +0.55/-0.25	10	-	2
7	23	12.3 +0.7/-0.35	7 ±0.2	7.3 +0.55/-0.25	13		3
8	33	16.3 +0.7/-0.35	8 ±0.2	8.3 +0.55/-0.25	15		5
10	42	20.5 +0.7/-0.35	10 ±0.2	10.5 +0.55/-0.25	17		8
12	51	24.5 +0.7/-0.35	12 ±0.2	12.5 +0.55/-0.25	19		20
16	69	36.5 +0.7/-0.35	16 ±0.2	16.5 +0.55/-0.25	27		35
20	87	45.5 +0.7/-0.35	20 ±0.2	20.5 +0.55/-0.25	32		60
25	125	61.5 +1.25/-0.75	20.5 ±0.4	21.5 +0.95/-0.55	36		80
32	179	87 +1.25/-0.75	26 ±0.4	27 +0.95/-0.55	46	100	

Ordering data

Size [mm]	Part No.	Type
4	540060	YSR-4-4-C ¹⁾
5	158981	YSR-5-5-C ¹⁾
7	160272	YSR-7-5-C ¹⁾
8	34571	YSR-8-8-C ¹⁾
10	191199	YSR-10-10-C ¹⁾
12	34572	YSR-12-12-C ¹⁾
16	34573	YSR-16-20-C ¹⁾
20	34574	YSR-20-25-C ¹⁾
25	160273	YSR-25-40-C
32	160274	YSR-32-60-C

1) Free of copper, PTFE and silicone

Shock absorbers DYSC

Peripherals overview and type codes

Peripherals overview

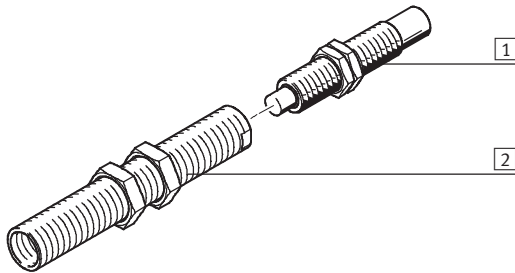

Accessories			
	Type	Brief description	→ Page/Internet
1	Shock absorber DYSC	Hydraulic shock absorber with rapidly increasing cushioning force curve	23
2	Reducing sleeve DAYH	To improve the cushioning performance in the case of underload, the built-in shock absorber can be replaced by the next smallest shock absorber with the help of the reducing sleeve	45

Type codes



	DYSC	-	8	-	8	-	Y1		F
Type									
DYSC	Shock absorber								
Size									
Stroke [mm]									
Geometric characteristic									
Y1	Internal hex								
Stop									
F	With fixed stop								

Shock absorbers DYSC

Technical data

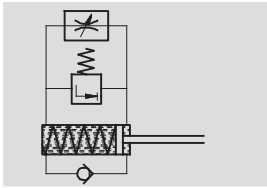
Function



-  - Size
5 ... 16
-  - Stroke length
5 ... 18 mm



General technical data					
Size	5	7	8	12	16
Stroke [mm]	5	5	8	12	18
Mode of operation	Hydraulic shock absorber with spring return Single acting, pushing				
Cushioning	Self-adjusting, hard characteristic curve				
Cushioning length [mm]	5	5	8	12	18
Type of mounting	With lock nut				
Impact velocity [m/s]	0.05 ... 2	0.05 ... 3			
Mounting position	Any				
Product weight [g]	9	17	36	81	210
Ambient temperature [°C]	-10 ... +80				
Corrosion resistance class CRC ¹⁾	2				

- 1) Corrosion resistance class 2 to Festo standard 940 070
Components subject to moderate corrosion stress. Externally visible parts with primarily decorative surface requirements which are in direct contact with a normal industrial environment or media such as coolants or lubricating agents

Reset time [s]					
Size	5	7	8	12	16
Reset time ¹⁾	≤ 0.2				≤ 0.3

- 1) The specified technical data refers to ambient temperature. At higher temperatures in the 80 °C range, the max. mass and the cushioning work must be reduced by 50% approx. At -10 °C, the reset time may be up to 1 second

Forces [N]					
Size	5	7	8	12	16
Min. insertion force ¹⁾	7.5	10	18	35	60
Max. stop force ²⁾ in end positions	200	300	500	1,000	2,000
Min. resetting force ³⁾	0.9	1.2	2.5	5	6

- 1) This is the minimum force that must be applied so that the shock absorber is pushed exactly into the retracted end position. This value is reduced correspondingly in the event of an extended external end position
2) If the max. stop force is exceeded, a fixed stop (e.g. YSRA) 0.5 mm must be fitted before the end of stroke
3) This is the maximum force which may act upon the piston rod, allowing for full extension of the shock absorber (e.g. protruding stem)

Energies [J]					
Size	5	7	8	12	16
Max. energy absorption per stroke	1	2	3	10	25
Max. energy absorption per hour	8,000	12,000	18,000	36,000	50,000
Max. residual energy	0.01		0.02	0.05	0.16

Mass range [kg]					
Size	5	7	8	12	16
Mass range up to	1.5	5	15	45	70

Shock absorbers DYSC

Technical data

Materials

Sectional view

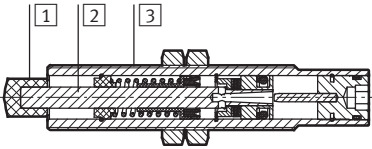

Size	5	7	8	12	16
1 Buffer	Polyacetate				
2 Piston rod	High-alloy steel				
3 Housing	Brass, nickel-plated			Galvanised steel	
- Seals	Nitrile rubber				
Note on materials	Copper, PTFE and silicone-free Conforms to RoHS				

Selection graph for self-adjusting shock absorbers DYSC

Impact velocity dependent on mass m

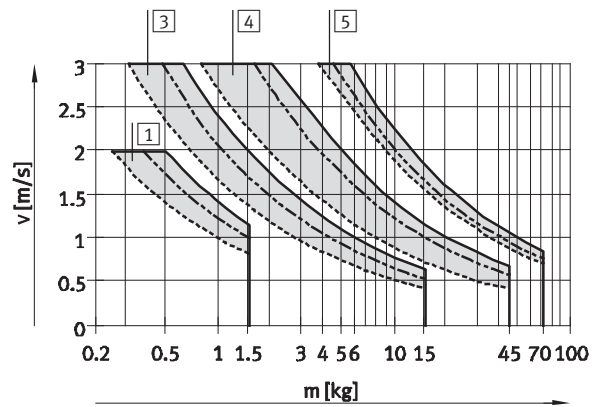
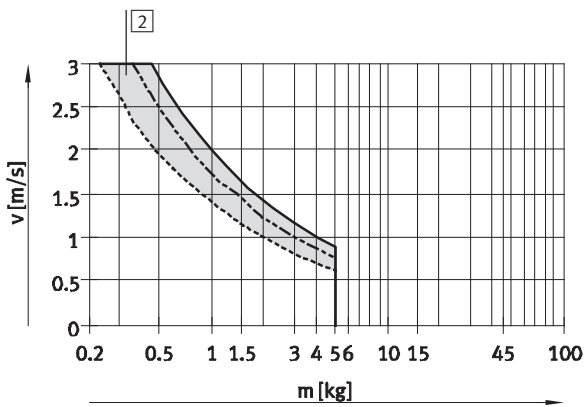

Three force curves are shown for each shock absorber. Interim values must be calculated by averaging.

- 1 DYSC-5-5-Y1F
- 2 DYSC-7-5-Y1F

- 3 DYSC-8-8-Y1F
- 4 DYSC-12-12-Y1F

- 5 DYSC-16-18-Y1F

Shock absorber	Force A = —————	Force A = -----	Force A = -----
DYSC-5-5-Y1F	0 N	50 N	100 N
DYSC-7-5-Y1F	0 N	100 N	200 N
DYSC-8-8-Y1F	0 N	100 N	200 N
DYSC-12-12-Y1F	0 N	200 N	500 N
DYSC-16-18-Y1F	0 N	500 N	800 N

Shock absorbers DYSC

Technical data

Dimensions

Download CAD data → www.festo.com

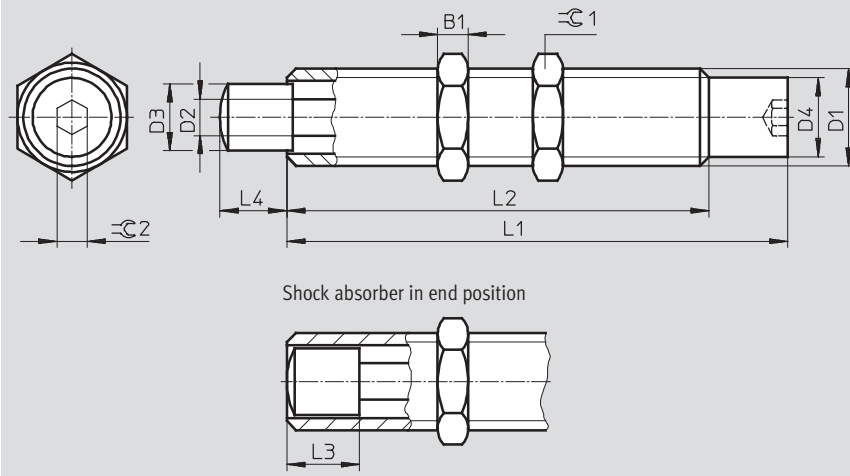

- - Note

To increase the service life:
Avoid the ingress of dirt or fluids into the piston chamber via the piston rod by, for example, using a cover.

Size [mm]	B1	D1	D2 ∅	D3 ∅	D4 ∅	L1 ±0.1	L2 +0.3/-0.2
5	3	M8x1	2.5	4.7 ±0.05	6.7 ±0.05	38.6	28.4
7	3.5	M10x1	3	6 ±0.1	8.6 ±0.05	45.15	34.15
8	4	M12x1	4	7 ±0.1	10.4 ±0.1	59.05	46.05
12	5	M16x1	6	11 ±0.1	14.5 ±0.1	82.5	69.5
16	6	M22x1.5	8	15 ±0.1	19.6 ±0.1	110	93

Size [mm]	L3 ¹⁾	L4	≡C1	≡C2	Max. tightening torque ≡C1 [Nm]
5	5.5	5 +0.32/-0.28	10	2.5	2
7	7	5 +0.37/-0.28	13	3	3
8	8	8 +0.42/-0.33	15	4	5
12	12	12 +0.50/-0.35	19	5	20
16	17	18 +0.50/-0.35	27	5	35

1) Buffer length

Ordering data

Size [mm]	Part No.	Type
5	548011	DYSC-5-5-Y1F
7	548012	DYSC-7-5-Y1F
8	548013	DYSC-8-8-Y1F
12	548014	DYSC-12-12-Y1F
16	553593	DYSC-16-18-Y1F

Shock absorbers YSRW

Peripherals overview and type codes

Peripherals overview

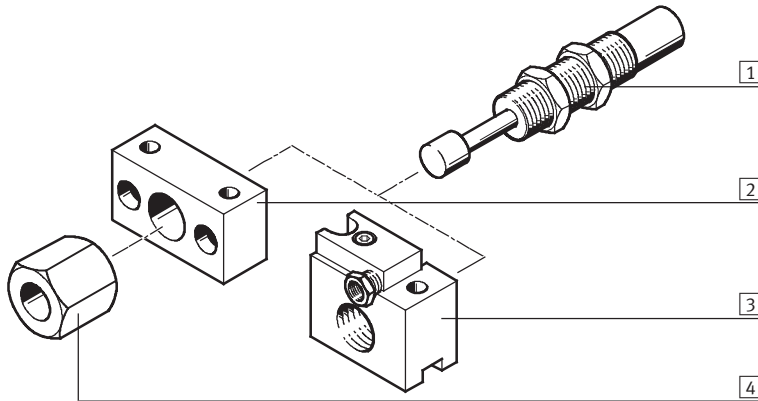

Accessories			
	Type	Brief description	→ Page/Internet
1	Shock absorber YSRW	Hydraulic shock absorber with progressive cushioning characteristic	27
2	Mounting flange YSRF	Mounting option for shock absorber	42
3	Mounting flange YSRF-S	Mounting option for shock absorber with attached stop sleeve and position sensing	43
4	Stop limiters YSRA	Stroke limiter for shock absorber	44
-	Inductive proximity sensor SIEN	For mounting flange YSRF-S	45

Type codes



	YSRW	-	10	-	20
Type					
YSRW	Shock absorber				
Size					
Stroke [mm]					

Shock absorbers YSRW

Technical data

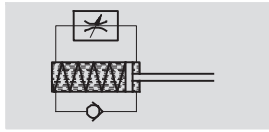
Function



-  Size
5 ... 20 mm
-  Stroke length
8 ... 34 mm



General technical data							
Size	5	7	8	10	12	16	20
Stroke [mm]	8	10	14	17	20	26	34
Mode of operation	Hydraulic shock absorbers with return spring						
	Single acting, pushing						
Cushioning	Self-adjustable						
Cushioning length [mm]	8	10	14	17	20	26	34
Type of mounting	With locknut						
Impact velocity [m/s]	0.1 ... 2		0.1 ... 3				
Mounting position	Any						
Product weight [g]	8	18	34	54	78	190	330
Ambient temperature [°C]	-10 ... +80						
Corrosion resistance class CRC ¹⁾	2						

- 1) Corrosion resistance class 2 to Festo standard 940 070
Components subject to moderate corrosion stress. Externally visible parts with primarily decorative surface requirements which are in direct contact with a normal industrial environment or media such as coolants or lubricating agents

Reset time [s]							
Size	5	7	8	10	12	16	20
Reset time ¹⁾	≤ 0.2				≤ 0.3		

- 1) The specified technical data refers to ambient temperature. At higher temperatures in the 80 °C range, the max. mass and the cushioning work must be reduced by 50% approx. At -10 °C, the reset time may be up to 1 second

Forces [N]							
Size	5	7	8	10	12	16	20
Min. insertion force ¹⁾	7.5	10	18	25	35	60	100
Max. stop force ²⁾ in end positions	200	300	500	700	1,000	2,000	3,000
Min. resetting force ³⁾	0.9	1.2	2.5	3.5	5	6	10

- 1) This is the minimum force that must be applied so that the shock absorber is pushed exactly into the retracted end position. This value is reduced correspondingly in the event of an extended external end-position
2) If the max. stop force is exceeded, a fixed stop (e.g. YSRA) 0.5 mm must be fitted before the end of stroke
3) This is the maximum force which may act upon the piston rod, allowing for full extension of the shock absorber (e.g. protruding stem)

Energies [J]							
Size	5	7	8	10	12	16	20
Max. energy absorption per stroke	1.3	2.5	4	8	12	35	70
Max. energy absorption per hour	10,000	15,000	21,000	30,000	41,000	68,000	100,000
Max. residual energy	0.01		0.02	0.03	0.05	0.16	0.32

Mass range [kg]							
Size	5	7	8	10	12	16	20
Permissible mass range up to	2	5	10	20	30	50	80

Shock absorbers YSRW

Technical data

FESTO

Materials

Sectional view

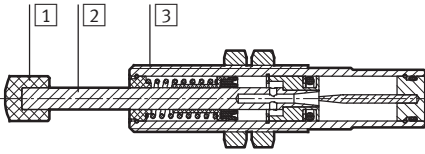

Size	5	7	8	10	12	16	20
1 Buffer	Polyamide						
2 Piston rod	High-alloy steel						
3 Housing	Brass, nickel-plated			Galvanised steel			
- Seals	Nitrile rubber						
Note on materials	Free of copper, PTFE and silicone						
	Conforms to RoHS						

Selection graph for self-adjusting shock absorbers with progressive characteristics YSRW

Impact velocity dependent on mass m

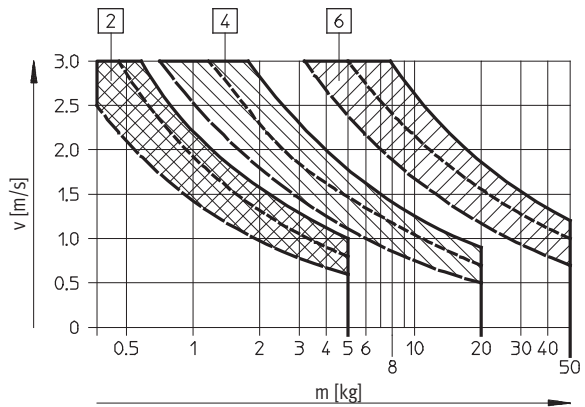
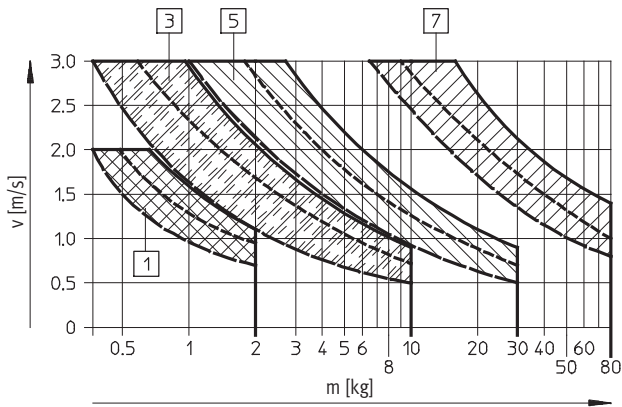

Three force curves are shown for each shock absorber. Interim values must be calculated by averaging.

- 1 YSRW-5-8
- 2 YSRW-7-10
- 3 YSRW-8-14
- 4 YSRW-10-17

- 5 YSRW-12-20
- 6 YSRW-16-26
- 7 YSRW-20-34

Shock absorber	Force A = <u> </u>	Force A = <u> </u>	Force A = <u> </u>
YSRW-5-8	0 N	50 N	100 N
YSRW-7-10	0 N	75 N	150 N
YSRW-8-14	0 N	100 N	200 N
YSRW-10-17	0 N	150 N	300 N
YSRW-12-20	0 N	200 N	400 N
YSRW-16-26	0 N	500 N	800 N
YSRW-20-34	0 N	800 N	1,200 N

Shock absorbers YSRW

Technical data

FESTO

Dimensions

Download CAD data → www.festo.com

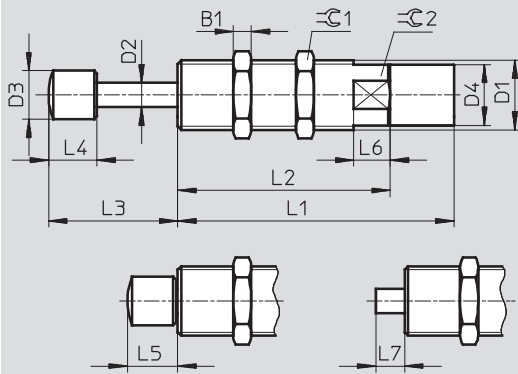

 Note

To increase the service life:
Avoid the ingress of dirt or fluids into the piston chamber via the piston rod by, for example, using a cover.

Size	B1	D1	D2 ∅	D3 ∅	D4 ∅	L1 ±0.1	L2 ±0.3	L3
5	3	M8x1	2.5	5 ±0.1	6.7 ±0.05	33.5	22.5	13.8 +0.6/-0.25
7	3.5	M10x1	3	6 ±0.1	8.6 ±0.05	41	30	17.3 +0.7/-0.25
8	4	M12x1	4	8 ±0.2	10.4 ±0.1	53	40	22.3 +0.7/-0.25
10	5	M14x1	5	10 ±0.2	12.4 ±0.1	62	49	27.5 +0.7/-0.25
12	5	M16x1	6	12 ±0.2	14.5 ±0.1	72.5	59.5	32.5 +0.7/-0.25
16	6	M22x1.5	8	16 ±0.2	20 ±0.1	91	70	42.5 +0.7/-0.35
20	8	M26x1.5	10	20 ±0.2	24 ±0.1	112	91	54.5 +0.7/-0.35

Size	L4	L5	L6 +0.5	L7	⊖C1	⊖C2	Max. tightening torque ⊖C1 [Nm]
5	5.5 ±0.1	5.8 +0.35/-0.25	5	3.5 ±0.25	10	7	2
7	7 ±0.2	7.3 +0.35/-0.25	6	4.3 ±0.25	13	9	3
8	8 ±0.2	8.3 +0.4/-0.25	8	5.3 +0.3/-0.25	15	11	5
10	10 ±0.2	10.5 +0.4/-0.25	10	6.5 +0.3/-0.25	17	13	8
12	12 ±0.2	12.5 +0.4/-0.25	12	7.5 +0.3/-0.25	19	15	20
16	16 ±0.2	16.5 +0.4/-0.25	12	9.5 +0.3/-0.25	27	20	35
20	20 ±0.2	20.5 +0.4/-0.25	12	11.5 +0.3/-0.25	32	24	60

Ordering data

Size [mm]	Part No.	Type
5	191192	YSRW-5-8
7	191193	YSRW-7-10
8	191194	YSRW-8-14
10	191195	YSRW-10-17
12	191196	YSRW-12-20
16	191197	YSRW-16-26
20	191198	YSRW-20-34

Shock absorbers DYSW

Peripherals overview and type codes

Peripherals overview

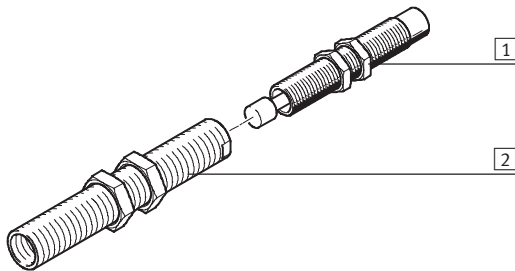

Accessories			
	Type	Brief description	→ Page/Internet
1	Shock absorber DYSW	Hydraulic shock absorber with rapidly increasing cushioning force curve	31
2	Reducing sleeve DAYH	To improve the cushioning performance in the case of underload, the built-in shock absorber can be replaced by the next smallest shock absorber with the help of the reducing sleeve	45

Type codes



	DYSW	-	8	-	14	-	Y1		F
Type									
DYSW	Shock absorber								
Size									
Stroke [mm]									
Additional feature									
Y1	Internal hex								
Stop									
F	With fixed stop								

Shock absorbers DYSW

Technical data

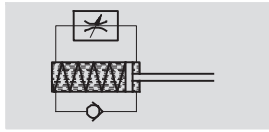
Function



-  Size
4 ... 12
-  Stroke length
6 ... 20 mm



General technical data						
Size	4	5	7	8	10	12
Stroke [mm]	6	8	10	14	17	20
Mode of operation	Hydraulic shock absorber with spring return Single acting, pushing					
Cushioning	Self-adjusting, soft characteristic curve					
Cushioning length [mm]	6	8	10	14	17	20
Type of mounting	With lock nut					
Impact velocity [m/s]	0.1 ... 2		0.1 ... 3			
Assembly position	Any					
Product weight [g]	6	11	21	42	67	91
Ambient temperature [°C]	-10 ... +80					

Reset time [s]						
Size	4	5	7	8	10	12
Reset time ¹⁾	≤ 0.2					≤ 0.3

1) The specified technical data refers to ambient temperature. At higher temperatures in the 80 °C range, the max. mass and the cushioning work must be reduced by 50% approx. At -10 °C, the reset time may be up to 1 second

Forces [N]						
Size	4	5	7	8	10	12
Min. insertion force ¹⁾	6.5	7.5	10	18	25	35
Max. stop force ²⁾ in end positions (housing)	100	200	300	500	700	1,000
Min. resetting force ³⁾	0.7	0.9	1.2	2.5	3.5	5

- 1) This is the minimum force that must be applied so that the shock absorber is pushed exactly into the retracted end position. This value is reduced correspondingly in the event of an extended external end position
- 2) If the max. stop force is exceeded, a fixed stop (e.g. YSRA) 0.5 mm must be fitted before the end of stroke
- 3) This is the maximum force which may act upon the piston rod, allowing for full extension of the shock absorber (e.g. protruding stem)

Energies [J]						
Size	4	5	7	8	10	12
Max. energy absorption per stroke	0.8	1.3	2.5	4	8	12
Max. energy absorption per hour	7,000	10,000	15,000	21,000	30,000	41,000
Max. residual energy	0.006	0.01	0.01	0.02	0.03	0.05

Mass range [kg]						
Size	4	5	7	8	10	12
Mass range up to	1.2	2	5	10	20	30

Shock absorbers DYSW

Technical data

FESTO

Materials

Sectional view

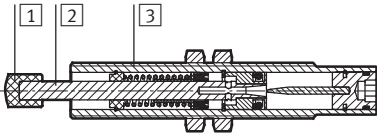

Size	4	5	7	8	10	12
1 Buffer	Polyacetate					
2 Piston rod	High-alloy steel					
3 Housing	Brass, nickel-plated		High-alloy steel		Galvanised steel	
- Seals	Nitrile rubber					
Note on materials	Free of copper, PTFE and silicone					
	Conforms to RoHS					

Selection graph for self-adjusting shock absorbers with progressive characteristics DYSW

Impact velocity dependent on mass m

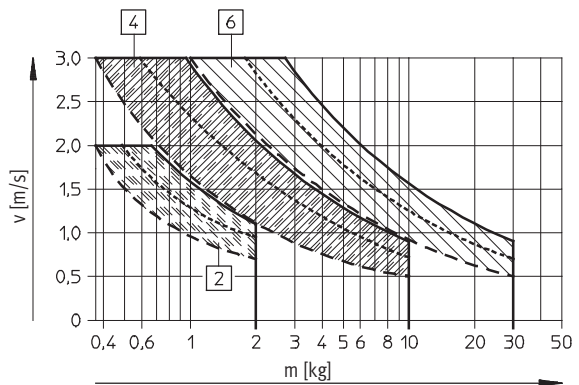
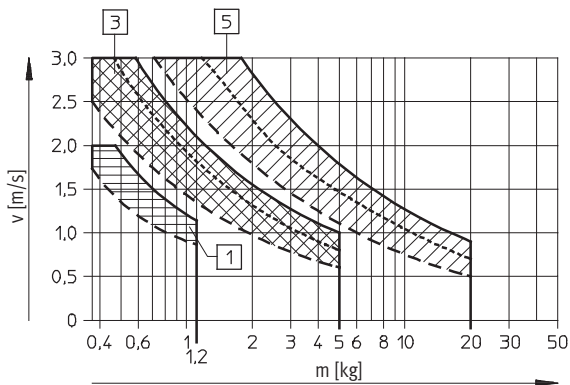

Three force curves are shown for each shock absorber. Interim values must be calculated by averaging.

1 DYSW-4-6-Y1F
2 DYSW-5-8-Y1F
3 DYSW-7-10-Y1F

4 DYSW-8-14-Y1F
5 DYSW-10-17-Y1F
6 DYSW-12-20-Y1F

Shock absorber	Force A = —————	Force A = -----	Force A = -----
DYSW-4-6-Y1F	0 N	-	50 N
DYSW-5-8-Y1F	0 N	50 N	100 N
DYSW-7-10-Y1F	0 N	75 N	150 N
DYSW-8-14-Y1F	0 N	100 N	200 N
DYSW-10-17-Y1F	0 N	150 N	300 N
DYSW-12-20-Y1F	0 N	200 N	400 N

Shock absorbers DYSW

Technical data

FESTO

Dimensions

Download CAD data → www.festo.com

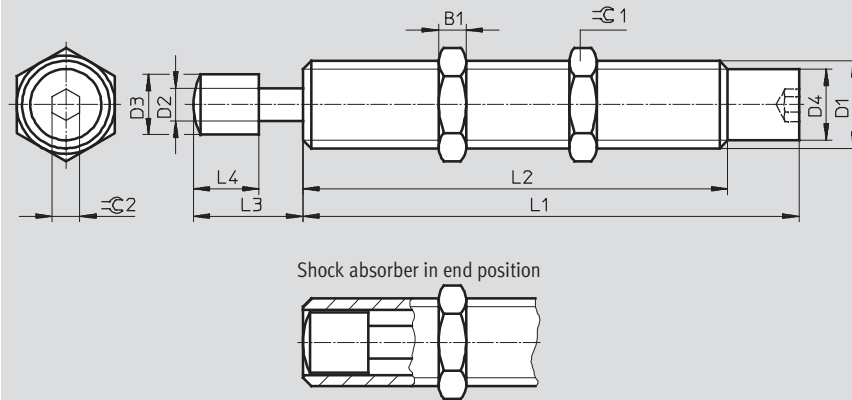

- - Note

To increase the service life:
Avoid the ingress of dirt or fluids into the piston chamber via the piston rod by, for example, using a cover.

Size	B1	D1	D2 Ø	D3 Ø	D4 Ø	L1
[mm]						+0.1
4	2.5	M6x0.5	2	3.5±0.05	5.35±0.05	35.5
5	3	M8x1	2.5	4.7±0.05	6.7±0.05	43.1
7	3.5	M10x1	3	6±0.1	8.6±0.05	52.05
8	4	M12x1	4	7±0.1	10.4±0.1	66.05
10	5	M14x1	5	9±0.1	12.4±0.1	77.55
12	5	M16x1	6	11±0.1	14.4±0.1	90.75

Size	L2 +0.3 -0.2	L3	L4	⌀C1	⌀C2	Max. tightening torque ⌀C1 [Nm]
[mm]						
4	25.5	6+0.30/-0.24	4±0.05	8	2	1
5	33.1	8+0.32/-0.28	5.5±0.1	10	2.5	2
7	41.05	10+0.37/-0.28	7±0.2	13	3	3
8	53.05	14+0.37/-0.28	8±0.2	15	4	5
10	64.55	17+0.37/-0.28	10±0.2	17	4	8
12	77.75	20+0.45/-0.30	12±0.2	19	5	20

Ordering data

Size [mm]	Part No.	Type
4	548070	DYSW-4-6-Y1F
5	548071	DYSW-5-8-Y1F
7	548072	DYSW-7-10-Y1F
8	548073	DYSW-8-14-Y1F
10	548074	DYSW-10-17-Y1F
12	548075	DYSW-12-20-Y1F

Stop elements YSRWJ

Peripherals overview and type codes

Peripherals overview

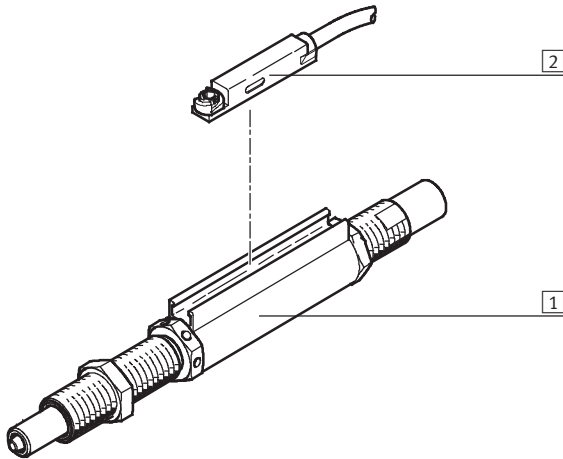

Accessories			
	Type	Brief description	→ Page/Internet
1	Stop element YSRWJ	Hydraulic shock absorber with progressive cushioning characteristic. The cushioning length is adjustable	35
2	Proximity switches SME-/SMT-8	Sensing option for end positions	45

Type codes

		YSRWJ	-	7	-	10	-	A
Type								
YSRWJ	Shock absorber							
Size								
Stroke [mm]								
Position sensing								
A	Position sensing							



Stop elements YSRWJ

Technical data

FESTO

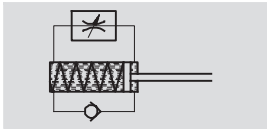
Function



-  Size
5 ... 8 mm
-  Stroke length
7.5 ... 13.5 mm



General technical data			
Size	5	7	8
Stroke [mm]	8	10	14
Mode of operation	A piston rod in front of the shock absorber transmits the force to the shock absorber. This serves as the end stop and actuates the proximity sensor via a magnet mounted on it		
	Single acting, pushing		
Cushioning	Self-adjustable		
Cushioning length [mm]	8	10	14
Type of mounting	With locknut		
Position sensing	Via proximity sensor		
Impact velocity [m/s]	0.05 ... 2	0.05 ... 3	
Repetition accuracy [mm]	0.02		
Mounting position	Any		
Product weight [g]	45	75	110
Ambient temperature [°C]	0 ... +60		
Corrosion resistance class CRC ¹⁾	2		

- 1) Corrosion resistance class 2 to Festo standard 940 070
Components subject to moderate corrosion stress. Externally visible parts with primarily decorative surface requirements which are in direct contact with a normal industrial environment or media such as coolants or lubricating agents

Reset time [s]			
Size	5	7	8
Reset time ¹⁾	≤ 0.2		

- 1) The specified technical data refers to ambient temperature. At higher temperatures in the 80 °C range, the max. mass and the cushioning work must be reduced by 50% approx.
At 0 °C, the reset time may be up to 1 second

Forces [N]			
Size	5	7	8
Min. insertion force ¹⁾	5	18	80
Max. stop force ²⁾ in end positions	200	300	500
Min. resetting force ³⁾	1.5	2	3.5

- 1) This is the minimum force that must be applied so that the shock absorber is pushed exactly into the retracted end position
2) Impact force may not exceed the maximum specified value
3) This is maximum force that can be exerted on the piston rod so that the shock absorber advances fully

Energies [J]			
Size	5	7	8
Max. energy absorption per stroke	1	2	3
Max. energy absorption per hour	10,000	15,000	21,000
Max. residual energy	0.01	0.02	

Mass range [kg]			
Size	5	7	8
Permissible mass range up to	2	5	10

Stop elements YSRWJ

Technical data

Materials

Sectional view

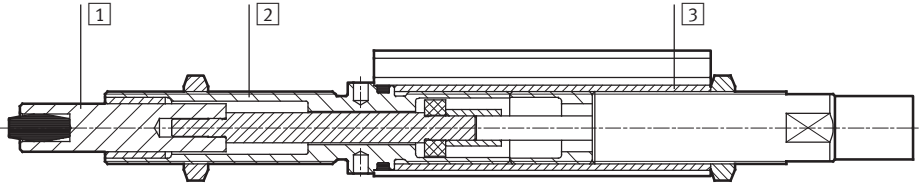

Stop element

1	Stop bolt	Steel, stainless and reinforced
2	Distance sleeve	Galvanised steel
3	Threaded barrel	Brass, nickel-plated
-	Note on materials	Free of copper, PTFE and silicone Conforms to RoHS

Selection graphs for limit stops with shock absorber YSRWJ

Impact velocity dependent on mass m

YSRWJ-5-8-A

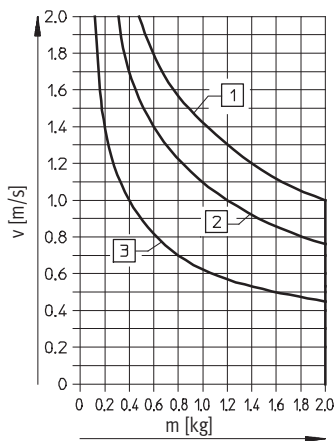

- 1 Without additional force
- 2 With additional force A = 50 N
- 3 With additional force A = 100 N

YSRWJ-7-10-A

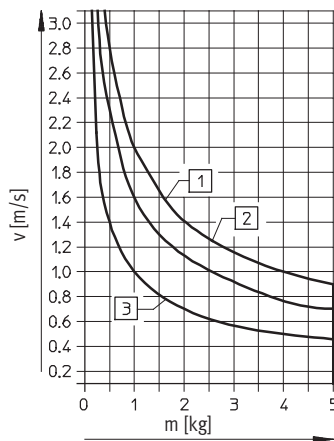

- 1 Without additional force
- 2 With additional force A = 75 N
- 3 With additional force A = 150 N

YSRWJ-8-14-A

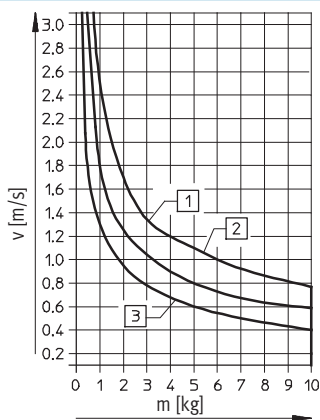

- 1 Without additional force
- 2 With additional force A = 100 N
- 3 With additional force A = 150 N

Stop elements YSRWJ

Technical data

FESTO

Mode of operation

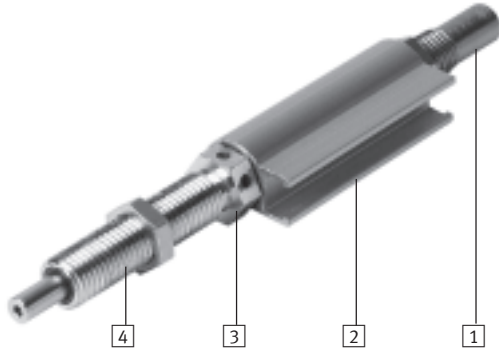

- 1 Soft cushioning characteristics – cushioning stroke is adjustable
- 2 End-position sensing via proximity sensor SME-/SMT-8 that can be integrated
- 3 Precision end-position adjustment
- 4 Precision end position thanks to internal, metallic inserts

Dimensions

Download CAD data → www.festo.com

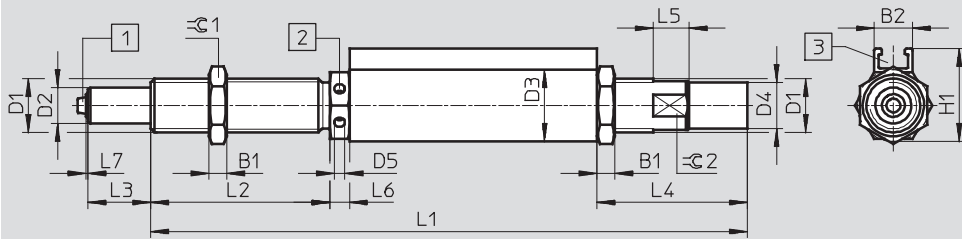

- 1 Rubber buffer, only with sizes: YSRWJ-7-10-A and YSRWJ-8-14-A
- 2 Precision end-position adjustment
- 3 Slot for proximity sensor SME-/SMT-8

Size	B1	B2	D1	D2	D3	D4	D5	H1	L1
[mm]		+0.4			+0.1		+0.1	+0.3	+0.3/-0.1
5	3	8.1	M8x1	4	12	6.7 ±0.05	2	16.5	97.4
7	3.5	8.5	M10x1	6	14	8.6 ±0.05	2.4	18.3	144.8
8	4	8.5	M12x1	8	16	10.4 ±0.1	2.4	20.75	133.3

Size	L2	L3	L4	L5	L6	L7	⌀C1	⌀C2	Max. tightening torque ⌀C1 [Nm]
[mm]	+0.4		+0.45/-0.1	+0.5	+0.1/-0.55	+0.3			
5	32.5	8 +0.7/-0.55	21.6	5	4.4	0.5	10	7	2
7	40	10 +0.8/-0.55	21.1	6	4	0.5	13	9	3
8	40	14 +0.8/-0.55	33.6	8	4.4	0.5	15	11	5

Ordering data

Size [mm]	Part No.	Type
5	192968	YSRWJ-5-8-A
7	192967	YSRWJ-7-10-A
8	192966	YSRWJ-8-14-A

Hydraulic cushioning cylinders DYHR

Peripherals overview and type codes

Peripherals overview

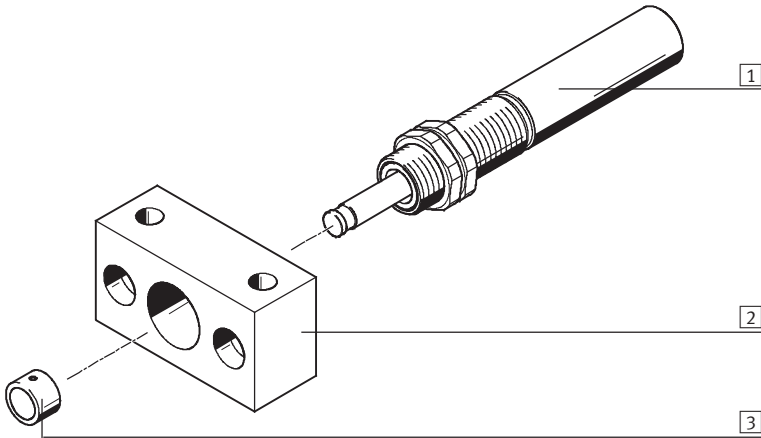

Accessories			
	Type	Brief description	→ Page/Internet
1	Hydraulic cushioning cylinder DYHR	Hydraulic cushioning cylinder with spring return for slow feed speeds	39
2	Mounting flange YSRF	Mounting option for hydraulic cushioning cylinder	42
3	Buffer YSRP	For protecting the piston rod	44

Type codes



		DYHR	-	16	-	20	-	Y5
Type								
DYHR	Hydraulic cushioning cylinder							
Size								
Stroke [mm]								
Design characteristic								
Y5	Internal hex for setting the flow control valve							

Hydraulic cushioning cylinders DYHR

Technical data

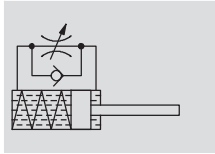
Function



-  - Size
16 ... 32
-  - Stroke length
20 ... 60 mm



General technical data							
Size	16		20		25	32	
Stroke [mm]	20	40	25	50	40	60	
Mode of operation	Hydraulic cushioning cylinder with spring return						
	Single-acting, pushing						
Braking speed	Adjustable						
Type of mounting	Via lock nut						
Max. impact velocity [m/s]	0.3						
Mounting position	Any						
Feed speed [mm/s]	0.2 ... 100						
Product weight [g]	190	255	360	440	720	1,380	
Ambient temperature [°C]	0 ... +80						
Corrosion resistance class CRC ¹⁾	1						

- 1) Corrosion resistance class 1 according to Festo standard 940 070
Components subject to low corrosion stress. Transport and storage protection. Parts that do not have primarily decorative surface requirements, e.g. in internal areas that are not visible or behind covers

Reset times [s]				
Size	16	20	25	32
Short stroke ¹⁾	≤ 0.4	≤ 0.5	≤ 0.8	≤ 1.2
Long stroke ¹⁾	≤ 0.8	≤ 1	-	-

- 1) Increased reset times must be expected at low temperatures (0 °C). Up to 5 s with sizes 12 and 16 and up to 12 s with sizes 25 and 32.

Forces [N]				
Size	16	20	25	32
Min. feed force ¹⁾	160	250	400	640
Max. feed force ²⁾	1,600	2,500	4,000	6,400
Resetting force ³⁾	5.4	9	12.5	18

- 1) Min. required force for constant braking speed with repetition accuracy
2) Corresponds to max. force in the end position
3) With piston rod advanced

Energies [J]						
Size	16		20		25	32
Stroke [mm]	20	40	25	50	40	60
Max. energy absorption per stroke	32	64	62.5	125	160	384
Max. energy absorption per hour	100,000	150,000	135,000	200,000	220,000	330,000
Max. residual energy in the end position	0.16		0.32		0.8	2

Hydraulic cushioning cylinders DYHR

Technical data

Materials

Sectional view

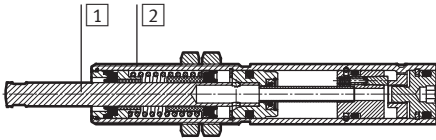

Hydraulic cushioning cylinder

1	Piston rod	Hardened high-alloy steel
2	Housing	Galvanised steel
-	Seals	Nitrile rubber
Note on materials		RoHS-compliant

Braking speed v as a function of motive force F and flow control valve setting

DYHR-16

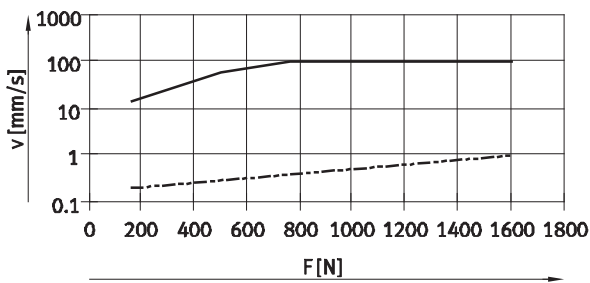

DYHR-20

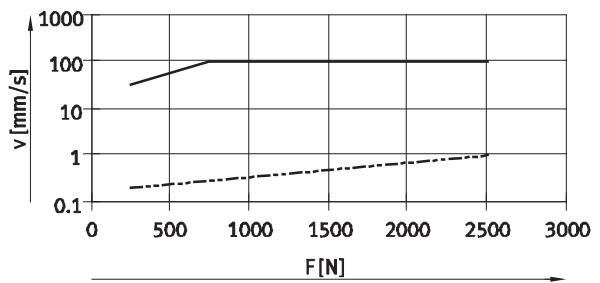

DYHR-25

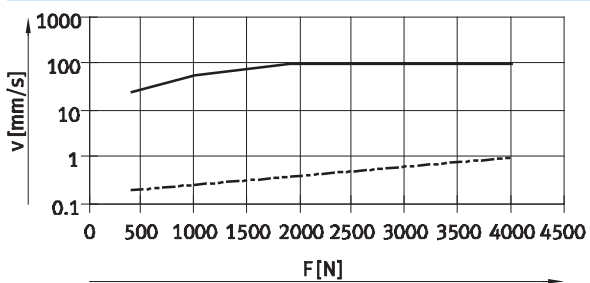

DYHR-32

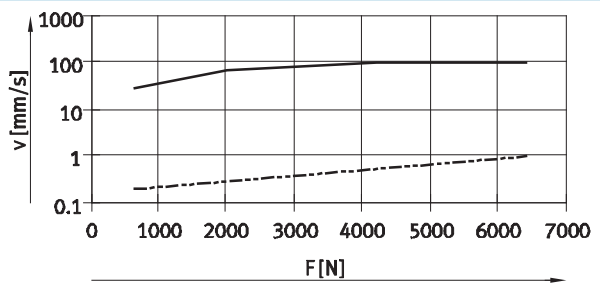

— Flow control valve open
 - - - - - Flow control valve closed

Hydraulic cushioning cylinders DYHR

Technical data

Dimensions

Download CAD data → www.festo.com

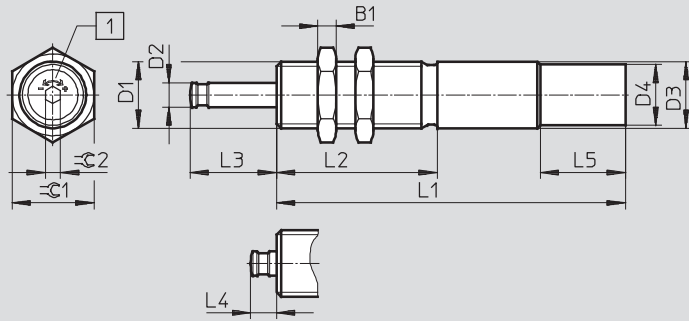

+ = Braking speed becomes harder
 - = Braking speed becomes softer



1 Speed control

Size	Stroke [mm]	B1	D1	D2 ∅	D3 ∅ +0.15/-0.1	D4 ∅ +0.15	L1
16	20	6	M20x1.25	8	20	-	115±0.1
	40						150±0.1
20	25	8	M24x1.25	10	24	-	138±0.1
	50						181±0.1
25	40	10	M30x1.5	12	30	28.8	178±0.1
32	60	12	M37x1.5	15	37	34.8	230±0.15

Size	Stroke [mm]	L2 ±0.1	L3	L4	L5 ±0.2	C1	C2
16	20	53	28.5+0.4/-0.3	8.5+0.45/-0.4	-	24	5
	40		48.5+0.4/-0.3				
20	25	60	35.6+0.4/-0.3	10.6+0.45/-0.4	-	30	5
	50		60.6+0.4/-0.3				
25	40	80	52.8+0.4/-0.3	12.8+0.45/-0.4	28	36	6
32	60	108	76+0.5/-0.4	16+0.5/-0.4	28	46	6

Ordering data

Size	Stroke [mm]	Part No.	Type
16	20	1155690	DYHR-16-20-Y5
	40	1155691	DYHR-16-40-Y5
20	25	1155692	DYHR-20-25-Y5
	50	1155693	DYHR-20-50-Y5
25	40	1155694	DYHR-25-40-Y5
32	60	1155696	DYHR-32-60-Y5

Accessories for cushioning components

Technical data

Mounting flange YSRF/YSRF-C

Material:
Steel

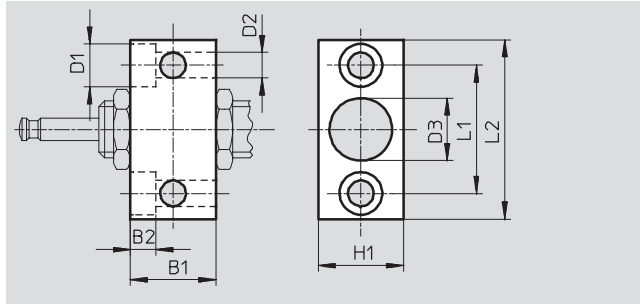
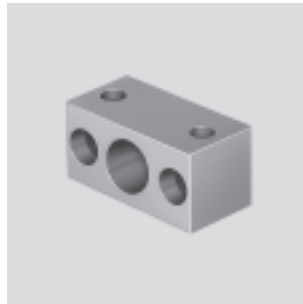

Possible combinations					
Cushioning components Mounting flange	DYSR-...-		YSR-C	YSRW	YDR
	Y5	Y5-T			
YSRF					
YSRF-8	-	-	■ ¹⁾	■ ¹⁾	-
YSRF-12	■	-	-	-	-
YSRF-16	■	-	-	-	■
YSRF-20	■	-	-	-	■
YSRF-25	■	-	■	-	■
YSRF-32	■	-	■	-	■
YSRF-C					
YSRF-8-C	■	-	■	■	-
YSRF-12-C	-	■	■	■	-
YSRF-16-C	-	■	■	■	-
YSRF-20-C	-	■	■	■	-

1) For shock absorber size $\varnothing 7$

Dimensions and ordering data												
YSRF												
For size [mm]	B1	B2	D1	D2	D3	H1	L1	L2	CRC ¹⁾	Weight [g]	Part No.	Type
8	16	5.5	10	5.5	10.2	16	25	38	2	50	11681	YSRF-8
12	25	6.8	11	6.6	15.2	25	36	50	2	175	11682	YSRF-12
16	30	9	15	9	20.2	30	45	63	2	300	11683	YSRF-16
20	36	11	18	11	24.2	36	56	78	2	535	11684	YSRF-20
25	45	13	20	13.5	30.2	45	63	86	2	895	11685	YSRF-25
32	55	15	24	15.5	37.2	55	80	108	2	1,730	11686	YSRF-32

1) Corrosion resistance class 2 according to Festo standard 940 070
Components requiring moderate corrosion resistance. Externally visible parts with primarily decorative surface requirements which are in direct contact with a surrounding industrial atmosphere or media such as cooling or lubricating agents

YSRF-C												
For size [mm]	B1	B2	D1	D2	D3	H1	L1	L2	CRC ¹⁾	Weight [g]	Part No.	Type
8	20	5.5	10	5.5	12.2	20	28	41	2	90	34575	YSRF-8-C
12	25	6.8	11	6.6	16.2	25	36	50	2	180	34576	YSRF-12-C
16	32	9	15	9	22.2	32	45	63	2	330	34577	YSRF-16-C
20	40	11	18	11	26.2	40	56	78	2	700	34578	YSRF-20-C

1) Corrosion resistance class 2 according to Festo standard 940 070
Components requiring moderate corrosion resistance. Externally visible parts with primarily decorative surface requirements which are in direct contact with a surrounding industrial atmosphere or media such as cooling or lubricating agents

Accessories for cushioning components

Technical data

Mounting flange YSRF-S-C

Material:
Aluminium, steel
Free of copper, PTFE and silicone

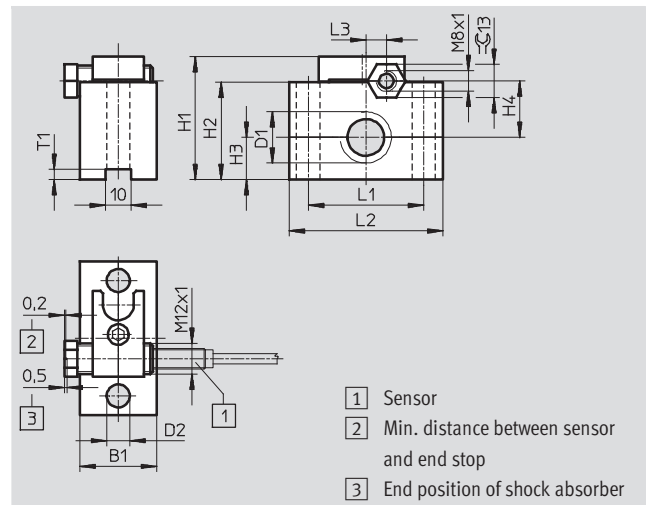

Possible combinations		
Cushioning components	YSR-C	YSRW
Mounting flange		
YSRF-S-8-C	■	■
YSRF-S-12-C	■	■
YSRF-S-16-C	■	■
YSRF-S-20-C	■	■

Dimensions and ordering data														
For size	B1	D1	D2 ∅	H1	H2	H3	H4	L1	L2	L3	T1	Weight [g]	Part No.	Type
[mm]														
8	20	M12x1	5.5	35	25	9.5	16	32	45	4	2	12	34579	YSRF-S-8-C
12	25	M16x1	6.6	42	32	12.5	20	36	50	3	4	130	34580	YSRF-S-12-C
16	30	M22x1.5	9	48	38	16.5	22	45	60	8	4	180	34581	YSRF-S-16-C
20	30	M26x1.5	11	52	42	19	23.5	56	80	11.5	4	250	34582	YSRF-S-20-C

Note
Inductive sensors for position sensing → 45

Accessories for cushioning components

Technical data

Buffer YSRP

Material:
Steel, polyurethane

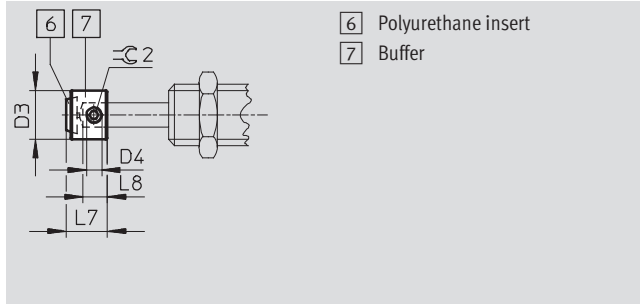

Dimensions and ordering data									
For size [mm]	D3	D4	L7	L8	$\text{R}2$	CRC ¹⁾	Weight [g]	Part No.	Type
8	8	M2	6,7	4	0,9	2	4	539638	YSRP-8
12	12	M4	10	6	2	2	7	11133	YSRP-12
16	16	M5	13.5	8	2.5	2	15	11134	YSRP-16
20	20	M6	17	10	3	2	27	11135	YSRP-20
25	25	M8	20.5	12	4	2	52	11136	YSRP-25
32	32	M8	26	15	4	2	110	11137	YSRP-32

1) Corrosion resistance class 2 according to Festo standard 940 070
Components requiring moderate corrosion resistance. Externally visible parts with primarily decorative surface requirements which are in direct contact with a surrounding industrial atmosphere or media such as cooling or lubricating agents

Stop limiter YSRA-C

Material:
Steel

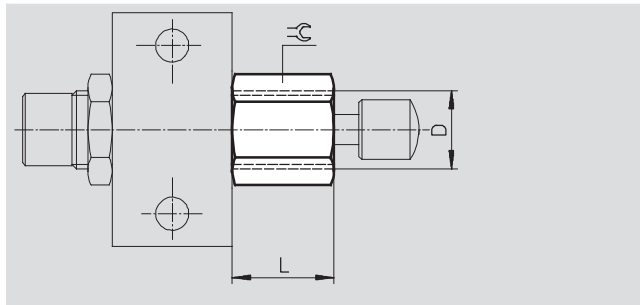

Dimensions and ordering data						
For size [mm]	D	L	R	Weight [g]	Part No.	Type
7	M10x1	14.5	13	12	150932	YSRA-7-C
8	M12x1	18	15	28	150933	YSRA-8-C
12	M16x1	24.5	19	48	150934	YSRA-12-C

Accessories for cushioning components

Technical data

Reducing sleeve DAYH

Material:
Stainless steel



To improve the cushioning performance in the case of underload, the built-in shock absorber can be replaced by the next smallest shock absorber with the help of the reducing sleeve.





Built-in shock absorber	Part No.	Reducing sleeve	Part No.	Next smallest shock absorber
YSR...-C				
YSR-5-5-C	1165476	DAYH-4	540060	YSR-4-4-C
DYSC...				
DYSC-8-8-Y1F	1165484	DAYH-7	548012	DYSC-7-5-Y1F
DYSC-7-5-Y1F	1165480	DAYH-5	548011	DYSC-5-5-Y1F
DYSW...				
DYSW-12-20-Y1F	1165491	DAYH-10	548074	DYSW-10-17-Y1F
DYSW-10-17-Y1F	1165488	DAYH-8	548073	DYSW-8-14-Y1F
DYSW-8-14-Y1F	1165484	DAYH-7	548072	DYSW-7-10-Y1F
DYSW-7-10-Y1F	1165480	DAYH-5	548071	DYSW-5-8-Y1F
DYSW-5-8-Y1F	1165476	DAYH-4	548070	DYSW-4-6-Y1F



Ordering data – Proximity sensors for T-slot, magneto-resistive					Technical data → Internet: smt	
	Type of mounting	Switch output	Electrical connection	Cable length [m]	Part No.	Type
N/O contact						
	Insertable in the slot from above, flush with cylinder profile	PNP	Cable, 3-wire	2.5	543867	SMT-8M-PS-24V-K-2,5-OE
			Plug M8x1, 3-pin	0.3	543866	SMT-8M-PS-24V-K-0,3-M8D
	Insertable in the slot lengthwise, flush with the cylinder profile	PNP	Cable, 3-wire	2.5	543870	SMT-8M-NS-24V-K-2,5-OE
			Plug M8x1, 3-pin	0.3	543871	SMT-8M-NS-24V-K-0,3-M8D
N/C contact						
	Insertable in the slot from above, flush with cylinder profile	PNP	Cable, 3-wire	7.5	543873	SMT-8M-PO-24V-K7,5-OE

Ordering data – Proximity sensors for T-slot, magnetic reed					Technical data → Internet: sme	
	Type of mounting	Switch output	Electrical connection	Cable length [m]	Part No.	Type
N/O contact						
	Insertable in the slot from above, flush with cylinder profile	Contacting	Cable, 3-wire	2.5	543862	SME-8M-DS-24V-K-2,5-OE
			Plug M8x1, 3-pin	0.3	543861	SME-8M-DS-24V-K-0,3-M8D
	Insertable in the slot lengthwise, flush with the cylinder profile	Contacting	Cable, 3-wire	2.5	150855	SME-8-K-LED-24
			Plug M8x1, 3-pin	0.3	150857	SME-8-S-LED-24
N/C contact						
	Insertable in the slot lengthwise, flush with the cylinder profile	Contacting	Cable, 3-wire	7.5	160251	SME-8-O-K-LED-24

Accessories for cushioning components

Technical data

Ordering data – Inductive sensors M8, for mounting flange YSRF-S-C						Technical data → Internet: sien	
	Electrical connection		Switch output	LED	Cable length [m]	Part No.	Type
	Cable	M8 plug					
NO contact							
	3 wires	–	PNP	■	2.5	150386	SIEN-M8B-PS-K-L
	–	3-pin	PNP	■	–	150387	SIEN-M8B-PS-S-L
NC contact							
	3 wires	–	PNP	■	2.5	150390	SIEN-M8B-PO-K-L
	–	3-pin	PNP	■	–	150391	SIEN-M8B-PO-S-L

Ordering data – Connecting cables				Technical data → Internet: nebu	
	Electrical connection, left	Electrical connection, right	Cable length [m]	Part No.	Type
	Straight socket, M8x1, 3-pin	Cable, open end, 3-wire	2.5	541333	NEBU-M8G3-K-2.5-LE3
			5	541334	NEBU-M8G3-K-5-LE3
	Angled socket, M8x1, 3-pin	Cable, open end, 3-wire	2.5	541338	NEBU-M8W3-K-2.5-LE3
			5	541341	NEBU-M8W3-K-5-LE3

Calculation tool for cushioning components

Technical data

This selection aid helps you find the right shock absorber for every application.

When you are choosing a shock absorber, we recommend that you proceed as follows:

1. Determine the following values, effective at the time of impact:
 - Force (A)
 - Equivalent mass m_{equiv}
 - Impact velocity (v)
2. Select a shock absorber from the graphs on the following pages.
3. Check your selection on the basis of its maximum cushioning energy ($W_{max.}$)

 Note

Sizing software
Shock absorber selection
→ www.festo.com

When you are choosing a shock absorber for your application, ensure that the following values are not exceeded:

- Permissible energy load per stroke:
 - $W_{min.} = 25\%$
 - $W_{max.} = 100\%$
- Recommended energy load per stroke:
 - $W_{opt.} = 50\% \dots 100\%$
- Max. energy absorption per hour
- Max. residual energy
- Max. stop force in end position

The (angular) velocity required in the formulae is the velocity at the time of the impact on the shock absorber. This depends on the dynamic characteristics of the drive component and is thus difficult to determine.

It is better to determine the mean velocity ($v_m = s/t$ or $\omega_m = \varphi/t$).

In order to prevent damage to the drive concerned, calculations should in the interests of safety be based on the following values:

- $v = 1.25 \dots 2 v_m$
 - $\omega = 1.25 \dots 2 \omega_m$
- Guide values for linear motions:
Factor 2 with strokes < 50 mm,
factor 1.5 with strokes > 50 mm and < 100 mm,
factor 1.25 with strokes > 100 mm.

The fact that the (angular) velocity appears in the calculation as a squared value means that the expected error becomes considerably larger. The calculation can thus be regarded only as an approximation. The safety factor does, however, ensure that the selected shock absorber is not too small.

The following formulae are required for the calculation:

$$A = F + G$$

$$A = F + m \times g \times \sin \alpha$$

$$W_{total} = \frac{1}{2} \times m \times v^2 + A \times s < W_{max.}$$

$$W_h = W_{total} \times \text{Stroke} \div \text{Hours} < W_{hmax.}$$

The following applies additionally for rotary motions:

$$m_{equiv.} = \frac{J}{R^2}$$

$$v = \omega \times R$$

$$A = \frac{M}{R} + m \times g \times \sin \alpha \times \frac{a}{R}$$

The following abbreviations are used:

- | | | |
|---|--|--|
| A = Additional force = F + G [N] | v = Impact velocity [m/s] | J = Mass moment of inertia [kg x m ²] |
| F = Cylinder force minus frictional force [N] | $m_{equiv.}$ = Equivalent mass [kg] | R = Distance between mass pivot point and shock absorber [m] |
| G = Force due to weight = m x g x sin α | g = Acceleration due to gravity 9.81 [m/s ²] | ω = Angular velocity [rad/s] |
| | s = Shock absorber stroke [m] | M = Drive torque [Nm] |
| | α = Impact angle [°] | a = Distance between centre of gravity of mass and pivot point |
| Special cases: | W_{total} = Cushioning work/stroke [J] | |
| α = 0°: Horizontal motion | W_h = Cushioning work/hour [J] | |
| G = 0 | | |
| α = 90°: Downward motion | | |
| G = m x g | | |
| α = 90°: Upward motion: | | |
| G = -m x g | | |

Calculation tool for cushioning components

Technical data

Sizing example for linear motion

This example illustrates the procedure for the selection of a shock absorber for the application shown in the adjacent drawing:

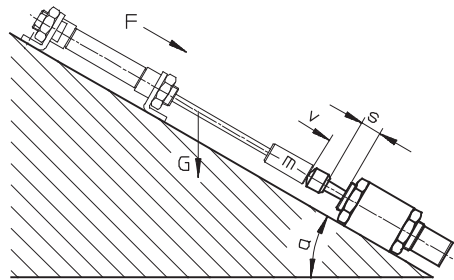

$m = 50 \text{ kg}$
 $v = 1.5 \text{ m/s}$
 $\alpha = 45^\circ$
 $F = 190 \text{ N}$

$$A = F + m \times g \times \sin \alpha$$

$$= 190 \text{ N} + 50 \times 9.81 \times \sin 45^\circ$$

$$= 537 \text{ N}$$

$$m_{\text{equiv}} = m = 50 \text{ kg}$$

($\varnothing 20 \text{ mm}$ with $p = 6 \text{ bar}$,
 1,800 strokes per hour)

In the process of selecting shock absorbers on the basis of the graphs (see data sheets), the force (A) is governed by the first curve to the right of the point of intersection of the equivalent mass (m_{equiv}) and the impact velocity (v). The curves move to the left as the additional force increases.

Three force curves are given for each shock absorber. Interim values must be calculated by averaging. As the

graphs show (continuous line), possible choices are the shock absorbers DYSR-25-40 and YSR-25-40-C. We must now determine whether the maximum permissible values for cushioning work (W_{max}) and cushioning work per hour (W_{hmax}) are not being exceeded. These maximum permissible values and the stroke length (s) can be found in the tables (below the graphs).

Experiment:

$$W_{\text{total}} = \frac{1}{2} \times m \times v^2 + A \times s$$

$$= (1/2 \times 50 \times 1.5^2 + 537 \times 0.04) \text{ Nm} = 78 \text{ J}$$

$$W_{\text{h}} = W_{\text{total}} \times \text{strokes/h}$$

$$= 78 \text{ Nm} \times 1,800$$

$$= 140,000 \text{ J}$$

For the above application, both shock absorbers are suitable.

Further selection criteria are adjustment facilities and size.

Result	DYSR-25-40	YSR-25-40-C
W_{total}	78 J	78 J
W_{h}	140,000 J	140,000 J
$W_{\text{max.}}^{1)}$	160 J > W_{total}	160 J > W_{total}
$W_{\text{hmax.}}$	220,000 > W_{h}	150,000 > W_{h}

1) The degree of utilisation is 49% in both cases.

Calculation tool for cushioning components

Technical data

Sizing example for rotary motion

Example for rotary motion:

$$m_{\text{equiv}} = J/R^2 = 8 \text{ kg}$$

$$v = \omega \times R$$

$$A = M/R = 40 \text{ N}$$

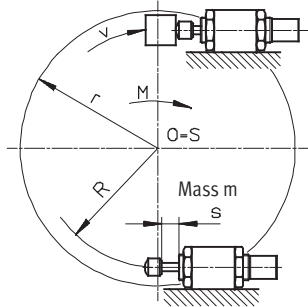

$$J = 2 \text{ kg m}^2$$

$$\omega = 4 \text{ rad/s}$$

$$R = 0.5 \text{ m}$$

$$M = 20 \text{ Nm}$$

900 strokes per hour

In the process of selecting shock absorbers on the basis of graphs (see data sheets), the force (A) is governed by the first curve to the right of the point of intersection of the equivalent mass (m_{equiv}) and the impact velocity (v). The curves move to the left as the additional force increases.

Three force curves are given for each shock absorber. Interim values must be calculated by averaging. As the graphs show (dotted line), possible choices are the shock absorbers DYSR-16-20 and YSR-16-20-C.

We must now determine whether the maximum permissible values for cushioning work (W_{max}) and cushioning work per hour (W_{hmax}) are not being exceeded. These maximum permissible values and the stroke length (s) can be found in the tables (below the graphs).

Note: The impact angle must be noted with rotary applications.

$$\tan \alpha = \frac{s}{R}$$

s = Cushioning stroke

Experiment:

$$\begin{aligned} W_{\text{total}} &= \frac{1}{2} \times m \times v^2 + A \times s \\ &= (1/2 \times 8 \times 2^2 + \\ &40 \times 0.02) \text{ J} = 17 \text{ J} \end{aligned}$$

$$\begin{aligned} W_{\text{h}} &= W_{\text{total}} \times \text{strokes/h} \\ &= 17 \text{ J} \times 900 \\ &= 15,300 \text{ J} \end{aligned}$$

For the above application, both shock absorbers are suitable.

Further selection criteria are adjustment facilities and size.

Result	DYSR-16-20 ³⁾	YSR-16-20-C
W_{total}	17 J	17 J
W_{h}	15,300 J	15,300 J
W_{max}	32 J > W_{total} ¹⁾	30 J > W_{total} ²⁾
W_{hmax}	100,000 > W_{h}	64,000 > W_{h}

1) The degree of utilisation is 53%.

2) The degree of utilisation is 57%.

3) Use without buffer.