





One-way flow control valves, NPT



# One-way flow control valves, NPT

Product range overview

Version	Valve function	Type	Pneumatic connection								→ Page/ Internet
			Thread	Tubing Ø							
				1/8	5/32	3/16	1/4	5/16	3/8	1/2	
<b>Standard</b>											
	One-way flow control function for exhaust air	GRLA-...-QB 	UNF 10/32	■	■	■	■	-	-	-	4
			1/8	-	■	■	■	■	-	-	
			1/4	-	■	■	■	■	■	-	
			3/8	-	-	■	■	■	■	■	
			1/2	-	-	-	-	■	■	■	
		GRLA-...-QS	1/16	-	-	■	■	-	-	-	10
1/4	-	-	■	-	-	-	-				
<b>In-line installation</b>											
	One-way flow control function	GR-QB 	5/32	-	■	-	-	-	-	-	11
			3/16	-	-	■	-	-	-	-	
			1/4	-	-	-	■	-	-	-	
			5/16	-	-	-	-	■	-	-	
			3/8	-	-	-	-	-	■	-	
			1/2	-	-	-	-	-	-	■	

# One-way flow control valves, NPT

Type codes



		GRLA	-	1/16	-	QS	-	3/8	-	U
<b>Type</b>										
Screw-in thread										
GRLA	One-way flow control valve for exhaust air									
Front panel and in-line mounting										
GR	One-way flow control valve									
<b>Screw-in and connecting thread</b>										
UNF10/32	UNF thread									
1/8	NPT thread									
3/16	NPT thread									
1/16	NPT thread									
1/4	NPT thread									
3/8	NPT thread									
1/2	NPT thread									
<b>Tube coupling Ø</b>										
Type of connection										
QB	Push-in connector for standard O.D. tubing									
QS	Push-in connector for standard O.D. tubing									
For tubing O.D.										
1/8, 3/32, 3/16, 1/4, 5/16, 3/8, 1/2										
<b>Series</b>										
U	U series									

# One-way flow control valves GRLA, NPT

Technical data – Push-in connector QB

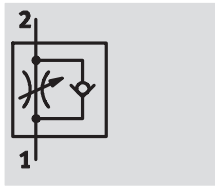
**Function**



-  - Temperature range  
32 ... 140 °F
-  - Operating pressure  
-13.8 ... +116 psi



- Push-in connector QB
- Swivel connection can be swivelled around installation axis after mounting

General technical data						
Type GRLA	10-32-UNF	1/8	1/4	3/8	1/2	
Pneumatic connection 1	QB-1/8	–	–	–	–	
	QB-5/32	QB-5/32	QB-5/32	–	–	
	QB-3/16	QB-3/16	QB-3/16	QB-3/16	–	
	QB-1/4	QB-1/4	QB-1/4	QB-1/4	–	
	–	QB-5/16	QB-5/16	QB-5/16	QB-5/16	QB-5/16
	–	–	QB-3/8	QB-3/8	QB-3/8	QB-3/8
	–	–	–	QB-1/2	QB-1/2	
Pneumatic connection 2	UNF10-32	NPT1/8-27	NPT1/4-18	NPT3/8-18	NPT1/2-14	
Valve function	One-way flow control function for exhaust air					
Actuation type	Manual					
Adjustment component	Slotted head screw					
Mounting position	Any					
Type of mounting	Screw-in					
	Via male thread					
Max. tightening torque [ft-lbf]	1.1	5.2	8.9	16.2	20.7	

Operating and environmental conditions	
Operating medium	Filtered air, lubricated or unlubricated, grade of filtration 40 µm
Operating pressure [psi]	-13.8 ... +116
Ambient temperature [°F]	32 ... 140
Temperature of medium [°F]	32 ... 140

Materials	
Threaded plug	Nickel-plated brass
Seals	NBR
Hollow bolt	Nickel-plated brass
Release ring	POM
Knurled head	Nickel-plated brass
Regulating screw	Nickel-plated brass
Swivel connection	PBT-reinforced
Note on materials	Contains PWIS (paint wetting impairment substances)
	RoHS-compliant

# One-way flow control valves GRLA, NPT

Technical data – Push-in connector QB

**FESTO**

Standard nominal flow rate q <sub>nN</sub> [cfm] at 6 bar → 5 bar						
Type GRLA		10-32-UNF	1/8	1/4	3/8	1/2
QB-1/8	F <sup>1)</sup>	1.87	–	–	–	–
	N <sup>2)</sup>	1.45 ... 1.91	–	–	–	–
QB-5/32	F <sup>1)</sup>	1.7	7.56	12	–	–
	N <sup>2)</sup>	1.31 ... 1.73	5.83 ... 7.7	9.25 ... 12.25	–	–
QB-3/16	F <sup>1)</sup>	1.87	6.78	9.5	10.6	–
	N <sup>2)</sup>	1.41 ... 1.911	5.23 ... 6.92	7.31 ... 9.68	8.1 ... 10.8	–
QB-1/4	F <sup>1)</sup>	2.26	8.44	16.6	19.7	–
	N <sup>2)</sup>	1.73 ... 2.3	6.5 ... 8.62	12.78 ... 16.91	15.2 ... 20.1	–
QB-5/16	F <sup>1)</sup>	–	8.37	18.7	28.1	42.4
	N <sup>2)</sup>	–	6.43 ... 8.55	14.37 ... 19.1	21.65 ... 28.7	32.6 ... 43.2
QB-3/8	F <sup>1)</sup>	–	–	17.13	29	41.8
	N <sup>2)</sup>	–	–	13.2 ... 17.5	22.3 ... 29.5	32.2 ... 42.7
QB-1/2	F <sup>1)</sup>	–	–	–	30.7	48.1
	N <sup>2)</sup>	–	–	–	23.6 ... 31.3	37.1 ... 49.1

1) F Flow control direction

2) N Non-return direction

Standard flow rate q <sub>n</sub> [cfm] at 6 bar → 0 bar						
Type GRLA		10-32-UNF	1/8	1/4	3/8	1/2
QB-1/8	F <sup>1)</sup>	3.3	–	–	–	–
	N <sup>2)</sup>	3.23 ... 3.4	–	–	–	–
QB-5/32	F <sup>1)</sup>	3	11.5	15.7	–	–
	N <sup>2)</sup>	3 ... 3.14	11.4 ... 11.9	15.7 ... 16.4	–	–
QB-3/16	F <sup>1)</sup>	3.3	10.9	13.6	13.7	–
	N <sup>2)</sup>	3.32 ... 3.43	10.9 ... 11.3	13.6 ... 14.2	13.7 ... 14.3	–
QB-1/4	F <sup>1)</sup>	3.9	13.8	25	28.1	–
	N <sup>2)</sup>	3.92 ... 4.1	13.8 ... 14.3	25 ... 26	28.1 ... 29.2	–
QB-5/16	F <sup>1)</sup>	–	13.5	31.4	43.5	59.3
	N <sup>2)</sup>	–	13.5 ... 14	31.4 ... 32.6	43.5 ... 45.2	59.6 ... 61.6
QB-3/8	F <sup>1)</sup>	–	–	28.5	45.8	59.7
	N <sup>2)</sup>	–	–	28.5 ... 29.6	45.8 ... 47.6	59.7 ... 62.1
QB-1/2	F <sup>1)</sup>	–	–	–	50.5	76.1
	N <sup>2)</sup>	–	–	–	50.5 ... 52.5	76.1 ... 79.1

1) F Flow control direction

2) N Non-return direction

# One-way flow control valves GRLA, NPT

Technical data – Push-in connector QB

**Standard nominal flow rate  $q_{nN}$  [l/min] at 6 bar  $\rightarrow$  5 bar as a function of turns of the flow control screw n**

Pneumatic connection UNF10-32

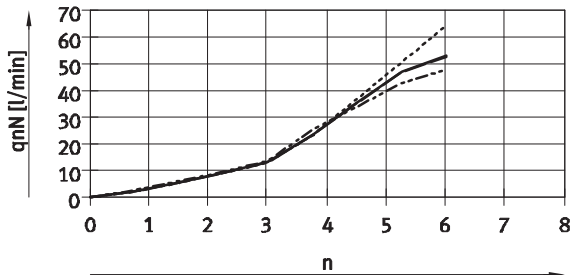

- QB-1/8
- - - QB-5/32
- · - QB-3/16
- · · QB-1/4

**Standard flow rate  $q_n$  in non-return direction at 6 bar  $\rightarrow$  0 bar as a function of turns of the flow control screw n**

Pneumatic connection UNF10-32

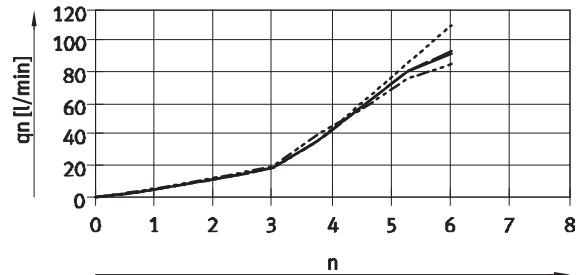

- QB-1/8
- - - QB-5/32
- · - QB-3/16
- · · QB-1/4

Pneumatic connection NPT $\frac{1}{8}$ -27

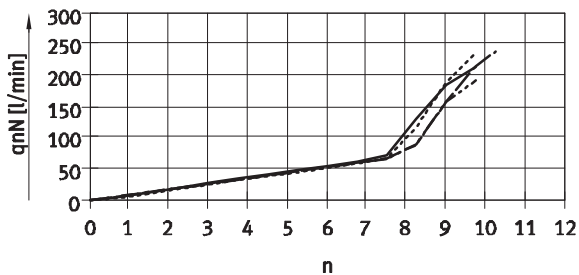

- QB-5/32
- - - QB-3/16
- · - QB-1/4
- · · QB-5/16

Pneumatic connection NPT $\frac{1}{8}$ -27

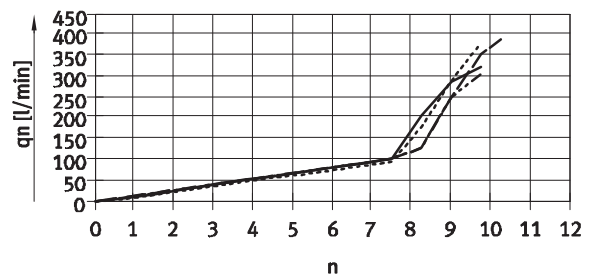

- QB-5/32
- - - QB-3/16
- · - QB-1/4
- · · QB-5/16

Pneumatic connection NPT $\frac{1}{4}$ -18

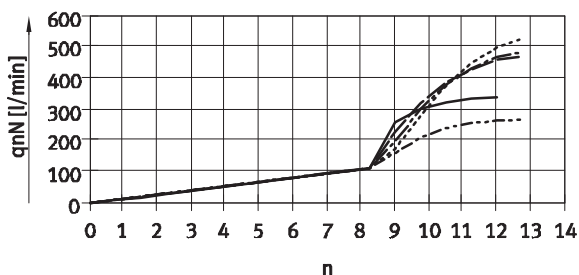

- QB-5/32
- - - QB-3/16
- · - QB-1/4
- · · QB-5/16
- · · QB-3/8

Pneumatic connection NPT $\frac{1}{4}$ -18

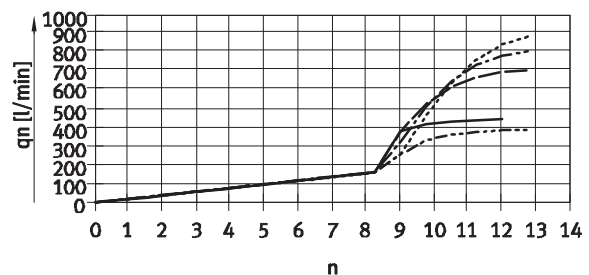

- QB-5/32
- - - QB-3/16
- · - QB-1/4
- · · QB-5/16
- · · QB-3/8

# One-way flow control valves GRLA, NPT

Technical data – Push-in connector QB

Standard nominal flow rate  $q_{nN}$  [l/min] at 6 bar  $\rightarrow$  5 bar  
as a function of turns of the flow control screw  $n$

Pneumatic connection NPT $\frac{3}{8}$ -18

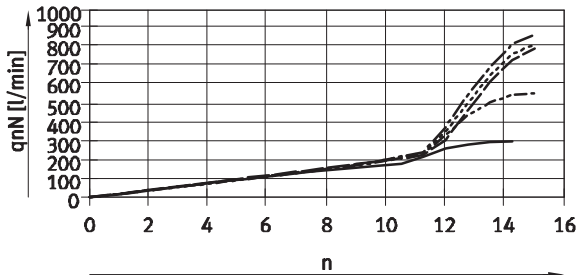

- QB-3/16
- - - QB-1/4
- · - QB-5/16
- · · QB-3/8
- · - QB-1/2

Standard flow rate  $q_n$  at 6 bar  $\rightarrow$  0 bar  
as a function of turns of the flow control screw  $n$

Pneumatic connection NPT $\frac{3}{8}$ -18

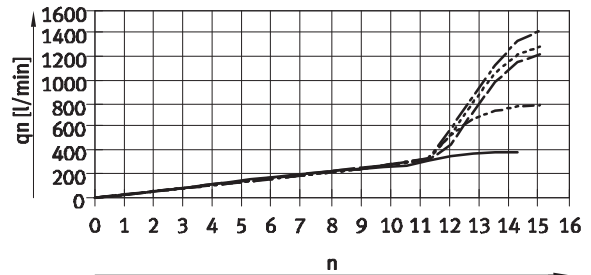

- QB-3/16
- - - QB-1/4
- · - QB-5/16
- · · QB-3/8
- · - QB-1/2

Pneumatic connection NPT $\frac{1}{2}$ -14

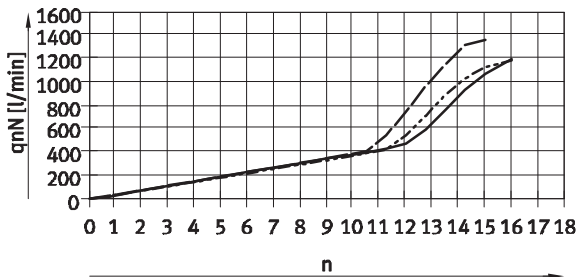

- QB-5/16
- - - QB-3/8
- · - QB-1/2

Pneumatic connection NPT $\frac{1}{2}$ -14

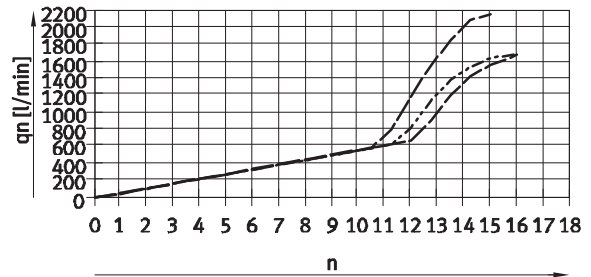

- QB-5/16
- - - QB-3/8
- · - QB-1/2

# One-way flow control valves GRLA, NPT

Technical data – Push-in connector QB

**Dimensions**

Download CAD data → [www.festo.com](http://www.festo.com)

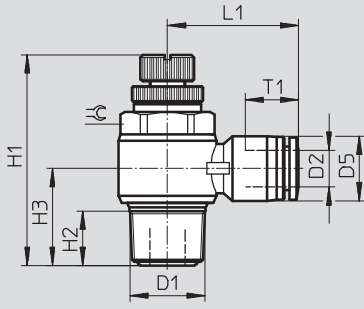

Type	Connection D1	Tubing O.D. D2	D5	H1		H2	H3	L1	T1	⌀	Weight [oz]
				min.	max.						
GRLA-10-32-UNF	UNF10/32	1/8	7.8	26.9	29.1	3.6	10.3	16.5	11.4	5/16	0.3
		5/32	10.5								0.35
		3/16	11.5								0.34
		1/4	13.0								0.38
GRLA-1/8	NPT1/8	5/32	10.5	34.9	39.8	8.2	15.1	23.7	14.9	7/16	0.66
		3/16	11.5								0.66
		1/4	13.0								0.7
		5/16	14.5								0.77
GRLA-1/4	NPT1/4	5/32	10.5	40.6	47.0	11.0	18.4	25.6	14.9	19/32	1.2
		3/16	11.5								1.2
		1/4	13.0								1.26
		5/16	14.5								1.33
		3/8	17.5								1.38
GRLA-3/8	NPT3/8	1/4	13.0	47.9	54.9	13.1	21.9	28.4	16.8	3/4	2.35
		3/16	11.5								2.31
		5/16	14.5								2.46
		3/8	17.5								2.48
		1/2	20.8								2.61
GRLA-1/2	NPT1/2	5/16	14.5	53.9	61.3	16.5	26.5	32.4	18.7	15/16	3.66
		3/8	17.5								3.85
		1/2	20.8								4.2



# One-way flow control valves GRLA, NPT

Technical data – Push-in connector QB

FESTO

Ordering data				
Design	Pneumatic connection 2	Pneumatic connection 1	Part No.	Type
	UNF10-32	1/8	564839	GRLA-10-32-UNF-QB-1/8-U
		5/32	564840	GRLA-10-32-UNF-QB-5/32-U
		3/16	564841	GRLA-10-32-UNF-QB-3/16-U
		1/4	564842	GRLA-10-32-UNF-QB-1/4-U
	NPT1/8-27	5/32	534656	GRLA-1/8-QB-5/32-U
		3/16	534657	GRLA-1/8-QB-3/16-U
		1/4	534658	GRLA-1/8-QB-1/4-U
		5/16	534659	GRLA-1/8-QB-5/16-U
	NPT1/4-18	5/32	564843	GRLA-1/4-QB-5/32-U
		3/16	534660	GRLA-1/4-QB-3/16-U
		1/4	534661	GRLA-1/4-QB-1/4-U
		5/16	534662	GRLA-1/4-QB-5/16-U
		3/8	534663	GRLA-1/4-QB-3/8-U
	NPT3/8-18	1/4	534664	GRLA-3/8-QB-1/4-U
		3/16	564844	GRLA-3/8-QB-3/16-U
		5/16	534665	GRLA-3/8-QB-5/16-U
		3/8	534666	GRLA-3/8-QB-3/8-U
		1/2	534667	GRLA-3/8-QB-1/2-U
	NPT1/2-14	5/16	564845	GRLA-1/2-QB-5/16-U
		3/8	564846	GRLA-1/2-QB-3/8-U
1/2		564847	GRLA-1/2-QB-1/2-U	



# One-way flow control valves GRLA, NPT

Technical data – Push-in connector QS

FESTO

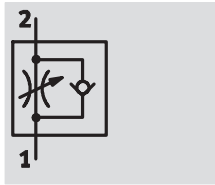
Function



-  - Temperature range  
0 ... +60 °C
-  - Operating pressure  
1 ... 9 bar



- Push-in connector QS
- Connection can be rotated around installation axis after mounting

General technical data		
Type GRLA	1/16-NPT	1/4-NPT
Pneumatic connection 1	QS-3/16	QS-3/16
	QS-1/4	-
Pneumatic connection 2	NPT1/16-27	NPT1/4-18
Valve function	One-way flow control function	
Actuation type	Manual	
Adjustment component	Knurled screw	
Mounting position	Any	

Operating and environmental conditions	
Operating medium	Filtered air, lubricated or unlubricated, grade of filtration 40 µm
Operating pressure [bar]	1 ... 9
Ambient temperature [°C]	0 ... +60
Temperature of medium [°C]	0 ... +60

Weight		
Type GRLA	1/16-NPT	1/4-NPT
Weight [g]	18	36

Materials	
Housing	PBT-reinforced
Threaded plug	Brass
Release ring	POM

Standard nominal flow rate qnN [l/min] at 6 bar → 5 bar			
Type GRLA		1/16-NPT	1/4-NPT
QS-3/16	F <sup>1)</sup>	56	170
	N <sup>2)</sup>	34	130
QS-1/4	F <sup>1)</sup>	56	-
	N <sup>2)</sup>	35	-

- 1) F Flow control direction  
2) N Non-return direction



Ordering data				
Design	Pneumatic connection 2	Pneumatic connection 1	Part No.	Type
	NPT1/16-27	3/16	192858	GRLA-1/16-NPT-QS-3/16-U
		1/4	192859	GRLA-1/16-NPT-QS-1/4-U
	NPT1/4-18	3/16	190944	GRLA-1/4-NPT-QS-3/16-U

# One-way flow control valves GR, NPT

Technical data

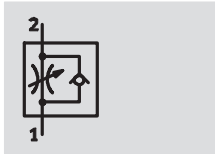
## Function



-  Temperature range  
32 ... 140 °F
-  Operating pressure  
-13.8 ... +116 psi



- One-way flow control valve for in-line installation
- Adjustment via knurled screw
- Push-in connector QB for standard O.D. tubing QB- $\frac{5}{32}$ ,  $\frac{3}{16}$ ,  $\frac{1}{4}$ ,  $\frac{5}{16}$ ,  $\frac{3}{8}$ ,  $\frac{1}{2}$

General technical data						
Type GR	QB- $\frac{5}{32}$	QB- $\frac{3}{16}$	QB- $\frac{1}{4}$	QB- $\frac{5}{16}$	QB- $\frac{3}{8}$	QB- $\frac{1}{2}$
Valve function	One-way flow control function					
Actuation type	Manual					
Adjustment component	Slotted head screw					
Mounting position	Any					
Type of mounting	In-line installation					
	Via through-hole					
Pneumatic connection 1 and 2	QB- $\frac{5}{32}$	QB- $\frac{3}{16}$	QB- $\frac{1}{4}$	QB- $\frac{5}{16}$	QB- $\frac{3}{8}$	QB- $\frac{1}{2}$

Operating and environmental conditions	
Operating medium	Filtered compressed air, lubricated or unlubricated, grade of filtration 40 µm
Operating pressure [psi]	-13.8 ... +116
Ambient temperature [°F]	32 ... 140
Temperature of medium [°F]	32 ... 140

Weight						
Type GR	QB- $\frac{5}{32}$	QB- $\frac{3}{16}$	QB- $\frac{1}{4}$	QB- $\frac{5}{16}$	QB- $\frac{3}{8}$	QB- $\frac{1}{2}$
Weight [oz]	0.4	1	1	1.5	2.7	4.2

Materials	
Housing	PBT-reinforced
Threaded plug	Nickel-plated brass
Seals	NBR
Release ring	POM
Knurled head	Nickel-plated brass
Regulating screw	Nickel-plated brass
Note on materials	Contains PWIS (paint wetting impairment substances)
	RoHS-compliant

# One-way flow control valves GR, NPT

Technical data

Standard nominal flow rate  $q_{nN}$  [cfm] at 6 bar  $\rightarrow$  5 bar

Type GR	QB- $\frac{3}{32}$	QB- $\frac{3}{16}$	QB- $\frac{1}{4}$	QB- $\frac{5}{16}$	QB- $\frac{3}{8}$	QB- $\frac{1}{2}$
F <sup>1)</sup>	1.7	3.1	4.7	8	11.4	14
N <sup>2)</sup>	0.6 ... 1.7	2.6 ... 3.1	5 ... 5.5	5.7 ... 8.1	8.1 ... 11.7	10.8 ... 12.7

- 1) F: Flow control direction
- 2) N: Non-return direction

Standard flow rate  $q_n$  [cfm] at 6 bar  $\rightarrow$  0 bar

Type GR	QB- $\frac{3}{32}$	QB- $\frac{3}{16}$	QB- $\frac{1}{4}$	QB- $\frac{5}{16}$	QB- $\frac{3}{8}$	QB- $\frac{1}{2}$
F <sup>1)</sup>	3	5.3	7.8	13.5	19	23.2
N <sup>2)</sup>	2.4 ... 3.2	4.8 ... 5.1	10.6 ... 10.7	13.8 ... 13.9	20.5 ... 21.8	16.6 ... 20.2

- 1) F Flow control direction
- 2) N Non-return direction

Standard nominal flow rate  $q_{nN}$  at 6 bar  $\rightarrow$  5 bar as a function of turns of the flow control screw n

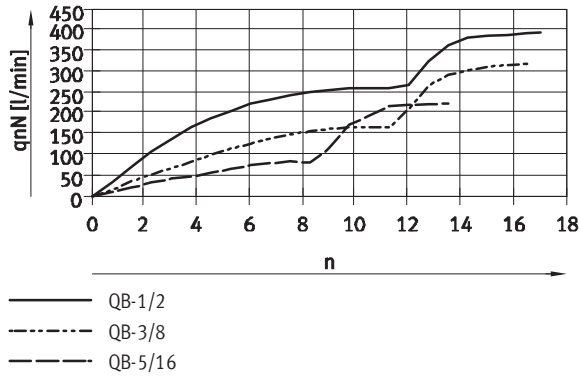

Standard flow rate  $q_n$  at 6 bar  $\rightarrow$  0 bar as a function of turns of the flow control screw n

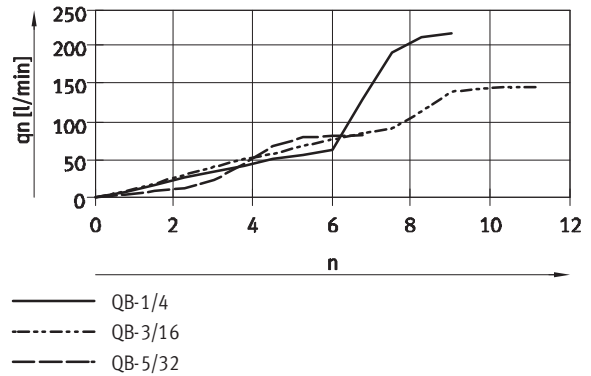
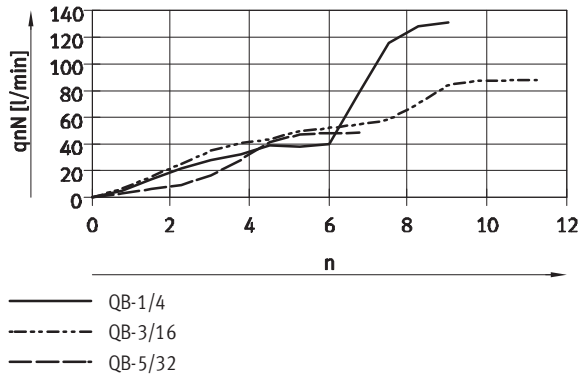
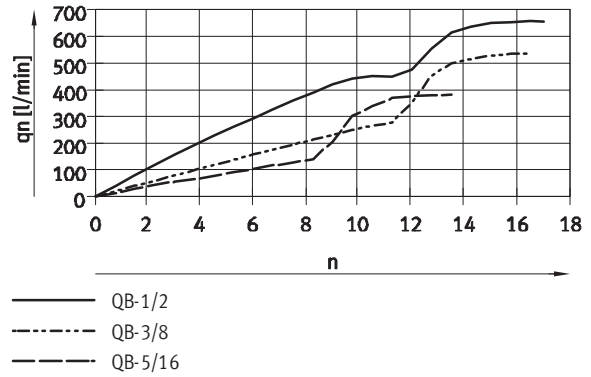

# One-way flow control valves GR, NPT

Technical data

**Dimensions**

Download CAD data → [www.festo.com](http://www.festo.com)

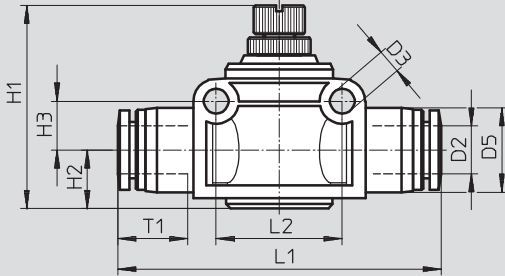

Type	Tubing O.D. D2	D3	D5	H1		H2	H3	L1	L2	T1
				min.	max.					
GR-QB-5/32-U	5/32	3.2	10.5	26.4	28.9	7.6	5.6	44.8	15.4	14.9
GR-QB-3/16-U	3/16	4.3	11.6	33.1	38.5	7.6	8.0	49.9	20.4	15.9
GR-QB-1/4-U	1/4	4.3	13.1	33.5	38.9	9.4	8.0	50.1	20.4	16.8
GR-QB-5/16-U	5/16	4.4	14.8	35.5	41.5	10.2	8.5	56.4	22.0	18.7
GR-QB-3/8-U	3/8	4.3	17.5	40.7	48.6	11.4	10.3	61.4	28.1	20.1
GR-QB-1/2-U	1/2	4.4	20.5	45.5	53.4	14.0	12.1	70.7	32.0	22.9

**Ordering data**

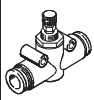
Design	Pneumatic connection 1	Pneumatic connection 2	Part No.	Type
	5/32	5/32	534680	GR-QB-5/32-U
	3/16	3/16	534681	GR-QB-3/16-U
	1/4	1/4	534682	GR-QB-1/4-U
	5/16	5/16	534683	GR-QB-5/16-U
	3/8	3/8	534684	GR-QB-3/8-U
	1/2	1/2	534685	GR-QB-1/2-U