

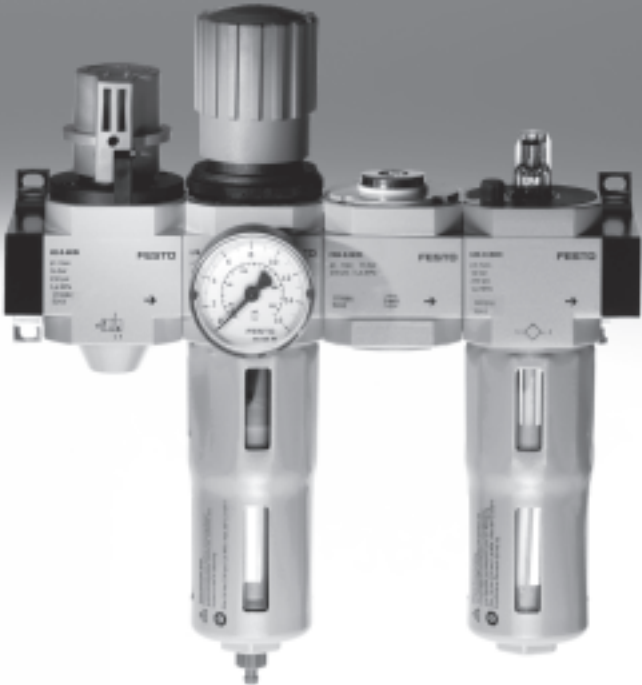

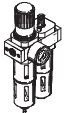

Service unit combinations FRC-K, D series

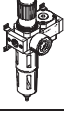
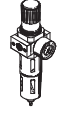
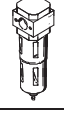
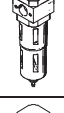
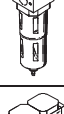

Service unit combinations FRC-K, D series, metal design

Product range overview D series service units, metal design

Type	Size	Pneumatic connection										Pressure regulation range [bar]			Grade of filtration [µm]			
		M5	M7	G1/8	G1/4	G3/8	G1/2	G3/4	G1	QS4	QS6	0.5 ...	0.5 ...	2.5 ...	0.01	1	5	40
Service units																		
FRC/FRCS 	Micro	■	■	■	-	-	-	-	-	■	■	■	-	-	-	-	■	-
	Mini	-	-	■	■	■	-	-	-	-	-	■	■	-	-	-	■	■
	Midi	-	-	-	■	■	■	■	-	-	-	■	■	-	-	-	■	■
	Maxi	-	-	-	-	-	■	■	■	-	-	■	■	-	-	-	■	■
Service unit combinations																		
FRC-K 	Micro	-	-	-	-	-	-	-	-	-	-	-	-	-	-	-	-	
	Mini	-	-	■	■	-	-	-	-	-	-	■	■	-	-	-	-	■
	Midi	-	-	-	■	■	■	-	-	-	-	■	■	-	-	-	-	■
	Maxi	-	-	-	-	-	■	■	-	-	-	■	■	-	-	-	-	■
LFR-K LFRS-K 	Micro	-	-	-	-	-	-	-	-	-	-	-	-	-	-	-	-	
	Mini	-	-	■	■	-	-	-	-	-	-	■	■	-	-	-	-	■
	Midi	-	-	-	■	■	■	-	-	-	-	■	■	-	-	-	-	■
	Maxi	-	-	-	-	-	■	■	-	-	-	■	■	-	-	-	-	■
Individual devices																		
Filter regulators LFR/LFRS 	Micro	■	■	■	-	-	-	-	-	■	■	■	-	-	-	-	■	-
	Mini	-	-	■	■	■	-	-	-	-	-	■	■	-	-	-	■	■
	Midi	-	-	-	■	■	■	■	-	-	-	■	■	-	-	-	■	■
	Maxi	-	-	-	-	-	■	■	■	-	-	■	■	-	-	-	■	■
Filters LF 	Micro	■	■	■	-	-	-	-	-	■	■	-	-	-	-	-	■	-
	Mini	-	-	■	■	■	-	-	-	-	-	-	-	-	-	-	■	■
	Midi	-	-	-	■	■	■	■	-	-	-	-	-	-	-	-	■	■
	Maxi	-	-	-	-	-	■	■	■	-	-	-	-	-	-	-	■	■
Fine and micro filters LFMA/LFMB 	Micro	-	-	-	-	-	-	-	-	-	-	-	-	-	-	-	-	
	Mini	-	-	■	■	■	-	-	-	-	-	-	-	■	■	-	-	-
	Midi	-	-	-	■	■	■	■	-	-	-	-	-	■	■	-	-	-
	Maxi	-	-	-	-	-	■	■	■	-	-	-	-	■	■	-	-	-
Active carbon filters LFX 	Micro	-	-	-	-	-	-	-	-	-	-	-	-	-	-	-	-	
	Mini	-	-	■	■	■	-	-	-	-	-	-	-	-	-	-	-	-
	Midi	-	-	-	■	■	■	■	-	-	-	-	-	-	-	-	-	-
	Maxi	-	-	-	-	-	■	■	■	-	-	-	-	-	-	-	-	-
Filter combinations LFMBA 	Micro	-	-	-	-	-	-	-	-	-	-	-	-	-	-	-	-	
	Mini	-	-	■	■	■	-	-	-	-	-	-	-	■	■	-	-	-
	Midi	-	-	-	■	■	■	■	-	-	-	-	-	■	■	-	-	-
	Maxi	-	-	-	-	-	■	■	■	-	-	-	-	■	■	-	-	-
Pressure regulators LRS/LRS 	Micro	■	■	■	-	-	-	-	-	■	■	■	-	-	-	-	-	-
	Mini	-	-	■	■	■	-	-	-	-	-	■	■	-	-	-	-	-
	Midi	-	-	-	■	■	■	■	-	-	-	■	■	-	-	-	-	-
	Maxi	-	-	-	-	-	■	■	■	-	-	■	■	-	-	-	-	-

Service unit combinations FRC-K, D series, metal design



Product range overview D series service units, metal design

Type	Size	Bowl guard		Condensate drain			Pressure indication		Actuator lock		Supply voltage			Options			→ Page/ Internet
		Metal bowl guard	Plastic bowl	Manual rotary	Semi-automatic	Fully automatic	With pressure gauge	Without pressure gauge	Rotary knob with detent	Rotary knob with integrated lock	24 V DC	110 V AC	230 V AC	Directly actuated pressure regulator with integrated return flow function	Pilot actuated pressure regulator with integrated return flow function	Differential pressure indicator	
Service units																	
FRC/FRCS	Micro	-	■	■	■	-	■	■	■	-	-	-	-	-	-	-	frc
	Mini	■	-	■	-	■	■	■	■	■	-	-	-	-	-	-	
	Midi	■	-	■	-	■	■	■	■	■	-	-	-	-	-	-	
	Maxi	■	-	■	-	■	■	■	■	■	-	-	-	■	■	-	
Service unit combinations																	
FRC-K	Micro	-	-	-	-	-	-	-	-	-	-	-	-	-	-	-	6
	Mini	■	-	■	-	■	■	-	■	-	-	-	-	-	-	-	
	Midi	■	-	■	-	■	■	-	■	-	-	-	-	-	-	-	
	Maxi	■	-	■	-	■	■	-	■	-	-	-	-	■	■	-	
LFR-K LFRS-K	Micro	-	-	-	-	-	-	-	-	-	-	-	-	-	-	-	lfr
	Mini	■	-	■	-	■	■	-	■	■	■	-	-	-	-	-	
	Midi	■	-	■	-	■	■	-	■	■	■	-	-	-	-	-	
	Maxi	■	-	■	-	■	■	-	■	■	■	-	-	■	■	-	
Individual devices																	
Filter regulators LFR/LFRS	Micro	-	■	■	■	-	■	■	■	-	-	-	-	-	-	-	lfr
	Mini	■	-	■	-	■	■	■	■	■	-	-	-	-	-	-	
	Midi	■	-	■	-	■	■	■	■	■	-	-	-	-	-	-	
	Maxi	■	-	■	-	■	■	■	■	■	-	-	-	■	■	-	
Filters LF	Micro	-	■	■	■	-	-	-	-	-	-	-	-	-	-	-	lf
	Mini	■	-	■	-	■	-	-	-	-	-	-	-	-	-	-	
	Midi	■	-	■	-	■	-	-	-	-	-	-	-	-	-	-	
	Maxi	■	-	■	-	■	-	-	-	-	-	-	-	-	-	-	
Fine and micro filters LFMA/LFMB	Micro	-	-	-	-	-	-	-	-	-	-	-	-	-	-	-	lfma, lfmb
	Mini	■	-	■	-	■	-	-	-	-	-	-	-	-	-	■	
	Midi	■	-	■	-	■	-	-	-	-	-	-	-	-	-	■	
	Maxi	■	-	■	-	■	-	-	-	-	-	-	-	-	-	■	
Active carbon filters LFX	Micro	-	-	-	-	-	-	-	-	-	-	-	-	-	-	-	lfx
	Mini	■	-	-	-	-	-	-	-	-	-	-	-	-	-	-	
	Midi	■	-	-	-	-	-	-	-	-	-	-	-	-	-	-	
	Maxi	■	-	-	-	-	-	-	-	-	-	-	-	-	-	-	
Filter combinations LFMBA	Micro	-	-	-	-	-	-	-	-	-	-	-	-	-	-	-	lfmba
	Mini	■	-	■	-	■	-	-	-	-	-	-	-	-	-	■	
	Midi	■	-	■	-	■	-	-	-	-	-	-	-	-	-	■	
	Maxi	■	-	■	-	■	-	-	-	-	-	-	-	-	-	■	
Pressure regulators LR/LRS	Micro	-	-	-	-	-	■	■	■	-	-	-	-	-	-	-	lr
	Mini	-	-	-	-	-	■	■	■	■	-	-	-	■	-	-	
	Midi	-	-	-	-	-	■	■	■	■	-	-	-	■	-	-	
	Maxi	-	-	-	-	-	■	■	■	■	-	-	-	■	■	-	

Service unit combinations FRC-K, D series, metal design

FESTO

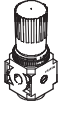
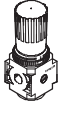
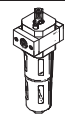
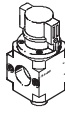
Product range overview D series service units, metal design

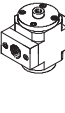
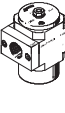
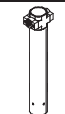
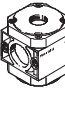
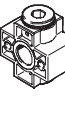
Type	Size	Pneumatic connection										Pressure regulation range [bar]		
		M5	M7	G1/8	G1/4	G3/8	G1/2	G3/4	G1	QS4	QS6	0.5 ... 7	0.5 ... 12	
Individual devices														
Pressure regulators LRB/LRBS		Micro	-											
		Mini	-	-	-	■	-	-	-	-	-	-	■	■
		Midi	-	-	-	-	■	-	-	-	-	-	■	■
		Maxi	-											
Pressure regulator combinations LRB-K		Micro	-											
		Mini	-	-	-	■	■	-	-	-	-	-	■	■
		Midi	-	-	-	-	■	■	-	-	-	-	■	■
		Maxi	-											
Lubricators LOE		Micro	■	■	■	-	-	-	-	-	■	■	-	-
		Mini	-	-	■	■	■	-	-	-	-	-	-	-
		Midi	-	-	-	■	■	■	■	-	-	-	-	-
		Maxi	-	-	-	-	-	■	■	■	-	-	-	-
On-off valves HE		Micro	-											
		Mini	-	-	■	■	■	-	-	-	-	-	-	-
		Midi	-	-	-	■	■	■	■	-	-	-	-	-
		Maxi	-	-	-	-	-	■	■	■	-	-	-	-
On-off valves, electrical HEE		Micro	-											
		Mini	-	-	■	■	■	-	-	-	-	-	-	-
		Midi	-	-	-	■	■	■	■	-	-	-	-	-
		Maxi	-	-	-	-	-	■	■	■	-	-	-	-
On-off valves, pneumatic HEP		Micro	-											
		Mini	-	-	■	■	■	-	-	-	-	-	-	-
		Midi	-	-	-	■	■	■	■	-	-	-	-	-
		Maxi	-	-	-	-	-	■	■	■	-	-	-	-
Soft-start valves HEL		Micro	-											
		Mini	-	-	■	■	■	-	-	-	-	-	-	-
		Midi	-	-	-	■	■	■	■	-	-	-	-	-
		Maxi	-	-	-	-	-	■	■	■	-	-	-	-
Membrane air dryers LDM1		Micro	-											
		Mini	-											
		Midi	-											
		Maxi	-	-	-	-	-	■	■	■	-	-	-	-
Branching modules FRM		Micro	-											
		Mini	-	-	■	■	■	-	-	-	-	-	-	-
		Midi	-	-	-	■	■	■	■	-	-	-	-	-
		Maxi	-	-	-	-	-	■	■	■	-	-	-	-
Distributor block FRZ		Micro	-											
		Mini	-											
		Midi	-											
		Maxi	-											

Service unit combinations FRC-K, D series, metal design

Product range overview D series service units, metal design

Type	Size	Bowl guard		Pressure indication		Actuator lock		Supply voltage			Options		→ Page/ Internet
		Metal bowl guard	Plastic bowl	With pressure gauge	Without pressure gauge	Rotary knob with detent	Rotary knob with integrated lock	24 V DC	110 V AC	230 V AC	Non-return function	Pressure switch	
Individual devices													
Pressure regulators LRB/LRBS	Micro	-	-	-	■	■	■	-	-	-	-	-	lrb
	Mini	-	-	-	■	■	■	-	-	-	-	-	
	Midi	-	-	-	■	■	■	-	-	-	-	-	
	Maxi	-	-	-	■	■	■	-	-	-	-	-	
Pressure regulator combinations LRB-K	Micro	-	-	-	■	■	-	-	-	-	-	-	lrb
	Mini	-	-	-	■	■	-	-	-	-	-	-	
	Midi	-	-	-	■	■	-	-	-	-	-	-	
	Maxi	-	-	-	■	■	-	-	-	-	-	-	
Lubricators LOE	Micro	-	■	-	■	-	-	-	-	-	-	-	loe
	Mini	■	-	-	■	-	-	-	-	-	-	-	
	Midi	■	-	-	■	-	-	-	-	-	-	-	
	Maxi	■	-	-	■	-	-	-	-	-	-	-	
On-off valves HE	Micro	-	-	-	■	■	-	-	-	-	-	-	he
	Mini	-	-	-	■	■	-	-	-	-	-	-	
	Midi	-	-	-	■	■	-	-	-	-	-	-	
	Maxi	-	-	-	■	■	-	-	-	-	-	-	
On-off valves, electrical HEE	Micro	-	-	-	■	-	-	■	■	■	-	-	hee
	Mini	-	-	-	■	-	-	■	■	■	-	-	
	Midi	-	-	-	■	-	-	■	■	■	-	-	
	Maxi	-	-	-	■	-	-	■	■	■	-	-	
On-off valves, pneumatic HEP	Micro	-	-	-	■	-	-	-	-	-	-	-	hep
	Mini	-	-	-	■	-	-	-	-	-	-	-	
	Midi	-	-	-	■	-	-	-	-	-	-	-	
	Maxi	-	-	-	■	-	-	-	-	-	-	-	
Soft-start valves HEL	Micro	-	-	-	■	-	-	-	-	-	-	-	hel
	Mini	-	-	-	■	-	-	-	-	-	-	-	
	Midi	-	-	-	■	-	-	-	-	-	-	-	
	Maxi	-	-	-	■	-	-	-	-	-	-	-	
Membrane air dryers LDM1	Micro	-	-	-	■	-	-	-	-	-	-	-	ldm1
	Mini	-	-	-	■	-	-	-	-	-	-	-	
	Midi	-	-	-	■	-	-	-	-	-	-	-	
	Maxi	■	-	-	■	-	-	-	-	-	-	-	
Branching modules FRM	Micro	-	-	-	■	-	-	-	-	-	■	■	frm
	Mini	-	-	-	■	-	-	-	-	-	■	■	
	Midi	-	-	-	■	-	-	-	-	-	■	■	
	Maxi	-	-	-	■	-	-	-	-	-	■	■	
Distributor block FRZ	Micro	-	-	-	■	-	-	-	-	-	-	-	frz
	Mini	-	-	-	■	-	-	-	-	-	-	-	
	Midi	-	-	-	■	-	-	-	-	-	-	-	
	Maxi	-	-	-	■	-	-	-	-	-	-	-	

Service unit combinations FRC-K, D series, metal design

Product range overview

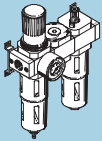
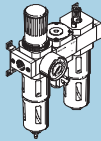
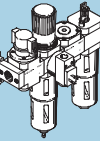
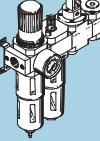
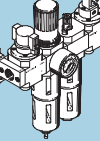
FRC Rotary knob with detent	 KA	 KB	 KC	 KE	 KF
Individual devices					
On-off valve, manual	-	-	■	-	■
Filter regulator with pressure gauge	■	■	■	■	■
Branching module	■	-	-	-	-
Branching module with pressure switch	-	■	■	-	■
Lubricator	■	■	■	■	■
On-off valve with solenoid coil 24 V DC	-	-	-	■	■
Soft-start valve	-	-	-	■	■
Mounting bracket	■	■	■	■	■
➔ Page/Internet	9	12	15	18	21

Service unit combinations FRC-K, D series, metal design

Peripherals overview

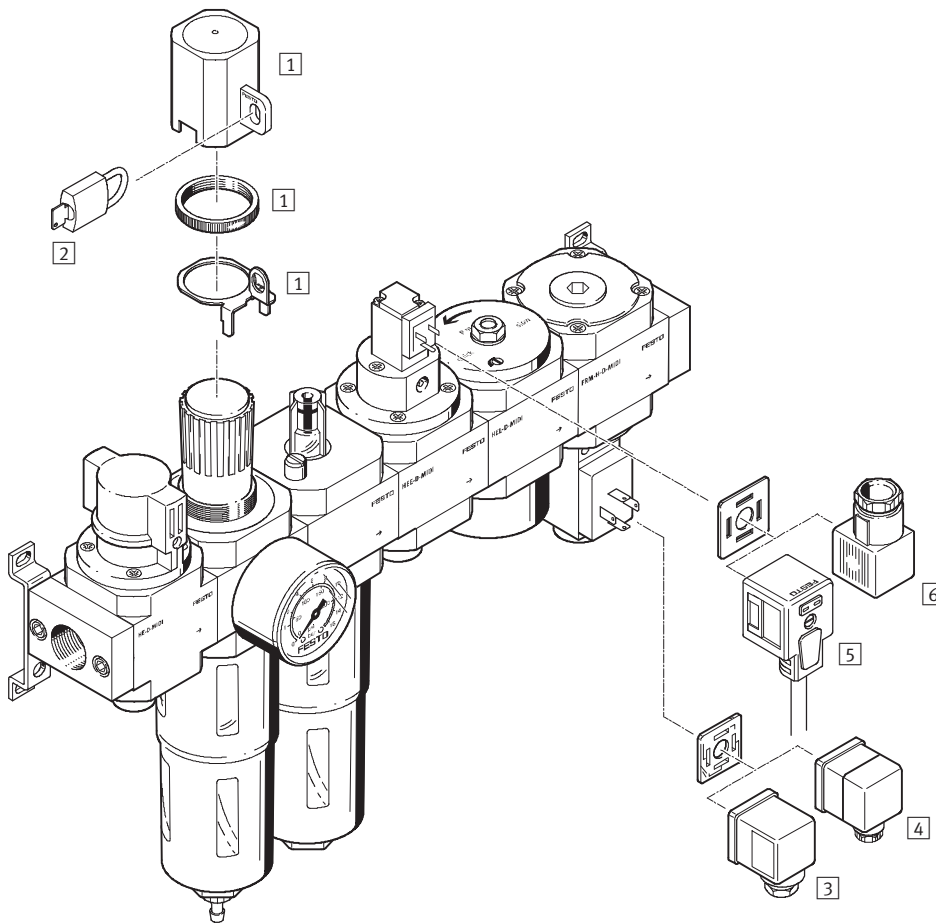

-  - Note

The choice of accessories depends on the selected service unit combination. The example shows the service unit combination FRC-KF.

Range of accessories
 → Peripherals pages of the individual devices

Mounting attachments and accessories		→ Page/ Internet
1	Regulator lock LRVS	lrvs-d
2	Padlock LRVS	lrvs-d
3	Plug socket MSSD-C	24
4	Angled plug socket PEV-...-WD-LED	24
5	Plug socket with cable KMEB-1	24
6	Plug socket MSSD-EB	24

Service unit combinations FRC-K, D series, metal design

Type codes

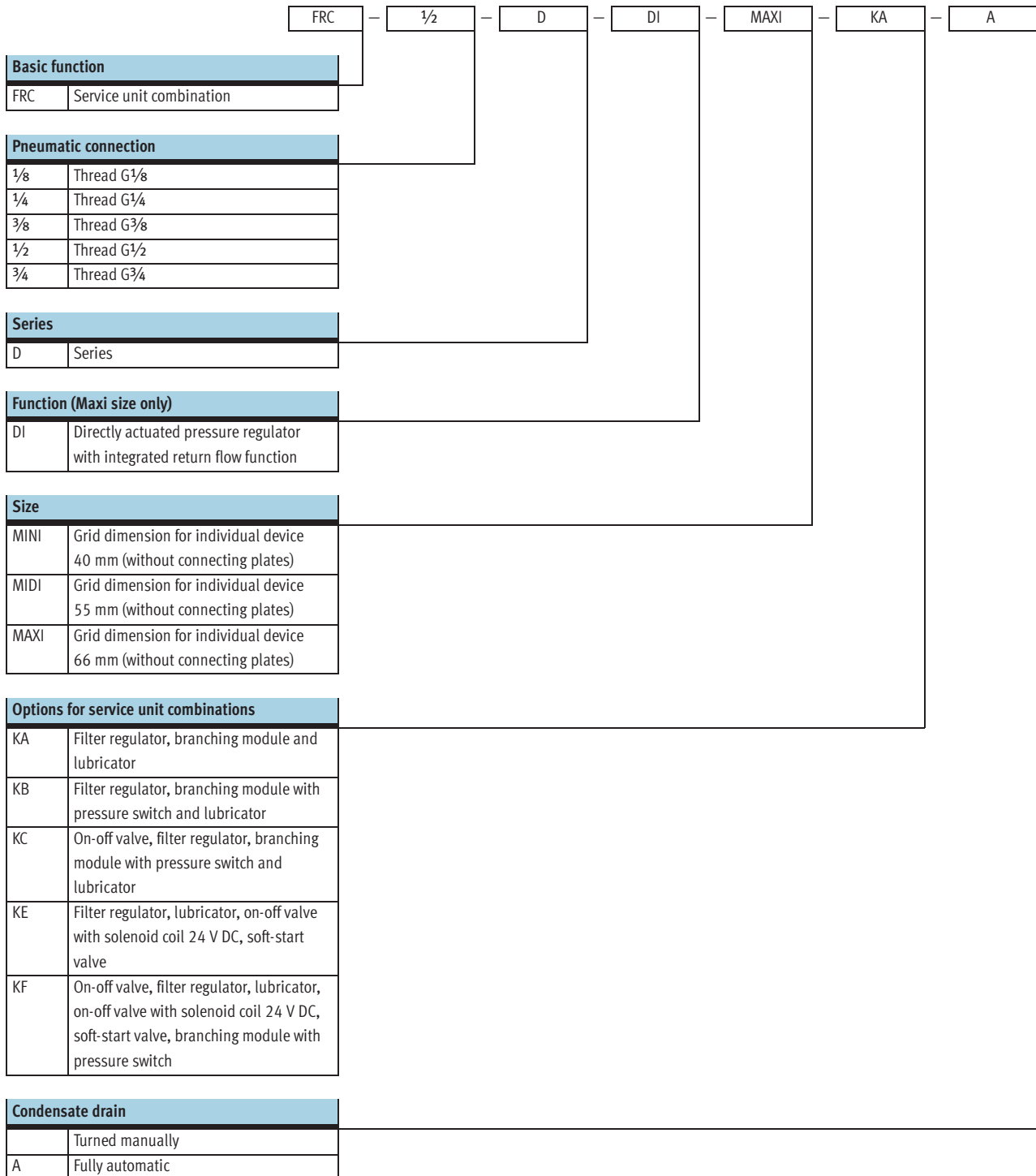

Service unit combinations FRC-KA, D series, metal design

Technical data combination FRC-KA

Function

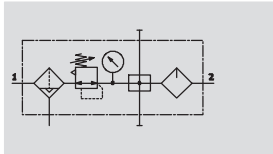

- Flow rate
650 ... 8200 l/min
- Temperature range
-10 ... +60 °C
- Input pressure
1 ... 16 bar

- Filter regulator LFR
 - grade of filtration 40 µm
 - metal bowl guard
 - condensate drain, turned manually or fully automatic
 - rotary knob with detent
 - pressure gauge
- Branching module FRM
- Lubricator LOE
 - metal bowl guard
- Mounting accessories

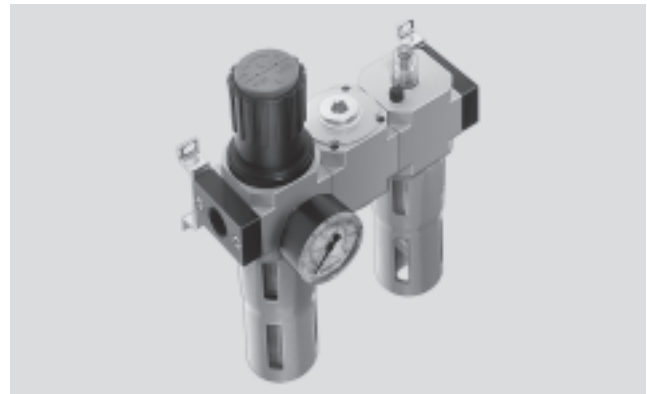

- For lubricated and unlubricated compressed air
- Two connections for unlubricated compressed air supply
- One connection for lubricated compressed air supply

General technical data							
Size	Mini		Midi			Maxi	
Pneumatic connection	G1/8	G1/4	G1/4	G3/8	G1/2	G1/2	G3/4
Operating medium	Compressed air						
Type of mounting	Via accessories						
	In-line installation						
Assembly position	Vertical ±5°						
Grade of filtration [µm]	40						
Max. hysteresis [bar]	0.25	0.2	0.25	0.35	0.3	0.1	0.2
Pressure regulation range [bar]	0.5 ... 12						
Pressure indication	Via pressure gauge						
Max. condensate volume [cm³]	22		43			80 ¹⁾	
Input pressure [bar]							
Condensate drain	turned manually	1 ... 16					
	fully automatic	2 ... 12					

1) The max. condensate volume for the FRC...-DI-MAXI-KA is 43 cm³.
 -||- Note: This product conforms to ISO 1179-1 and to ISO 228-1

Service unit combinations FRC-KA, D series, metal design

Technical data combination FRC-KA

Standard nominal flow rate ¹⁾ qnN [l/min]					
Connection	G1/8	G1/4	G3/8	G1/2	G3/4
Mini					
FRC-...-D-...	650	980	-	-	-
Midi					
FRC-...-D-...	-	1400	2100	2500	-
Maxi					
FRC-...-D-...	-	-	-	7500	8200
Maxi – Directly actuated pressure regulator with integrated return flow function					
FRC-...-D-DI-...	-	-	-	5200	5800

1) Measured at p1 = 10 bar, p2 = 6 bar and Δp = 1 bar.

Ambient conditions		Mini	Midi	Maxi
Size				
Ambient temperature	[°C]	-10 ... +60		
Temperature of medium	[°C]	-10 ... +60		
Corrosion resistance class	CRC ¹⁾	2		

1) Corrosion resistance class 2 according to Festo standard 940 070
 Components requiring moderate corrosion resistance. Externally visible parts with primarily decorative surface requirements which are in direct contact with a normal industrial environment or media such as coolants or lubricating agents.

Weight [g]				
Size	Mini	Midi	Maxi	
			D	D-DI
FRC	1000	2400	3500	3700

 Note
 Materials → Technical data of the individual devices

Standard flow rate qn as a function of the output pressure p2

FRC-1/2-D-DI-MAXI-KA(-A)

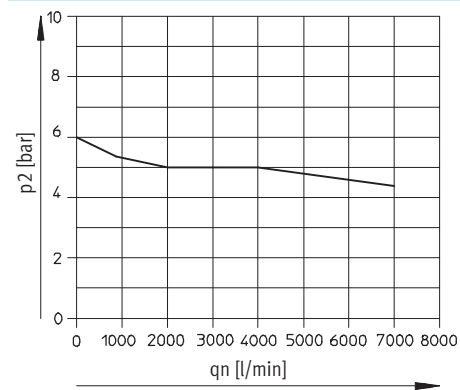

Primary pressure p1 = 10 bar

Service unit combinations FRC-KA, D series, metal design

Technical data combination FRC-KA

Dimensions Download CAD data → www.festo.com

FRC-...-KA

Manually turned condensate drain Fully automatic condensate drain

3 Installation dimensions → Flow direction

Type	B5	B6	D1	H1	H2	H3	L1	L2	L3	L4	L5	L8	L9	L10	T1	T2
Mini																
FRC-...-D-MINI-KA (-A)	144	132	4.3	43	17.5	17.5	193	124	60	68	100	15	19	3	39	95
Midi																
FRC-...-D-MIDI-KA (-A)	195	180	5.3	70	24.5	35.5	250	152	80	99	120	15	19	3	47	114
Maxi																
FRC-...-D-MAXI-KA (-A)	228	212	5.3	70	24.5	35.5	252	171	90	82	150	15	19	3	53	126
FRC-...-D-DI-MAXI-KA (-A)							275			105						

Ordering data					
Size	Connection	Condensate drain turned manually		Condensate drain fully automatic	
		Part No.	Type	Part No.	Type
Mini	G1/8	185791	FRC-1/8-D-MINI-KA	185792	FRC-1/8-D-MINI-KA-A
	G1/4	185793	FRC-1/4-D-MINI-KA	185794	FRC-1/4-D-MINI-KA-A
Midi	G1/4	185795	FRC-1/4-D-MIDI-KA	185796	FRC-1/4-D-MIDI-KA-A
	G3/8	185797	FRC-3/8-D-MIDI-KA	185798	FRC-3/8-D-MIDI-KA-A
	G1/2	185799	FRC-1/2-D-MIDI-KA	185800	FRC-1/2-D-MIDI-KA-A
Maxi	G1/2	186053	FRC-1/2-D-MAXI-KA	186054	FRC-1/2-D-MAXI-KA-A
	G3/4	185801	FRC-3/4-D-MAXI-KA	185802	FRC-3/4-D-MAXI-KA-A
Directly actuated pressure regulator with integrated return flow function					
Maxi	G1/2	192468	FRC-1/2-D-DI-MAXI-KA	192478	FRC-1/2-D-DI-MAXI-KA-A
	G3/4	192473	FRC-3/4-D-DI-MAXI-KA	192483	FRC-3/4-D-DI-MAXI-KA-A

• Note: This product conforms to ISO 1179-1 and to ISO 228-1

Service unit combinations FRC-KB, D series, metal design

Technical data combination FRC-KB

Function

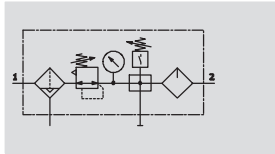

- - Flow rate
650 ... 8200 l/min
- - Temperature range
-10 ... +60 °C
- - Input pressure
1 ... 16 bar

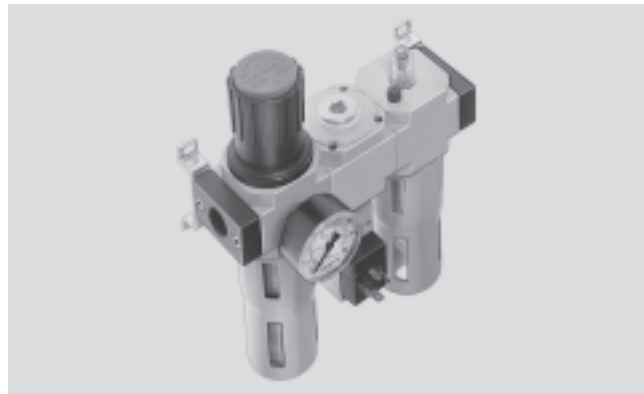

- Filter regulator LFR
 - grade of filtration 40 µm
 - metal bowl guard
 - condensate drain, turned manually or fully automatic
 - rotary knob with detent
 - pressure gauge
- Branching module FRM
 - Pressure switch without display
- Lubricator LOE
 - metal bowl guard
- Mounting accessories

- Electrical pressure monitoring with adjustable switching pressure
- For lubricated and unlubricated compressed air
- One connection for unlubricated compressed air supply
- One connection for lubricated compressed air supply

General technical data							
Size	Mini		Midi			Maxi	
Pneumatic connection	G1/8	G1/4	G1/4	G3/8	G1/2	G1/2	G3/4
Operating medium	Compressed air						
Type of mounting	Via accessories In-line installation						
Assembly position	Vertical ±5°						
Grade of filtration [µm]	40						
Max. hysteresis [bar]	0.25	0.2	0.25	0.35	0.35	0.1	0.2
Pressure regulation range [bar]	0.5 ... 12						
Pressure indication	Via pressure gauge						
Max. condensate volume [cm ³]	22		43			80 ¹⁾	
Input pressure [bar]							
Condensate drain	turned manually	1 ... 16					
	fully automatic	2 ... 12					

1) The max. condensate volume for the FRC...-DI-MAXI-KB is 43 cm³.
 - - Note: This product conforms to ISO 1179-1 and to ISO 228-1

Service unit combinations FRC-KB, D series, metal design

Technical data combination FRC-KB

Standard nominal flow rate ¹⁾ qnN [l/min]					
Connection	G1/8	G1/4	G3/8	G1/2	G3/4
Mini					
FRC-...-D-...	650	980	-	-	-
Midi					
FRC-...-D-...	-	1400	2100	2500	-
Maxi					
FRC-...-D-...	-	-	-	7500	8200
Maxi – Directly actuated pressure regulator with integrated return flow function					
FRC-...-D-DI-...	-	-	-	5000	6000

1) Measured at p1 = 10 bar, p2 = 6 bar and Δp = 1 bar.

Ambient conditions			
Size	Mini	Midi	Maxi
Ambient temperature [°C]	-10 ... +60		
Temperature of medium [°C]	-10 ... +60		
Corrosion resistance class CRC ¹⁾	2		

1) Corrosion resistance class 2 according to Festo standard 940 070
 Components requiring moderate corrosion resistance. Externally visible parts with primarily decorative surface requirements which are in direct contact with a normal industrial environment or media such as coolants or lubricating agents.

Weight [g]				
Size	Mini	Midi	Maxi	
			D	D-DI
FRC	1200	2600	3500	3700

 Note
 Materials → Technical data of the individual devices

Standard flow rate qn as a function of the output pressure p2

FRC-1/2-D-DI-MAXI-KB(-A)

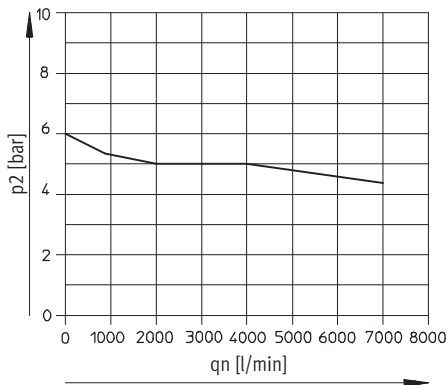

Primary pressure p1 = 10 bar

Service unit combinations FRC-KB, D series, metal design

Technical data combination FRC-KB

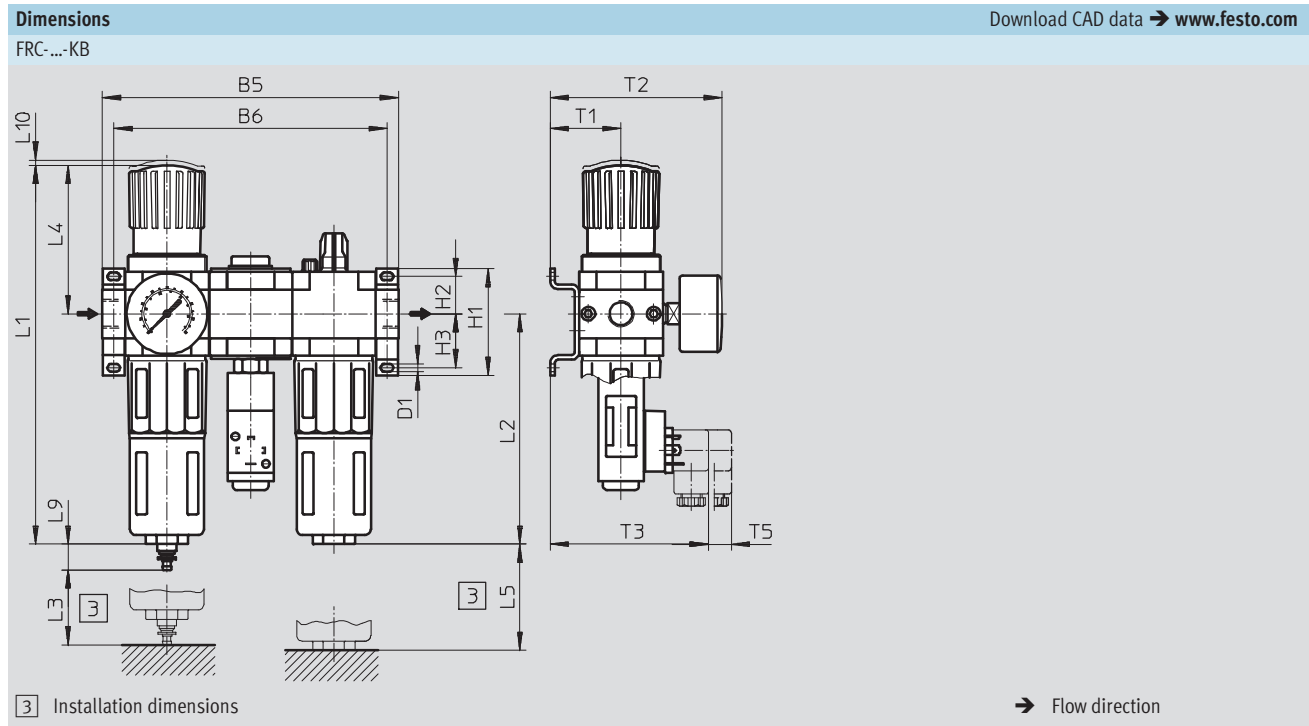

Type	B5	B6	D1	H1	H2	H3	L1	L2	L3	L4	L5	L9	L10	T1	T2	T3	T5
Mini																	
FRC-...-D-MINI-KB (-A)	144	132	4.3	43	17.5	17.5	193	124	60	68	100	19	3	39	95	97	15
Midi																	
FRC-...-D-MIDI-KB (-A)	195	180	5.3	70	24.5	35.5	250	152	80	99	120	19	3	47	114	105	15
Maxi																	
FRC-...-D-MAXI-KB (-A)	228	212	5.3	70	24.5	35.5	252	171	90	82	150	19	3	53	126	111	15
FRC-...-D-DI-MAXI-KB (-A)							275			105							

Ordering data					
Size	Connection	Condensate drain turned manually		Condensate drain fully automatic	
		Part No.	Type	Part No.	Type
Mini	G1/8	185803	FRC-1/8-D-MINI-KB	185804	FRC-1/8-D-MINI-KB-A
	G1/4	185805	FRC-1/4-D-MINI-KB	185806	FRC-1/4-D-MINI-KB-A
Midi	G1/4	185807	FRC-1/4-D-MIDI-KB	185808	FRC-1/4-D-MIDI-KB-A
	G3/8	185809	FRC-3/8-D-MIDI-KB	185810	FRC-3/8-D-MIDI-KB-A
	G1/2	185811	FRC-1/2-D-MIDI-KB	185812	FRC-1/2-D-MIDI-KB-A
Maxi	G1/2	186055	FRC-1/2-D-MAXI-KB	186056	FRC-1/2-D-MAXI-KB-A
	G3/4	185813	FRC-3/4-D-MAXI-KB	185814	FRC-3/4-D-MAXI-KB-A
Directly actuated pressure regulator with integrated return flow function					
Maxi	G1/2	192469	FRC-1/2-D-DI-MAXI-KB	192479	FRC-1/2-D-DI-MAXI-KB-A
	G3/4	192474	FRC-3/4-D-DI-MAXI-KB	192484	FRC-3/4-D-DI-MAXI-KB-A

• Note: This product conforms to ISO 1179-1 and to ISO 228-1

Service unit combinations FRC-KC, D series, metal design

Technical data combination FRC-KC

Function

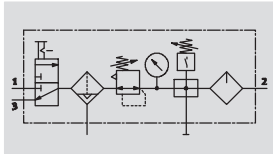

- Flow rate
640 ... 7800 l/min
- Temperature range
-10 ... +60 °C
- Input pressure
1 ... 16 bar

- On-off valve HE
 - manually actuated
- Filter regulator LFR
 - grade of filtration 40 µm
 - metal bowl guard
 - condensate drain, turned manually or fully automatic
 - rotary knob with detent
 - pressure gauge
- Branching module FRM
 - pressure switch without display
- Lubricator LOE
 - metal bowl guard
- Mounting accessories

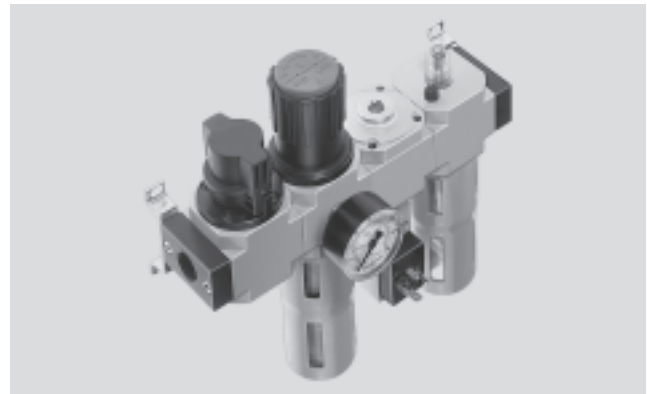

- To ensure safe venting of the system, an additional quick exhaust valve is necessary at the output of the service unit combination
- Electrical pressure monitoring with adjustable switching pressure
- The system is vented when supply air is closed
- For lubricated and unlubricated compressed air
- One connection for unlubricated compressed air supply
- One connection for lubricated compressed air supply

General technical data							
Size	Mini		Midi			Maxi	
Pneumatic connection	G1/8	G1/4	G1/4	G3/8	G1/2	G1/2	G3/4
Operating medium	Compressed air						
Type of mounting	Via accessories						
	In-line installation						
Assembly position	Vertical ±5°						
Grade of filtration [µm]	40						
Max. hysteresis [bar]	0.2	0.2	0.4	0.3	0.3	0.15	0.15
Pressure regulation range [bar]	0.5 ... 12						
Pressure indication	Via pressure gauge						
Max. condensate volume [cm³]	22		43			80 ¹⁾	
Input pressure [bar]							
Condensate drain	turned manually	1 ... 16					
	fully automatic	1.5 ... 12					

1) The max. condensate volume for the FRC...-DI-MAXI-KC is 43 cm³.
 - - Note: This product conforms to ISO 1179-1 and to ISO 228-1

Service unit combinations FRC-KC, D series, metal design

Technical data combination FRC-KC

Standard nominal flow rate ¹⁾ qnN [l/min]					
Connection	G ¹ / ₈	G ¹ / ₄	G ³ / ₈	G ¹ / ₂	G ³ / ₄
Mini					
FRC-...-D-...	640	870	-	-	-
Midi					
FRC-...-D-...	-	1320	1870	2400	-
Maxi					
FRC-...-D-...	-	-	-	6600	7800
Maxi – Directly actuated pressure regulator with integrated return flow function					
FRC-...-D-DI-...	-	-	-	4800	5400

1) Measured at p₁ = 10 bar, p₂ = 6 bar and Δp = 1 bar.

Ambient conditions		Mini	Midi	Maxi
Size				
Ambient temperature	[°C]	-10 ... +60		
Temperature of medium	[°C]	-10 ... +60		
Corrosion resistance class	CRC ¹⁾	2		

1) Corrosion resistance class 2 according to Festo standard 940 070

Components requiring moderate corrosion resistance. Externally visible parts with primarily decorative surface requirements which are in direct contact with a normal industrial environment or media such as coolants or lubricating agents.

Weight [g]				
Size	Mini	Midi	Maxi	
			D	D-DI
FRC	1400	3000	4600	4800

-  Note
Materials → Technical data of the individual devices

Standard flow rate qn as a function of the output pressure p₂

FRC-1/2-D-DI-MAXI-KC(-A)

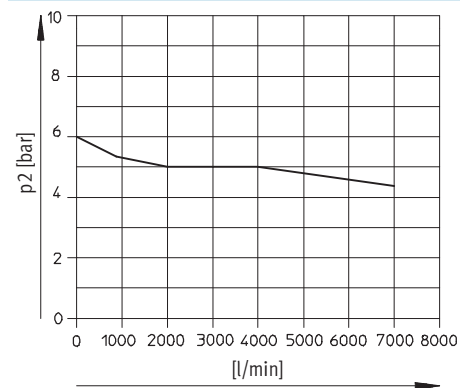

Primary pressure p₁ = 10 bar

Service unit combinations FRC-KC, D series, metal design

Technical data combination FRC-KC

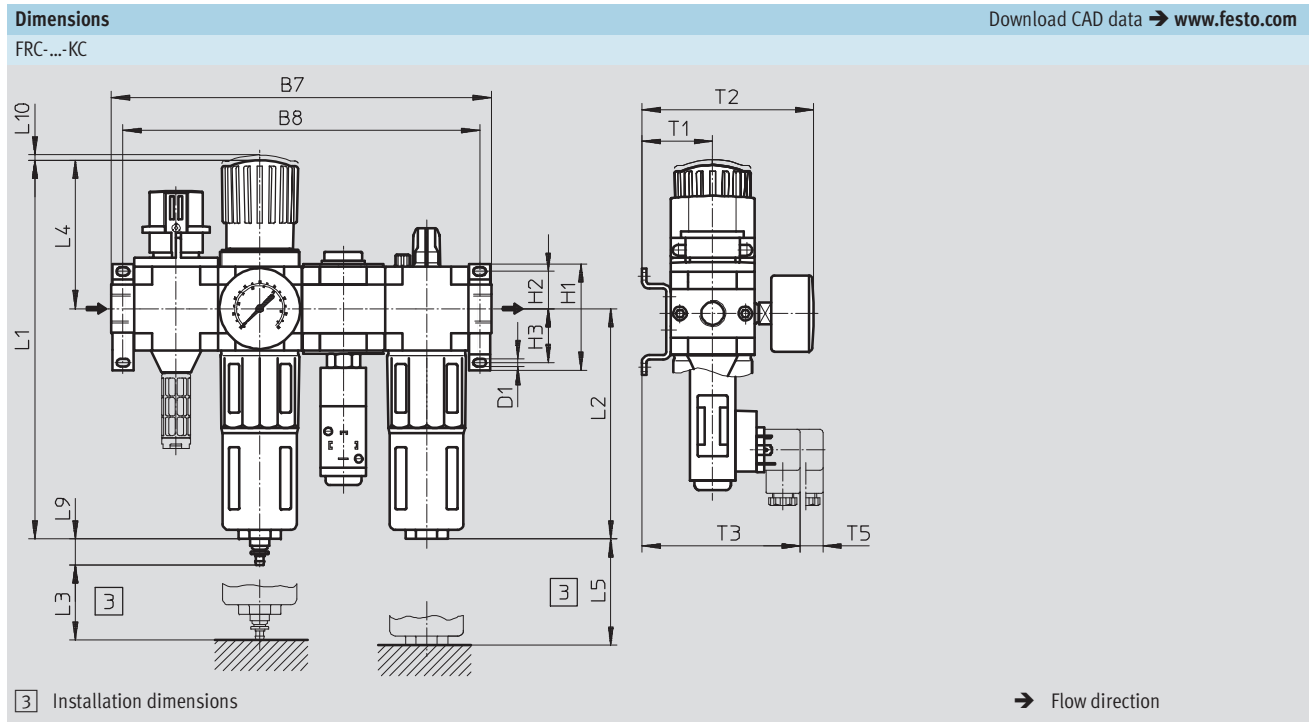

Type	B7	B8	D1	H1	H2	H3	L1	L2	L3	L4	L5	L9	L10	T1	T2	T3	T5
Mini																	
FRC-...-D-MINI-KC (-A)	184	172	4.3	43	17.5	17.5	193	124	60	68	100	19	3	39	95	97	15
Midi																	
FRC-...-D-MIDI-KC (-A)	250	235	5.3	70	24.5	35.5	250	152	80	99	120	19	3	47	114	105	15
Maxi																	
FRC-...-D-MAXI-KC (-A)	294	278	5.3	70	24.5	35.5	252	171	90	82	150	19	3	53	126	111	15
FRC-...-D-DI-MAXI-KC (-A)							275			105							

Ordering data					
Size	Connection	Condensate drain turned manually		Condensate drain fully automatic	
		Part No.	Type	Part No.	Type
Mini	G1/8	185815	FRC-1/8-D-MINI-KC	185816	FRC-1/8-D-MINI-KC-A
	G1/4	185817	FRC-1/4-D-MINI-KC	185818	FRC-1/4-D-MINI-KC-A
Midi	G1/4	185819	FRC-1/4-D-MIDI-KC	185820	FRC-1/4-D-MIDI-KC-A
	G3/8	185821	FRC-3/8-D-MIDI-KC	185822	FRC-3/8-D-MIDI-KC-A
	G1/2	185823	FRC-1/2-D-MIDI-KC	185824	FRC-1/2-D-MIDI-KC-A
Maxi	G1/2	186057	FRC-1/2-D-MAXI-KC	186058	FRC-1/2-D-MAXI-KC-A
	G3/4	185825	FRC-3/4-D-MAXI-KC	185826	FRC-3/4-D-MAXI-KC-A
Directly actuated pressure regulator with integrated return flow function					
Maxi	G1/2	192470	FRC-1/2-D-DI-MAXI-KC	192480	FRC-1/2-D-DI-MAXI-KC-A
	G3/4	192475	FRC-3/4-D-DI-MAXI-KC	192485	FRC-3/4-D-DI-MAXI-KC-A

• Note: This product conforms to ISO 1179-1 and to ISO 228-1

Service unit combinations FRC-KE, D series, metal design

Technical data combination FRC-KE

Function

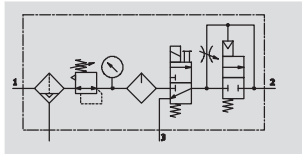

- - Flow rate
550 ... 6000 l/min
- - Temperature range
-10 ... +60 °C
- - Input pressure
3 ... 16 bar

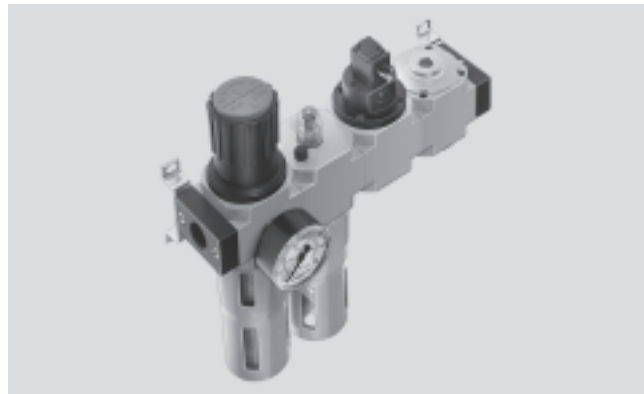

- Filter regulator LFR
 - grade of filtration 40 µm
 - metal bowl guard
 - condensate drain, turned manually or fully automatic
 - rotary knob with detent
 - pressure gauge
- Lubricator LOE
 - metal bowl guard
- On-off valve HEE
 - solenoid actuated
 - 24 V DC
- Soft-start valve HEL
 - pneumatically actuated
- Mounting accessories

- Gradual pressure build-up prevents sudden, unpredictable movements
- For lubricated compressed air
- When supply pressure is closed, quick venting ensures rapid pressure reduction

General technical data							
Size	Mini		Midi			Maxi	
Pneumatic connection	G1/8	G1/4	G1/4	G3/8	G1/2	G1/2	G3/4
Operating medium	Compressed air						
Type of mounting	Via accessories						
	In-line installation						
Assembly position	Vertical ±5°						
Grade of filtration [µm]	40						
Max. hysteresis [bar]	0.15	0.18	0.25	0.35	0.4	0.3	0.3
Pressure regulation range [bar]	2.5 ... 12						
Pressure indication	Via pressure gauge						
Max. condensate volume [cm ³]	22		43			80 ¹⁾	
Input pressure [bar]							
Condensate drain	turned manually		3 ... 16				
	fully automatic		3 ... 12				

1) The max. condensate volume for the FRC-...-DI-MAXI-KE is 43 cm³.

- - Note: This product conforms to ISO 1179-1 and to ISO 228-1

Service unit combinations FRC-KE, D series, metal design

Technical data combination FRC-KE

Standard nominal flow rate ¹⁾ qnN [l/min]					
Connection	G1/8	G1/4	G3/8	G1/2	G3/4
Mini					
FRC-...-D-...	550	650	-	-	-
Midi					
FRC-...-D-...	-	1100	1420	1590	-
Maxi					
FRC-...-D-...	-	-	-	3500	3800
Maxi – Directly actuated pressure regulator with integrated return flow function					
FRC-...-D-DI-...	-	-	-	5000	6000

1) Measured at p1 = 10 bar, p2 = 6 bar and Δp = 1 bar.

Ambient conditions			
Size	Mini	Midi	Maxi
Ambient temperature [°C]	-10 ... +60		
Temperature of medium [°C]	-10 ... +60		
Corrosion resistance class CRC ¹⁾	2		

1) Corrosion resistance class 2 according to Festo standard 940 070
 Components requiring moderate corrosion resistance. Externally visible parts with primarily decorative surface requirements which are in direct contact with a normal industrial environment or media such as coolants or lubricating agents.

Weight [g]				
Size	Mini	Midi	Maxi	
			D	D-DI
FRC	1200	2800	4200	4400

 Note
 Materials → Technical data of the individual devices

Standard flow rate qn as a function of the output pressure p2

FRC-1/2-D-DI-MAXI-KE(-A)

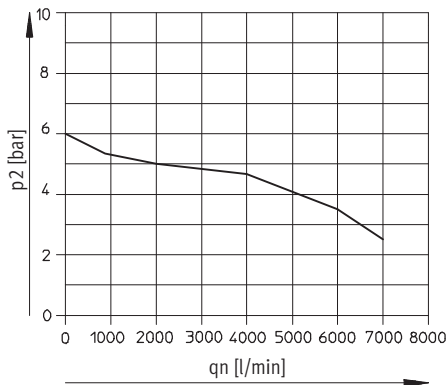

Primary pressure p1 = 10 bar

Service unit combinations FRC-KE, D series, metal design

Technical data combination FRC-KE

Dimensions Download CAD data → www.festo.com

FRC-...-KE

3 Installation dimensions → Flow direction

Type	B7	B8	D1	H1	H2	H3	L1	L2	L3	L4	L5	L9	L10	T1	T2	T4	T5
Mini																	
FRC-...-D-MINI-KE (-A)	184	172	4.3	43	17.5	17.5	193	124	60	68	100	19	3	39	95	78	15
Midi																	
FRC-...-D-MIDI-KE (-A)	250	235	5.3	70	24.5	35.5	250	152	80	99	120	19	3	47	114	86	15
Maxi																	
FRC-...-D-MAXI-KE (-A)	294	278	5.3	70	24.5	35.5	252	171	90	82	150	19	3	53	126	92	15
FRC-...-D-DI-MAXI-KE (-A)							275			105							

Ordering data					
Size	Connection	Condensate drain turned manually		Condensate drain fully automatic	
		Part No.	Type	Part No.	Type
Mini	G1/8	185827	FRC-1/8-D-MINI-KE	185828	FRC-1/8-D-MINI-KE-A
	G1/4	185829	FRC-1/4-D-MINI-KE	185830	FRC-1/4-D-MINI-KE-A
Midi	G1/4	185831	FRC-1/4-D-MIDI-KE	185832	FRC-1/4-D-MIDI-KE-A
	G3/8	185833	FRC-3/8-D-MIDI-KE	185834	FRC-3/8-D-MIDI-KE-A
	G1/2	185835	FRC-1/2-D-MIDI-KE	185836	FRC-1/2-D-MIDI-KE-A
Maxi	G1/2	186059	FRC-1/2-D-MAXI-KE	186060	FRC-1/2-D-MAXI-KE-A
	G3/4	185837	FRC-3/4-D-MAXI-KE	185838	FRC-3/4-D-MAXI-KE-A
Directly actuated pressure regulator with integrated return flow function					
Maxi	G1/2	192471	FRC-1/2-D-DI-MAXI-KE	192481	FRC-1/2-D-DI-MAXI-KE-A
	G3/4	192476	FRC-3/4-D-DI-MAXI-KE	192486	FRC-3/4-D-DI-MAXI-KE-A

|| Note: This product conforms to ISO 1179-1 and to ISO 228-1

Service unit combinations FRC-KF, D series, metal design

Technical data combination FRC-KF

Function

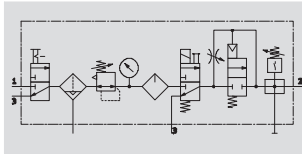

- Flow rate
530 ... 6000 l/min
- Temperature range
-10 ... +60 °C
- Input pressure
3 ... 16 bar

- On-off valve HE
 - manually actuated
- Filter regulator LFR
 - grade of filtration 40 µm
 - metal bowl guard
 - condensate drain, turned manually or fully automatic
 - rotary knob with detent
 - pressure gauge
- Lubricator LOE
 - metal bowl guard
- On-off valve HEE
 - solenoid actuated
 - 24 V DC
- Soft-start valve HEL
 - pneumatically actuated
- Branching module FRM
 - pressure switch without display
- Mounting accessories

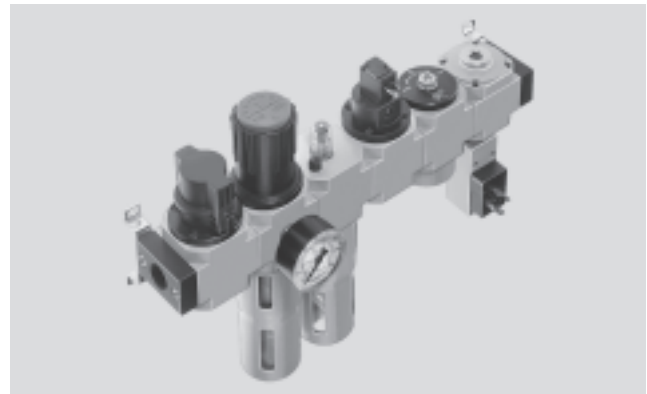

- Gradual pressure build-up prevents sudden, unpredictable movements
- To ensure safe venting of the system, an additional quick exhaust valve is necessary at the output of the service unit combination
- For lubricated compressed air
- Two branch connections are available
- Supply pressure can be opened and closed

General technical data							
Size	Mini		Midi			Maxi	
Pneumatic connection	G1/8	G1/4	G1/4	G3/8	G1/2	G1/2	G3/4
Operating medium	Compressed air						
Type of mounting	Via accessories						
	In-line installation						
Assembly position	Vertical ±5°						
Grade of filtration [µm]	40						
Max. hysteresis [bar]	0.2	0.3	0.4	0.3	0.35	0.25	0.3
Pressure regulation range [bar]	2.5 ... 12						
Pressure indication	Via pressure gauge						
Max. condensate volume [cm ³]	22		43			80 ¹⁾	
Input pressure [bar]							
Condensate drain	turned manually	3 ... 16					
	fully automatic	3 ... 12					

1) The max. condensate volume for the FRC...-DI-MAXI-KF is 43 cm³.

- - Note: This product conforms to ISO 1179-1 and to ISO 228-1

Service unit combinations FRC-KF, D series, metal design

Technical data combination FRC-KF

Standard nominal flow rate ¹⁾ qnN [l/min]					
Connection	G1/8	G1/4	G3/8	G1/2	G3/4
Mini					
FRC-...-D-...	530	620	-	-	-
Midi					
FRC-...-D-...	-	1060	1150	1220	-
Maxi					
FRC-...-D-...	-	-	-	3400	3700
Maxi – Directly actuated pressure regulator with integrated return flow function					
FRC-...-D-DI-...	-	-	-	5000	6000

1) Measured at p1 = 10 bar, p2 = 6 bar and Δp = 1 bar.

Ambient conditions			
Size	Mini	Midi	Maxi
Ambient temperature [°C]	-10 ... +60		
Temperature of medium [°C]	-10 ... +60		
Corrosion resistance class CRC ¹⁾	2		

1) Corrosion resistance class 2 according to Festo standard 940 070
 Components requiring moderate corrosion resistance. Externally visible parts with primarily decorative surface requirements which are in direct contact with a normal industrial environment or media such as coolants or lubricating agents.

Weight [g]				
Size	Mini	Midi	Maxi	
			D	D-DI
FRC	1800	4000	6300	6500

 Note
 Materials → Technical data of the individual devices

Standard flow rate qn as a function of the output pressure p2

FRC-1/2-D-DI-MAXI-KF(-A)

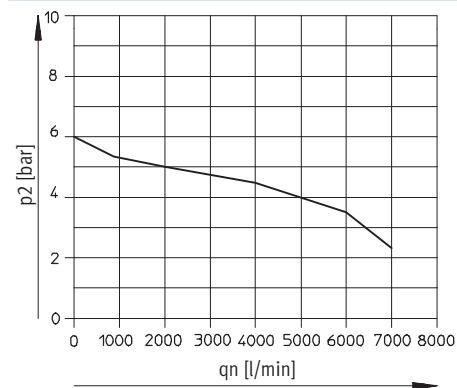

Primary pressure p1 = 10 bar

Service unit combinations FRC-KF, D series, metal design

Technical data combination FRC-KF

Dimensions Download CAD data → www.festo.com

FRC-...-KF

3 Installation dimensions → Flow direction

Type	B9	B10	D1	H1	H2	H3	L1	L2	L3	L4	L5	L9	L10	T1	T2	T3	T4	T5
Mini																		
FRC-...-D-MINI-KF (-A)	264	252	4.3	43	17.5	17.5	193	124	60	68	100	19	3	39	95	97	78	15
Midi																		
FRC-...-D-MIDI-KF (-A)	360	344	5.3	70	24.5	35.5	250	152	80	99	120	19	3	47	114	105	86	15
Maxi																		
FRC-...-D-MAXI-KF (-A)	426	410	5.3	70	24.5	35.5	252	171	90	82	150	19	3	53	126	111	92	15
FRC-...-D-DI-MAXI-KF (-A)							275			105								

Ordering data					
Size	Connection	Condensate drain turned manually		Condensate drain fully automatic	
		Part No.	Type	Part No.	Type
Mini	G1/8	185839	FRC-1/8-D-MINI-KF	185840	FRC-1/8-D-MINI-KF-A
	G1/4	185841	FRC-1/4-D-MINI-KF	185842	FRC-1/4-D-MINI-KF-A
Midi	G1/4	185843	FRC-1/4-D-MIDI-KF	185844	FRC-1/4-D-MIDI-KF-A
	G3/8	185845	FRC-3/8-D-MIDI-KF	185846	FRC-3/8-D-MIDI-KF-A
	G1/2	185847	FRC-1/2-D-MIDI-KF	185848	FRC-1/2-D-MIDI-KF-A
Maxi	G1/2	186061	FRC-1/2-D-MAXI-KF	186062	FRC-1/2-D-MAXI-KF-A
	G3/4	185849	FRC-3/4-D-MAXI-KF	185850	FRC-3/4-D-MAXI-KF-A
Directly actuated pressure regulator with integrated return flow function					
Maxi	G1/2	192472	FRC-1/2-D-DI-MAXI-KF	192482	FRC-1/2-D-DI-MAXI-KF-A
	G3/4	192477	FRC-3/4-D-DI-MAXI-KF	192487	FRC-3/4-D-DI-MAXI-KF-A

Note: This product conforms to ISO 1179-1 and to ISO 228-1

Service unit combinations FRC-K, D series

FESTO

Accessories

Ordering data – Angled socket PEV					Technical data → Internet: pev-1/4	
	Description	Operating voltage range	Electrical connection	Switching status display	Part No.	Type
	for PEV-1/4-...-OD	15 ... 30 V DC	4-pin	Yellow LED	164274	PEV-1/4-WD-LED-24
		≤ 230 V AC	4-pin	Yellow LED	164275	PEV-1/4-WD-LED-230
		≤ 180 V DC				

Ordering data – Plug socket MSSD					Technical data → Internet: mssd	
	Description	Operating voltage range	Electrical connection	Type of mounting cable connection	Part No.	Type
	for PEV-1/4-...-OD	≤ 250 V AC/DC	3-pin	Clamping screws	171157	MSSD-C-4P
	for on-off valve HEE	≤ 250 V AC/DC	3-pin	Clamping screws	151687	MSSD-EB
			4-pin	Insulation displacement technology	192745	MSSD-EB-S-M14

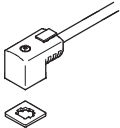
Ordering data – Plug socket with cable KMEB						Technical data → Internet: kmeb	
	Description	Operating voltage range	Electrical connection	Switching status display	Cable length [m]	Part No.	Type
	for on-off valve HEE	24 V DC	3-pin	LED	2.5	151688	KMEB-1-24-2,5-LED
					5	151689	KMEB-1-24-5-LED
					10	193457	KMEB-1-24-10-LED
		230 V AC	3-pin	–	2.5	151690	KMEB-1-230AC-2,5
					5	151691	KMEB-1-230AC-5

Ordering data – Illuminating seal MEB-LD				Technical data → Internet: meb	
	Description	Operating voltage range		Part No.	Type
	for plug socket with cable KMEB and plug socket MSSD-EB	12 ... 24 V DC		151717	MEB-LD-12-24DC
		230 V DC/AC ±10%		151718	MEB-LD-230AC