

Round cylinders EG

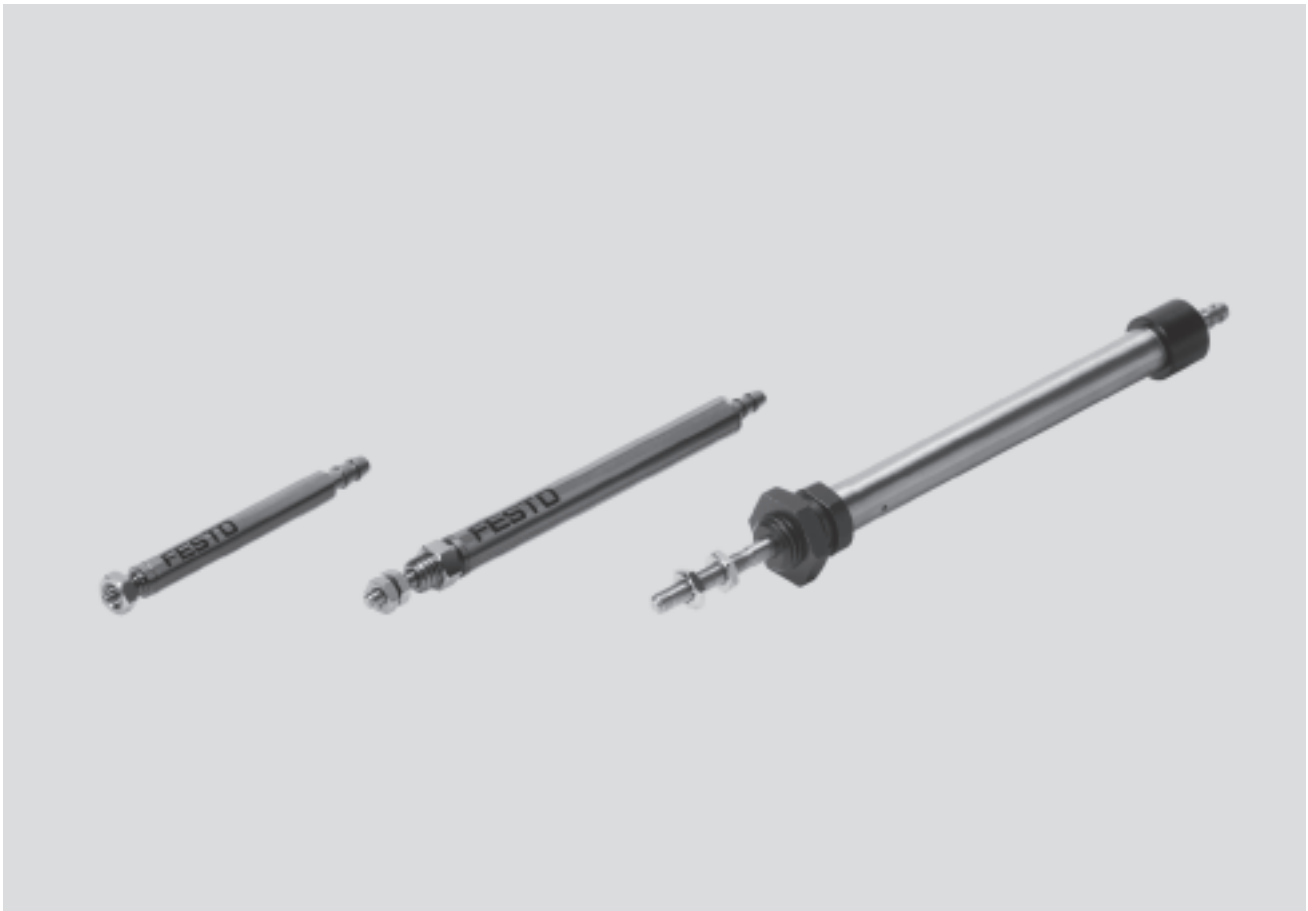

# Round cylinders EG

Key features and type code



## Pneumatic cylinders in miniature design

- The slim design makes these cylinders especially suitable for compact multiple assemblies, e.g. in keyboard testing systems.
- Single-acting
- Minimal weight: 2 to 20 g
- Ready for installation
- Resistant to corrosion
- Barbed fitting connection for plastic tubing with standard ID

		EG	2.5	5	PK2
<b>Type</b>					
Single-acting					
EG	Round cylinder				
<b>Piston area [mm]</b>					
<b>Stroke [mm]</b>					
<b>Pneumatic connection</b>					
PK-2	Barbed fitting for 2 mm plastic tubing				
PK-3	Barbed fitting for 3 mm plastic tubing				

# Round cylinders EG

Technical data

FESTO

Function

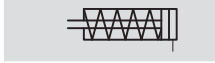

-  $\varnothing$  - Diameter  
2.5 ... 6 mm

- | - Stroke length  
5 ... 25 mm

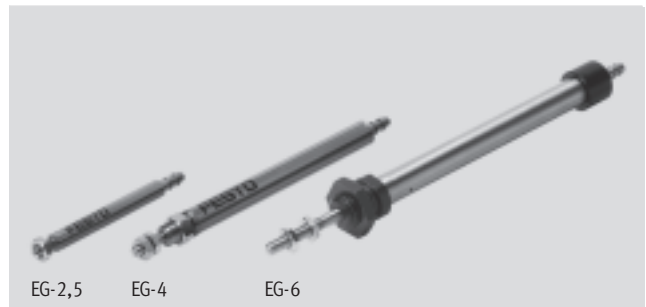

General technical data			
Piston $\varnothing$	2.5	4	6
Pneumatic connection	Barbed fitting for 2 mm plastic tubing		Barbed fitting for 3 mm plastic tubing
Piston rod thread	Plain rod $\varnothing$ 1	M2	M3
Operating medium	Filtered compressed air, lubricated or unlubricated		
Constructional design	Piston		
	Piston rod		
Cushioning	No		Non-adjustable at both ends
Position sensing	No		
Type of mounting	Via hex nut		
Mounting position	Any		

Operating and environmental conditions			
Piston $\varnothing$	2.5	4	6
Operating pressure [bar]	3.5 ... 7		
Temperature range [°C]	+5 ... +60		

Forces [N]												
Piston $\varnothing$	2.5			4				6				
Stroke	5	10		5	10	15	20	5	10	15	20	25
Theoretical force at 6 bar, advancing	1.7			6				14				
Spring return force	min.	0.6		1.5		1.8	1.5	4.2	3.1	2.0	3.1	2.6
	max.	1.2		2.9		2.6		5.3				

## Materials

Sectional view

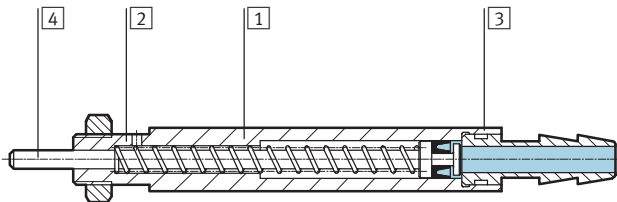

Piston $\varnothing$	2.5	4	6
1 Cylinder barrel	Nickel-plated brass		High-alloy steel
2 Bearing cap	Nickel-plated bronze		
3 End cap	-		Wrought aluminium alloy
4 Piston rod	High-alloy steel		
- Seals	Nitrile rubber		

# Round cylinders EG

Technical data

FESTO

## Dimensions and ordering data

Download CAD data → [www.festo.com](http://www.festo.com)

Piston Ø 2.5 mm

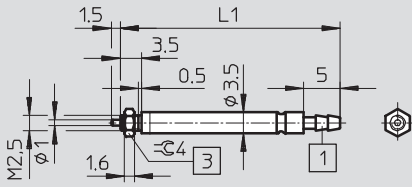

- 1 Barbed fitting for 2 mm plastic tubing with standard ID
- 2 Tightening torque 0,2 Nm
- 3 Tightening torque 0,2 Nm

Ø [mm]	Stroke [mm]	L1	Weight [g]	Part No.	Type
2.5	5	27.5	2	15 883	EG-2,5-5-PK-2
	10	36.5	3	15 884	EG-2,5-10-PK-2

Piston Ø 4 mm

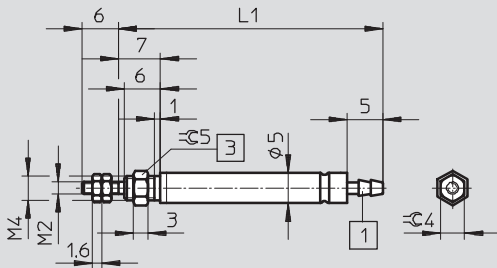

- 1 Barbed fitting for 2 mm plastic tubing with standard ID
- 2 Tightening torque 0,8 Nm
- 3 Tightening torque 0,8 Nm

Ø [mm]	Stroke [mm]	L1	Weight [g]	Part No.	Type
4	5	35	4	15 885	EG-4-5-PK-2
	10	44	5	15 886	EG-4-10-PK-2
	15	53	5	15 887	EG-4-15-PK-2
	20	58	6	15 888	EG-4-20-PK-2

Piston Ø 6 mm

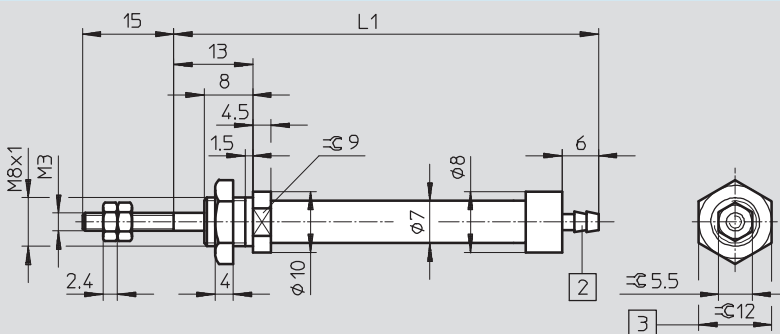

- 1 Barbed fitting for 3 mm plastic tubing with standard ID
- 2 Tightening torque 6 Nm
- 3 Tightening torque 6 Nm

Ø [mm]	Stroke [mm]	L1	Weight [g]	Part No.	Type
6	5	60	10	15 891	EG-6-5-PK-3
	10	65	12	15 892	EG-6-10-PK-3
	15	70	15	15 893	EG-6-15-PK-3
	20	87	18	15 894	EG-6-20-PK-3
	25	92	20	15 895	EG-6-25-PK-3