









- Easy to insert
- Easy to release
- Up to 6 outlets
- 360° rotatable

Multiple distributors QS, Quick Star

Key features



Application	Simply "plug and work"	Reliably connected	Captive seal
 <p>Effortless selection of the right fitting. Quick Star offers a secure solution for every connection. The convenient push-in fitting system includes well over 1000 types of standard and function fittings.</p>	 <p>The stainless steel retaining ring within the fitting holds the tubing securely without damaging its surface. Vibration and pressure surges are safely absorbed. The tubing can be detached easily by pressing down the blue release ring. For your convenience, the appropriate outside tubing diameter is marked on the release ring.</p>	 <p>A nitrile rubber sealing ring guarantees a perfect seal between standard OD tubing and the body of the fitting. Standard tubing is suitable for use with compressed air and vacuum.</p>	 <p>All of the brass components included in Festo's push-in fittings are nickel plated and are thus highly resistant to corrosion. The tapered ISO R threads have a self-sealing PTFE coating, which allows the fitting to be re-used up to five times without the need for additional sealing components.</p>

360° rotatable	360° rotatable, with ball bearing
 <p>Alignment is performed during assembly. Tube movement is compensated during use.</p>	 <p>Permits rotating motion of up to 500 rpm during use.</p>

Which fitting fits which thread?

Metric thread

- Cylindrical metric thread is comparable with G-thread
- Sealing is guaranteed by a clip-on O-ring

G thread

to DIN ISO 228-1

- Shorter thread
- Constant installation depth
- Replaceable sealing ring
- Sealing at front
- Can be re-used a number of times thanks to replaceable sealing ring

R thread

to DIN 2999-1 und ISO 7/1

- Self-sealing thread
- Sealing on the threads
- No additional sealing surface required
- Smaller installation dimensions since there is no need for a rebate for the sealing surface
- Can be re-used up to five times

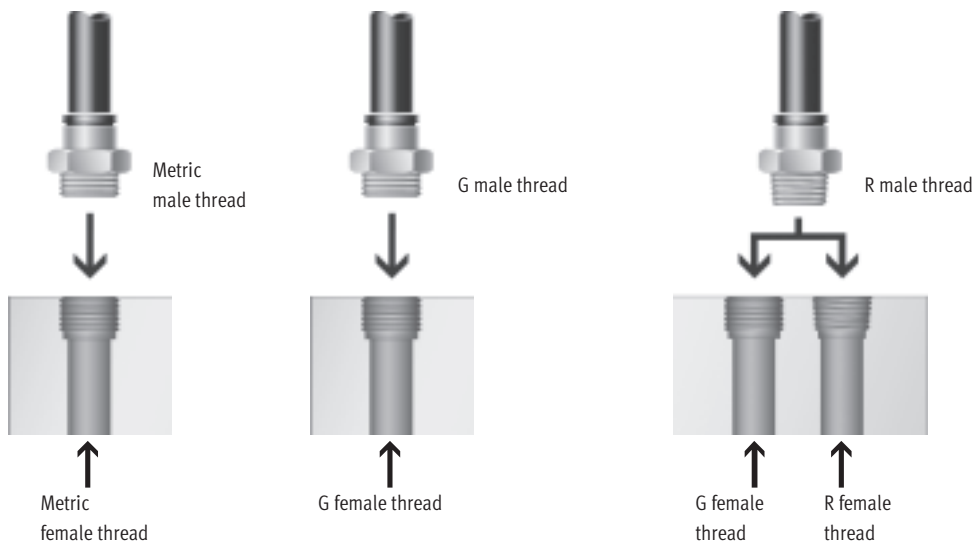

Multiple distributors QS, Quick Star

Technical data

FESTO

Materials

Sectional view

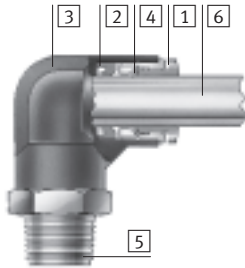

	Standard QS
1 Release ring	Polyacetate
2 Seal	Nitrile rubber
3 Housing	Polybuteneterephthalate Nickel plated brass
4 Tube clamping segment	High alloy stainless steel
5 Threaded coupling	Nickel plated brass PTFE sealing compound
6 Plastic tubing, standard O.D.	PAN PUN PUN-H PUN-E
Note on materials	RoHS-conform

Tubing insertion depth



Tubing O.D. [mm]	4	6	8	10	12
Standard QS	15	17	18	20.5	23.5

Operating and environmental conditions

	Standard QS
Temperature dependent operating pressure [bar]	-0.95 ... +14
Operating temperature [°C]	-10 ... +80
Corrosion resistance CRC ¹⁾	1
Certification	Germanischer Lloyd

- 1) Corrosion resistance class 1 according to Festo standard 940 070
Components requiring low corrosion resistance. Transport and storage protection. Parts that do not have primarily decorative surface requirements, e.g. in internal areas that are not visible or behind covers.

Operating pressure p as a function of temperature t

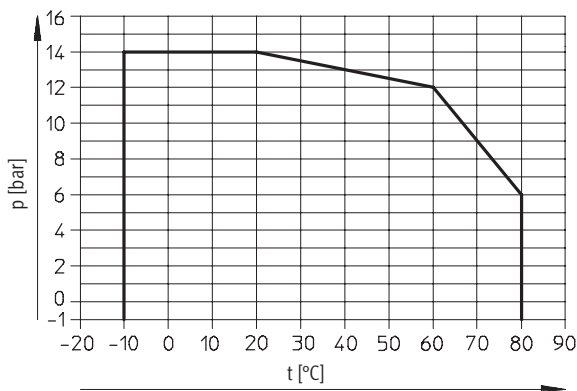

Multiple distributors QS, Quick Star

Technical data

FESTO

Possible push-in fitting/tubing combinations					
Thread	Tubing O.D. [mm]				
	4	6	8	10	12
R1/8	+	++	+	+	-
R1/4	+	+	++	+	+
R3/8	-	+	+	++	+
R1/2	-	-	-	+	++
G1/8	+	++	+	-	-
G1/4	-	+	++	+	+
G3/8	-	-	+	++	+
G1/2	-	-	-	-	++









+ Possible thread/tubing O.D. combinations

++ Optimum thread/tubing O.D. combinations (with regard to flow)

Multiple distributors QS, Quick Star

Product range overview

FESTO

Shape	Design	Type	Connection D1			Connection D2	Connection D3	→ Page/ Internet
			R thread	G thread	Tubing O.D.	Tubing O.D.	Tubing O.D.	
L-shape	Multiple distributor, rotatable 360° – 2 outlets							
		QSLV2	R 1/8	G 1/8	-	4, 6, 8	-	6
			R 1/4	G 1/4		6, 8, 10		
			R 3/8	G 3/8		8, 10, 12		
			R 1/2	G 1/2		12		
	Multiple distributor, rotatable 360° – 3 outlets							
		QSLV3	R 1/8	G 1/8	-	4, 6, 8	-	7
			R 1/4	G 1/4		6, 8, 10		
			R 3/8	G 3/8		8, 10, 12		
			R 1/2	G 1/2		12		
	Multiple distributor, rotatable 360° – 4 outlets							
		QSLV4	R 1/8	G 1/8	-	4, 6, 8	-	8
			R 1/4	G 1/4		6, 8, 10		
			R 3/8	G 3/8		8, 10, 12		
			R 1/2	G 1/2		12		
Multiple distributor, rotatable 360° – 6 outlets								
	QSLV6	R 1/8	G 1/8	-	4, 6, 8	-	9	
		R 1/4	G 1/4		6, 8, 10			
		R 3/8	G 3/8		8, 10, 12			
		R 1/2	G 1/2		12			
Multiple distributor, rotatable 360° – 4 outlets								
	QSQ	R 1/8	G 1/8	-	4, 6	-	10	
		R 1/4	G 1/4		4, 6			
	QSQ reducing	-	-	6	4	-	10	
		-	-	8	6			
T-shape	Multiple distributor, rotatable 360° – 3 outlets							
		QST3	R 1/8	G 1/8	-	6	4	11
			R 1/4	G 1/4		8	6	
			R 3/8	G 3/8		10	8	
		QST3 reducing	-	-	6	6	4	11
			-	-	8	8	6	
-			-	10	10	8		

Multiple distributors QSLV2, Quick Star

Technical data

FESTO

Multiple distributor QSLV2

2 outlets

360° rotatable



R thread

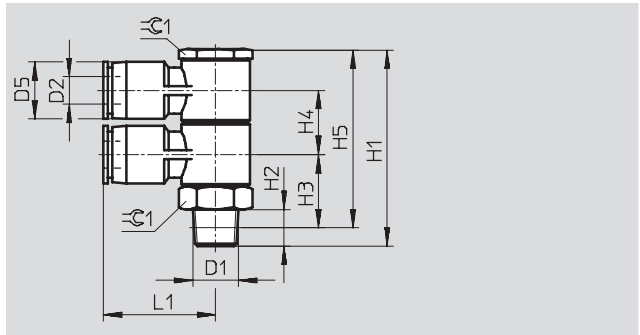

G thread

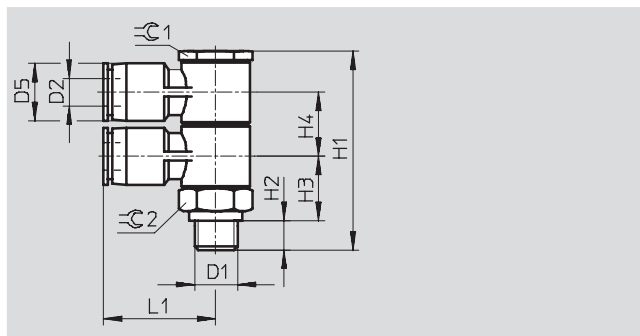

Dimensions and ordering data															
Connection	Nominal size [mm]	Tubing O.D. D2	D5 ∅	H1	H2	H3	H4	H5	L1	⊖C1	⊖C2	Weight/ piece [g]	Part No.	Type	PU*
R thread															
R $\frac{1}{8}$	2.5	4	10	43.3	8	16.1	14	39	22.2	14	-	29	153 211	QSLV2- $\frac{1}{8}$ -4	1
	3.4	6	12.5	43.3	8	16.1	14	39	24.2	14	-	31	153 212	QSLV2- $\frac{1}{8}$ -6	1
	4.3	8	14.5	46.3	8	17.6	15	42	28.2	17	-	48	153 214	QSLV2- $\frac{1}{8}$ -8	1
R $\frac{1}{4}$	3.4	6	12.5	46.3	11	17.1	14	40	24.2	14	-	33	153 213	QSLV2- $\frac{1}{4}$ -6	1
	4.4	8	14.5	49.3	11	18.5	15	43	28.2	17	-	51	153 215	QSLV2- $\frac{1}{4}$ -8	1
	5.2	10	18	57.8	11	22	18	51.5	32.5	22	-	89	153 217	QSLV2- $\frac{1}{4}$ -10	1
R $\frac{3}{8}$	4.4	8	14.5	50.3	12	19.2	15	43.5	28.2	17	-	56	153 216	QSLV2- $\frac{3}{8}$ -8	1
	5.4	10	18	58.8	12	22.7	18	52	32.5	22	-	95	153 218	QSLV2- $\frac{3}{8}$ -10	1
	6.3	12	21	68.4	12	27.3	21	62.1	38.2	27	-	152	153 219	QSLV2- $\frac{3}{8}$ -12	1
R $\frac{1}{2}$	6.3	12	21	71.4	15	28.4	21	63	38.2	27	-	159	153 220	QSLV2- $\frac{1}{2}$ -12	1
G thread with sealing ring															
G $\frac{1}{8}$	2.5	4	10	42.2	5.1	13.9	14	-	22.2	14	14	29	186 223	QSLV2-G $\frac{1}{8}$ -4	1
	3.4	6	12.5	42.2	5.1	13.9	14	-	24.2	14	14	31	186 224	QSLV2-G $\frac{1}{8}$ -6	1
	4.3	8	14.5	45.2	5.1	15.4	15	-	28.2	17	17	47	186 226	QSLV2-G $\frac{1}{8}$ -8	1
G $\frac{1}{4}$	3.4	6	12.5	43.7	5.6	14.4	14	-	24.2	14	17	39	186 225	QSLV2-G $\frac{1}{4}$ -6	1
	4.4	8	14.5	45.7	5.6	15.4	15	-	28.2	17	17	49	186 227	QSLV2-G $\frac{1}{4}$ -8	1
	5.2	10	18	54.2	5.6	18.9	18	-	32.5	22	22	88	186 229	QSLV2-G $\frac{1}{4}$ -10	1
G $\frac{3}{8}$	4.4	8	14.5	47.2	6.6	15.9	15	-	28.2	17	19	88	186 228	QSLV2-G $\frac{3}{8}$ -8	1
	5.4	10	18	55.7	6.6	19.4	18	-	32.5	22	22	91	186 230	QSLV2-G $\frac{3}{8}$ -10	1
	6.3	12	21	65.3	6.6	23.9	21	-	38.2	27	27	118	186 231	QSLV2-G $\frac{3}{8}$ -12	1
G $\frac{1}{2}$	6.3	12	21	66.3	7.6	23.9	21	-	38.2	27	27	152	186 232	QSLV2-G $\frac{1}{2}$ -12	1

* Packaging unit quantity

Multiple distributors QSLV3, Quick Star

Technical data

Multiple distributor QSLV3

3 outlets

360° rotatable



R thread

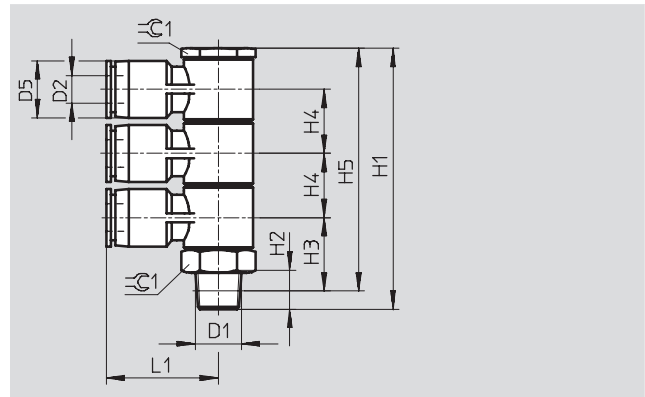

G thread

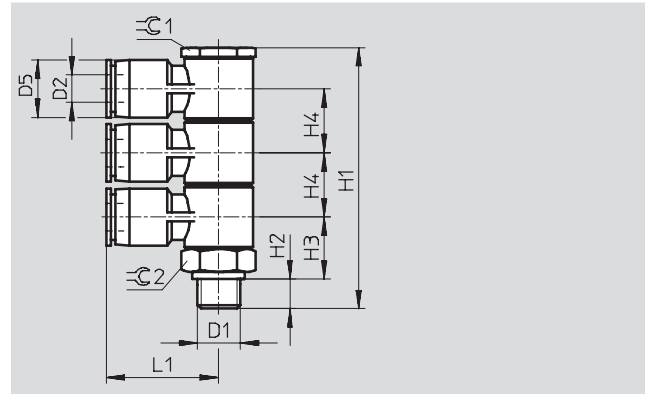

Dimensions and ordering data															
Connection	Nominal size [mm]	Tubing O.D. D2	D5 Ø	H1	H2	H3	H4	H5	L1	⌀C1	⌀C2	Weight/ piece [g]	Part No.	Type	PU*
R thread															
R $\frac{1}{8}$	2.4	4	10	57.4	8	16.1	14	53.4	22.2	14	-	38	153 221	QSLV3- $\frac{1}{8}$ -4	1
	3.5	6	12.5	57.4	8	16.1	14	53.4	24.2	14	-	41	153 222	QSLV3- $\frac{1}{8}$ -6	1
	4.3	8	14.5	61.3	8	17.6	15	57.3	28.2	17	-	63	153 224	QSLV3- $\frac{1}{8}$ -8	1
R $\frac{1}{4}$	3.5	6	12.5	60.4	11	17.1	14	54.4	24.2	14	-	44	153 223	QSLV3- $\frac{1}{4}$ -6	1
	4.4	8	14.5	64.3	11	18.5	15	58.3	28.2	17	-	66	153 225	QSLV3- $\frac{1}{4}$ -8	1
	5.3	10	18	75.8	11	22	18	69.8	32.5	22	-	114	153 227	QSLV3- $\frac{1}{4}$ -10	1
R $\frac{3}{8}$	4.4	8	14.5	65.3	12	19.2	15	59	28.2	17	-	70	153 226	QSLV3- $\frac{3}{8}$ -8	1
	5.4	10	18	76.8	15	22.7	18	70.5	32.5	22	-	120	153 228	QSLV3- $\frac{3}{8}$ -10	1
	6.2	12	21	89.5	12	27.3	21	83.2	38.2	27	-	188	153 229	QSLV3- $\frac{3}{8}$ -12	1
R $\frac{1}{2}$	6.3	12	21	92.5	15	28.4	21	84.3	38.2	27	-	196	153 230	QSLV3- $\frac{1}{2}$ -12	1
G thread with sealing ring															
G $\frac{1}{8}$	2.4	4	10	56.2	5.1	13.9	14	-	22.2	14	14	38	186 233	QSLV3-G $\frac{1}{8}$ -4	1
	3.5	6	12.5	56.2	5.1	13.9	14	-	24.2	14	14	40	186 234	QSLV3-G $\frac{1}{8}$ -6	1
	4.3	8	14.5	59.2	5.1	15.4	15	-	28.2	17	17	62	186 236	QSLV3-G $\frac{1}{8}$ -8	1
G $\frac{1}{4}$	3.5	6	12.5	57.7	5.6	14.4	14	-	24.2	14	17	49	186 235	QSLV3-G $\frac{1}{4}$ -6	1
	4.4	8	14.5	59.7	5.6	15.4	15	-	28.2	17	17	63	186 237	QSLV3-G $\frac{1}{4}$ -8	1
	5.3	10	18	68.2	5.6	18.9	18	-	32.5	22	22	112	186 239	QSLV3-G $\frac{1}{4}$ -10	1
G $\frac{3}{8}$	4.4	8	14.5	61.2	6.6	15.9	15	-	28.2	17	19	102	186 238	QSLV3-G $\frac{3}{8}$ -8	1
	5.4	10	18	69.7	6.6	19.4	18	-	32.5	22	22	117	186 240	QSLV3-G $\frac{3}{8}$ -10	1
	6.2	12	21	79.3	6.6	23.9	21	-	38.2	27	27	154	186 241	QSLV3-G $\frac{3}{8}$ -12	1
G $\frac{1}{2}$	6.3	12	21	80.3	7.6	23.9	21	-	38.2	27	27	188	186 242	QSLV3-G $\frac{1}{2}$ -12	1

* Packaging unit quantity

Multiple distributors QSLV4, Quick Star

FESTO

Technical data

Multiple distributor QSLV4

4 outlets

360° rotatable



R thread

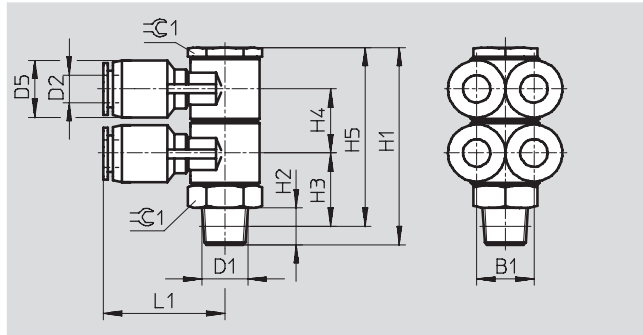

G thread

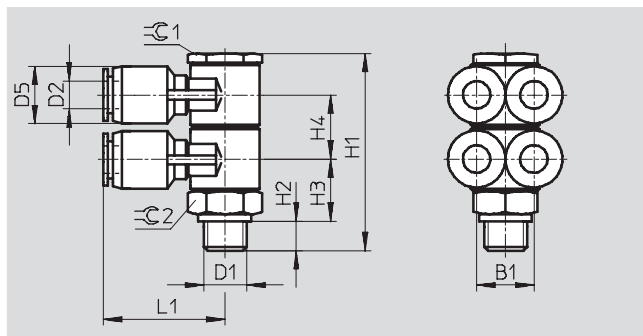

Dimensions and ordering data																
Connection	Nom- inal size [mm]	Tubing O.D. D2	D5 ∅	H1	H2	H3	H4	H5	L1	B1	⌀C1	⌀C2	Weight/ piece [g]	Part No.	Type	PU*
R thread																
R $\frac{1}{8}$	2.3	4	10	43.3	8	16.1	14	39.3	22.2	10	14	-	34	153 231	QSLV4- $\frac{1}{8}$ -4	1
	3	6	12.4	43.3	8	16.1	14	39.3	26.2	12	14	-	38	153 232	QSLV4- $\frac{1}{8}$ -6	1
	4	8	14.4	46.3	8	17.6	15	42.3	29.1	14	17	-	57	153 234	QSLV4- $\frac{1}{8}$ -8	1
R $\frac{1}{4}$	3	6	12.4	46.3	11	17.1	14	42	26.2	12	14	-	40	153 233	QSLV4- $\frac{1}{4}$ -6	1
	4.2	8	14.4	49.3	11	18.5	15	43.3	29.1	14	17	-	60	153 235	QSLV4- $\frac{1}{4}$ -8	1
	5.2	10	17.6	57.8	12	22	18	51.8	33.5	17	22	-	102	153 237	QSLV4- $\frac{1}{4}$ -10	1
R $\frac{3}{8}$	4.2	8	14.6	50.3	12	19.2	15	44	29.1	14	17	-	65	153 236	QSLV4- $\frac{3}{8}$ -8	1
	5.2	10	17.6	58.5	12	22.7	18	52.5	33.5	17	22	-	109	153 238	QSLV4- $\frac{3}{8}$ -10	1
	7.5	12	21	68.4	12	27.3	21	62.1	37.4	20	27	-	168	153 239	QSLV4- $\frac{3}{8}$ -12	1
R $\frac{1}{2}$	7.6	12	21	71.4	15	28.4	21	63.2	37.4	20	27	-	176	153 240	QSLV4- $\frac{1}{2}$ -12	1
G thread with sealing ring																
G $\frac{1}{8}$	2.3	4	10	42.2	5.1	13.9	14	-	22.2	10	14	14	34	186 243	QSLV4-G $\frac{1}{8}$ -4	1
	3	6	12.4	42.2	5.1	13.9	14	-	26.2	12	14	14	38	186 244	QSLV4-G $\frac{1}{8}$ -6	1
	4	8	14.4	45.2	5.1	15.4	15	-	29.1	14	17	17	56	186 246	QSLV4-G $\frac{1}{8}$ -8	1
G $\frac{1}{4}$	3	6	12.4	43.7	5.6	14.4	14	-	26.2	12	14	17	46	186 245	QSLV4-G $\frac{1}{4}$ -6	1
	4.2	8	14.4	45.7	5.6	15.4	15	-	29.1	14	17	17	58	186 247	QSLV4-G $\frac{1}{4}$ -8	1
	5.2	10	17.6	54.2	5.6	18.9	18	-	33.5	17	22	22	101	186 249	QSLV4-G $\frac{1}{4}$ -10	1
G $\frac{3}{8}$	4.2	8	14.4	47.2	6.6	15.9	15	-	29.1	14	17	19	97	186 248	QSLV4-G $\frac{3}{8}$ -8	1
	5.2	10	17.6	55.7	6.6	19.4	18	-	33.5	17	22	22	106	186 250	QSLV4-G $\frac{3}{8}$ -10	1
	7.5	12	21	65.3	6.6	23.9	21	-	37.4	20	27	27	135	186 251	QSLV4-G $\frac{3}{8}$ -12	1
G $\frac{1}{2}$	7.6	12	21	66.3	7.6	23.9	21	-	37.4	20	27	27	169	186 252	QSLV4-G $\frac{1}{2}$ -12	1

* Packaging unit quantity

Multiple distributors QSLV6, Quick Star

Technical data

Multiple distributor QSLV6

6 outlets

360° rotatable

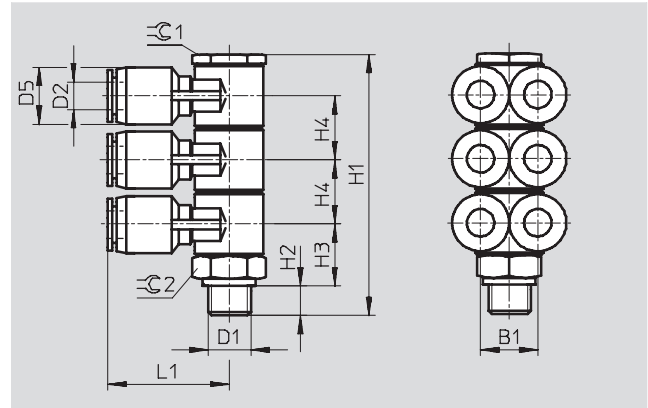
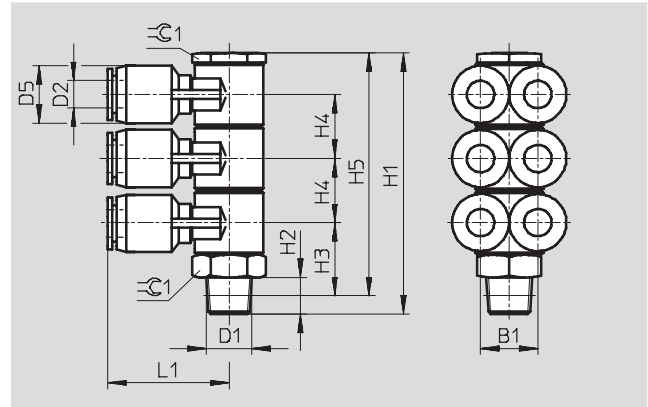

Dimensions and ordering data																
Connection	Nominal size	Tubing O.D.	D5	H1	H2	H3	H4	H5	L1	B1	≈C1	≈C2	Weight/ piece	Part No.	Type	PU*
D1	[mm]	D2	∅										[g]			
R thread																
R ¹ / ₈	2.5	4	10	57.4	8	16.1	14	53.4	22.2	10	14	-	45	153 241	QSLV6-1/8-4	1
	2.9	6	12.4	57.4	8	16.1	14	53.4	26.2	12	14	-	51	153 242	QSLV6-1/8-6	1
	4.1	8	14.4	61.3	8	17.6	15	57.3	29.1	14	17	-	76	153 244	QSLV6-1/8-8	1
R ¹ / ₄	2.9	6	12.4	60.4	11	17.1	14	54.4	26.2	12	14	-	54	153 243	QSLV6-1/4-6	1
	4.1	8	14.4	64.3	11	18.5	15	58.3	29.1	14	17	-	79	153 245	QSLV6-1/4-8	1
	5.2	10	17.6	75.8	12	22	18	69.8	33.5	17	22	-	134	153 247	QSLV6-1/4-10	1
R ³ / ₈	4.2	8	14.4	65.3	12	19.2	15	59	29.1	14	17	-	84	153 246	QSLV6-3/8-8	1
	5.2	10	17.6	76.8	15	22.7	18	70.5	33.5	17	22	-	140	153 248	QSLV6-3/8-10	1
	7.6	12	21	89.5	12	27.3	21	83.2	37.4	20	27	-	214	153 249	QSLV6-3/8-12	1
R ¹ / ₂	7.6	12	21	92.5	15	28.4	21	84.3	37.4	20	27	-	221	153 250	QSLV6-1/2-12	1
G thread with sealing ring																
G ¹ / ₈	2.5	4	10	56.2	5.1	13.9	14	-	22.2	10	14	14	45	186 253	QSLV6-G1/8-4	1
	2.9	6	12.4	56.2	5.1	13.9	14	-	26.2	12	14	14	50	186 254	QSLV6-G1/8-6	1
	4.1	8	14.4	59.2	5.1	15.4	15	-	29.1	14	17	17	75	186 256	QSLV6-G1/8-8	1
G ¹ / ₄	2.9	6	12.4	57.7	5.6	14.4	14	-	26.2	12	14	17	59	186 255	QSLV6-G1/4-6	1
	4.1	8	14.4	59.7	5.6	15.4	15	-	29.1	14	17	17	77	186 257	QSLV6-G1/4-8	1
	5.2	10	17.6	68.2	5.6	18.9	18	-	33.5	17	22	22	133	186 259	QSLV6-G1/4-10	1
G ³ / ₈	4.2	8	14.4	61.2	6.6	15.9	15	-	29.1	14	17	19	116	186 258	QSLV6-G3/8-8	1
	5.2	10	17.6	69.7	6.6	19.4	18	-	33.5	17	22	22	137	186 260	QSLV6-G3/8-10	1
	7.6	12	21	79.3	6.6	23.9	21	-	37.4	20	27	27	179	186 261	QSLV6-G3/8-12	1
G ¹ / ₂	7.6	12	21	80.3	7.6	23.9	21	-	37.4	20	27	27	213	186 262	QSLV6-G1/2-12	1

* Packaging unit quantity

Multiple distributors QSQ, Quick Star

Technical data



Multiple distributor QSQ

360° rotatable
Male thread
with external hex
4 outlets



R thread

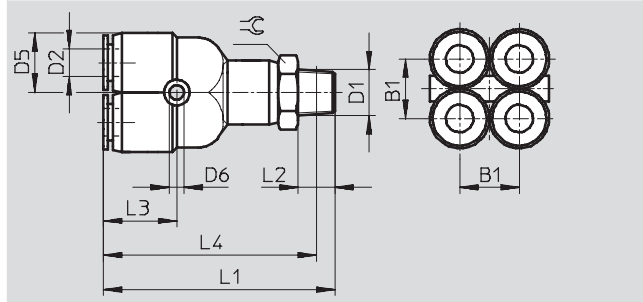

G thread

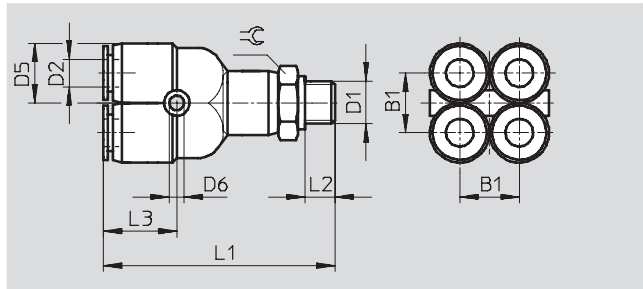

Push-in connector QSQ

360° rotatable
4 outlets
reducing



Reducing

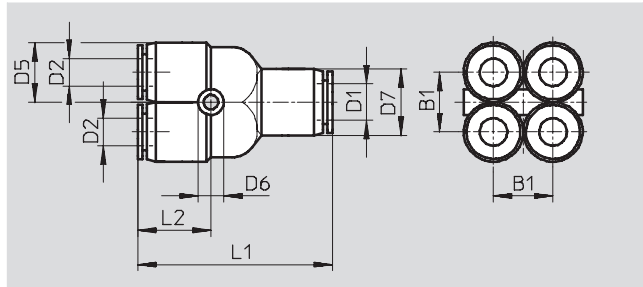

Dimensions and ordering data															
Connection	Nominal size [mm]	Tubing O.D. D2	B1	D5 ∅	D6 ∅	D7 ∅	L1	L2	L3	L4	∅	Weight/ piece [g]	Part No.	Type	PU*
R thread															
R $\frac{1}{8}$	2	4	10	10.5	3.2	–	46	8	14	42	12	21.5	153 206	QSQ- $\frac{1}{8}$ -4	1
	2.1	6	13	13	3.2	–	50.5	8	16	56.5	12	29	153 208	QSQ- $\frac{1}{8}$ -6	1
R $\frac{1}{4}$	2	4	10	10.5	3.2	–	49	11	14	43	14	29.5	153 207	QSQ- $\frac{1}{4}$ -4	1
	2.1	6	13	13	3.2	–	53.5	11	16	48	16	–	153 288	QSQ- $\frac{1}{4}$ -6	1
G thread with sealing ring															
G $\frac{1}{8}$	1.4	4	10	10.5	3.2	–	44.7	5.1	14.2	–	13	22	186 220	QSQ-G $\frac{1}{8}$ -4	1
	3.4	6	13	13	3.5	–	49.3	5.1	15.8	–	14	28	186 222	QSQ-G $\frac{1}{8}$ -6	1
G $\frac{1}{4}$	1.3	4	10	10.5	3.2	–	46.2	5.6	14.2	–	17	31	186 221	QSQ-G $\frac{1}{4}$ -4	1
	3	6	13	13	3.5	–	50.8	5.6	15.8	–	17	37	186 263	QSQ-G $\frac{1}{4}$ -6	1
Reducing															
6	1.4	4	10	10.5	3.2	13	37.5	14	–	–	–	14	153 209	QSQ-6-4	1
8	3.2	6	13	13	3.2	14.5	42.5	16	–	–	–	20.5	153 210	QSQ-8-6	1

* Packaging unit quantity

Multiple distributors QST3, Quick Star

Technical data

Multiple distributor QST3

360° rotatable
Male thread
with external hex
3 outlets



R thread

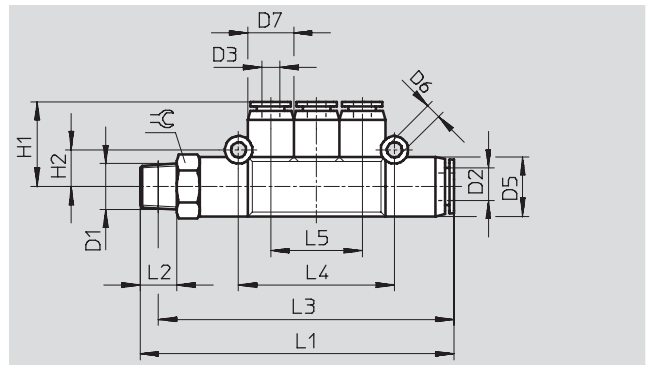

G thread

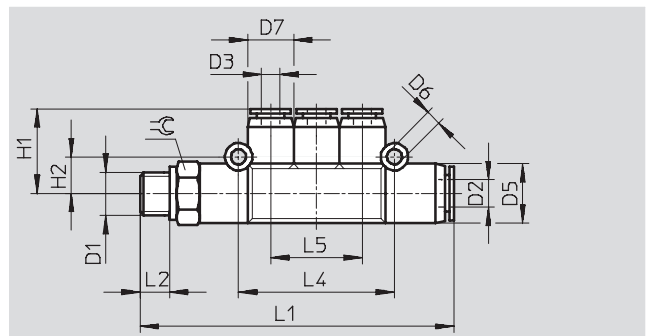

Push-in multiple distributor QST3

360° rotatable
reducing



Reducing

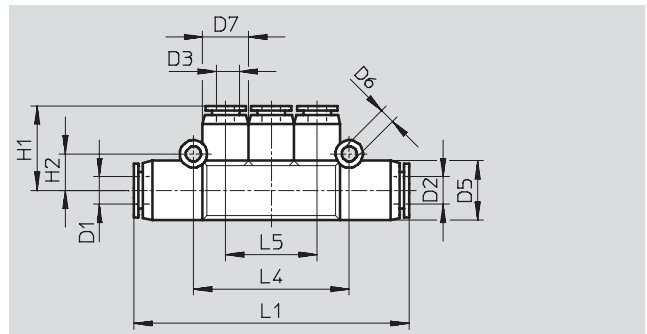

Dimensions and ordering data																		
Connec- tion	Nom- inal size [mm]	Tubing O.D.		D5 ∅	D6 ∅	D7 ∅	H1	H2	L1	L2	L3	L4	L5	≈C	Weight [g]	Part No.	Type	PU*
D1		D2	D3															
R thread																		
R $\frac{1}{8}$	2.5	6	4	13	3.3	10	18.5	8	68.5	8	64.5	34	20	12	23	153 200	QST3- $\frac{1}{8}$ -6-4	1
R $\frac{1}{4}$	3.5	8	6	15	3.3	13	20	9	81	11	75	40	24	14	36.5	153 201	QST3- $\frac{1}{4}$ -8-6	1
R $\frac{3}{8}$	4.9	10	8	18	3.3	15	24	10.5	93.5	12	87	46	28	17	39.5	153 202	QST3- $\frac{3}{8}$ -10-8	1
G thread with sealing ring																		
G $\frac{1}{8}$	2.5	6	4	13	3.3	10	18.4	8	67.4	5.1	-	34	20	13	24	186 217	QST3-G $\frac{1}{8}$ -6-4	1
G $\frac{1}{4}$	3.5	8	6	15	3.3	13	21.3	9	78.2	5.6	-	40.2	24	17	39	186 218	QST3-G $\frac{1}{4}$ -8-6	1
G $\frac{3}{8}$	4.9	10	8	17.5	3.3	15	23.7	10.5	90	6.6	-	46.2	28	19	59	186 219	QST3-G $\frac{3}{8}$ -10-8	1
Reducing																		
6	2.5	6	4	13	3.3	10	18.5	8	60	-	-	34	20	-	16	153 203	QST3-6-4	1
8	3.6	8	6	15	3.3	13	21	9	69.5	-	-	40	24	-	23	153 204	QST3-8-6	1
10	4.9	10	8	18	3.3	15	23.5	10.5	80	-	-	46	28	-	33	153 205	QST3-10-8	1

* Packaging unit quantity