

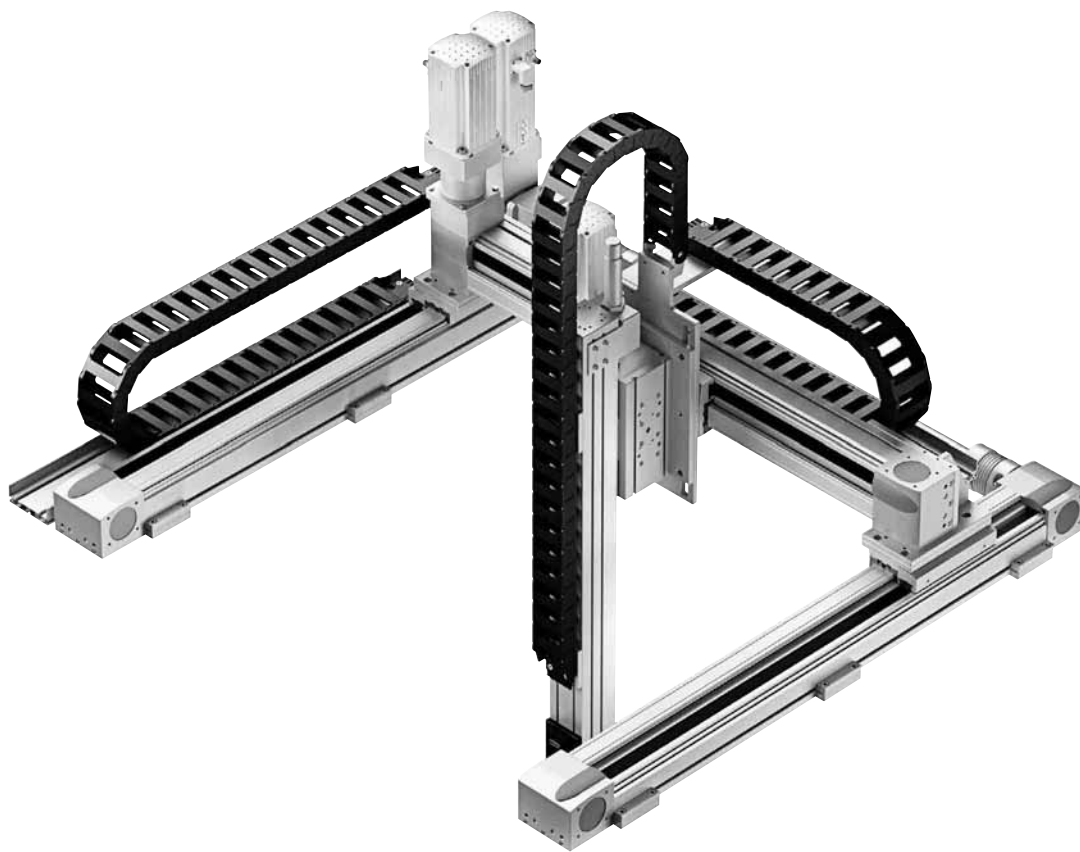

Three-dimensional gantries



A three-dimensional gantry consists of horizontal gantry axes and a vertical drive.

- Can be used universally for handling light to heavy workpieces or high effective loads
- Ideal for very long strokes
- High mechanical rigidity and sturdy design
- Pneumatic and electrical components – freely combinable
- As electrical solution – variable positioning/any desired intermediate positions

Range of application:

- For any movement in 3D space
- Very high requirements on precision and/or very heavy workpieces, with long strokes at the same time

Planar surface gantry

The planar surface gantry is equivalent to a three-dimensional gantry, but without a Z-axis and allows free movement in the plane.

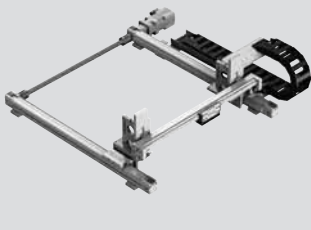

Example: automotive industry

Load handling in assembly system for solenoids







Requirements

- Flexible positioning
- High speed and long horizontal strokes
- Fast system availability
- Complete documentation of process values

Solution

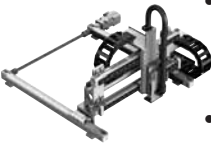
Three-dimensional gantry with toothed belt axes DGE from the multi-axis modular system



Type	Important characteristics	Axis design	Effective load	Max. effective strokes	Components
 <ul style="list-style-type: none"> • Three-dimensional gantry as mono axis • Free movement of Z-axis in the available space (3D) 	<ul style="list-style-type: none"> • Compact design • High process reliability thanks to installation integration • Pneumatic and electric drives • Repetition-accurate, centralised direct axis connections • Pneumatic and electric drives (with freely programmable positions in X and Y) • Very high dynamic response and precision 	X: Gantry axes Y: Gantry axes Z: Slides Cantilever axis	Mono: 0 to 6 kg	X: Up to 8500 mm Y: Up to 1500 mm Z: Up to 300 mm	X: DGE/ EGC Y: DGE/ EGC DGC/DGPL Z: DGSL EGSA
 <ul style="list-style-type: none"> • See above 	<ul style="list-style-type: none"> • See above, points 1–5 • Z-axis with optional intermediate position (can be passed through) and clamping unit 	X: Gantry axes Y: Gantry axes Z: Cantilever axis	Mono: 0 to 5 kg	X: Up to 8500 mm Y: Up to 1500 mm Z: Up to 200 mm	X: DGE/ EGC Y: DGE/ EGC DGC/DGPL Z: HMPL
 <ul style="list-style-type: none"> • See above 	<ul style="list-style-type: none"> • See above, points 1–5 • Z-axis with optional intermediate position and clamping unit 	X: Gantry axes Y: Gantry axes Z: Cantilever axis	Mono: 0 to 10 kg*	X: Up to 8500 mm Y: Up to 2000 mm Z: Up to 400 mm	X: DGE/ EGC Y: DGE/ EGC DGC/DGPL Z: HMP
 <ul style="list-style-type: none"> • Three-dimensional gantry as mono or duo axis • Free movement of Z-axis in the available space (3D) 	<ul style="list-style-type: none"> • See above, points 1–5 • Z-axis alternative guides and drive concepts (motors) 	X: Gantry axes Y: Gantry axes Z: Cantilever axis	Mono: 0 to 15 kg Duo: 0 to 25 kg	X: Up to 8500 mm Y: Up to 2000 mm Z: Up to 900 mm	X: DGE/ EGC Y: DGE/ EGC DGC/DGPL Z: DGEA

- System solution for standardised three-dimensional gantries with effective load up to 50 kg on request
- Long strokes in X direction up to 10 m on request

* With the pneumatic drive DGC, can be used as duo axis

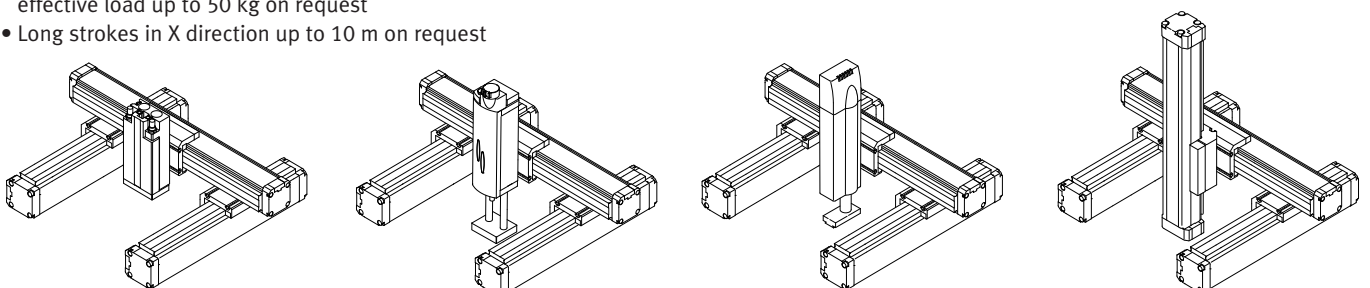

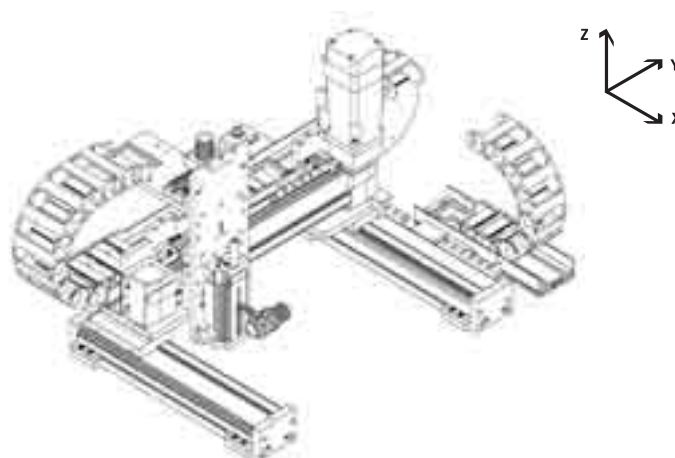

Standard 3D gantry RP 2

Effective load up to 2 kg



Technical data

		Stroke/mm	Intermed. position	Repetition accuracy/mm	
Z-axis 				End position	Intermediate position
ZR	DGEA-18	0 ... 400	Any	± 0.05	± 0.05
SP	EGSA-50	0 ... 100	Any	± 0.01	± 0.01
ES	EGSL-45	0 ... 100	Any	± 0.015	± 0.015
P	DGSL-10	0 ... 200	–	± 0.01****	–
P	DFM-16	0 ... 200	–	–	–
Y-axis 					
ZR	1 x EGC-80-TB-KF	0 ... 1500	Any	± 0.08	± 0.08
SP	1 x EGC-80-BS-KF	0 ... 1500	Any	± 0.02	± 0.02
P	DGC-25-KF	0 ... 1500	1*	± 0.02***	± 0.02/± 0.1
PS	DGCI-25-KF	0 ... 1500	2/any**	± 0.02/± 0.3	± 1/± 0.3
X-axis 					
ZR	EGC-80-TB-KF	0 ... 8500	Any	± 0.08	± 0.08

* More than 1 on request

** 2 with SPC11/CMPX, any with SPC200/CMAX

*** With cushioning P1/Y3

**** With shock absorber YSR/YSRW

Grey shading: drive components in the illustration

EGC-HD: available end of 2011

Reference for cycle times

Z-axis

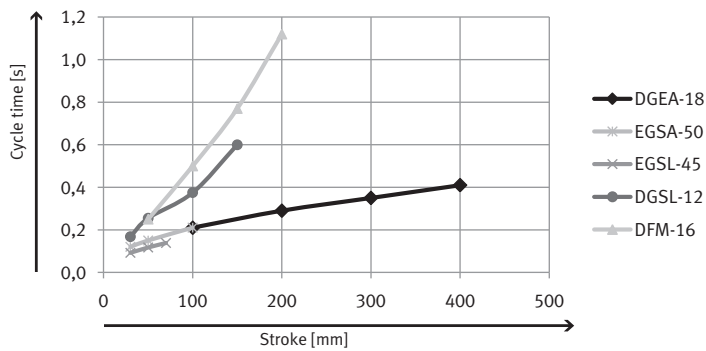

Y-axis

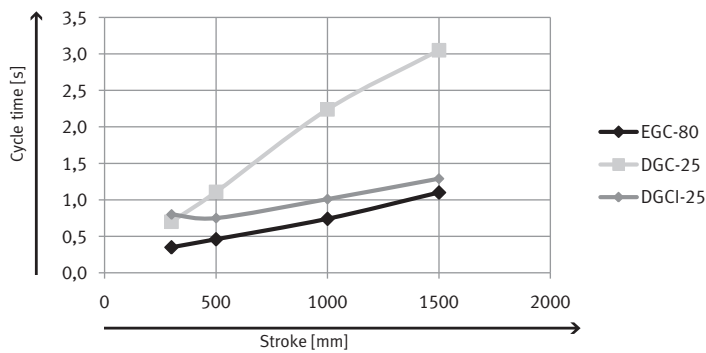

X-axis

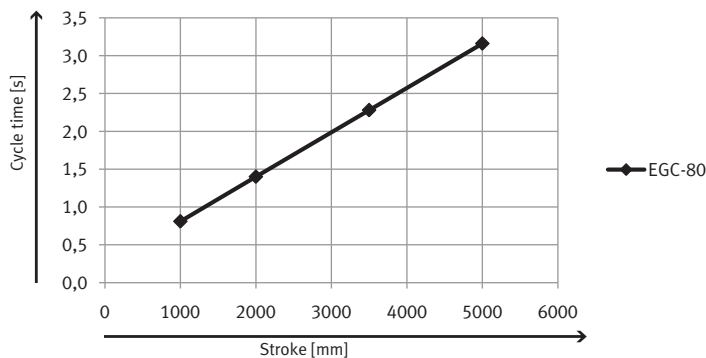

Note

Selection matrix

Types of handling units

→ Pages 6 to 9

Handling components

→ Page 95

Gripping/rotating

Adaptation options

→ Page 71

Control cabinets

→ Page 92

Frames

→ Page 78

CAD drawings/

CAD hotline

2D and 3D drawings

→

Tel. +49 (0)711 347-4667

Individual project engineering and cycle time calculation

→

Tel. +49 (0)711 347-4381

Fax enquiry

Form

→ Page 101

Note

An operating pressure of 6 bar is assumed for all the pneumatic drives shown here.

Overview of Festo control products

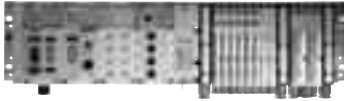
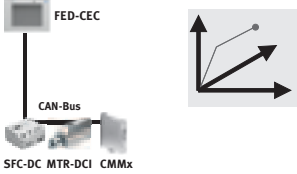
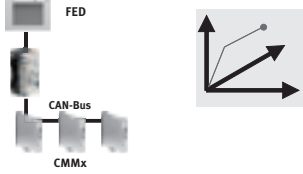
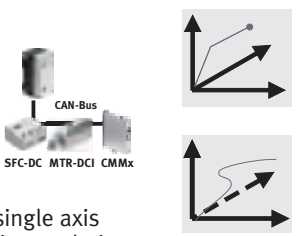
	 FED-CEC	 CPX terminal	
	Integrated controller FED-CEC	CoDeSys controller CPX-CEC-C1	Motion controller CPX-CEC-M1
	 Single axis (point-to-point asynchronous)	 C1: single axis M1: interpolation	 C1: single axis M1: interpolation
Maximum number of possible axes	Recommended: 8 axes Note: one axis is treated as a CANopen node. 128 nodes are possible (as defined by CANopen specifications).	Recommended: 8 axes Note: one axis is treated as a CANopen node. 128 nodes are possible (as defined by CANopen specifications).	Recommended: 8 axes Note: one axis is treated as a CANopen node. 128 nodes are possible (as defined by CANopen specifications).
Motion	<ul style="list-style-type: none"> • Point-to-point asynchronous • Every axis moves with its own pre-defined parameter • The axes do not reach their end positions at the same time and the path is not defined 		
			<ul style="list-style-type: none"> • 2.5D interpolation • PLC Open
Special features	Integrated controller in a display screen	Function integration on the CPX valve platform	
			<ul style="list-style-type: none"> • CNC editor • DXF import • Cam disk editor
Application examples	<ul style="list-style-type: none"> • Handling systems • Pick & place, palletising 		Path control, bonding, cutting, handling, flying saw, cam disk
Programming environment	CoDeSys	CoDeSys	CoDeSys + Softmotion

Modular control

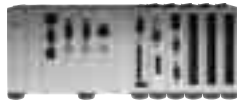

Modular control		CMXR robotic controller	
Modular controller CECX-C1	Motion controller CECX-M1	CMXR-C1 (Basic)	CMXR-C2 (Advanced)
<p>Single axis (point-to-point asynchronous)</p>	<p>Interpolation (2.5D)</p>	<p>Robotics (3D)</p>	<p>Robotics (3D)</p>
<p>Recommended: 8 axes Note: one axis is treated as a CANopen node. 128 nodes are possible (as defined by CANopen specifications).</p>		<p>Max. 6 interpolated axes, of which max. 3 basic axes and 1 orientation axis and max. 3 dependent auxiliary axes that are interpolated together with the kinematics system.</p>	
			<p>Additional single axes (not interpolated together with others) can be controlled via the integrated CoDeSys PLC. Recommended: 16 axes.</p>
		<p>3D contour interpolation with an orientation axis for kinematics systems with up to 4 degrees of freedom. E.g. 3D gantry with an axis of rotation on the front end.</p>	
	<ul style="list-style-type: none"> • 2.5D interpolation • PLC Open 		<p>CoDeSys control: point-to-point asynchronous</p>
<ul style="list-style-type: none"> • Powerful PLC • Encoder interface • Interrupt function • Fast clock pulse inputs • Profibus master • Two Canbus masters • RS 232/ RS 485-A/422-A 		<ul style="list-style-type: none"> • Economical design and configuration with the Festo Configuration Tool (FCT) • Simple programming of motions with Festo Teach Language (FTL), no specialist expertise required • Optional teach pendant with 2-channel permission button • Reduced speed in manual override mode • Automatic repositioning when continuing interrupted motions • Simple teaching of positions • Definition of tools, allowing easy use of multiple grippers • Real orientation axes on the front end • Integrated kinematics models e.g. for Cartesian systems, tripod, H- and T-gantries 	
	<ul style="list-style-type: none"> • CNC editor • DXF import • Cam disk editor 		<ul style="list-style-type: none"> • Increased flexibility with the integrated CoDeSys PLC, e.g. for the integration of vision systems • Tracking function for applications involving selecting items from a conveyor belt • Speed-independent path switching points with time compensation, e.g. for bonding applications • Complete automation of a cell is possible
<ul style="list-style-type: none"> • Handling systems • Pick & place, palletising 	<p>Path control, bonding, cutting, handling, flying saw, cam disk</p>	<p>Handling, palletising, bonding, metered dispensing, painting, cutting</p>	<p>Tracking applications such as processing of moving parts on a conveyor belt or synchronised kinematics movement with up to 6D</p>
CoDeSys	CoDeSys + Softmotion	Festo Teach Language (FTL)	FTL + CoDeSys