

Control block CPX-CEC



Control block CPX-CEC

Key features



Application

Controller

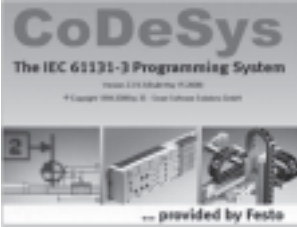

The CoDeSys controllers are modern control systems for CPX terminals that enable programming with CoDeSys to IEC 61131-3.

Programming in a global language

CoDeSys provided by Festo offers a convenient user interface with the following functions:

- Integrated module libraries
- Library administrator for integrating additional libraries
- Visualisation editor

- Simulation mode
- Integrated project documentation
- Debugging functions for fault finding
- Configuration and parameterisation of the controller using the control configuration

Basic functions

The CoDeSys controllers offer the following basic functions:

- Programming with CoDeSys to IEC 61131-3
- Communication via Ethernet (Modbus/TCP, EasyIP, TCP/IP)
- Process visualisation using operator unit FED or OPC server
- Communication via fieldbus in combination with a fieldbus node in the CPX terminal
- Diagnostics and quick commissioning of CPX modules via handheld CPX-MMI

CPX-CEC-C1 offers...

- All basic functions
- CANopen master for controlling 31 CANopen stations. Electric axes can be controlled in point-to-point mode

CPX-CEC-M1 offers...

- All basic functions
- CANopen master for controlling up to eight electric axes (recommended) in interpolated mode (two of these axes with circular interpolation and six additionally with linear interpolation)
- SoftMotion function library for coordinated multi-axis movements

CPX-CEC offers...

- All basic functions
- RS232 interface for operating external devices

Note
The SoftMotion functions are not available when the control block is operated as a CANopen master.

Note
When using external devices, data communication must be programmed by the user.

Bus connection

The CoDeSys controllers are remote controllers that can be connected to a higher-order PLC via the fieldbus nodes of the CPX terminal or via Ethernet, for example:

- PROFINET
- Ethernet/IP
- EtherCAT
- Profibus
- DeviceNet

Operating modes

- Stand-alone
- Remote controller on the fieldbus
- Remote controller on the Ethernet

System expansion

CANopen connects CPX-CEC... with valve terminals and electric drive controllers from Festo:

- CPX, CPV
- CMMP-AS, CMMS-AS/-ST, etc.
- AS-interface gateway, wireless gateway

Ethernet connects CPX-CEC... with additional controllers and operator units from Festo:

- CECX
- FED-50 to FED-5000
- FED-CEC
- Camera SBOx-Q

System expansion (examples)

CPX-CEC/CPX-CEC-... as a stand-alone or remote controller

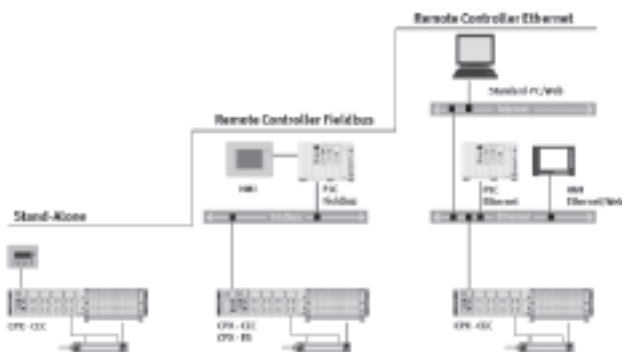

CPX-CEC-C1 as a CANopen fieldbus master

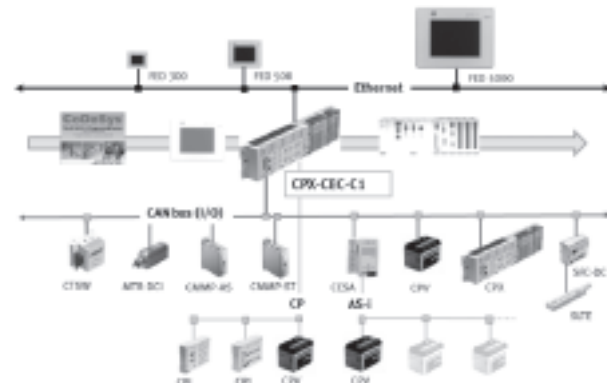

Control block CPX-CEC

Key features

Advantages for users	
<p>Increased performance</p> <p>Improved cycle times – more connectable actuators. Compatibility with almost all control systems on the market is ensured via the CPX terminal.</p>	<p>Reduced costs</p> <p>For standardised pre-processing: reduces installation costs as an intelligent remote I/O terminal to IP65/IP67 directly at the machine. CPX-CEC-... is ideally adapted to CPX and motion applications with up to 31 axes. We recommend operating the CPX-CEC-M1 with a maximum of eight axes.</p>
<p>Simple, yet efficient: decentralised structures</p> <p>The modular I/O system with up to 512 I/Os and CAN master functionality (CPX-CEC-...) offers complete flexibility, whether for open-loop or closed-loop control.</p>	<p>The only one in the world to IP65</p> <p>Stand-alone for low-cost automation of manual workstations, for example, or remote control with pre-processing. The fully integrated automation platform for standard, proportional and servopneumatics, sensors and motion control to IP65. Included: simple commissioning.</p>

Classification of CPX-CEC-... in the portfolio for multi-axis controllers for electric drive technology	
<p>Embedded controller</p> <p>The controller FED-CEC (CoDeSys) for insertion in the display and operator units from Festo facilitates compact solutions for small control tasks in combination with electric drive technology.</p>	<p>Modular controller</p> <p>The modular controllers complete the upper end of the range for actuating electric drives. The CEEX-X-C1 (CoDeSys) is the ideal expansion option for a control cabinet in combination with electric drive technology and general control technology.</p> <p>The CEEX-X-M1 (CoDeSys) executes advanced tasks such as cam disks, multi-axis function modules to PLCopen and simple NC functions up to 2.5D. The robot controller CMXR provides interpolating control for different kinematic systems (e.g. tripod) with up to six axes.</p>

CPX-CEC-... in the electric drive world

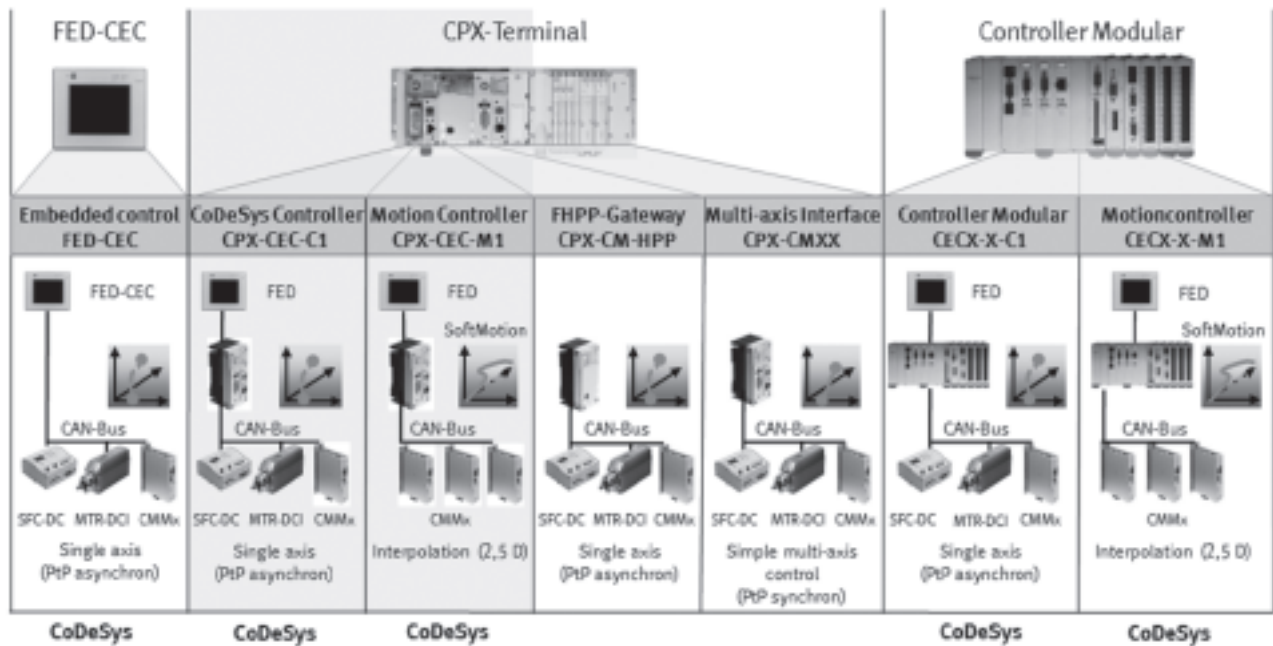

Control block CPX-CEC

Type codes

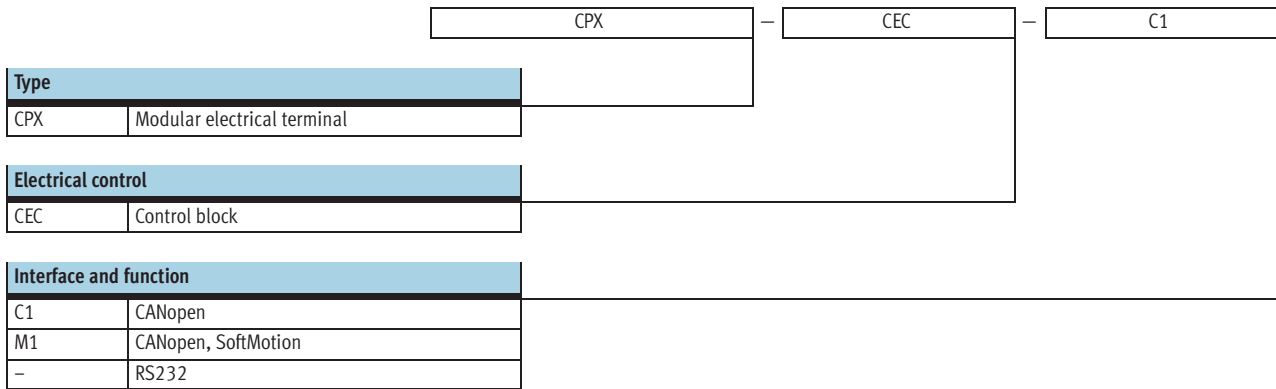

Control block CPX-CEC

Technical data

The CoDeSys controller is a modern control system for CPX terminals that enables programming with CoDeSys to IEC 61131-3.

- Easy actuation of valve terminal configurations with MPA, VTSA
- Connection to all fieldbuses as a remote controller and for preprocessing
- Actuation of electric drives as individual axes via CANopen (CPX-CEC-C1/-M1)
- Diagnostics with flexible monitoring options for pressure, flow rate, cylinder operating time, air consumption
- Early warnings and visualisation options
- Actuation of decentralised installation systems on the basis of CPI actuation of applications in proportional pneumatics
- Servopneumatic applications
- AS-interface actuation via gateway

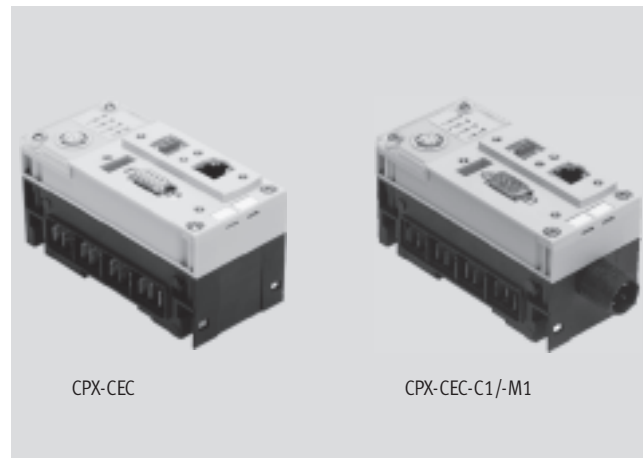

General technical data			
Type	CPX-CEC-C1	CPX-CEC-M1	CPX-CEC
Protocol	CoDeSys level 2		
	EasyIP		
	Modbus TCP		
	TCP/IP		
CPU data	32 MB RAM		
	32 MB flash		
	400 MHz processor		
Control interface	CAN bus		-
Processing time	Approx. 200 µs/1k instruction		
Baud rate	10/100 bps to IEEE 802.3 (10BaseT) or 802.3u (100BaseT _x)		
Programming software	CoDeSys provided by Festo		
Programming language	SFC, IL, FCH, LD and ST to IEC 61131-3		
	Additionally CFC		
Programming, operating language	German		
	English		
Programming, support for file handling	Yes		
Program memory	4 MB user program		
Flags	30 kB remanent memory		
	8 MB global data memory		
	CoDeSys variable concept		
Device-specific diagnostics	Diagnostic memory		
	Channel and module-oriented diagnostics		
	Undervoltage/short circuit of modules		
LED displays (bus-specific)	TP: Link/traffic		
LED displays (product-specific)	RUN: PLC status		
	STOP: PLC status		
	ERR: PLC runtime error		
	PS: Electronics supply, sensor supply		
	PL: Load supply		
	SF: System fault		
	M: Modify/forcing active		
Parameterisation	CoDeSys		
Configuration support	CoDeSys		
IP address setting	DHCP		
	Via CoDeSys		
	Via MMI		
Control elements	DIL switch for CAN termination		-
	Rotary switch for RUN/STOP		

Control block CPX-CEC

Technical data

FESTO

General technical data			
Type	CPX-CEC-C1	CPX-CEC-M1	CPX-CEC
Function blocks	CPX diagnostic status, copy CPX diagnostic trace, read CPX module diagnostics And others		
Additional functions	Diagnostic functions Motion functions for electric drives SoftMotion functions for electric drives Communication functions RS232		
Total number of axes	31	31 (recommended: max. 8)	–
Nominal operating voltage [V DC]	24		
Nominal operating voltage of the load voltage [V DC]	24 18 ... 30, without pneumatics 21.6 ... 26.4, with pneumatics type midi/maxi 20.4 ... 26.4, with pneumatics type CPA 18 ... 30, with pneumatics type MPA		
Power failure bridging [ms]	10		
Intrinsic current consumption at nominal operating voltage [mA]	Typically 85		
Protection class	IP65, IP67		
Dimensions W x L x H (incl. interlinking block) [mm]	50 x 107 x 55		
Product weight [g]	155		
Materials			
Housing	Reinforced polyamide, polycarbonate		
Note on materials	RoHS-compliant		

Technical data – Interfaces			
Type	CPX-CEC-C1	CPX-CEC-M1	CPX-CEC
Ethernet			
Number	1		
Ethernet interface	RJ45		
Connector plug	RJ45 socket, 8-pin		
Data transmission speed [Mbps]	10/100		
Supported protocols	TCP/IP Easy IP Modbus TCP (Server)		
Fieldbus interface			
Type	CAN bus		–
Connection technology	Sub-D plug, 9-pin		
Transmission rate [kbps]	125; 250; 500; 800; 1,000 Adjustable via software	125; 250; 500; 1,000 Adjustable via software	
Electrical isolation	Yes		
RS232 interface			
Data interface	–		Sub-D socket, 9-pin 9.6 ... 230.4 kbps Electrically isolated

Operating and environmental conditions			
Ambient temperature [°C]	–5 ... +50		
Storage temperature [°C]	–20 ... +70		
Relative air humidity [%]	95, non-condensing		
Corrosion resistance class CRC ¹⁾	2		

1) Corrosion resistance class 2 according to Festo standard 940 070
Components subject to moderate corrosion stress. Externally visible parts with primarily decorative surface requirements which are in direct contact with a normal industrial environment or media such as coolants or lubricating agents

Control block CPX-CEC

Technical data

Connection and display components

CPX-CEC-C1/-M1

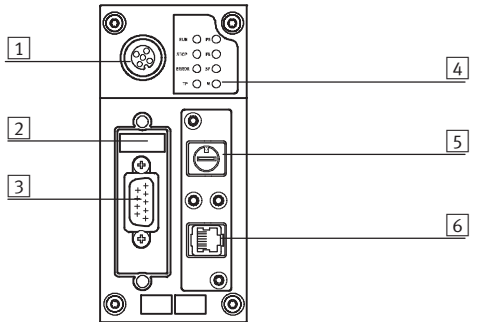

- 1 CPX-MMI connection
- 2 DIL switch
- 3 Fieldbus interface (plug, Sub-D, 9-pin)
- 4 Status LEDs, bus-specific and product-specific
- 5 RUN/STOP rotary switch
- 6 Ethernet interface (RJ45, socket, 8-pin)

CPX-CEC

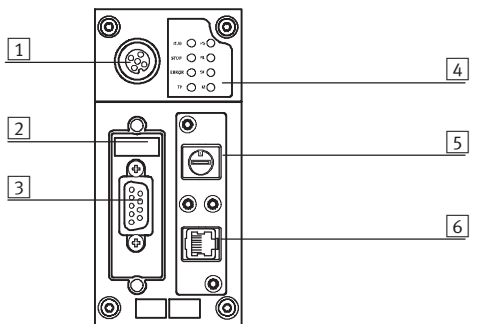

- 1 CPX-MMI connection
- 2 DIL switch
- 3 RS232 interface (socket, Sub-D, 9-pin)
- 4 Status LEDs, bus-specific and product-specific
- 5 RUN/STOP rotary switch
- 6 Ethernet interface (RJ45, socket, 8-pin)

Pin allocation – Fieldbus interface (CPX-CEC-C1/-M1)

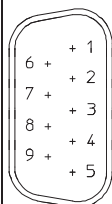
	Pin	Signal	Meaning
Sub-D plug			
	1	n.c.	Not connected
	2	CAN_L	CAN low
	3	CAN_GND	CAN ground
	4	n.c.	Not connected
	5	CAN_SHLD	Connection to functional earth (FE)
	6	CAN_GND	CAN ground (optional) ¹⁾
	7	CAN_H	CAN high
	8	n.c.	Not connected
	9	n.c.	Not connected
	Housing	Screened	Plug housing must be connected to FE

1) If a drive controller is connected to an external power supply, CAN ground (optional), pin 6, cannot be used on the CPX-CEC-C1/-M1.

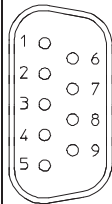

Pin allocation – RS232 interface (CPX-CEC)

	Pin	Signal	Meaning
Sub-D socket			
	1	n.c.	Not connected
	2	RxD	Received data
	3	TxD	Transmitted data
	4	n.c.	Not connected
	5	GND	Data reference potential
	6	n.c.	Not connected
	7	n.c.	Not connected
	8	n.c.	Not connected
	9	n.c.	Not connected
	Screened	Screened	Connection to functional earth

Control block CPX-CEC

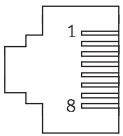

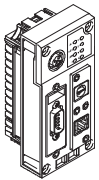



Technical data

Pin allocation – Ethernet interface			
	Pin	Signal	Meaning
RJ45 plug			
	1	TD+	Transmitted data+
	2	TD-	Transmitted data-
	3	RD+	Received data+
	4	n.c.	Not connected
	5	n.c.	Not connected
	6	RD-	Received data-
	7	n.c.	Not connected
	8	n.c.	Not connected
	Housing	Screened	Screened

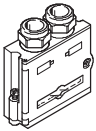
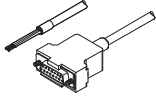
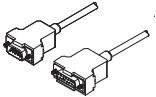
Ordering data			
Designation		Part No.	Type
	Control block	567347	CPX-CEC-C1
		567348	CPX-CEC-M1 
		567346	CPX-CEC 

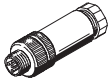
Control block CPX-CEC

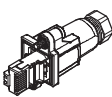
Accessories

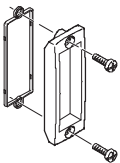
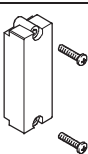
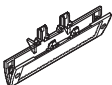
Ordering data – Bus connection			
Designation		Part No.	Type
	Sub-D plug, 9-pin (for CPX-CEC-C1/-M1)	532219	FBS-SUB-9-BU-2x5POL-B
	Connecting cable FED (for CPX-CEC)	539642	FEC-KBG7
	Connecting cable FED (for CPX-CEC)	539643	FEC-KBG8
	Bus connection, plug 2xM12, 5-pin	525632	FBA-2-M12-5POL
	Plug socket for fieldbus connection, M12, 5-pin	18324	FBSD-GD-9-5POL
	Plug, M12, 5-pin	175380	FBS-M12-5GS-PG9
	Bus connection, 5-pin	525634	FBA-1-SL-5POL
	Bus connection, screw terminal, 5-pin	525635	FBSD-KL-2x5POL
	RJ45 plug, 8-pin	534494	FBS-RJ45-8-GS
	Cover for RJ45 connection	534496	AK-RJ45
	Inspection cover, transparent for Sub-D plug/socket	533334	AK-SUB-9/15-B
	Cover for Sub-D plug/socket	557010	AK-SUB-9/15
	Inscription label holder for manifold block	536593	CPX-ST-1

Documentation			
Designation		Language	Part No. Type
	Manual for control block CPX-CEC/CPX-CEC-...	German	569121 P.BE-CPX-CEC-DE
		English	569122 P.BE-CPX-CEC-EN