

## Valve terminals type 33 MPA-F

**FESTO**



# Valve terminals type 33 MPA-F

Key features

FESTO

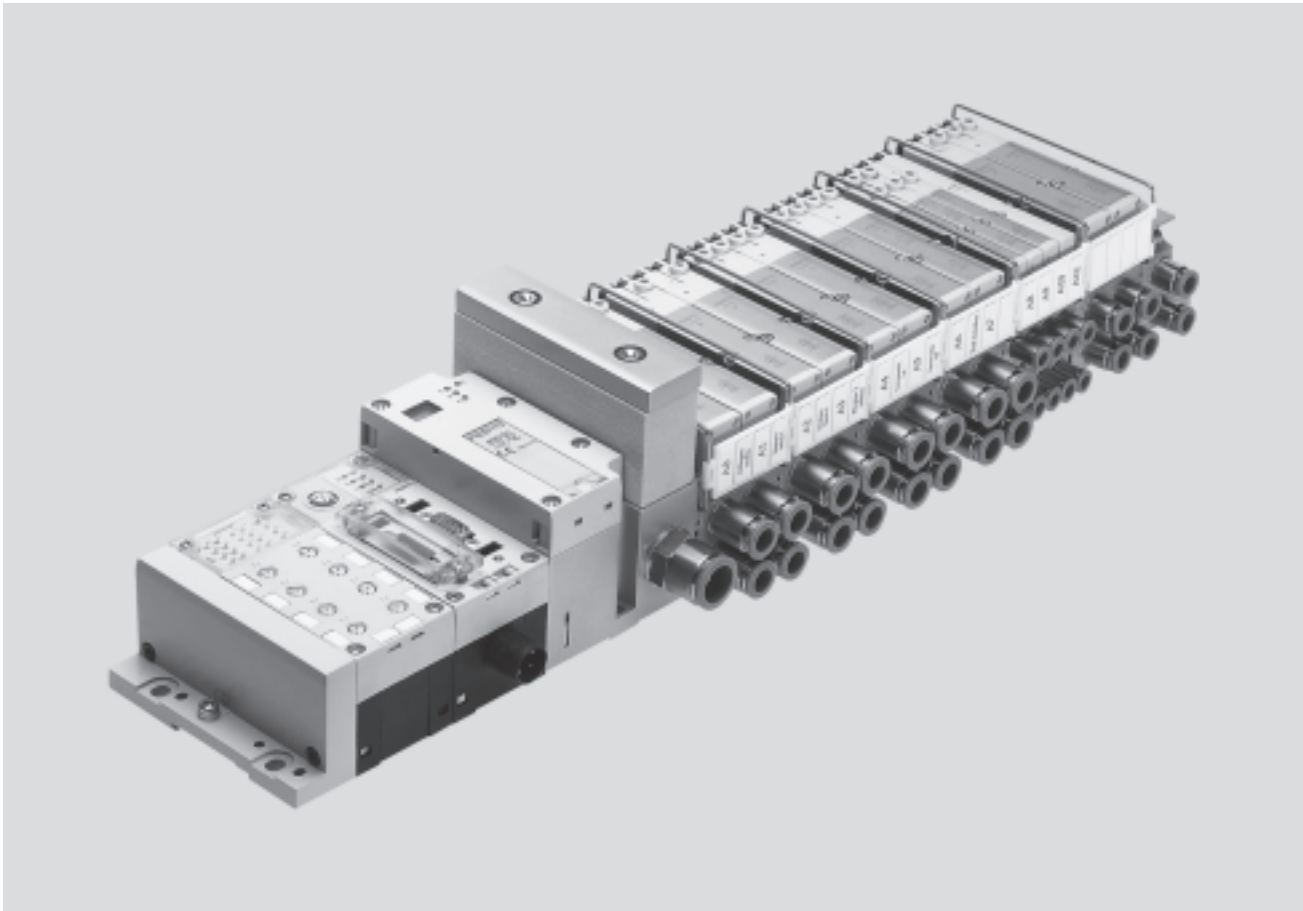

## Innovative

- Manifold blocks, tubing connections and exhausts designed for optimum flow rates
- Tubing diameters:
  - Working ports up to 10 mm
  - Supply ports up to 16 mm
- MPAF2 flow rates up to 900 l/min
- Valve terminal with multi-pin plug and fieldbus connections and control block
- Dream team: fieldbus valve terminal suitable for CPX electrical peripherals. This means:
  - Forward-looking internal communication system for controlling the valves and CPX modules
  - Diagnostics down to the individual valve
  - Valves can be actuated with or without (standard) isolated electrical circuits

## Versatile

- Modular system offering a range of configuration options
- Expandable up to 128 solenoid coils
- Conversions and extensions possible at a later date
- Selectable pilot air supply
- Integration of innovative function modules possible
- Manual pressure regulators, rotatable pressure gauges
- Pressure sensors integrated on the valve terminal
- Additional air supply via additional pressure zones using supply plates
- Wide range of pressures –0.9 ... 10 bar
- Wide range of valve functions

## Reliable

- Sturdy and durable metal components
  - Valves
  - Manifold blocks
  - Seals
- Fast troubleshooting thanks to LEDs on the valves and diagnostics via fieldbus
- Extensive operating voltage range  $\pm 25\%$
- Easy to service through replaceable valves and electronics modules
- Manual override either non-detenting, detenting or secured against unauthorised activation (covered)
- Durable, thanks to tried and tested spool valves
- Large, durable and comprehensive labelling system

## Easy to mount

- Tested and ready to install unit
- Lower selection, ordering, installation and commissioning costs
- Secure mounting on wall or H-rail
- Further manifold blocks can be assembled using just two screws and sturdy separating seals on metal separator plates

# Valve terminals type 33 MPA-F

## Key features

### Reduced downtimes:

Two-colour LED diagnostics on-site

Width 10 mm and 20 mm

Pneumatic interface to CPX with optional integrated pressure sensor

Simple electrical connections

- Multi-pin plug connection
- Fieldbus connection
- Control block

CPX diagnostic interface for hand-held devices (channel-oriented diagnostics down to the individual valve)

### Quick mounting:

Directly using screws or on an H-rail, automatic earthing

### Safe:

Operating voltage connection  $\pm 25\%$ , outputs and valves can be disconnected separately

### Reliable operation:

Manual override: non-detenting/detenting or covered

### Flexible:

- 64 valve positions/128 solenoid coils (FB)
- 24 valve positions/24 solenoid coils (MP)

### Functional:

Sturdy metal thread or pre-assembled QS fittings

### Modular:

Supply plates facilitate the creation of multiple pressure zones as well as numerous additional exhaust and supply ports

### Wide range of valve functions

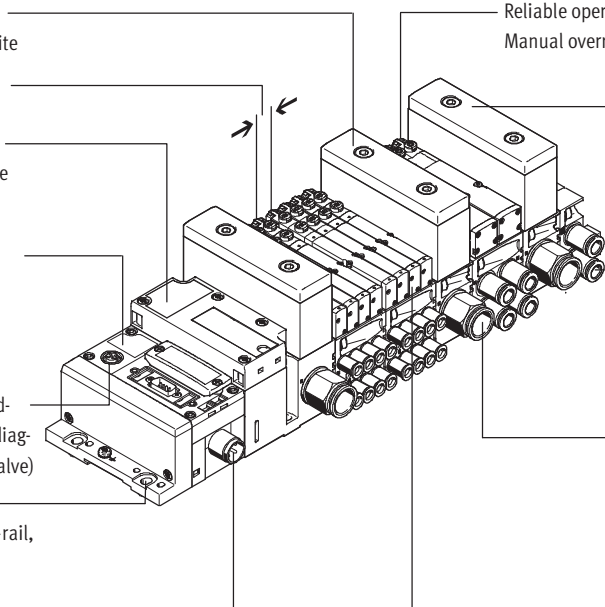

## Equipment options

### Valve functions

- |                                                                                                                                                                                                                                                                                        |                                                                                                                                                                                                                                                                            |                                                                                                                                                                                                                                                                                                                                   |                                                                                                                                                                                                       |
|----------------------------------------------------------------------------------------------------------------------------------------------------------------------------------------------------------------------------------------------------------------------------------------|----------------------------------------------------------------------------------------------------------------------------------------------------------------------------------------------------------------------------------------------------------------------------|-----------------------------------------------------------------------------------------------------------------------------------------------------------------------------------------------------------------------------------------------------------------------------------------------------------------------------------|-------------------------------------------------------------------------------------------------------------------------------------------------------------------------------------------------------|
| <ul style="list-style-type: none"> <li>• 5/2-way valve, single solenoid</li> <li>• 5/2-way valve, double solenoid</li> <li>• 2x 3/2-way valve, normally open</li> <li>• 2x 3/2-way valve, normally closed</li> <li>• 2x 3/2-way valve, 1x normally open, 1x normally closed</li> </ul> | <ul style="list-style-type: none"> <li>• 5/3-way valve, mid-position pressurised</li> <li>• 5/3-way valve, mid-position closed</li> <li>• 5/3-way valve, mid-position exhausted</li> <li>• 2x 2/2-way valve, 1x normally closed, 1x normally closed, reversible</li> </ul> | <ul style="list-style-type: none"> <li>• 2x 2/2-way valve, normally closed</li> <li>• 1x 3/2-way valve, normally closed, external compressed air supply</li> <li>• 1x 3/2-way valve, normally open, external compressed air supply</li> <li>• Manual pressure regulators</li> <li>• Pressure sensors can be integrated</li> </ul> | <p>All valves have the same compact dimensions with an overall length of 107 mm and a width of 10.5 mm or 21 mm. A height of 55 mm makes them a perfect match for the electrical peripherals CPX.</p> |
|----------------------------------------------------------------------------------------------------------------------------------------------------------------------------------------------------------------------------------------------------------------------------------------|----------------------------------------------------------------------------------------------------------------------------------------------------------------------------------------------------------------------------------------------------------------------------|-----------------------------------------------------------------------------------------------------------------------------------------------------------------------------------------------------------------------------------------------------------------------------------------------------------------------------------|-------------------------------------------------------------------------------------------------------------------------------------------------------------------------------------------------------|

### Special features

#### Multi-pin plug terminal

- Max. 24 valve positions/ max. 24 solenoid coils
- Parallel modular valve linking via circuit boards
- Electronics module with integrated holding current reduction
- Any compressed air supply
- Creating pressure zones

#### Fieldbus terminal/control block

- Max. 64 valve positions/ max. 128 solenoid coils
- Internal CPX bus system for valve actuation
- Module for electrical valve actuation, with or without isolated electrical circuits

- Any compressed air supply
- Creating pressure zones
- Electrical module with extended diagnostics
  - Short circuit detection
  - Open load detection
  - Condition counter

#### Combinable

- MPAF1 flow rates of up to 360 l/min
- MPAF2 flow rates of up to 900 l/min
- MPAF1 and MPAF2 can be combined on one valve terminal

### Electrical supply plate

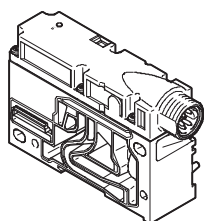

- Increases the maximum number of valve positions possible to 64, with max. 128 solenoid coils
- Creation of isolated, individually disconnectable electrical circuits (voltage zones)
- Greater economy thanks to the higher number of valves/solenoid coils per valve terminal
- Greater safety through individual disconnection of valve groups, for example for EMERGENCY-STOP functions

 Note  
The electrical supply plate is available with either an M18 or 7/8" connection.

# Valve terminals type 33 MPA-F

Key features

FESTO

## Valve terminal configurator

Online via: → [www.festo.com](http://www.festo.com)

The appropriate MPA-F valve terminal can be chosen quickly and easily using the online catalogue. This includes an easy-to-use valve terminal configurator. This makes it much easier to find the right product.

The valve terminals are fully assembled according to your order specification and are individually tested. This reduces assembly and installation time to a minimum.

The valve terminal type 33 is ordered using the order code.

Ordering system for type 33

→ Internet: mpaf

Ordering system for CPX

→ Internet: cpx

## Multi-pin plug connection

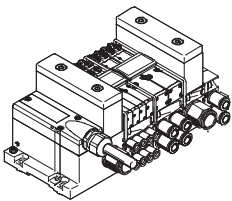

The signal flow from the controller to the valve terminal takes place via a pre-assembled or self-assembled multi-wire cable to the multi-pin plug connection, which substantially reduces installation time.

The valve terminal can be equipped with max. 24 solenoid coils. This corresponds to 4 to 24 MPA1 or 2 to 24 MPA2 valves, or a combination of both.

Versions

- Sub-D connection
- Pre-assembled multi-pin cable
- Multi-pin cable for self-assembly

## Fieldbus connection via the CPX system

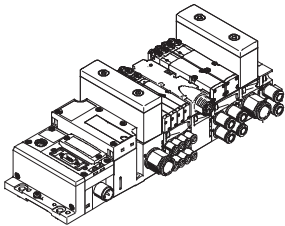

An integrated fieldbus node manages communication with a higher-order PLC. This enables a space-saving pneumatic and electronic solution.

Valve terminals with fieldbus interfaces can be configured with up to 16 manifold blocks. In conjunction with MPAF1 and 8 solenoid coils per manifold block, up to 128 solenoid coils can thus be actuated. An MPAF2 with 4 solenoid coils per manifold block can actuate 64 solenoid coils.

Versions

- Profibus DP
  - ProfiNet
  - Interbus
  - DeviceNet connection
  - CANopen
  - CC-Link
  - Ethernet/IP
  - Front End Controller Remote
  - Front End Controller Remote I/O
  - Modbus/TCP
  - Profinet IO
  - CPX terminal
- Internet: cpx

## Control block connection via the CPX system

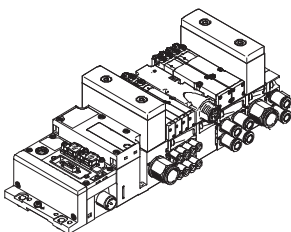

Controllers integrated in the Festo valve terminals enable the construction of stand-alone control units to IP65, without control cabinets.

Using the slave operation mode, these valve terminals can be used for intelligent pre-processing and are therefore ideal modules for designs using decentralised intelligence.

In the master operation mode, valve terminal groups can be designed with many options and functions, which can autonomously control a medium sized machine/system.

- CPX terminal
- Internet: cpx

# Valve terminals type 33 MPA-F

Key features

## CP string extension

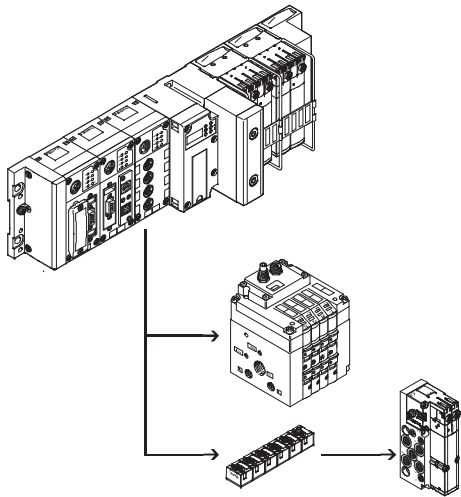

The optional string extension enables additional valve terminals and I/O modules to be connected to the fieldbus node of the CPX terminal. Different input and output modules as well as CPV-SC, CPV and CPA valve terminals can be connected. The maximum length of the CP string extension is 10 metres, which means that the extension modules can be mounted directly on-site. All of the required electrical signals are transmitted via the CP cable, which in turn means that no further installation is needed on the extension module.

The CP string interface offers:

- 32 input signals
- 32 output signals for output modules 24 V DC or solenoid coils
- Logic and sensor supply for the input modules
- Load voltage supply for the valve terminals
- Logic supply for the output modules

# Valve terminals type 33 MPA-F

Peripherals overview

## Modular pneumatic components

The modular design of the MPA-F facilitates maximum flexibility right from the planning stage and offers maximum ease of servicing during operation.

The system consists of manifold blocks and valves. The manifold blocks are screwed together and thus form the support system for the valves.

They contain the connection ducts for supplying compressed air to and venting from the valve terminal as well as the working lines for the pneumatic drives for each valve.

Each manifold block is connected to the next using three screws. Individual terminal sections can be isolated and further manifold blocks inserted by loosening these screws. This ensures that the valve terminal can be rapidly and reliably extended.

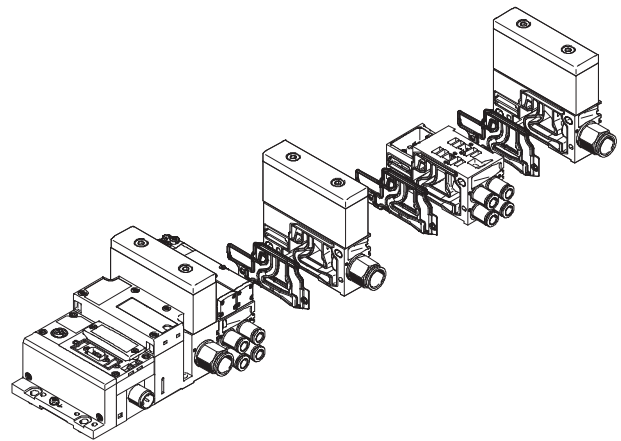
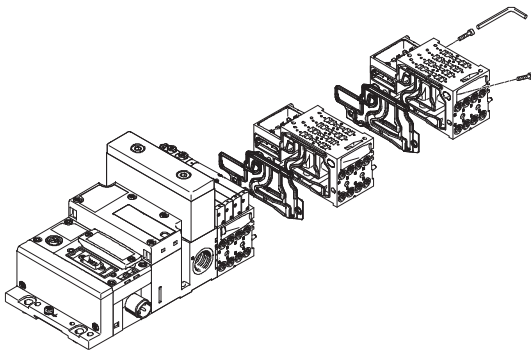

## Modular electrical peripherals

The manner in which the valves are actuated differs according to whether you are using a multi-pin terminal or fieldbus terminal. The MPA-F with CPX interface is based on the internal bus system of the CPX and uses this serial communication system for all solenoid coils and a range of electrical input and output functions.

Serial linking facilitates the following:

- Transmission of switching information
- High valve density
- Compact design
- Position-based diagnostics

- Separate voltage supply for valves
- Flexible conversion without address shifting
- Transmission of status, parameter and diagnostic data
- Internet: cpx

- CPX-FEC as autonomous controller with access via Ethernet and web server

## MPA-F with electrical peripherals CPX

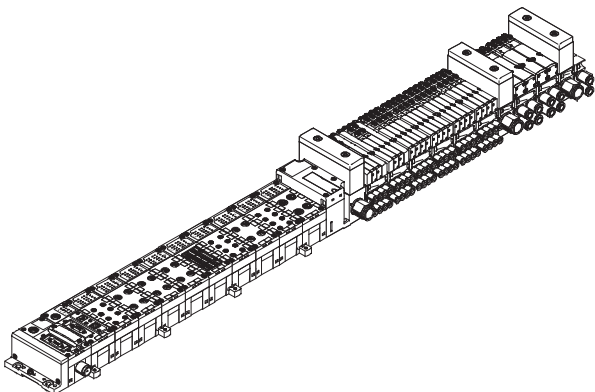

## Modularity with electrical peripherals CPX

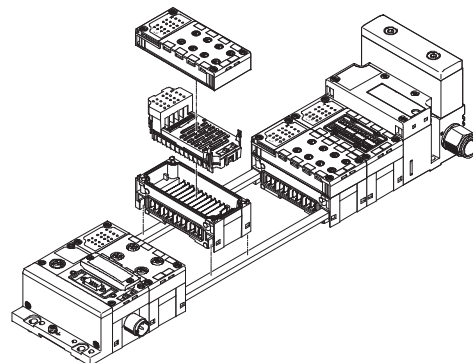

# Valve terminals type 33 MPA-F

Peripherals overview

## Valve terminal pneumatics

The manifold blocks are either prepared for:

- 2 or 4 valves with one solenoid coil
- 2 or 4 valves with two solenoid coils
- Valve positions for two solenoid coils can be equipped with any valve or a blanking plate.
- Valve positions for one solenoid coil can only be equipped with valves of this type (e.g. 5/2-way valve, single solenoid).

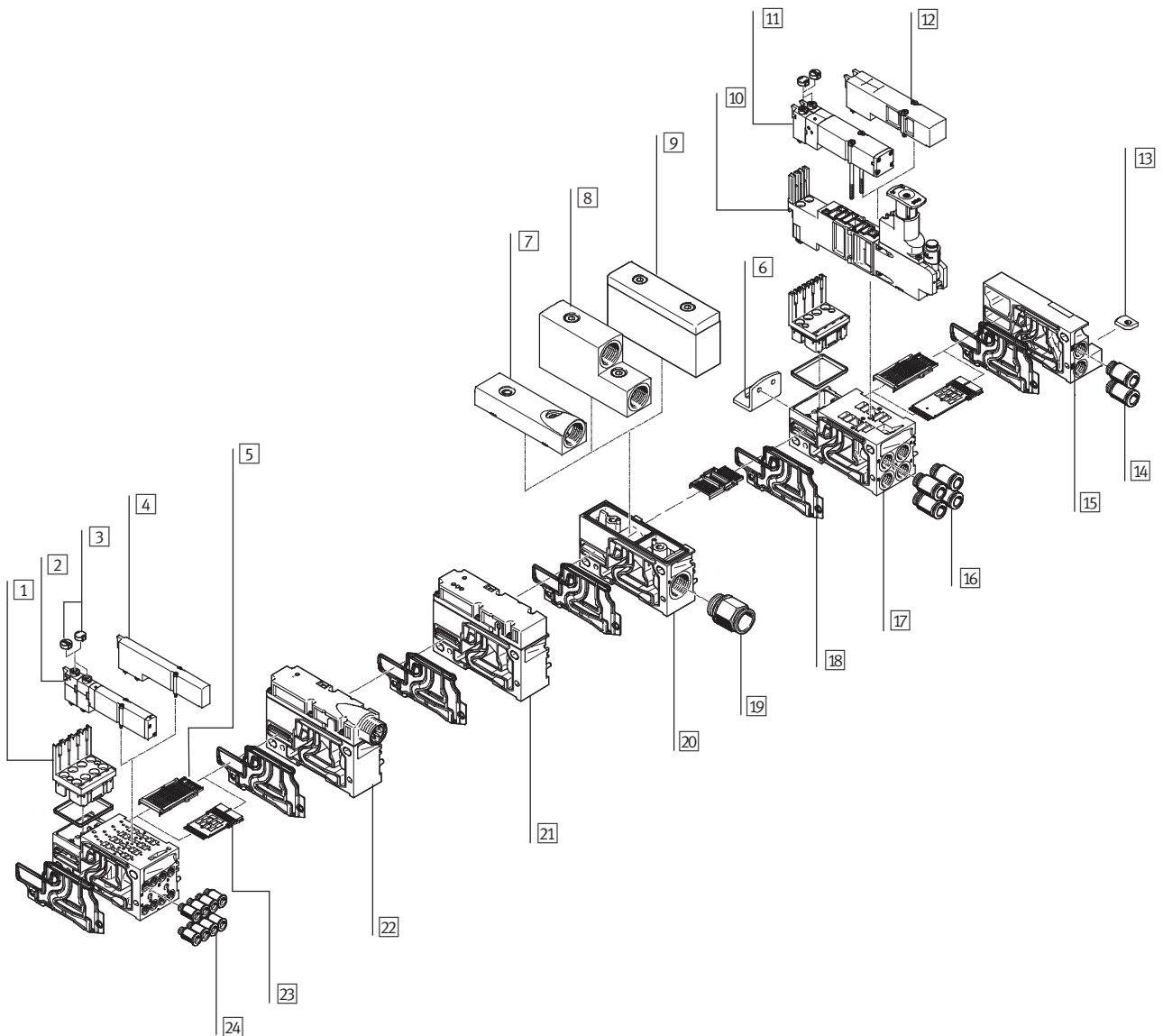

# Valve terminals type 33 MPA-F

Peripherals overview

Valve terminal pneumatics			
Designation	Brief description	→ Page/Internet	
1	Electronics module	For MPA-F size 1 or size 2	52
2	Solenoid valve	Size 1	49
3	Cover cap for manual override	Conversion from detenting/non-detenting to non-detenting or covered	–
4	Blanking plate	For unused valve position (vacant position), size 1	53
5	Electrical interlinking module	For fieldbus connection	52
6	Mounting bracket	Optional for valve terminal mounting	50
7	Plate	Exhaust plate for ducted exhaust air (port 3/5 combined)	53
8	Plate	Exhaust plate for ducted exhaust air (port 3/5 separate)	53
9	Plate	Flat plate silencer	54
10	Regulator plate	Size 2	50
11	Solenoid valve	Size 2	49
12	Blanking plate	For unused valve position (vacant position), size 2	53
13	H-rail mounting	–	50
14	Fittings	For right-hand end plate	51
15	Right-hand end plate	–	51
16	Fittings	For working ports	54
17	Manifold block	Size 2	51
18	Separating seal	For manifold block	53
19	Fitting	For pneumatic supply plate	54
20	Supply plate	–	53
21	Pressure sensor	–	51
22	Electrical supply plate	For additional power supply for large valve terminals (only with fieldbus)	51
23	Electrical interlinking module	For multi-pin plug connection	52
24	Fittings	For working ports	52



# Valve terminals type 33 MPA-F

Peripherals overview

## Valve terminal with multi-pin plug connection

Order code:

- 33P-... for the pneumatic components
- 33E-... for the electrical components

MPA-F valve terminals with multi-pin plug connection can be expanded by up to 24 solenoid coils.

The multi-pin plug connection is designed as a removable 25-pin Sub-D connection to IP65.

The cable can be selected when ordering:

- 2.5 m
- 5 m
- 10 m

Each can be used for max. 8 or 24 valves.

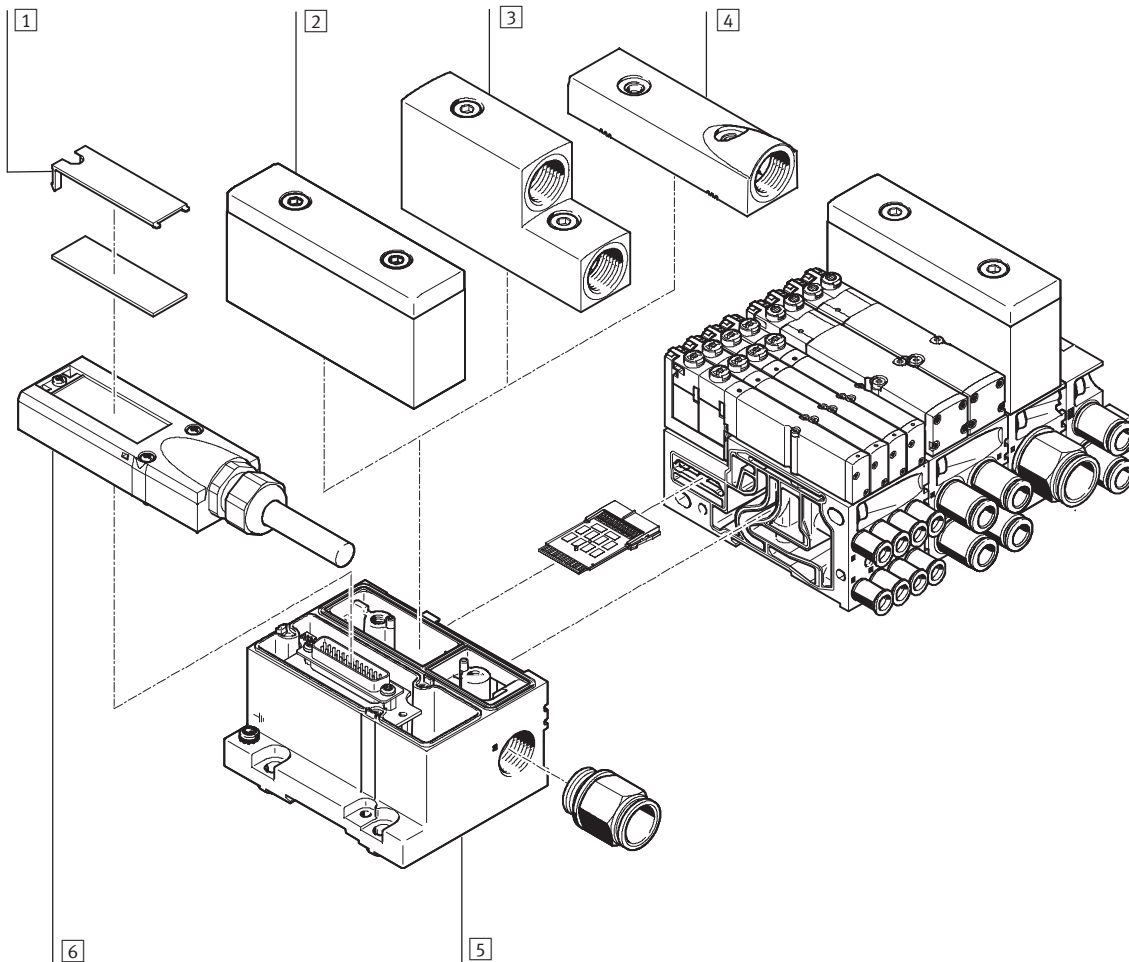

Designation	Brief description	→ Page/Internet
1 Inscription labels	Large, for multi-pin plug connection	-
2 Plate	Flat plate silencer for pneumatic interface	54
3 Plate	Exhaust plate for ducted exhaust air (port 3/5 separate)	53
4 Plate	Exhaust plate for ducted exhaust air (port 3/5 combined)	53
5 Electrical interface	For multi-pin plug	51
6 Multi-pin plug connection	With multi-pin cable	52

# Valve terminals type 33 MPA-F

Peripherals overview

## Valve terminal with fieldbus connection, control block (electrical peripherals CPX)

Order code:

- 33P-... for the pneumatic components
- 50E-... for the electrical components

Valve terminals with fieldbus interfaces can be configured with up to 16 manifold blocks. In conjunction with MPAF1 and 8 solenoid coils per manifold block, up to 128 solenoid coils can thus be actuated. An MPAF2 with 4 solenoid coils per manifold block can actuate 64 solenoid coils.

Each valve position can be equipped with any valve or a blanking plate for future extensions. The rules for CPX apply to the equipment that can be used in combination with the electrical peripherals CPX.

- Digital inputs/outputs
- Analogue inputs/outputs
- Parameterisation of inputs and outputs
- Integrated convenient diagnostic system
- Preventive maintenance concepts

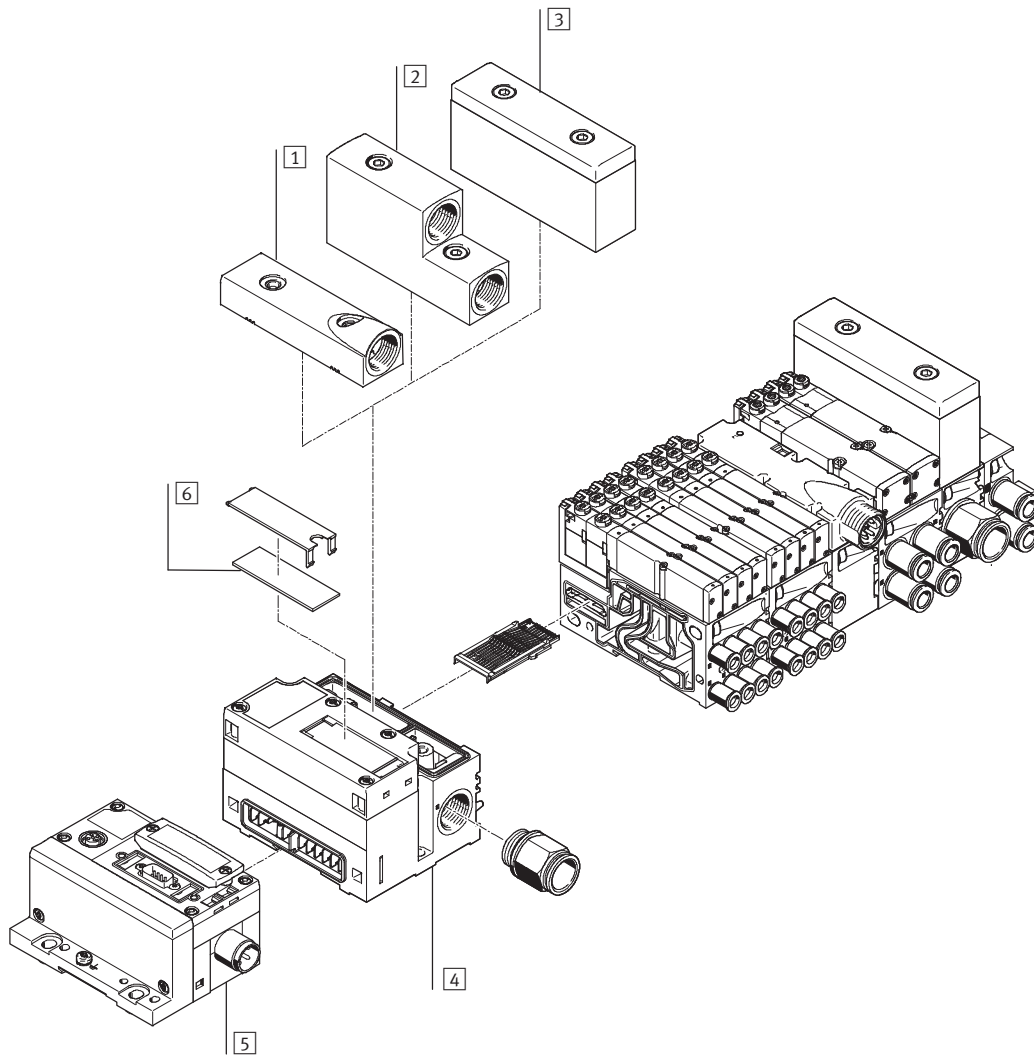

Designation	Brief description	→ Page/Internet	
1	Plate	Exhaust plate for ducted exhaust air (port 5/3 combined)	53
2	Plate	Exhaust plate for ducted exhaust air (port 5/3 separate)	53
3	Plate	Flat plate silencer for pneumatic interface	54
4	End plate	Pneumatic interface for CPX modules	51
5	Electrical interface	CPX module	-
6	Inscription label	Large, for end plate	-

# Valve terminals type 33 MPA-F

Key features – Pneumatic components

## Sub-base valve

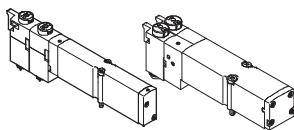

MPA-F offers a comprehensive range of valve functions. All valves are equipped with piston spool and patented sealing system which facilitates efficient sealing, a broad pressure range and long service life. They have a pneumatic pilot control for optimising performance. Air is supplied by means of pilot air supply.

Sub-base valves can be quickly replaced since the tubing connectors remain on the manifold block. This design is also particularly flat.

Irrespective of the valve function there are sub-base valves with one solenoid coil (single solenoid) or with two solenoid coils (double solenoid or two single solenoid valves in one housing).

## Constructional design

### Valve replacement

The valves are attached to the metal manifold block using two screws, which means that they can be easily

replaced. The mechanical sturdiness of the manifold block guarantees excellent long-term sealing.

### Extension

Blanking plates can be replaced by valves at a later date. The dimensions, mounting points and existing pneumatic installations remain unchanged during this process.

The valve code (M, J, N, NS, K, KS, H, HS, B, G, E, X, W, D, DS, I) is located on the front of the valve beneath the manual override.

Valve function				
Code	Circuit symbol	Size		Description
		1	2	
M		■	■	5/2-way valve, single solenoid <ul style="list-style-type: none"> <li>• Pneumatic spring return</li> <li>• Reversible</li> <li>• Suitable for vacuum</li> </ul>
J		■	■	5/2-way valve, double solenoid <ul style="list-style-type: none"> <li>• Reversible</li> <li>• Suitable for vacuum</li> </ul>
N		■	■	2x 3/2-way valve, single solenoid <ul style="list-style-type: none"> <li>• Normally open</li> <li>• Pneumatic spring return</li> <li>• Operating pressure &gt; 3 bar</li> </ul>
NS		■	–	2x 3/2-way valve, single solenoid <ul style="list-style-type: none"> <li>• Normally open</li> <li>• Mechanical spring return</li> <li>• Operating pressure –0.9 ... +8 bar</li> </ul>
K		■	■	2x 3/2-way valve, single solenoid <ul style="list-style-type: none"> <li>• Normally closed</li> <li>• Pneumatic spring return</li> <li>• Operating pressure &gt; 3 bar</li> </ul>
KS		■	–	2x 3/2-way valve, single solenoid <ul style="list-style-type: none"> <li>• Normally closed</li> <li>• Mechanical spring return</li> <li>• Operating pressure –0.9 ... +8 bar</li> </ul>

# Valve terminals type 33 MPA-F

Key features – Pneumatic components



Valve function				
Code	Circuit symbol	Size		Description
		1	2	
H		■	■	2x 3/2-way valve, single solenoid <ul style="list-style-type: none"> <li>• Normal position                             <ul style="list-style-type: none"> <li>– 1x closed</li> <li>– 1x open</li> </ul> </li> <li>• Pneumatic spring return</li> <li>• Operating pressure &gt; 3 bar</li> </ul>
HS		■	–	2x 3/2-way valve, single solenoid <ul style="list-style-type: none"> <li>• Normal position                             <ul style="list-style-type: none"> <li>– 1x closed</li> <li>– 1x open</li> </ul> </li> <li>• Mechanical spring return</li> <li>• Operating pressure –0.9 ... +8 bar</li> </ul>
B		■	■	5/3-way valve <ul style="list-style-type: none"> <li>• Mid-position pressurised<sup>1)</sup></li> <li>• Mechanical spring return</li> <li>• Reversible</li> <li>• Suitable for vacuum</li> </ul>
G		■	■	5/3-way valve <ul style="list-style-type: none"> <li>• Mid-position closed<sup>1)</sup></li> <li>• Mechanical spring return</li> <li>• Reversible</li> <li>• Suitable for vacuum</li> </ul>
E		■	■	5/3-way valve <ul style="list-style-type: none"> <li>• Mid-position exhausted<sup>1)</sup></li> <li>• Mechanical spring return</li> <li>• Reversible</li> <li>• Suitable for vacuum</li> </ul>
X		■	■	1x 3/2-way valve, single solenoid <ul style="list-style-type: none"> <li>• Normally closed</li> <li>• External compressed air supply</li> <li>• Pneumatic spring return</li> <li>• Reversible</li> </ul> Compressed air (–0.9 ... +10 bar) supplied at working port 4 can be switched with both internal and external pilot air supply.
W		■	■	1x 3/2-way valve, single solenoid <ul style="list-style-type: none"> <li>• Normally open</li> <li>• External compressed air supply</li> <li>• Pneumatic spring return</li> <li>• Reversible</li> </ul> Compressed air (–0.9 ... +10 bar) supplied at working port 2 can be switched with both internal and external pilot air supply.
D		■	■	2x 2/2-way valve <ul style="list-style-type: none"> <li>• Normally closed</li> <li>• Pneumatic spring return</li> <li>• Operating pressure &gt; 3 bar</li> </ul>
DS		■	–	2x 2/2-way valve <ul style="list-style-type: none"> <li>• Normally closed</li> <li>• Mechanical spring return</li> <li>• Operating pressure –0.9 ... +8 bar</li> </ul>

1) If neither solenoid coil is energised, the valve moves to its mid-position by means of spring force.  
If both coils are energised at the same time, the valve remains in the previously assumed switching position.

# Valve terminals type 33 MPA-F

Key features – Pneumatic components

Valve function				
Code	Circuit symbol	Size		Description
		1	2	
I		■	■	2x 2/2-way valve <ul style="list-style-type: none"> <li>• 1x normally closed</li> <li>• 1x normally closed, reversible</li> <li>• Pneumatic spring return</li> <li>• Operating pressure &gt; 3 bar</li> <li>• Vacuum at port 3/5 only</li> </ul>

- Note  
 A filter must be installed upstream of valves operated in vacuum mode. This prevents any foreign matter in the intake air getting into the valve (e.g. when operating a suction cup).

# Valve terminals type 33 MPA-F

Key features – Pneumatic components

FESTO

## Vertical stacking

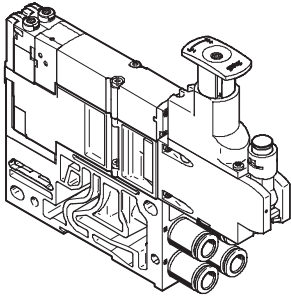

Additional functions can be added to each valve position between the manifold and the valve.

These functions are known as vertical stacking modules, and enable special

functioning or control of an individual valve position.

## Vertical stacking components

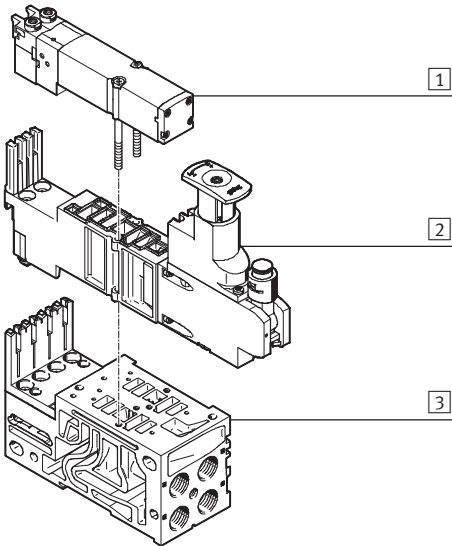

- 1 VMPA2 valve
- 2 Pressure regulator plate
- 3 Manifold designed for optimum flow rates

## Vertical stacking

### Pressure regulator plate

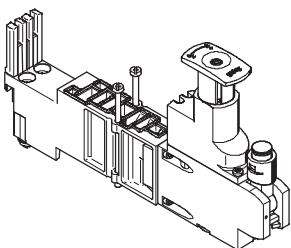

An adjustable pressure regulator can be installed between the manifold block and the valve in order to control the force of the triggered actuator.

This pressure regulator maintains a constant output pressure (secondary side) independent of pressure fluctuations (primary side) and air consumption.

Standard version:

- For supply pressure up to 6 bar or up to 10 bar
- Without pressure gauge (optional)
- Regulator knob with 3 positions (locked, reference position, free running)

# Valve terminals type 33 MPA-F

Key features – Pneumatic components

## Vertical stacking

Mode of operation of pressure regulator plate (P regulator) for port 1; code: PA, PF

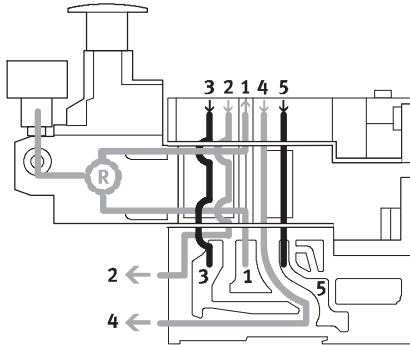

This pressure regulator regulates the pressure upstream of the valve in duct 1. Ducts 2 and 4 thus have the same regulated pressure.

During venting, the exhaust flow in the valve is from duct 2 to duct 3 and from duct 4 to duct 5.

## Advantages

- The pressure regulator is not affected by venting, since the pressure is regulated upstream of the valve.
- The pressure regulator can always be adjusted and read, since the pressure from the valve terminal is always present.

## Application examples

- An equal working pressure is required at working ports 2 and 4.
- A lower working pressure (e.g. 3 bar) than the operating pressure present on the valve terminal (e.g. 8 bar) is required.

Mode of operation of the pressure regulator plate (B regulator) for port 2; code: PC, PH

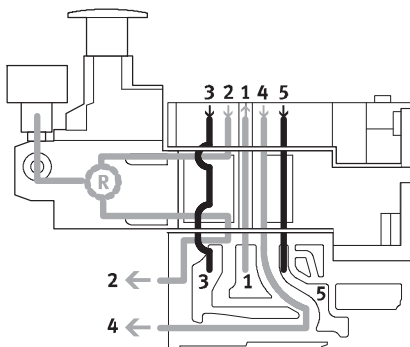

This pressure regulator regulates the pressure in duct 2 after the pressure medium flows through the valve. During venting, the exhaust flow in the valve is from duct 2 to duct 3 via the pressure regulator.

## Restrictions

The pressure regulator can only be adjusted in switched state (e.g. the valve is switched to 2 and exhaust flow is from 4 to 5).

## Application example

Reduced pressure at port 2. Operating pressure at port 4.

# Valve terminals type 33 MPA-F

Key features – Pneumatic components



## Vertical stacking

Mode of operation of the pressure regulator plate (A regulator) for port 4; code: PB, PK

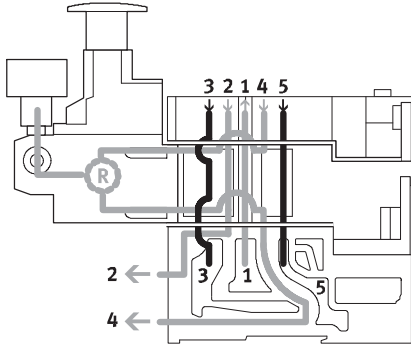

This pressure regulator regulates the pressure in duct 4 after the pressure medium flows through the valve. During venting, the exhaust flow in the valve is from duct 4 to duct 5 via the pressure regulator.

## Restrictions

The pressure regulator can only be adjusted in switched state (e.g. the valve is switched to 4 and exhaust flow is from 2 to 3).

## Application example

Reduced pressure at port 4. Operating pressure at port 2.

Mode of operation of the pressure regulator plate (B regulator, reversible) for port 2, reversible; code: PL, PN

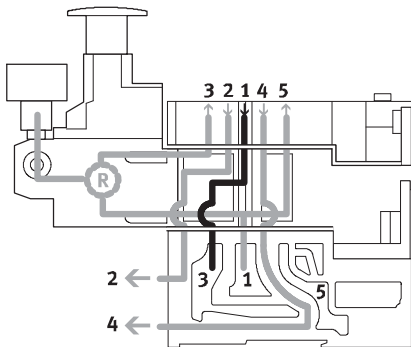

The reversible B regulator splits the supply air in duct 1 and regulates the pressure upstream of the valve in duct 3 (the unregulated pressure from duct 1 is in duct 5). The regulated air is then supplied to duct 2. The valve is thus operated in reversible mode.

During venting, the exhaust flow in the valve is from duct 2 to duct 1 and it is reversed into the manifold block via the intermediate plate to duct 3.

## Application examples

- When instead of the operating pressure of the valve terminal, a different pressure is required in duct 2.
- When fast venting is required.
- When the pressure regulator must always be adjustable.

 Note

Reversible pressure regulator plates may only be combined with valves that can be operated in reversible mode.

## Advantages

- Fast cycle times.
- 50% higher exhaust flow rate, as air is not exhausted via the pressure regulator. The load on the pressure regulator is also reduced.
- No quick exhaust valves are required.
- Operating pressure is always present at the pressure regulator, as the pressure is regulated upstream of the valve, i.e. the regulator can always be adjusted.

## Restrictions

- 2x 3/2-way valves (code N, K, H) are not used, as pressure is present at ports 3 and 5.



# Valve terminals type 33 MPA-F

Key features – Pneumatic components

## Vertical stacking

Mode of operation of the pressure regulator plate (A regulator, reversible) for port 4, reversible; code: PK, PM

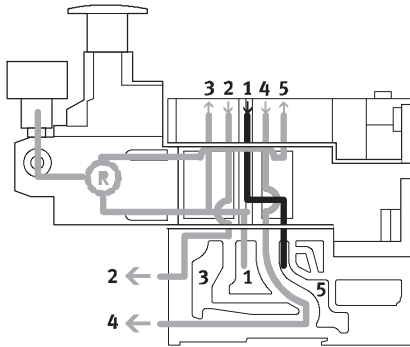

The reversible A regulator splits the working air in duct 1 and supplies the pressure upstream of the valve into duct 5 (the unregulated pressure from duct 1 is in duct 3). The regulated air is then supplied to duct 4. The valve is thus operated in reversible mode.

During venting, the exhaust flow in the valve is from duct 4 to duct 1 and it is reversed into the manifold block via the intermediate plate to duct 5.

## Application examples

- When instead of the operating pressure of the valve terminal, a different pressure is required in duct 4.
- When fast venting is required.
- When the pressure regulator must always be adjustable.



Note

Reversible pressure regulator plates may only be combined with valves

that can be operated in reversible mode.

## Advantages

- Fast cycle times.
- 50% higher exhaust flow rate, as air is not exhausted via the pressure regulator. The load on the pressure regulator is also reduced.
- No quick exhaust valves are required.
- Operating pressure is always present at the pressure regulator, as the pressure is regulated upstream of the valve, i.e. the regulator can always be adjusted.

## Restrictions

- 2x 3/2-way valves (code N, K, H) cannot be used, as pressure is present at ports 3 and 5.

# Valve terminals type 33 MPA-F

Key features – Pneumatic components



Vertical stacking – Pressure regulator plate							
Code		Type	Size		Supply pressure		Description
			1	2	6 bar	10 bar	
Pressure regulator plate for port 1 (P regulator)							
PA		VMPA2-B8-R1C2-C-10	-	■	-	■	<ul style="list-style-type: none"> <li>Regulates the operating pressure in duct 1 upstream of the directional control valve</li> </ul>
PF		VMPA2-B8-R1C2-C-06	-	■	■	-	
Pressure regulator plate for port 2 (B regulator)							
PC		VMPA2-B8-R2C2-C-10	-	■	-	■	<ul style="list-style-type: none"> <li>Regulates the operating pressure in duct 2 downstream of the directional control valve</li> </ul>
PH		VMPA2-B8-R2C2-C-06	-	■	■	-	
Pressure regulator plate for port 4 (A regulator)							
PB		VMPA2-B8-R3C2-C-10	-	■	-	■	<ul style="list-style-type: none"> <li>Regulates the operating pressure in duct 4 downstream of the directional control valve</li> </ul>
PG		VMPA2-B8-R3C2-C-06	-	■	■	-	
Pressure regulator plate for port 2, reversible (B regulator)							
PL		VMPA2-B8-R6C2-C-10	-	■	-	■	<ul style="list-style-type: none"> <li>Reversible pressure regulator for port 2</li> </ul>
PN		VMPA2-B8-R6C2-C-06	-	■	■	-	
Pressure regulator plate for port 4, reversible (A regulator)							
PK		VMPA2-B8-R7C2-C-10	-	■	-	■	<ul style="list-style-type: none"> <li>Reversible pressure regulator for port 4</li> </ul>
PM		VMPA2-B8-R7C2-C-06	-	■	■	-	

# Valve terminals type 33 MPA-F

Key features – Pneumatic components

## Blanking plate

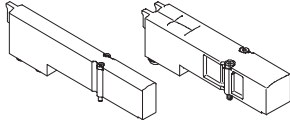

Plate without valve function for reserving valve positions on a valve terminal.

Valves and blanking plates are attached to the manifold block using two screws.

## Valve function

Code	Circuit symbol	Size		Description
		1	2	
L	—	■	■	For valve terminal only: Blanking plate for vacant valve position

## Compressed air supply and venting

### Pneumatic interface

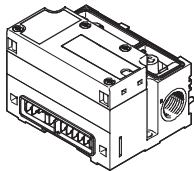

The valve terminal MPA-F can be supplied with air at one or more points. The duct and supply cross sections of the MPA-F are extremely effectively sized. Additional supply plates are not generally required.

The main supply to the valve terminal is located on the pneumatic interface, which links the electrical and the pneumatic parts. Additional provision is made for a number of supply plates. Venting is either via flat plate

silencers or common ports for ducted exhaust. These vents are located on the pneumatic interface as well as on the supply plates. The exhaust air is always vented via port 82/84 on the right-hand end plate.

### Supply plate

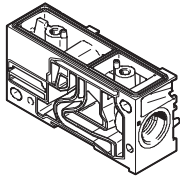

## Pneumatic interface with integrated pressure sensor

The pneumatic interface is available in a version with integrated pressure sensor for duct 1. The display shows

the numerical value for the monitored pressure. The LEDs “psi” and “bar” indicate the pressure value unit. Three

further LEDs indicate whether the applied pressure exceeds, conforms to or falls below the setpoint value. You

can parameterise the pressure sensor via the PLC or the handheld device (CPX-MMI) from Festo.

# Valve terminals type 33 MPA-F

Key features – Pneumatic components

## Compressed air supply and venting

### Work air supply

#### Power supply module with exhaust plate

Exhaust duct 3 and duct 5 separate

Exhaust duct 3/5 common

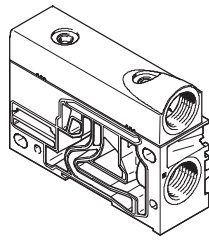
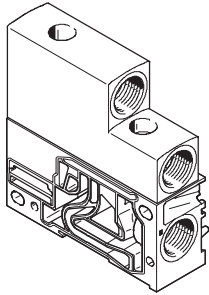

#### Pneumatic interface with left-hand end plate

with venting via flat plate silencer, duct 3/5 common

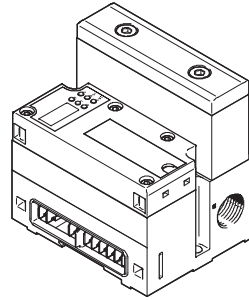

The valve terminal MPA-F can be supplied with pressure at one or more points. This is a reliable way of ensuring that all functional components will always offer good performance, even with large-scale extensions. The valve terminal is supplied via the left-hand end plate or power supply modules. Exhaust port 3/5 is either vented via silencers or ports for ducted exhaust air on the power supply modules and on the left-hand end plate.

## Pilot air supply

The port for the pilot air supply (port 12/14) is always on the right-hand end plate.

The ports differ for the following types of pilot air supply:

- Internal
- External

#### Internal pilot air supply

Internal pilot air supply can be selected if the required working pressure is between 3 and 8 bar. This is done by setting the pilot air supply in the right-hand end plate to this operating mode via a selector switch. The pilot air is branched from port 1 using an internal connection. Port 12/14 must be sealed using a blanking plug.

#### External pilot air supply

If the supply pressure is less than 3 bar or greater than 8 bar, you must operate your MPA-F valve terminal with external pilot air supply. This is done by feeding the pilot air supply via port 12/14 on the right-hand end plate. Port 12/14 is equipped with fittings for this purpose. The selector switch must be set to the appropriate operating mode.



#### Note

If a gradual pressure build-up is required in the system by means of a soft-start valve, then external pilot air should be selected whereby the pilot pressure is already applied at the point of switch-on.

## Right-hand end plate with selector switch

#### Internal pilot air supply

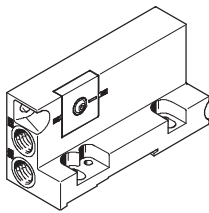

#### External pilot air supply

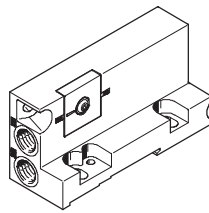

For end plates with selector switch, the outgoing direction of the ports is to the front of the valve terminal. This means that all of the ports on the terminal can be combined in one outgoing direction.

A special feature of the right-hand end plate is the selector switch that

can be set to two different pilot air supply versions.

End plates with selector switch set at the factory for:

- Internal pilot air supply
- External pilot air supply

# Valve terminals type 33 MPA-F

Key features – Pneumatic components

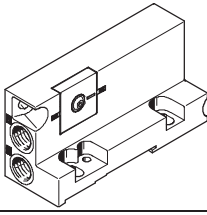
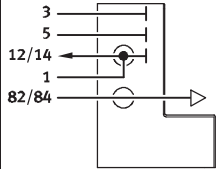
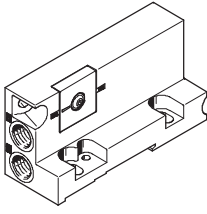
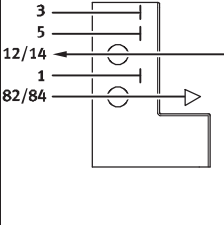
Right-hand end plate					
Code	Type of compressed air supply and pilot air supply	Size		Description	
		1	2		
End plate with selector switch, internal pilot air supply					
S, V, Y			■	■	Internal pilot air supply <ul style="list-style-type: none"> <li>• Pilot air supply is branched internally from port 1</li> <li>• Ports 1 and 12/14 are internally connected</li> <li>• Port 12/14 is sealed with a blanking plug</li> <li>• Pilot exhaust air via port 82/84</li> </ul>
End plate with selector switch, external pilot air supply					
T, X, Z			■	■	External pilot air supply <ul style="list-style-type: none"> <li>• Pilot air supply is connected at port 12/14</li> <li>• Pilot exhaust air via port 82/84</li> </ul>

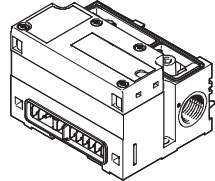
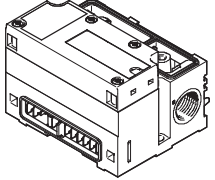
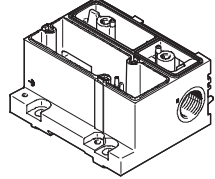
Pneumatic interface with left-hand end plate					
Code	Pneumatic interface design variants		Size		Notes
	Graphical symbol	Type	1	2	
M		VMPAF-FB-EPL VMPAF-FB-EPLM	■	■	<ul style="list-style-type: none"> <li>• Pneumatic interface for CPX plastic interlinking module</li> <li>• Pneumatic interface for CPX metal interlinking module</li> </ul>
MIPE		VMPAF-FB-EPL-PS VMPAF-FB-EPLM-PS	■	■	<ul style="list-style-type: none"> <li>• Pneumatic interface for CPX plastic interlinking module, with integrated pressure sensor for duct 1</li> <li>• Pneumatic interface for CPX metal interlinking module, with integrated pressure sensor for duct 1</li> </ul>
M		VMPAF-MPM-EPL	■	■	<ul style="list-style-type: none"> <li>• Pneumatic interface for multi-pin plug connection</li> </ul>

# Valve terminals type 33 MPA-F

Key features – Pneumatic components

## Pneumatic supply plate (power supply module)

The ducts and supply cross sections of the MPA-F are extremely effectively sized. Additional supply plates are not generally required.  
Supply plates can be configured at any point upstream or downstream of manifold blocks for the creation of pressure zones.

The pilot exhaust port 82/84 is always vented via the right-hand end plate.

Supply plates contain the ports:

- Compressed air supply (1)
- Exhaust air (3/5)

Depending on your order, the exhaust ducts are either ducted or vented via the flat plate silencer.

The supply plate is configured using the code letter U if no directly adjoining separating seal is required.

If a separating seal (S, T or R) is selected directly to the right or left of the supply plate, then the code letter V or W identifies the position of the left-hand or right-hand separating seal. The code for the separating seal (S, T or R) is placed in front of the code for the supply plate (V or W).

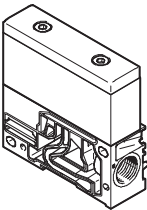
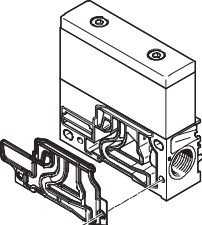
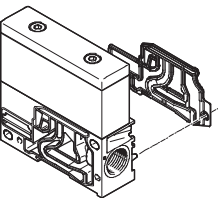
Pneumatic supply plate (power supply module)					
Code <sup>1)</sup>	Graphical symbol	Type	Size		Notes
			1	2	
U		VMPAF-SP-P	■	■	Supply plate without separating seal (no R, S or T selected)
V		VMPAF-SP-P	■	■	Supply plate with separating seal on left, if R, S or T selected
W		VMPAF-SP-P	■	■	Supply plate with separating seal on right, if R, S or T selected

1) The supply plate is equipped with silencer or exhaust plate depending on the code for the air supply S, T, V, X.

# Valve terminals type 33 MPA-F

Key features – Electrical components

## Electrical supply plate

Additional electrical supply plates can be used for larger terminals. This enables up to 64 valve positions/128 solenoid coils to be supplied.

**MPA-F with CPX**  
Electrical supply plates can be configured at any point upstream or downstream of manifold blocks.



Note

Please note that only electrical modules with isolated electrical circuits are permissible to the right of the electrical supply plate. The electrical supply plate must not be installed directly to the left of a pneumatic supply plate (type VMPA-FB-SP-P).

Electrical supply plate					
Code	Graphical symbol	Type	Size		Notes
			1	2	
L		VMPA-FB-SP-V-SP	■	■	Electrical supply plate with M18 plug connection, 3-pin
		VMPA-FB-SP-7/8-V-5POL	■	■	Electrical supply plate with 7/8" plug connection, 5-pin
		VMPA-FB-SP-7/8-V-4POL	■	■	Electrical supply plate with 7/8" plug connection, 4-pin

Pin allocation for power supply		
	Pin	Allocation
Pin allocation for M18		
	2	24 V DC valves
	3	0 VDC
	4	FE
Pin allocation for 7/8", 5-pin		
	1	0 V DC valves
	2	n.c.
	3	FE (leading)
	4	n.c.
	5	24 V DC valves
Pin allocation for 7/8", 4-pin		
	A	n.c.
	B	24 V DC valves
	C	FE
	D	0 V DC valves (leading)

# Valve terminals type 33 MPA-F

Key features – Pneumatic components



## Creating pressure zones and separating exhaust air with separating seals

MPA-F offers a number of options for creating pressure zones if different working pressures are required. Depending on the electrical interface, up to 16 pressure zones are possible. Pressure zones are created by isolating the internal supply ducts between the manifold blocks using an appropriate separating seal.

Compressed air is supplied and vented via a supply plate. The position of the supply plates and separating seals can be freely selected with the valve terminal MPA-F.

Separating seals are integrated ex-works as per your order. Separating seals can be distinguished through their coding, even when the valve terminal is assembled.

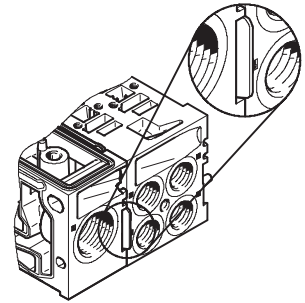

Creating pressure zones					
Code	Separating seal		Size		Notes
	Pictorial examples	Coding	1	2	
-	 VMPAF-DP		■	■	No duct separation
T	 VMPAF-DP-P		■	■	Duct 1 separated
S	 VMPAF-DP-PRS		■	■	Duct 1 and 3/5 separated
R	 VMPAF-DP-RS		■	■	Duct 3/5 separated



# Valve terminals type 33 MPA-F

Key features – Pneumatic components

## Creating pressure zones with duct separation in the manifold block

A pressure zone is created here by isolating the internal supply ducts using a separator that is firmly integrated in the manifold block (code I).

Compressed air is supplied and vented via a supply plate.

Manifold blocks with firmly integrated duct separation can be distinguished by their coding, even when the valve terminal is assembled.

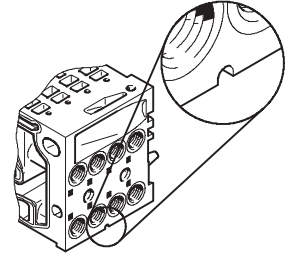

## Creating pressure zones

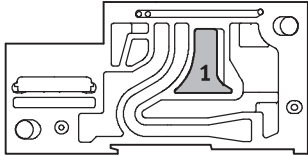
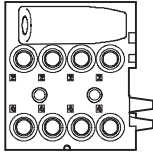
Code	Manifold block with duct separation for operating with flat plate silencer or with ducted exhaust air		Size		Notes
	Pictorial examples	Coding	1	2	
I			■	■	Duct 1 separated

-  - Note

The duct separation cannot be subsequently removed and is integrated in the centre of the manifold block:

- With size 1 between valves 2 and 3
- With size 2 between valves 1 and 2

# Valve terminals type 33 MPA-F

Key features – Pneumatic components



## Examples: Compressed air supply and pilot air supply

### Internal pilot air supply, flat plate silencer

Air supply to the valve terminal:  
code S

The diagram opposite shows an example of the configuration and connection of the air supply with internal pilot air supply. Port 12/14 on the right-hand end plate is sealed with a blanking plug. The selector switch on the right-hand end plate must also be set accordingly. The exhaust port 3/5 is vented via the flat plate silencer. The pilot exhaust port 82/84 is always vented via the right-hand end plate. Separating seals can be used optionally to create pressure zones.

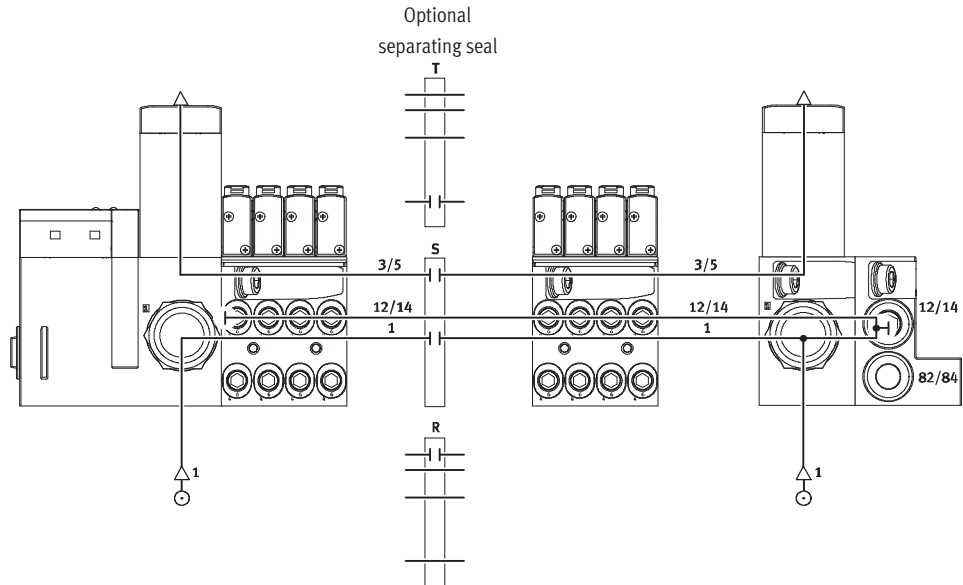

### External pilot air supply, flat plate silencer

Air supply to the valve terminal:  
code T

The diagram opposite shows an example of the configuration and connection of the compressed air supply with external pilot air supply. The external pilot air supply is fed to port 12/14 via the right-hand end plate. The selector switch on the right-hand end plate must also be set accordingly. The exhaust port 3/5 is vented via the flat plate silencer. The pilot exhaust port 82/84 is always vented via the right-hand end plate. Separating seals can be used optionally to create pressure zones.

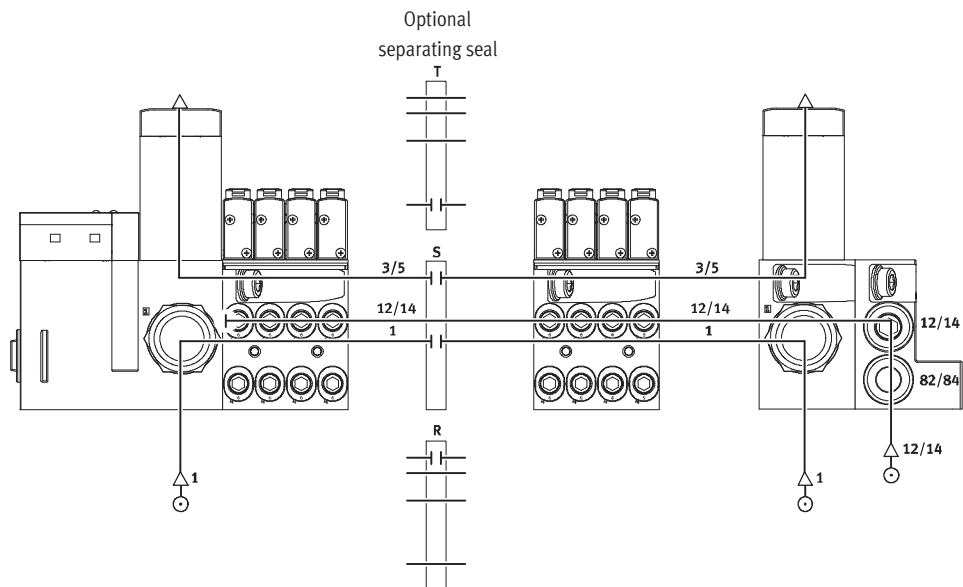

# Valve terminals type 33 MPA-F

Key features – Pneumatic components

## Examples: Compressed air supply and pilot air supply

### Internal pilot air supply, ducted exhaust air

Air supply to the valve terminal:  
code V or Y

The diagram opposite shows an example of the configuration and connection of the compressed air supply with internal pilot air supply. Port 12/14 on the right-hand end plate is sealed with a blanking plug. The selector switch on the right-hand end plate must also be set accordingly. The exhaust port 3/5 is vented via the corresponding ports. The pilot exhaust port 82/84 is always vented via the right-hand end plate. Separating seals can be used optionally to create pressure zones.

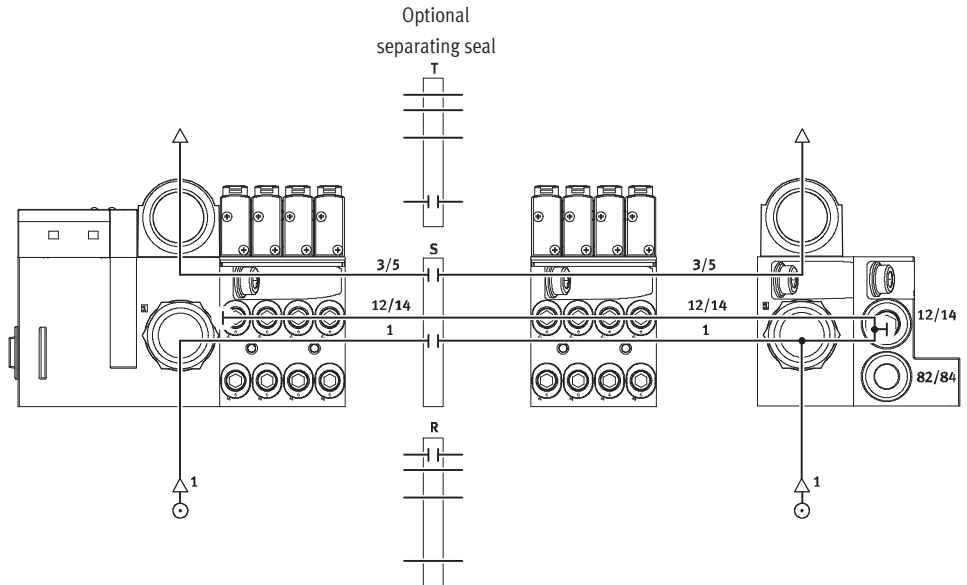

### External pilot air supply, ducted exhaust air

Air supply to the valve terminal:  
code X or Z

The diagram opposite shows an example of the configuration and connection of the compressed air supply with external pilot air supply. The external pilot air supply is fed to port 12/14 via the right-hand end plate. The selector switch on the right-hand end plate must also be set accordingly. The exhaust port 3/5 is vented via the corresponding ports. The pilot exhaust port 82/84 is always vented via the right-hand end plate. Separating seals can be used optionally to create pressure zones.

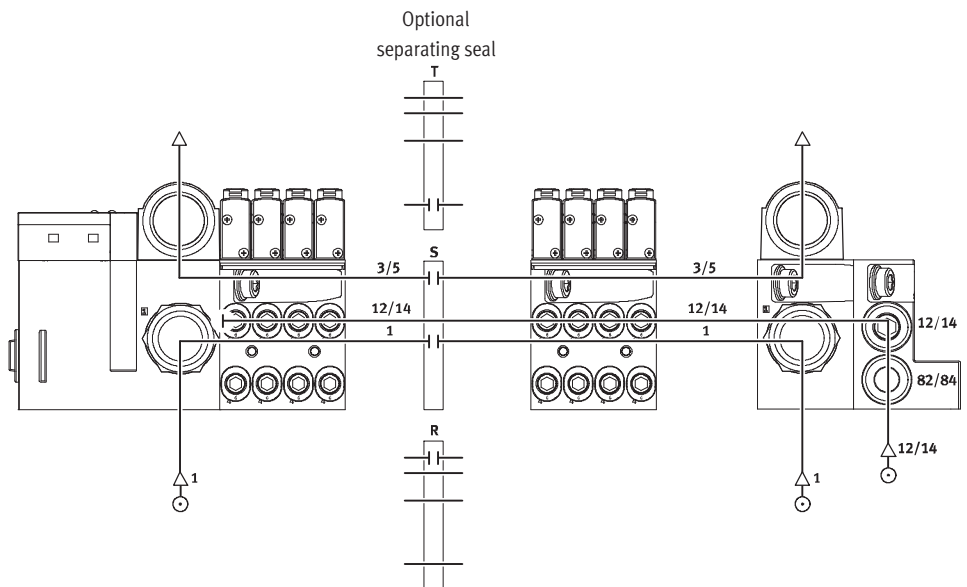

# Valve terminals type 33 MPA-F

Key features – Pneumatic components

## Examples: Creating pressure zones

### Manifold block with pressure zone separation in duct 1

Another way of creating pressure zones is to use manifold blocks with pressure zone separation. The diagram opposite shows the version with pressure zone separation in duct 1.

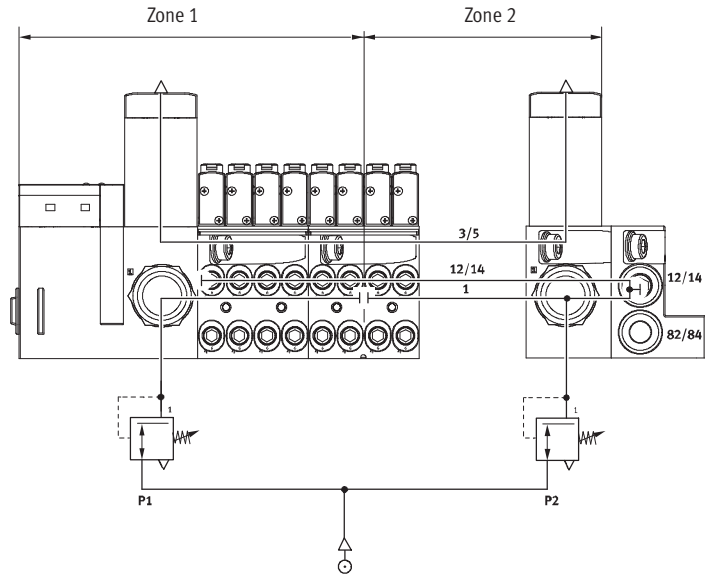

# Valve terminals type 33 MPA-F

Key features – Pneumatic components

## Manifold block

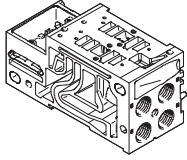

MPA-F is based on a modular system consisting of manifold blocks and valves. The manifold blocks are screwed together and thus form the support system for the valves. They contain the connection ducts for

supplying compressed air to and venting from the valve terminal as well as the working lines for the pneumatic actuators for each valve. Each manifold block is connected to the next using two screws. Individual

terminal sections can be isolated and further manifold blocks inserted by loosening these screws. This ensures that the valve terminal can be rapidly and reliably extended.

Manifold block versions						
Code	Graphical symbol	Type	Size		Number of valve positions (solenoid coils)	Notes
			1	2		
Manifold block for multi-pin plug/fieldbus connection						
A, C*		VMPAF-AP-4-1	■	-	4 (8)	Working ports (2, 4) on the manifold block <ul style="list-style-type: none"> <li>• Connection sizes: MPAF1: M7, QS4, QS6</li> <li>• Code I: Separation in duct 1 in the manifold block</li> </ul>
AI, CI*		VMPAF-AP-4-1-T1				
B, D*		VMPAF-AP-2-2	-	■	2 (4)	Working ports (2, 4) on the manifold block <ul style="list-style-type: none"> <li>• Connection sizes MPAF2: G1/4, QS8, QS10</li> <li>• Code I: Separation in duct 1 in the manifold block</li> </ul>
BI, DI*		VMPAF-AP-2-2-TO				

\* Only possible with multi-pin plug connection

# Valve terminals type 33 MPA-F

Key features – Pneumatic components



## Pressure sensor

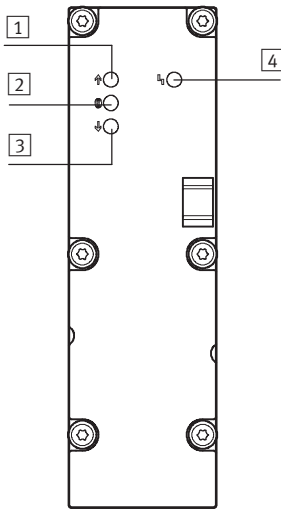

- 1 Red LED: Pressure exceeded
- 2 Green LED: Pressure conforms to
- 3 Red LED: Pressure fallen below
- 4 Red LED: Common error display

The pressure sensor indicates whether the applied pressure exceeds, conforms to or falls below the setpoint value using three LEDs. An additional LED indicates common errors (limit exceeded or fallen below). The limits for pressure monitoring are set by means of parameter settings. You can parameterise the pressure sensor plate via the PLC or the handheld device (CPX-MMI-1) from Festo.

The pressure in the exhaust ducts (3/5) and the process pressure (external) can also be measured. Pressure measurement in the exhaust ducts is used for monitoring the operating pressure during reversible operation (supply to 3/5).

## Pressure sensor versions

Code	Graphical symbol	Type	Use
PE		VMPAF-FB-PS-1	Monitoring the operating pressure in duct 1
PF		VMPAF-FB-PS-3/5	Monitoring the pressure in exhaust ducts 3 and 5 (pressure monitoring for reversible valve terminal)
PG		VMPAF-FB-PS-P1	Monitoring an external process pressure

## Left-hand end plate with integrated pressure sensor

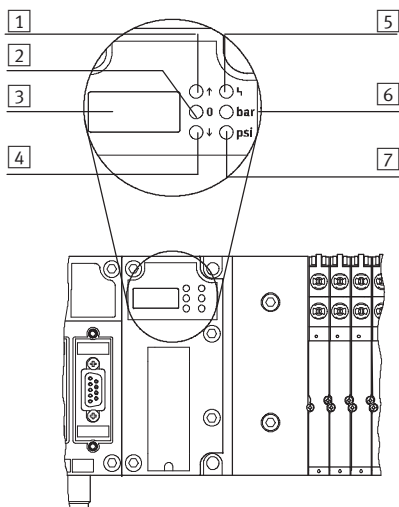

- 1 Red LED: Upper limit exceeded
- 2 Green LED: Pressure in nominal range
- 3 Display
- 4 Red LED: Limit not reached
- 5 Red LED: Common error display
- 6 Yellow LED: Value in display shown in bar
- 7 Yellow LED: Value in display shown in psi

The left-hand end plate with pneumatic interface can be equipped with an integrated pressure sensor. The pressure sensor measures the operating pressure in duct 1. The measured value is displayed numerically and sent to the master controller via the CPX bus node by means of serial linking. This ensures that the system part in question is always operated above a required minimum pressure, but not in the range of excess pressures, which can impair operation.

# Valve terminals type 33 MPA-F

Key features – Pneumatic components

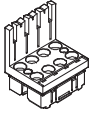
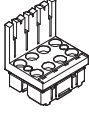
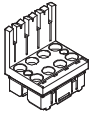
Electrical interface versions						
Code	Graphical symbol	Type	Size		Number of valve positions (solenoid coils)	Notes
			1	2		
Electronics module for multi-pin plug						
A, B, C, D		VMPA1-MPM-EMM-8 VMPA1-MPM-EMM-4	■	-	4 (8) 4 (4)	Each solenoid coil must be assigned to a specific pin of the multi-pin plug in order for the valve to be actuated. Regardless of the blanking plates or valves used, valve positions occupy <ul style="list-style-type: none"> <li>• 1 address for actuation of 1 coil</li> <li>• 2 addresses for actuation of 2 coils</li> </ul>
		VMPA2-MPM-EMM-4 VMPA2-MPM-EMM-2	-	■	2 (4) 2 (2)	
Electronics module for fieldbus with standard diagnostics						
A, B, AH, BH		VMPA...-FB-EMS-... VMPA...-FB-EMG-...	■	-	4 (8)	The electronics module contains the serial communication system and facilitates: <ul style="list-style-type: none"> <li>• Transmission of switching information</li> <li>• Actuation of up to 8 solenoid coils</li> <li>• Position-based diagnostics</li> <li>• Separate voltage supply for valves</li> <li>• Transmission of status, parameter and diagnostic data</li> </ul> There are different versions: <ul style="list-style-type: none"> <li>• Without isolated electrical circuit (VMPA...-FB-EMS-...)</li> <li>• With isolated electrical circuit (VMPA...-FB-EMG-...)</li> </ul> Diagnostic function: <ul style="list-style-type: none"> <li>• Error: Load voltage of the valves</li> </ul>
			-	■	2 (4)	
Electronics module for fieldbus with extended diagnostic function						
A, B, AH, BH with: D2		VMPA...-FB-EMS-...-D2 VMPA...-FB-EMG-...-D2	■	-	4 (8)	The electronics module with extended diagnostic function contains the same functions as the electronics module with standard diagnostics. The diagnostic function, however, has been extended: <ul style="list-style-type: none"> <li>• Error: Load voltage of the valves</li> <li>• Error: Wire break (open load)</li> <li>• Error: Short circuit in load voltage of valves</li> <li>• Message: Condition monitoring</li> </ul>
			-	■	2 (4)	

-  Note

- Multi-pin plug with modular linking
- Manifold blocks MPAF1 and MPAF2 can be combined as required
- Positive or negative switching actuation is possible (mixed operation is not permitted)
- Double solenoid valves cannot be mounted on single solenoid electronics modules
- Single solenoid valves can be mounted on double solenoid electronics modules

# Valve terminals type 33 MPA-F

Key features – Pneumatic components

FESTO

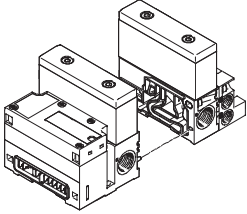
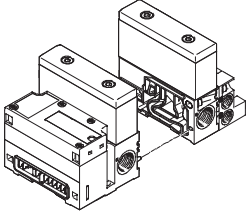
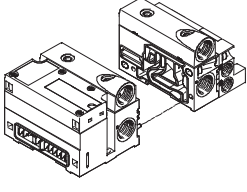
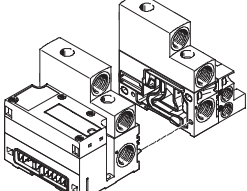
Ports for supply and exhaust							
Code		Connection	Designation	Plug connector, large	Plug connector, small	Code D Thread for supply	
S		Internal pilot air supply, silencer					
		1	Supply air/ vacuum supply	Push-in fitting	QS-G $\frac{1}{2}$ -16-l	QS-G $\frac{1}{2}$ -12-l	G $\frac{1}{2}$
		3/5	Exhaust air	Flat plate silencer	–	–	–
		12/14	Pilot air supply	–	–	–	–
		82/84	Pilot exhaust air	Push-in fitting	QS-G $\frac{1}{4}$ -10-l	QS-G $\frac{1}{4}$ -8-l	G $\frac{1}{4}$
	Silencer	–		–	G $\frac{1}{4}$		
T		External pilot air supply, silencer					
		1	Supply air/ vacuum supply	Push-in fitting	QS-G $\frac{1}{2}$ -16-l	QS-G $\frac{1}{2}$ -12-l	G $\frac{1}{2}$
		3/5	Exhaust air	Flat plate silencer	–	–	–
		12/14	Pilot air supply	Push-in fitting	QS-G $\frac{1}{4}$ -10-l	QS-G $\frac{1}{4}$ -8-l	G $\frac{1}{4}$
		82/84	Pilot exhaust air	Push-in fitting	QS-G $\frac{1}{4}$ -10-l	QS-G $\frac{1}{4}$ -8-l	G $\frac{1}{4}$
	Silencer	–		–	G $\frac{1}{4}$		
V, Y		Internal pilot air supply, ducted exhaust air					
		1	Supply air/ vacuum supply	Push-in fitting	QS-G $\frac{1}{2}$ -16-l	QS-G $\frac{1}{2}$ -12-l	G $\frac{1}{2}$
		3/5	Exhaust air	Push-in fitting	QS-G $\frac{1}{2}$ -16-l	QS-G $\frac{1}{2}$ -12-l	G $\frac{1}{2}$
		12/14	Pilot air supply	–	–	–	–
	82/84	Pilot exhaust air	Push-in fitting	QS-G $\frac{1}{4}$ -10-l	QS-G $\frac{1}{4}$ -8-l	G $\frac{1}{4}$	
X, Z		External pilot air supply, ducted exhaust air					
		1	Supply air/ vacuum supply	Push-in fitting	QS-G $\frac{1}{2}$ -16-l	QS-G $\frac{1}{2}$ -12-l	G $\frac{1}{2}$
		3/5	Exhaust air	Push-in fitting	QS-G $\frac{1}{2}$ -16-l	QS-G $\frac{1}{2}$ -12-l	G $\frac{1}{2}$
		12/14	Pilot air supply	Push-in fitting	QS-G $\frac{1}{4}$ -10-l	QS-G $\frac{1}{4}$ -8-l	G $\frac{1}{4}$
		82/84	Pilot exhaust air	Push-in fitting	QS-G $\frac{1}{4}$ -10-l	QS-G $\frac{1}{4}$ -8-l	G $\frac{1}{4}$
	Silencer	–		–	G $\frac{1}{4}$		



# Valve terminals type 33 MPA-F

Key features – Assembly

## Valve terminal assembly

Sturdy terminal mounting thanks to:

- Four through-holes for wall mounting
- Additional mounting brackets
- H-rail mounting



Note

When wall-mounting MPA-F valve terminals with more than 4 manifold blocks, use additional mounting brackets of the type VMPA-BG-RW to

prevent damage to the valve terminal. The mounting brackets can be mounted on the pneumatic supply plates.

## Wall mounting – Multi-pin plug connection

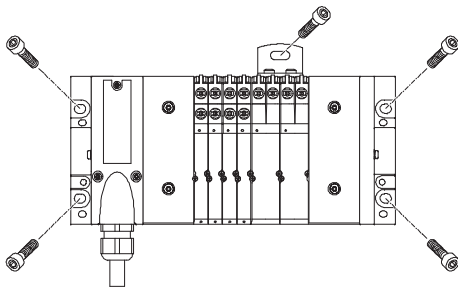

The MPA-F valve terminal is screwed onto the mounting surface using four M6 screws. The mounting holes are on the pneumatic interface and on the right-hand end plate.

Optional mounting brackets are also available.

## Wall mounting – Fieldbus connection

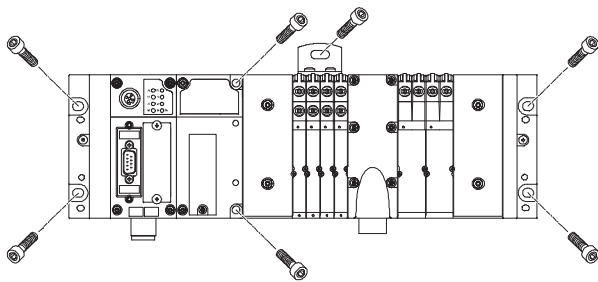

The MPA-F valve terminal is screwed onto the mounting surface using six M6 screws. The mounting holes are on the left-hand end plate (CPX) and on the right-hand end plate (MPA-F).

The pneumatic interface also provides further mounting holes as well as optional mounting brackets.

## H-rail mounting

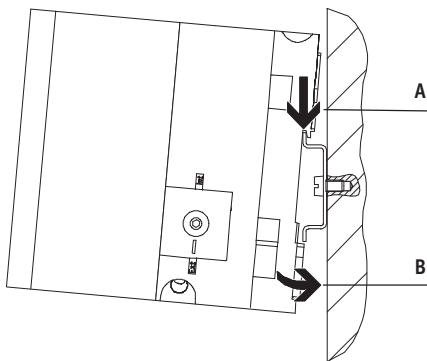

The MPA-F valve terminal is attached to the H-rail (see arrow A).

The valve terminal MPA-F is then swivelled onto the H-rail and secured in place with the clamping components (see arrow B).

For H-rail mounting of the valve terminal you will need the following MPA-F mounting kit:

- With multi-pin plug: CPA-BG-NRH
- With fieldbus: VMPAF-FB-BG-NRH

This enables mounting of the valve terminal on a H-rail to EN 60715.

# Valve terminals type 33 MPA-F

Key features – Display and operation

## Display and operation

Each solenoid coil is allocated an LED that indicates its signal status.

- Indicator 12 shows the signal status of the coil for output 2
- Indicator 14 shows the signal status of the coil for output 4

### Manual override

The manual override (MO) enables the valve to be actuated when not electrically activated or energised. The valve is switched by pushing the manual override. The set switching status can also be locked by turning

the manual override (code R or as accessory).

Alternatives:

- A cover (code N or as accessory) can be fitted over the manual override to prevent it from being locked.

The manual override can then only be activated by pushing it.

- A cover (code V) can be fitted over the manual override to prevent it from being accidentally activated.

## Pneumatic connection and control elements

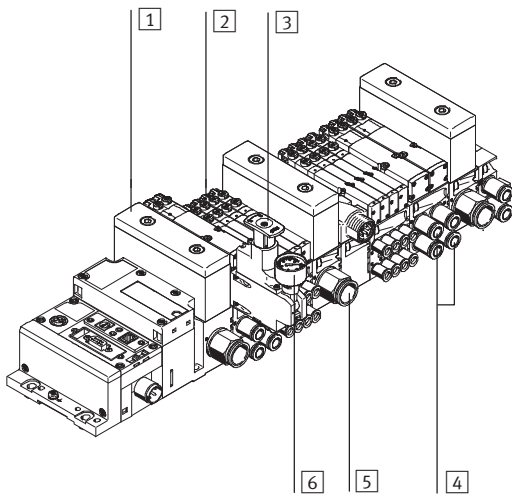

- 1 Flat plate silencer for exhaust port 3/5
- 2 Manual override (for each pilot solenoid coil, non-detenting or non-detenting/detenting)
- 3 Adjusting knob for optional pressure regulator plate
- 4 Working ports 2 and 4, for each valve position
- 5 Supply port 1
- 6 Pressure gauge (optional)

- - Note

A manually actuated valve (manual override) cannot be reset electrically. Conversely, an electrically actuated valve cannot be reset using the mechanical manual override.

## Electrical connection and display components for fieldbus

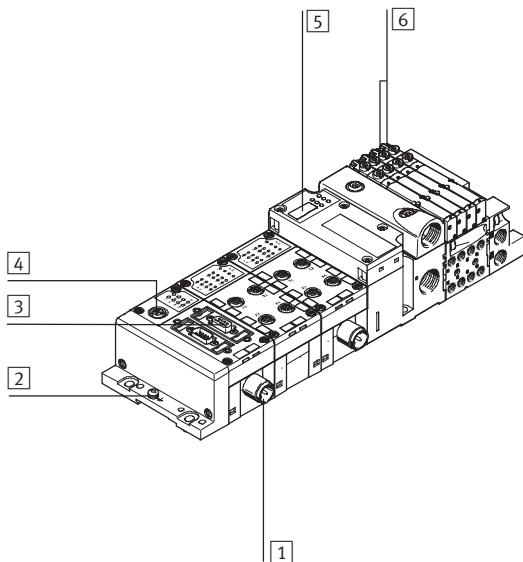

- 1 Power supply connection
- 2 Earthing screw
- 3 Fieldbus connection (bus-specific)
- 4 Service interface for handheld unit, etc.
- 5 Pneumatic interface with optional integrated pressure sensor
- 6 Diagnostic LEDs for valves

# Valve terminals type 33 MPA-F

Key features – Display and operation

## Manual override (MO)

### MO with automatic return (non-detenting)

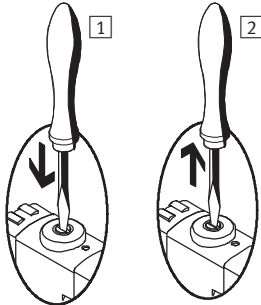

- 1 Press in the stem of the MO with a pin or screwdriver. Pilot valve switches and actuates the main valve.
- 2 Remove the pin or screwdriver. Spring force pushes the stem of the MO back. Pilot valve returns to the initial position and so too the single solenoid main valve (not with double solenoid valve code J).

### MO set via turning (detenting)

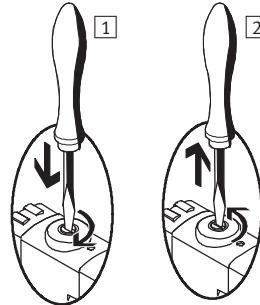

- 1 Press in the stem of the MO with a pin or screwdriver until the valve switches and then turn the stem clockwise by 90° until the stop is reached. Valve remains switched.
- 2 Turn the stem anti-clockwise by 90° until the stop is reached and then remove the pin or screwdriver. Spring force pushes the stem of the MO back. Valve returns to initial position (not with double solenoid valve code J).

## Identification system

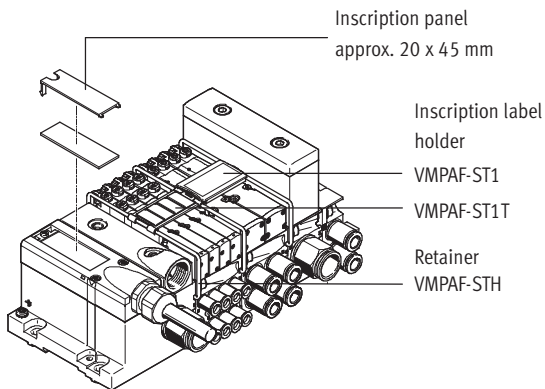

An inscription label holder VMPAF-ST1 (Part No. 546 228, code T in the order code, for holding paper labels) or VMPAF-ST1T (Part No. 544 422, for holding IBS-9x20 inscription labels) can be mounted on each manifold rail for labelling the valves.

Large inscription labels (20 x 45 mm) can be attached to the pneumatic interface as an alternative or in addition to the smaller labels. Inscription label holders can be applied on different sides using circular clips in order to identify pneumatic threaded connectors, solenoid coils or manual override tools, for example.

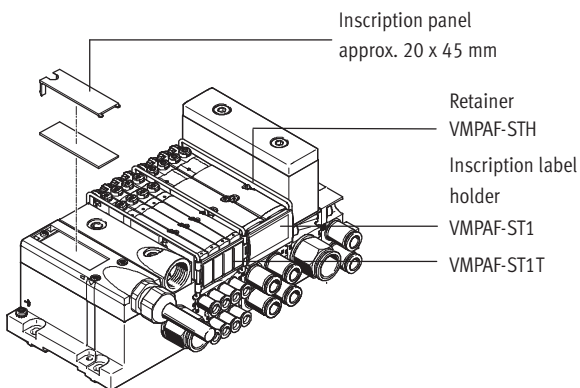

# Valve terminals type 33 MPA-F

Key features – Electrical components

## Electrical power as a result of current reduction

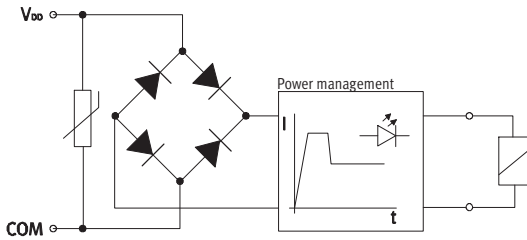

Each MPA solenoid coil is protected with a spark arresting protective circuit as well as against polarity reversal. All valve types are additionally equipped with integrated current reduction.

MPA valves are supplied with operating voltage in the range 18 ... 30 V (24 V +/-25%). This high tolerance is made possible through integrated control electronics and offers additional security, e.g. if the operating voltage drops.

## Individual valve

Valves can also be used on individual sub-bases for actuators further away from the valve terminal.

- Detachable electronics module with integrated holding current reduction
- Electrical M8 connection, 4-pin with screw connection

## Electrical multi-pin plug connection

The following multi-pin plug connection is offered for the valve terminal MPA-F:

- Sub-D multi-pin plug connection (25-pin)

Pins 1 ... 24 are used for addresses 1 ... 24 in order. If fewer than 24 addresses are used for the valve terminal, the remaining

pins up to 24 are left free. Pin 25 is reserved for the neutral conductor. The valves are switched by means of positive or negative logic (PNP or NPN). Mixed operation is not permitted. Each pin on the multi-pin plug can actuate exactly one valve solenoid coil. If the maximum configurable number of valve positions is 24,

this means that 24 valves, each with a single solenoid coil, can be addressed. With 12 or fewer valve positions, 2 solenoid coils per valve can be addressed. With 12 or more valve positions, the number of available valve positions for valves with two solenoid coils decreases.

**Note**  
If a single solenoid valve is assembled on a double solenoid valve position, the second address is also occupied and cannot be used.

## CPX fieldbus connection

All functions and features of the electrical peripherals CPX are permitted in connection with the CPX interface. This means:

- The valves and electrical outputs are supplied via the operating voltage connection CPX
- The valves are supplied and disconnected separately via a separate valve connection on the CPX (code V)



**Note**  
Further information can be found on:  
➔ Internet: cpx

## Guidelines on addressing for valves/solenoid coils

- The maximum possible number of addresses with a multi-pin plug connection is 24
- Each manifold block/electronics module occupies a defined number of addresses/pins:
  - Manifold rail MPAF1 for 4 single solenoid valves: 4
  - Manifold rail MPAF2 for 2 double solenoid valves: 2
  - Manifold rail MPAF2 for 2 double solenoid valves: 4
- The numbering of the addresses goes from left to right in ascending consecutive order. The following applies to the individual valve positions: address x for coil 14 and address x+1 for coil 12
- If single solenoid valves are mounted on manifold blocks for double solenoid valves, the address of coil 12 and the assigned pin will remain unused

# Valve terminals type 33 MPA-F

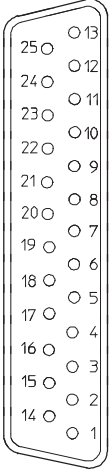
Key features – Electrical components

Pin allocation – Sub-D socket, cable								
	Pin	Address/coil	Wire colour <sup>2)</sup>		Pin	Address/coil	Wire colour <sup>2)</sup>	
	1	0	WH		17	16	WH PK	
	2	1	GN		18	17	PK BN	
	3	2	YE		19	18	WH BU	
	4	3	GY		20	19	BN BU	
	5	4	PK		21	20	WH RD	
	6	5	BU		22	21	BN RD	
	7	6	RD		23	22	WH BK	
	8	7	VT		24	23	BN	
	9	8	GY PK	25	0 V <sup>1)</sup>	BK		
	10	9	RD BU	 Note The drawing shows a view on the Sub-D socket on the multi-pin cable VMPA-KMS1-....				
	11	10	WH GN					
	12	11	BN GN					
	13	12	WH YE					
	14	13	YE BN					
	15	14	WH GY					
	16	15	GY BN					

1) 0 V for positive switching control signals; connect 24 V for negative switching control signals; mixed operation is not permitted.  
 2) To IEC 757

### Dimensions

Download CAD data → [www.festo.com](http://www.festo.com)

Connecting cables

1 Cable connector with clamping range 6 ... 12 mm

The wire colours refer to the following pre-assembled multi-pin cables from Festo:

- VMPA-KMS1-8-... Valve terminal for up to 4 valve positions (8 coils)
- VMPA-KMS1-24-... Valve terminal with 8 ... 24 valve positions

Type	Sheath	Length [m]	Wire x mm <sup>2</sup>	D [mm]	Part No.
VMPA-KMS1-8-2.5	PVC	2.5	10 x 0.34	6.9	533195
VMPA-KMS2-8-2.5-PUR	PUR	2.5	10 x 0.25	8.3	533504
VMPA-KMS1-8-5	PVC	5	10 x 0.34	6.9	533196
VMPA-KMS2-8-5-PUR	PUR	5	10 x 0.25	8.3	533505
VMPA-KMS1-8-10	PVC	10	10 x 0.34	6.9	533197
VMPA-KMS2-8-10-PUR	PUR	10	10 x 0.25	8.3	533506
VMPA-KMS1-24-2.5	PVC	2.5	25 x 0.34	11.4	533192
VMPA-KMS2-24-2.5-PUR	PUR	2.5	25 x 0.25	11.2	533501
VMPA-KMS1-24-5	PVC	5	25 x 0.34	11.4	533193
VMPA-KMS2-24-5-PUR	PUR	5	25 x 0.25	11.2	533502
VMPA-KMS1-24-10	PVC	10	25 x 0.34	11.4	533194
VMPA-KMS2-24-10-PUR	PUR	10	25 x 0.25	11.2	533503
VMPA-KMS-H	Cover for self-assembly				533198

# Valve terminals type 33 MPA-F

Key features – Electrical components



FESTO

Instructions for use		
System equipment	Bio-oils	Mineral oils
<p>Operate system equipment with unlubricated compressed air if possible. Festo valves and cylinders are designed so that, if used as designated, they will not require additional lubrication and will still achieve a long service life.</p> <p>The quality of compressed air downstream from the compressor must correspond to that of unlubricated compressed air. If possible, do not operate all of your system equipment with lubricated compressed air. The lubricators should, where possible, always be installed directly upstream of the actuator used.</p>	<p>Unsuitable additional oil and an excessive oil content in the compressed air reduce the service life of the valve terminal.</p> <p>Use Festo special oil OFSW-33 or the alternatives listed in the Festo catalogue (as specified in DIN 51524 HLP32; basic oil viscosity 32 CST at 40 °C).</p>	<p>When using mineral oils (e.g. HLP oils to DIN 51524, parts 1 through 3) or similar oils based on poly-alpha-olefins (PAO), the maximum residual oil content of 5 mg/m<sup>3</sup> must not be exceeded (see ISO 8573-1 Class 4). A higher residual oil content irrespective of the compressor oil cannot be permitted, as the basic lubricant would be flushed out over time.</p>

## Valve terminals type 33 MPA-F

FESTO

Technical data

-  - Flow rate  
MPAF1: Up to 360 l/min  
MPAF2: Up to 900 l/min
-  - Valve width  
MPAF1: 10 mm  
MPAF2: 21 mm
-  - Voltage  
24 V DC

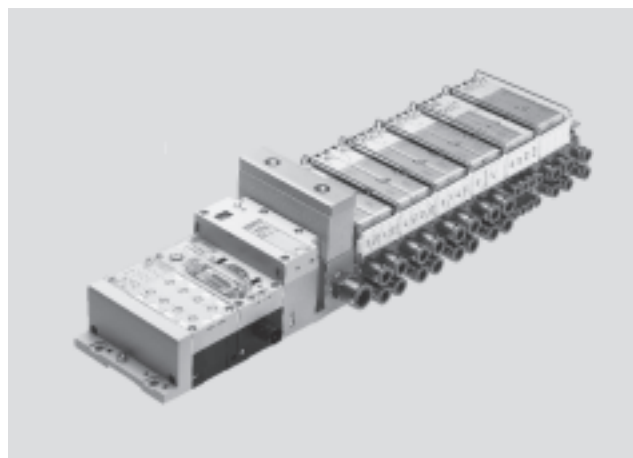

General technical data		
	MPAF1	MPAF2
Constructional design	Electromagnetically actuated piston spool valve	
Lubrication	Lubricated for life, PWIS-free (free of paint-wetting impairment substances)	
Type of mounting	Wall mounting On H-rail to EN 60715	
Mounting position	Any	
Manual override	Non-detenting, detenting, blocked	
Width [mm]	10.5	21
Pneumatic connections		
Pneumatic connection	Via manifold block	
Supply port	1	QS-G $\frac{1}{2}$ -12, QS-G $\frac{1}{2}$ -16
Exhaust port	3/5	Via flat plate silencer or exhaust plate
Working ports	2/4	Depending on the connection type selected
	<ul style="list-style-type: none"> <li>• QSM-M7-6-I</li> <li>• QSM-M7-4-I</li> </ul>	<ul style="list-style-type: none"> <li>• QS-G<math>\frac{1}{4}</math>-8-I</li> <li>• QSG<math>\frac{1}{4}</math>-10-I</li> </ul>
Pilot air port	12/14	QS-G $\frac{1}{4}$ -8-I, QS-G $\frac{1}{4}$ -10-I
Pilot exhaust air port	82/84	QS-G $\frac{1}{4}$ -8-I, QS-G $\frac{1}{4}$ -10-I

# Valve terminals type 33 MPA-F

Technical data

Operating and environmental conditions		M	J	N	K	H	B	G	E	X	W	D	I	NS	KS	HS	DS
Valve function order code																	
Operating medium		Filtered compressed air, lubricated or unlubricated, inert gases → 38															
Grade of filtration	[μm]	40															
Operating pressure with external pilot air supply	[bar]	-0.9 ... +10			3 ... 10			-0.9 ... +10			3 ... 10			-0.9 ... +8			
Operating pressure for valve terminal with internal pilot air supply	[bar]	3 ... 8															
Pilot pressure	[bar]	3 ... 8															
Ambient temperature	[°C]	-5 ... +50															
Temperature of medium	[°C]	-5 ... +50															
Storage temperature <sup>1)</sup>	[°C]	-20 ... +40															
Relative air humidity at 40° C	[%]	90															

1) Long-term storage

## Pilot pressure p2 as a function of working pressure p1 with external pilot air supply for valves with code M, J, B, G, E, X, W

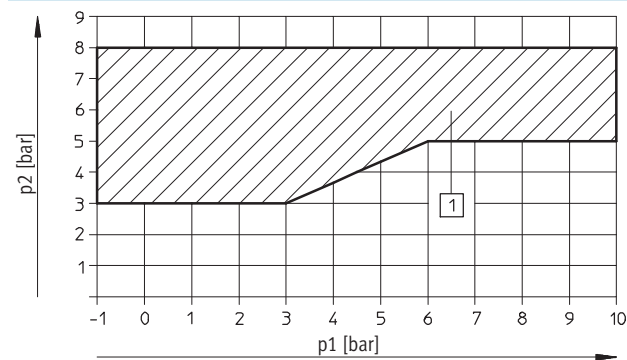

1) Operating range for valves with external pilot air supply

## for valves with code N, K, H, D, I

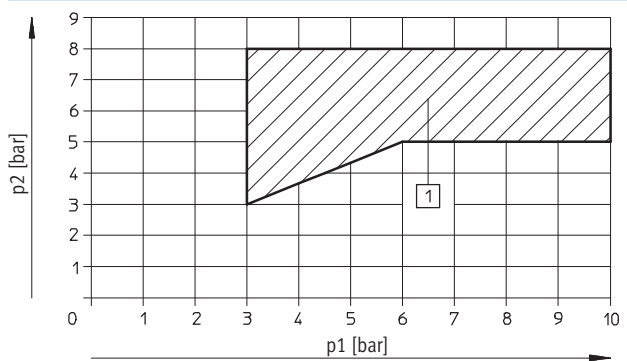

1) Operating range for valves with external pilot air supply



# Valve terminals type 33 MPA-F

Technical data

## Pilot pressure $p_2$ as a function of working pressure $p_1$ for valves with mechanical spring return (MPA1)

For valves with code NS, KS, HS, DS

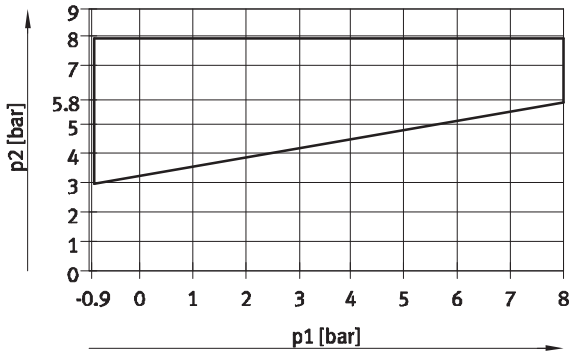

## Flow rate $q_n$ as a function of output pressure $p_2$ with pressure regulator plates (P regulator plate) for port 1

Width 21 mm

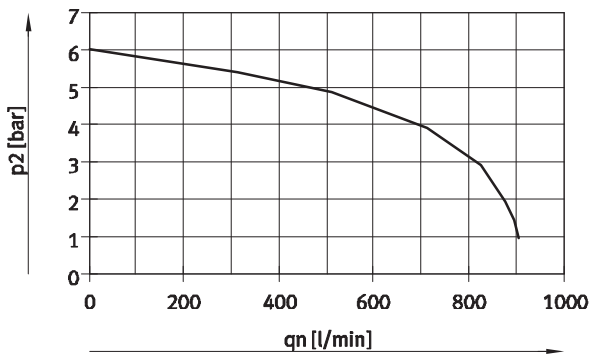

Supply pressure 10 bar,  
set regulator pressure 6 bar

## Flow rate $q_n$ as a function of output pressure $p_2$ with pressure regulator plates (B regulator plates) for port 2

Width 21 mm

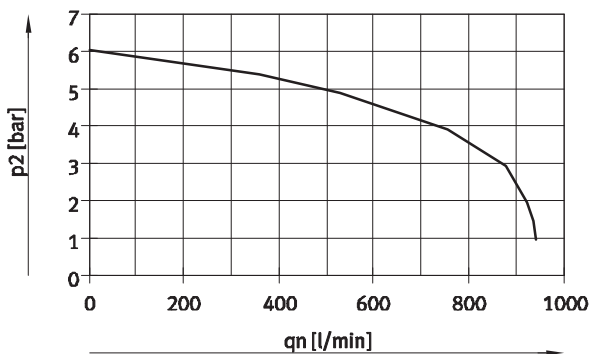

Supply pressure 10 bar,  
set regulator pressure 6 bar

# Valve terminals type 33 MPA-F

Technical data

FESTO

## Flow rate $q_n$ as a function of output pressure $p_2$ with pressure regulator plates (A regulator plates) for ports 4

Width 21 mm

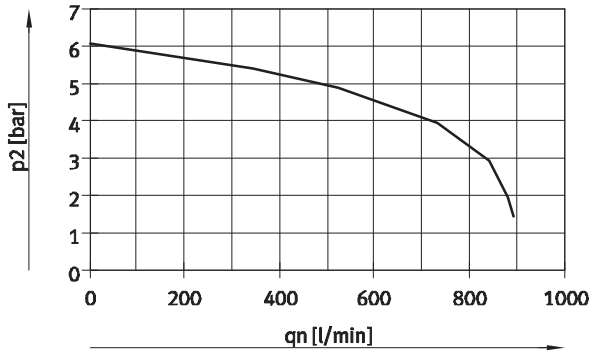

Supply pressure 10 bar,  
set regulator pressure 6 bar

## Flow rate $q_n$ as a function of output pressure $p_2$ with pressure regulator plates (B regulator plates, rev.) for ports 3, reversible

Width 21 mm

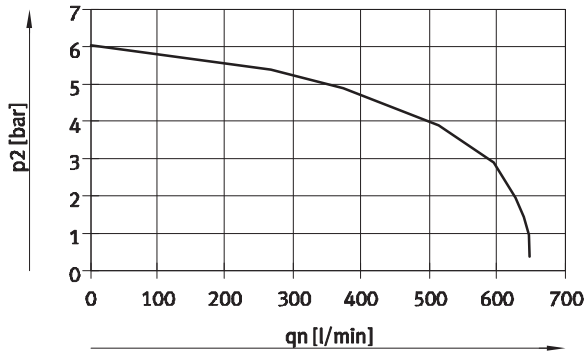

Supply pressure 10 bar,  
set regulator pressure 6 bar

## Flow rate $q_n$ as a function of output pressure $p_2$ with pressure regulator plates (A regulator plates, rev.) for ports 5, reversible

Width 21 mm

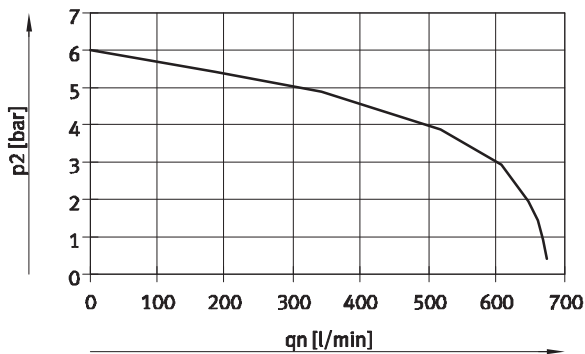

Supply pressure 10 bar,  
set regulator pressure 6 bar

# Valve terminals type 33 MPA-F

Technical data

FESTO

Certifications <sup>1)</sup>		
Type	MPAF-MPM-VI (VI with multi-pin connection)	MPAF-FB-VI (VI with fieldbus connection)
Part No.	544398	544397
ATEX category gas	II 3 G	–
Ex-ignition protection type gas	Ex nA II T4 X	–
ATEX category dust	II 3D	–
EX-ignition protection type dust	Ex tD A22 IP54 T95°C X	–
ATEX ambient temperature [°C]	–5 ≤ Ta ≤ +50	–
Certification	c UL us - Recognized (OL)	

1) Unlisted interface variants (e.g. CPI interface or AS interface) do not include the listed certifications.

Nominal flow rate [l/min] <sup>1)</sup>			
Code	Valve function	With fitting	
		From port 1 to 2, or 1 to 4	From port 2 to 3/5, or 4 to 3/5
MPA1			
M	5/2-way valve, single solenoid	360	360
J	5/2-way valve, double solenoid	360	360
N	2x 3/2-way valve, normally open	300	300
NS	2x 3/2-way valve, normally open, mechanical spring return	300	300
K	2x 3/2-way valve, normally closed	230	310
KS	2x 3/2-way valve, normally closed, mechanical spring return	230	310
H	2x 3/2-way valve, 1x normally open, 1x normally closed	300	300
HS	2x 3/2-way valve, 1x normally open and 1x normally closed, mechanical spring return	300	305
B	5/3-way valve, mid-position pressurised	300 (220) <sup>2)</sup>	270
G	5/3-way valve, mid-position closed	320	320
E	5/3-way valve, mid-position exhausted	240	240 (200) <sup>2)</sup>
X	1x 3/2-way valve	230	295
W	1x 3/2-way valve	230	295
D	2x 2/2-way valve	255	–
DS	2x 2/2-way valve, mechanical spring return	230	–
I	2x 2/2-way valve	260	260

1) Values also apply to individual sub-bases

2) Value for mid-position

# Valve terminals type 33 MPA-F

Technical data

Nominal flow rate [l/min] <sup>1)</sup>					
Code	Valve function	Without fitting		With fitting <sup>2)</sup>	
		From port 1 to 2, or 1 to 4	From port 2 to 3/5, or 4 to 3/5	From port 1 to 2, or 1 to 4	From port 2 to 3/5, or 4 to 3/5
<b>MPA2</b>					
M	5/2-way valve, single solenoid	900	820	880	800
J	5/2-way valve, double solenoid	900	820	880	800
N	2x 3/2-way valve, normally open	560	490	550	480
K	2x 3/2-way valve, normally closed	580	550	570	540
H	2x 3/2-way valve, 1x normally open, 1x normally closed	560	490	550	480
B	5/3-way valve, mid-position pressurised	520	715 (350) <sup>3)</sup>	510	700 (350) <sup>3)</sup>
G	5/3-way valve, mid-position closed	770	700	750	680
E	5/3-way valve, mid-position exhausted	750	440 (370) <sup>3)</sup>	735	430 (370) <sup>3)</sup>
X	1x 3/2-way valve	500	590	470	580
W	1x 3/2-way valve	600	520	570	510
D	2x 2/2-way valve	840	–	820	–
I	2x 2/2-way valve	840	715	820	700

- 1) Values also apply to individual sub-bases
- 2) Flow rates measured on manifold block with fitting QS-M7-6-1 for MPA1 and QS-G1/8-8-1 for MPA2
- 3) Value for mid-position

Valve switching times [ms]																	
Valve function order code	M	J	N	K	H	B	G	E	X	W	D	I	NS	KS	HS	DS	
<b>MPA1</b>																	
Switching times	on	10	10	10	10	10	10	10	10	10	10	10	10	14	14	14	14
	off	20	–	20	20	20	35	35	35	20	20	20	20	16	16	16	16
	change-over	–	15	–	–	–	–	–	–	–	–	–	–	–	–	–	–
<b>MPA2</b>																	
Switching times	on	15	9	8	8	8	11	10	11	13	13	7	7	–	–	–	–
	off	28	–	28	28	28	46	40	47	22	22	25	25	–	–	–	–
	change-over	–	22	–	–	–	23	21	23	–	–	–	–	–	–	–	–

# Valve terminals type 33 MPA-F

Technical data

FESTO

Electrical data		
MPA-F with electronics module VMPA...-FB... (CPX terminal, CPI interface)		
Voltage supply for electronics ( $V_{EL/SEN}$ )		
Nominal voltage	[V DC]	24
Operating voltage range	[V DC]	18 ... 30
Max. intrinsic current consumption per electronics module at 24 V (regardless of the switching status of the valves)	[mA]	20
Load voltage supply of valves ( $V_{VAL}$ )		
Nominal voltage	[V DC]	24
Operating voltage range	[V DC]	18 ... 30
Maximum intrinsic current consumption at 24 V per electronics module (regardless of the switching status of the valves)		
VMPA1-FB-EMS-8 or VMPA2-FB-EMS-4	[mA]	8 not galvanically isolated (max. signal line length 10 m)
VMPA1-FB-EMG-8 or VMPA2-FB-EMG-4	[mA]	25 galvanically isolated
Diagnostic message undervoltage $V_{VAL}$ Load voltage outside function range	[V]	17.5 ... 15.5
Protection class to EN 60529		IP65 (for all types of signal transmission in assembled state)
Maximum current consumption per solenoid coil at nominal voltage		MPAF1
Nominal pick-up current	[mA]	58
Nominal current with current reduction	[mA]	9
Time until current reduction	[ms]	24
		MPAF2
Nominal pick-up current	[mA]	99
Nominal current with current reduction	[mA]	18
Time until current reduction	[ms]	24
Calculation example		
Current consumption with two solenoid coils MPAF2 switched in parallel and one electronics module without galvanic isolation	[mA]	$I_{EL/SEN} = 20$
Nominal pick-up current	[mA]	$I_{VAL} = 8 + 2 \times 90 = 188$
Nominal current with current reduction	[mA]	$I_{VAL} = 8 + 2 \times 18 = 44$

Electrical data		
MPAF with electronics module VMPA...-MPM (multi-pin plug)		
Voltage supply		
Nominal voltage	[V DC]	24
Operating voltage range	[V DC]	18 ... 30
Residual ripple	[Vss]	4
Current consumption at Sub-D multi-pin plug connection per solenoid coil at nominal voltage		MPAF1
Nominal pick-up current	[mA]	80
Nominal current with current reduction	[mA]	25
Time until current reduction	[ms]	25
		MPAF2
Nominal pick-up current	[mA]	100
Nominal current with current reduction	[mA]	20
Time until current reduction	[ms]	50

# Valve terminals type 33 MPA-F

Technical data

Materials	
Manifold block	Die-cast aluminium
Valve	Die-cast aluminium
Seals	NBR, elastomer
Supply plate	Die-cast aluminium
Right-hand end plate	Die-cast aluminium
Left-hand pneumatic interface	Die-cast aluminium, polyamide
Exhaust plate	Polyamide
Flat plate silencer	Polyethylene
Electrical supply plate	Housing: die-cast aluminium Cover: reinforced polyamide
Electronics module	Polycarbonate
Electrical interlinking module	Bronze/polybutylene terephthalate
Regulator plate	Control section, housing: polyamide; seals: nitrile rubber

Product weight			
Approx. weight	[g]	MPA1	MPA2
Per valve M, X, W		49	100
Per valve J, N, K, H, B, G, E, D		56	100
Per valve KS, NS, HS, DS		56	-
Per vacant position L		24	44
Regulator plate (MPA2)		180	
QSM-M7-4-I		6	
QSM-M7-6-I		5	
QS-G¼-8-I		22	
QS-G¼-10-I		23	
QS-½-12		22	
QS-½-16		13	

# Valve terminals type 33 MPA-F

Technical data

## Dimensions

Download CAD data → [www.festo.com](http://www.festo.com)

Valve terminal with multi-pin plug connection

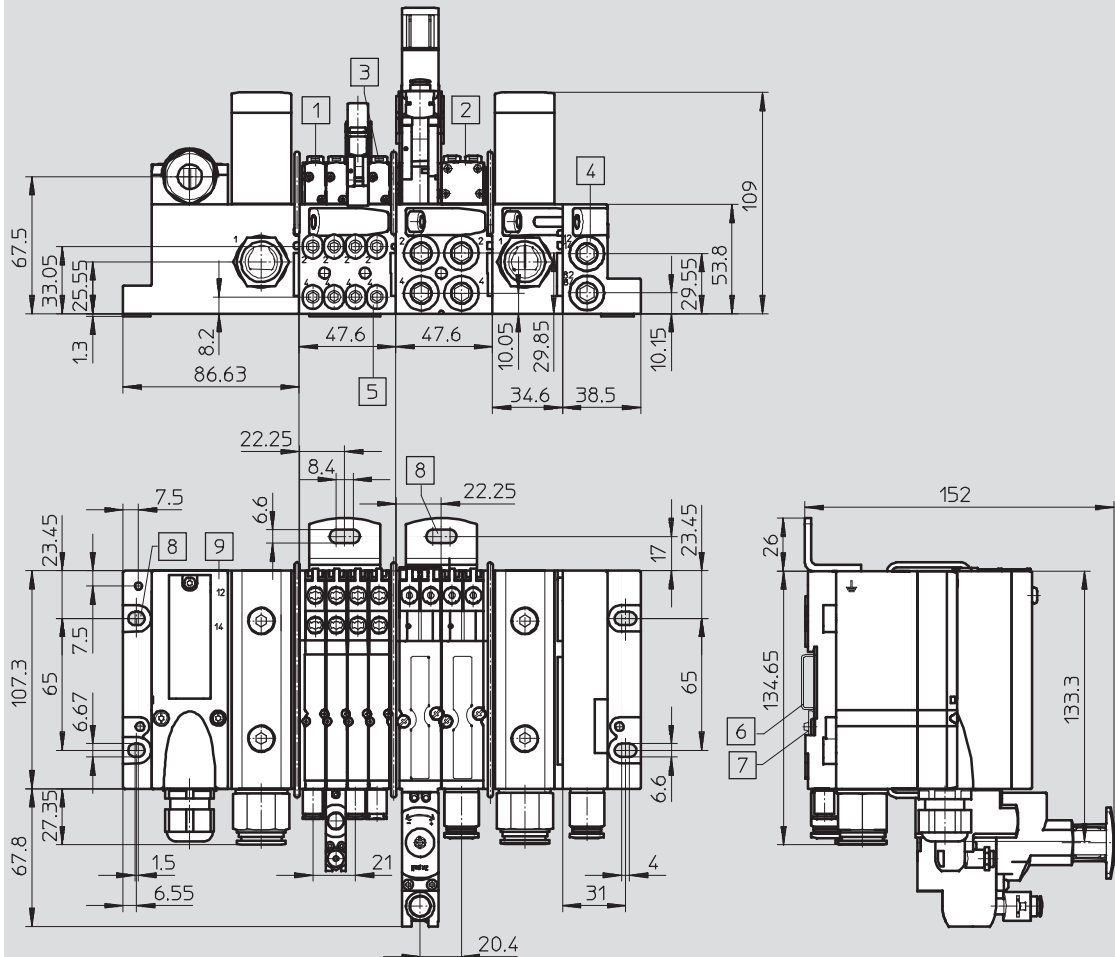

- |                       |                                       |                             |
|-----------------------|---------------------------------------|-----------------------------|
| 1 Solenoid valve MPA1 | 4 Pilot air supply, pilot exhaust air | 7 H-rail mounting           |
| 2 Solenoid valve MPA2 | 5 Working ports                       | 8 Mounting holes            |
| 3 Manual override     | 6 H-rail                              | 9 Multi-pin plug connection |

# Valve terminals type 33 MPA-F

Technical data

FESTO

## Dimensions

Download CAD data → [www.festo.com](http://www.festo.com)

Valve terminal with fieldbus connection

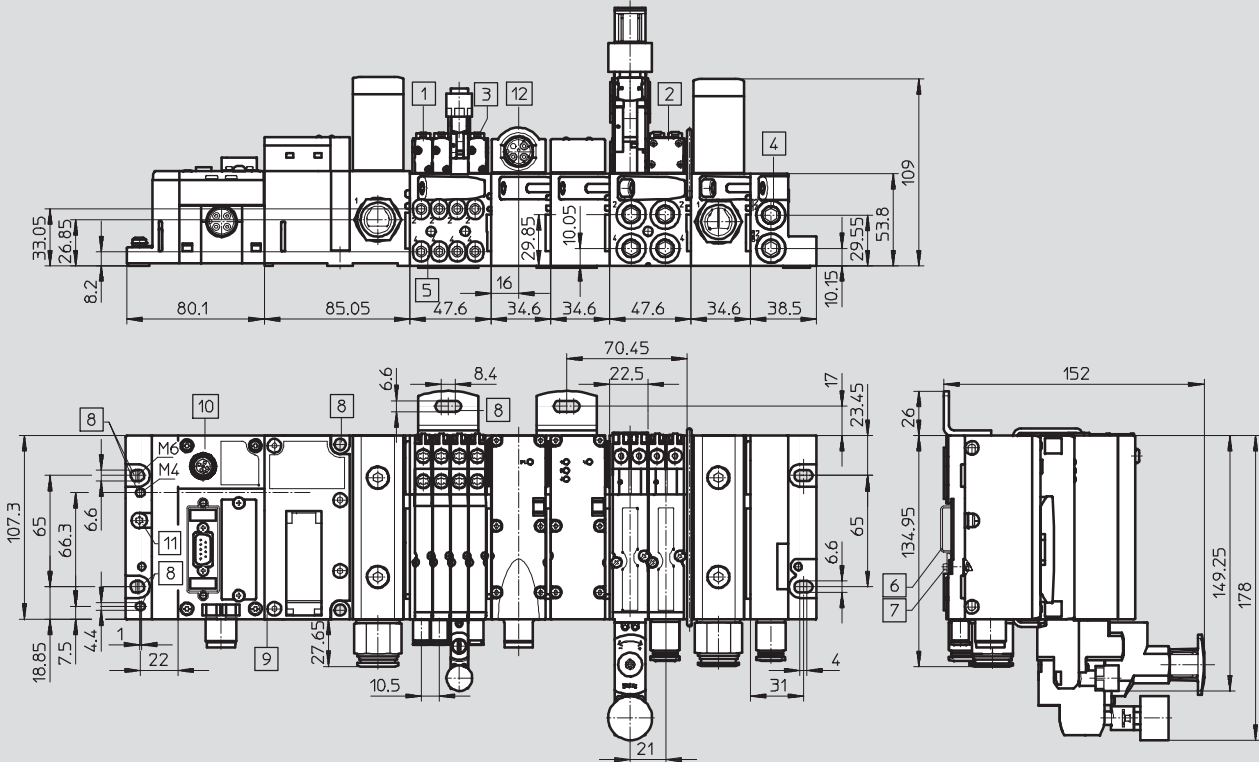









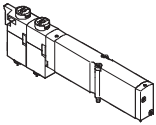
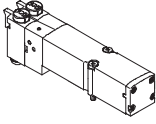

- |                                       |                            |                            |
|---------------------------------------|----------------------------|----------------------------|
| 1 Solenoid valve MPA1                 | 6 H-rail                   | 10 CPX module              |
| 2 Solenoid valve MPA2                 | 7 H-rail mounting          | 11 Earthing screw          |
| 3 Manual override                     | 8 Mounting holes           | 12 Electrical supply plate |
| 4 Pilot air supply, pilot exhaust air | 9 Pneumatic interface MPAF |                            |
| 5 Working ports                       |                            |                            |



# Valve terminals type 33 MPA-F

Accessories



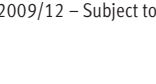

FESTO

Ordering data – Individual sub-base valve				
	Code	Valve function	Part No.	Type
	M	5/2-way valve, single solenoid	533342	VMPA1-M1H-M-PI
			537952	VMPA2-M1H-M-PI
	J	5/2-way valve, double solenoid	533343	VMPA1-M1H-J-PI
			537953	VMPA2-M1H-J-PI
	N	2x 3/2-way valve, normally open	533348	VMPA1-M1H-N-PI
			537958	VMPA2-M1H-N-PI
	NS	2x 3/2-way valve, normally open, mechanical spring return	556839	VMPA1-M1H-NS-PI
			W	1x 3/2-way valve, normally open, external compressed air supply
	K	2x 3/2-way valve, normally closed	533347	VMPA1-M1H-K-PI
			537957	VMPA2-M1H-K-PI
	KS	2x 3/2-way valve, normally closed, mechanical spring return	556838	VMPA1-M1H-KS-PI
			H	2x 3/2-way valve, 1x normally open, 1x normally closed
	HS	2x 3/2-way valve, 1x normally open, 1x normally closed, mechanical spring return	537959	VMPA2-M1H-H-PI
			556840	VMPA1-M1H-HS-PI
	B	5/3-way valve, mid-position pressurised	533344	VMPA1-M1H-B-PI
			537954	VMPA2-M1H-B-PI
	G	5/3-way valve, mid-position closed	533345	VMPA1-M1H-G-PI
			537955	VMPA2-M1H-G-PI
	E	5/3-way valve, mid-position exhausted	533346	VMPA1-M1H-E-PI
			537956	VMPA2-M1H-E-PI
	X	1x 3/2-way valve, normally closed, external compressed air supply	534415	VMPA1-M1H-X-PI
			537961	VMPA2-M1H-X-PI
	D	2x 2/2-way valve, normally closed	533350	VMPA1-M1H-D-PI
			537960	VMPA2-M1H-D-PI
	DS	2x 2/2-way valve, normally closed, mechanical spring return	556841	VMPA1-M1H-DS-PI
			I	2x 2/2-way valve, 1x normally closed, 1x normally closed, reversible
	I	2x 2/2-way valve, 1x normally closed, 1x normally closed, reversible	543703	VMPA2-M1H-I-PI

# Valve terminals type 33 MPA-F

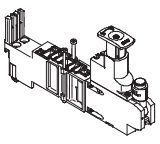
Accessories

**FESTO**

Ordering data					
	Code	Description	Supply pressure 1 [bar]	Part No.	Type
<b>Regulator plate</b>					
	PF	MPA2, port 1	0.5 ... 6	549055	VMPA2-B8-R1C2-C-06
	PA		0.5 ... 10	543342	VMPA2-B8-R1C2-C-10
	PH	MPA2, port 2	0.5 ... 6	549056	VMPA2-B8-R2C2-C-06
	PC		0.5 ... 10	543343	VMPA2-B8-R2C2-C-10
	PN	MPA2, port 2, reversible	0.5 ... 6	549113	VMPA2-B8-R6C2-C-06
	PL		0.5 ... 10	543347	VMPA2-B8-R6C2-C-10
	PG	MPA2, port 4	0.5 ... 6	549057	VMPA2-B8-R3C2-C-06
	PB		0.5 ... 10	543344	VMPA2-B8-R3C2-C-10
	PM	MPA2, port 4, reversible	0.5 ... 6	549114	VMPA2-B8-R7C2-C-06
	PK		0.5 ... 10	543348	VMPA2-B8-R7C2-C-10
<b>Pressure gauge for regulator plate</b>					
	-	With cartridge connection for regulator, 10 bar for regulator plate code PA, PB, PC, PL, PK		543487	PAGN-26-16-P10
	-	With cartridge connection for regulator, 6 bar for regulator plate code PF, PG, PH, PN, PM		543488	PAGN-26-10-P10
<b>Mounting</b>					
	-	For H-rail, MPAF with fieldbus		560798	VMPAF-FB-BG-NRH
	-	For H-rail, MPAF with multi-pin plug connection		173498	CPA-BG-NRH
	-	Mounting bracket		544420	VMPAF-BG-RW

# Valve terminals type 33 MPA-F

Accessories

FESTO

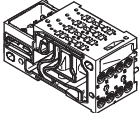
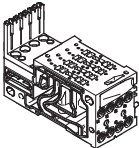
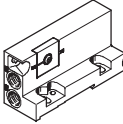
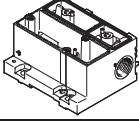
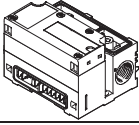
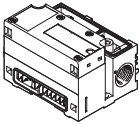
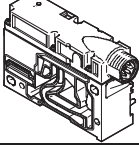
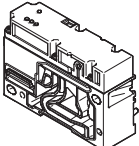
Ordering data				
Designation			Part No.	Type
<b>Manifold blocks – without electrical interlinking module</b>				
	For multi-pin plug/fieldbus	Four valve positions MPA1	544402	VMPAF-AP-4-1
		Two valve positions MPA2	544403	VMPAF-AP-2-2
	For multi-pin plug/fieldbus, duct 1 closed	Four valve positions MPA1	547504	VMPAF-AP-4-1-T1
		Two valve positions MPA2	547505	VMPAF-AP-2-2-T0
<b>Manifold blocks – incl. electrical manifold module and electronics module</b>				
	For fieldbus	Four valve positions MPA1	547492	VMPAF-AP-4-1-EMS-8
		Two valve positions MPA2	547493	VMPAF-AP-2-1-EMS-4
	For multi-pin plug	Eight solenoid coils MPA1	547494	VMPAF-AP-4-1-EMM-8
		Four solenoid coils MPA2	547495	VMPAF-AP-2-1-EMM-4
		Four solenoid coils MPA1	547496	VMPAF-AP-4-1-EMM-4
		Two solenoid coils MPA2	547497	VMPAF-AP-2-1-EMM-2
<b>Right-hand end plate</b>				
	Right-hand end plate, with selector switch for operation with internal or external pilot air supply		544401	VMPAF-FB-EPR
<b>Electrical interface for multi-pin plug connection</b>				
	Without exhaust plate, without flat plate silencer		544400	VMPAF-MPM-EPL
<b>Pneumatic interface for CPX plastic interlinking module</b>				
	Without exhaust plate, without flat plate silencer		544399	VMPAF-FB-EPL
	Without exhaust plate, without flat plate silencer, with integrated pressure sensor for duct 1		547491	VMPAF-FB-EPL-PS
<b>Pneumatic interface for CPX metal interlinking module</b>				
	Without exhaust plate, without flat plate silencer		552279	VMPAF-FB-EPLM
	Without exhaust plate, without flat plate silencer, with integrated pressure sensor for duct 1		552280	VMPAF-FB-EPLM-PS
<b>Electrical supply plate</b>				
	Plug connection M18, 3-pin		545349	VMPAF-FB-SP-V
	Plug connection 7/8", 5-pin		545351	VMPAF-FB-SP-7/8-V-5POL
	Plug connection 7/8", 4-pin		545350	VMPAF-FB-SP-7/8-V-4POL
<b>Pressure sensor</b>				
	For monitoring the operating pressure in duct 1		545352	VMPAF-FB-PS-1
	For monitoring the pressure in exhaust ducts 3 and 5		545353	VMPAF-FB-PS-3/5
	For monitoring an external process pressure		545354	VMPAF-FB-PS-P1

# Valve terminals type 33 MPA-F

Accessories



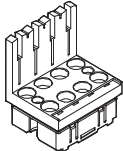
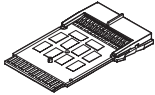
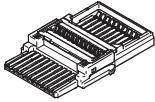
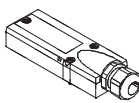

FESTO

Ordering data			
Designation		Part No.	Type
<b>Electronics modules</b>			
	For fieldbus connection, without isolated electrical circuit	4 coils MPA2	537983 VMPA2-FB-EMS-4
		8 coils MPA1	533360 VMPA1-FB-EMS-8
	For fieldbus connection, with isolated electrical circuit	4 coils MPA2	537984 VMPA2-FB-EMG-4
		8 coils MPA1	533361 VMPA1-FB-EMG-8
	For fieldbus connection, without isolated electrical circuit, with expanded diagnostics function	4 coils MPA2	543332 VMPA2-FB-EMS-D2-4
		8 coils MPA1	543331 VMPA1-FB-EMS-D2-8
	For fieldbus connection, with isolated electrical circuit, with expanded diagnostics function	4 coils MPA2	543334 VMPA2-FB-EMG-D2-4
		8 coils MPA1	543333 VMPA1-FB-EMG-D2-8
	For modular multi-pin plug connection (MPM)	2 coils MPA2	537985 VMPA2-MPM-EMM-2
		4 coils MPA2	537986 VMPA2-MPM-EMM-4
4 coils MPA1		537987 VMPA1-MPM-EMM-4	
8 coils MPA1		537988 VMPA1-MPM-EMM-8	
<b>Electrical manifold module for multi-pin plug connection</b>			
	For a manifold block	2 coils MPA2	544413 VMPAF-MPM-EV-AP-2
		4 coils MPA1, MPA2	544414 VMPAF-MPM-EV-AP-4
		8 coils MPA1	544515 VMPAF-MPM-EV-AP-8
	For a pneumatic supply plate	VMPAF-FB-SP-P	544416 VMPAF-MPM-EV-SP
<b>Electrical manifold module for fieldbus connection</b>			
	For a manifold block		544417 VMPAF-FB-EV-AP
	For pneumatic supply plate		544418 VMPAF-FB-EV-SP-P
	For electrical supply plate or pressure sensor		544419 VMPAF-FB-EV-SP-E
<b>Multi-pin plug connection, electrical</b>			
	Cover without connecting cable for self-assembly		533198 VMPA-KMS-H
	PVC connecting cable for 8 solenoid coils	2.5 m	533195 VMPA-KMS1-8-2,5
		5 m	533196 VMPA-KMS1-8-5
		10 m	533197 VMPA-KMS1-8-10
	PVC connecting cable for 24 solenoid coils	2.5 m	533192 VMPA-KMS1-24-2,5
		5 m	533193 VMPA-KMS1-24-5
		10 m	533194 VMPA-KMS1-24-10
	PUR connecting cable for 8 solenoid coils, suitable for energy chains	2.5 m	533504 VMPA-KMS2-8-2,5-PUR
		5 m	533505 VMPA-KMS2-8-5-PUR
		10 m	533506 VMPA-KMS2-8-10-PUR
	PUR connecting cable for 24 solenoid coils, suitable for energy chains	2.5 m	533501 VMPA-KMS2-24-2,5-PUR
		5 m	533502 VMPA-KMS2-24-5-PUR
		10 m	533503 VMPA-KMS2-24-10-PUR

# Valve terminals type 33 MPA-F

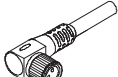
Accessories

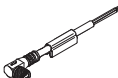
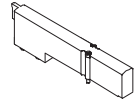
FESTO

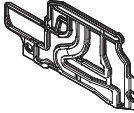
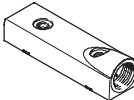
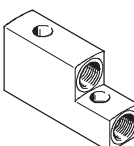
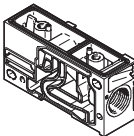



Ordering data				
Designation			Part No.	Type
<b>Individual electrical connection</b>				
	Plug socket with cable	2.5 m	158960	SIM-M8-4GD-2,5-PU
		5 m	158961	SIM-M8-4GD-5-PU
	Plug socket with cable	2.5 m	158962	SIM-M8-4WD-2,5-PU
		5 m	158963	SIM-M8-4WD-5-PU
	Connecting cable, straight socket	2.5 m	541342	NEBU-M8G4-K-2.5-LE4
		5 m	541343	NEBU-M8G4-K-5-LE4
	Connecting cable, angled socket	2.5 m	541344	NEBU-M8W4-K-2.5-LE4
		5 m	541345	NEBU-M8W4-K-5-LE4
<b>Cover</b>				
	Blanking plate for vacant valve position <sup>1)</sup>	Size 1	533351	VMPA1-RP
		Size 2	537962	VMPA2-RP
	Cover for manual override, non-detenting (10 pieces)		540897	VMPA-HBT-B
	Cover for manual override, covered (10 pieces)		540898	VMPA-HBV-B
<b>Separating seals for manifold rail</b>				
	Separating seal	No duct separation	544406	VMPAF-DP
		Duct 1 separate	544407	VMPAF-DP-P
		Duct 3/5 separate	544408	VMPAF-DP-RS
		Duct 1 and 3/5 separate	544409	VMPAF-DP-PRS
<b>Exhaust plate</b>				
	For left-hand end plate or power supply module, for ducted exhaust air, ducts 3/5 common		544411	VMPAF-AP-1
	For left-hand end plate or power supply module, for ducted exhaust air, duct 3 and duct 5 separate		544412	VMPAF-AP-2
<b>Pressure zone supply module</b>				
	Without silencer, without exhaust plate		544404	VMPAF-FB-SP-P

1) A self-adhesive label is supplied.

# Valve terminals type 33 MPA-F

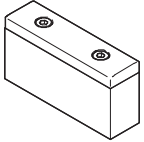
Accessories

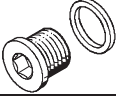
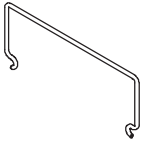
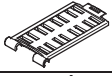
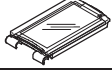
FESTO

Ordering data			
Designation		Part No.	Type
<b>Push-in fitting for manifold block, pneumatic interface, supply plate</b>			
	Connecting thread M7 for tubing O.D.	4 mm (10 pieces)	153319 QSM-M7-4-I
		6 mm (10 pieces)	153321 QSM-M7-6-I
	Connecting thread G $\frac{1}{4}$ for tubing O.D.	8 mm (10 pieces)	186110 QS-G $\frac{1}{4}$ -8-I
		10 mm (10 pieces)	186112 QS-G $\frac{1}{4}$ -10-I
		12 mm (10 pieces)	186104 QS-G $\frac{1}{2}$ -12-I
	Connecting thread G $\frac{1}{2}$ for tubing O.D.	16 mm (10 pieces)	186105 QS-G $\frac{1}{2}$ -16-I
<b>Silencer</b>			
	Flat plate silencer for left-hand end plate or power supply module		544410 VMPAF-APU
	Silencer, connecting thread G $\frac{1}{4}$		165004 UC- $\frac{1}{4}$
<b>Blanking plug</b>			
	Thread M7		174309 B-M7
	G $\frac{1}{4}$ thread		3569 B- $\frac{1}{4}$
	G $\frac{1}{2}$ thread		3571 B- $\frac{1}{2}$
<b>Inscription labels</b>			
	Holder for inscription label holder, 10 pieces		544421 VMPAF-STH
	Inscription label holder for manifold rail, for IBS, 10 pieces		544422 VMPAF-ST1
	Inscription label holder for manifold rail, transparent, for paper foil label, 10 pieces		546228 VMPAF-ST1T
	Inscription labels 9x20, 20 labels in frame		18182 IBS-9x20
<b>User documentation</b>			
	MPA-F Pneumatic components	German	547525 P.BE-MPAF-DE
		English	547526 P.BE-MPAF-EN
		French	547528 P.BE-MPAF-FR
		Spanish	547527 P.BE-MPAF-ES
		Italian	547529 P.BE-MPAF-IT
		Swedish	547530 P.BE-MPAF-SV
		MPA Electronics manual (pneumatic modules, pressure sensors, proportional pressure regulators, etc.)	German
	English		562113 P.BE-MPA-Elektronik-EN
	French		562115 P.BE-MPA-Elektronik-FR
	Spanish		562114 P.BE-MPA-Elektronik-ES
	Italian		562116 P.BE-MPA-Elektronik-IT
	Swedish		562117 P.BE-MPA-Elektronik-SV