

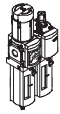

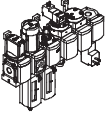



Service units MSB-FRC, MS series

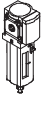

# Service units MSB-FRC, MS series

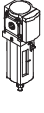
Product range overview – MS series service units

Type	Size	Pneumatic connection in housing	Connecting plate	Pressure regulation range [bar]						Grade of filtration [µm]			
				0.05	0.05	0.1	0.3	0.1	0.5				
				...	...	...	...	...	...	0.01	1	5	40
Code			AG...	D2	D4	D5	D6	D7	D8	A	B	C	E
<b>Service units</b>													
<b>MSB-FRC</b> 	4	G1/8, G1/4	G1/8, G1/4, G3/8	-	-	-	■	■	-	-	-	■	■
	6	G1/4, G3/8, G1/2	G1/4, G3/8, G1/2, G3/4	-	-	-	■	■	-	-	-	■	■
	9	-											
	12	-											
<b>Service unit combinations (further variants can be ordered using the configurator → Internet: msb4, msb6 or msb9)</b>													
<b>MSB</b> 	4	G1/4	G1/8, G1/4, G3/8	-	-	-	■	■	-	-	-	■	■
	6	G1/2	G1/4, G3/8, G1/2, G3/4	-	-	-	■	■	-	-	-	■	■
	9	-											
	12	-											
<b>Individual devices</b>													
<b>Filter regulators MS-LFR</b> 	4	G1/8, G1/4	G1/8, G1/4, G3/8	-	-	■	■	■	-	-	-	■	■
	6	G1/4, G3/8, G1/2	G1/4, G3/8, G1/2, G3/4	-	-	■	■	■	■	-	-	■	■
	9	G3/4, G1	G1/2, G3/4, G1, G1 1/4, G1 1/2	-	-	■	■	-	-	-	-	■	■
	12	-	G1, G1 1/4, G1 1/2, G2	-	-	-	■	■	■	-	-	■	■
<b>Filters MS-LF</b> 	4	G1/8, G1/4	G1/8, G1/4, G3/8	-	-	-	-	-	-	-	-	■	■
	6	G1/4, G3/8, G1/2	G1/4, G3/8, G1/2, G3/4	-	-	-	-	-	-	-	-	■	■
	9	G3/4, G1	G1/2, G3/4, G1, G1 1/4, G1 1/2	-	-	-	-	-	-	-	-	■	■
	12	-	G1, G1 1/4, G1 1/2, G2	-	-	-	-	-	-	-	-	■	■
<b>Fine and micro filters MS-LFM</b> 	4	G1/8, G1/4	G1/8, G1/4, G3/8	-	-	-	-	-	-	■	■	-	-
	6	G1/4, G3/8, G1/2	G1/4, G3/8, G1/2, G3/4	-	-	-	-	-	-	■	■	-	-
	9	G3/4, G1	G1/2, G3/4, G1, G1 1/4, G1 1/2	-	-	-	-	-	-	■	■	-	-
	12	-	G1, G1 1/4, G1 1/2, G2	-	-	-	-	-	-	■	■	-	-
<b>Activated carbon filters MS-LFX</b> 	4	G1/8, G1/4	G1/8, G1/4, G3/8	-	-	-	-	-	-	-	-	-	-
	6	G1/4, G3/8, G1/2	G1/4, G3/8, G1/2, G3/4	-	-	-	-	-	-	-	-	-	-
	9	G3/4, G1	G1/2, G3/4, G1, G1 1/4, G1 1/2	-	-	-	-	-	-	-	-	-	-
	12	-	G1, G1 1/4, G1 1/2, G2	-	-	-	-	-	-	-	-	-	-
<b>Water separators MS-LWS</b> 	4	-											
	6	G1/4, G3/8, G1/2	G1/4, G3/8, G1/2, G3/4	-	-	-	-	-	-	-	-	-	-
	9	-											
	12	-											

# Service units MSB-FRC, MS series

Product range overview – MS series service units

Type	Size	Bowl guard		Condensate drains				Pressure indicator				Security		Options		→ Page/ Internet	
		Plastic bowl with plastic bowl guard	Metal bowl	Manual rotary	Semi-automatic	Fully automatic	External, fully automatic, electrical	Cover plate (without pressure gauge)	Integrated MS pressure gauge	Adapter plate for EN pressure gauge G1/8	Adapter plate for EN pressure gauge G1/4	Pressure sensor	Rotary knob with detent, lockable via accessories	Rotary knob with integrated lock	Silencer		Flow direction from right to left
Code		R	U	M	H	V	E...	VS	AG	A8	A4	AD...	AS	E11	S	Z	
<b>Service units</b>																	
MSB-FRC	4	■	-	■	-	■	-	-	■	-	-	-	■	-	-	■	8
	6	■	■	■	-	■	-	-	■	-	-	-	■	-	-	■	8
	9	-	-	-	-	-	-	-	-	-	-	-	-	-	-	-	-
	12	-	-	-	-	-	-	-	-	-	-	-	-	-	-	-	-
<b>Service unit combinations</b>																	
MSB	4	■	■	■	-	■	-	-	■	-	-	-	■	-	-	■	msb4
	6	■	■	■	-	■	-	-	■	-	-	-	■	-	-	■	msb6
	9	-	-	-	-	-	-	-	-	-	-	-	-	-	-	-	-
	12	-	-	-	-	-	-	-	-	-	-	-	-	-	-	-	-
<b>Individual devices</b>																	
Filter regulators MS-LFR	4	■	■	■	■	■	-	■	■	■	■	■	■	■	-	■	ms4-lfr
	6	■	■	■	■	■	■	■	■	-	■	■	■	■	-	■	ms6-lfr
	9	-	■	■	■	■	■	■	■	-	■	■	■	■	-	■	ms9-lfr
	12	-	■	■	-	■	■	■	■	-	■	-	■	■	-	■	ms12-lfr
Filters MS-LF	4	■	■	■	■	■	-	-	-	-	-	-	-	-	-	■	ms4-lf
	6	■	■	■	■	■	■	-	-	-	-	-	-	-	-	■	ms6-lf
	9	-	■	■	■	■	■	-	-	-	-	-	-	-	-	■	ms9-lf
	12	-	■	■	-	■	■	-	-	-	-	-	-	-	-	■	ms12-lf
Fine and micro filters MS-LFM	4	■	■	■	■	■	-	-	-	-	-	-	-	-	-	■	ms4-lfm
	6	■	■	■	■	■	■	-	-	-	-	-	-	-	-	■	ms6-lfm
	9	-	■	■	-	■	■	-	-	-	-	-	-	-	-	■	ms9-lfm
	12	-	■	■	-	■	■	-	-	-	-	-	-	-	-	■	ms12-lfm
Activated carbon filters MS-LFX	4	■	■	-	-	-	-	-	-	-	-	-	-	-	-	■	ms4-lfx
	6	■	■	-	-	-	-	-	-	-	-	-	-	-	-	■	ms6-lfx
	9	-	■	-	-	-	-	-	-	-	-	-	-	-	-	■	ms9-lfx
	12	-	■	-	-	-	-	-	-	-	-	-	-	-	-	■	ms12-lfx
Water separators MS-LWS	4	-	-	-	-	-	-	-	-	-	-	-	-	-	-	-	-
	6	-	■	-	-	■	■	-	-	-	-	-	-	-	-	■	ms6-lws
	9	-	-	-	-	-	-	-	-	-	-	-	-	-	-	-	-
	12	-	-	-	-	-	-	-	-	-	-	-	-	-	-	-	-

# Service units MSB-FRC, MS series

Product range overview – MS series service units



Type	Size	Pneumatic connection in housing	Connecting plate	Pressure regulation range [bar]						Supply voltage			
				0.05 ... 0.7	0.05 ... 2.5	0.1 ... 4	0.3 ... 7	0.1 ... 12	0.5 ... 16	24 V DC, connection pattern to EN 175301	24 V DC, connection pattern M12 to DESINA	110 V AC, connection pattern to EN 175301	230 V AC, connection pattern to EN 175301
Code			AG...	D2	D4	D5	D6	D7	D8	V24	V24P	V110	V230
<b>Individual devices</b>													
Pressure regulators <b>MS-LR</b>		4	G1/8, G1/4	G1/8, G1/4, G3/8	-	-	■	■	■	-	-	-	-
		6	G1/4, G3/8, G1/2	G1/4, G3/8, G1/2, G3/4	-	-	■	■	■	■	-	-	-
		9	G3/4, G1	G1/2, G3/4, G1, G1 1/4, G1 1/2	-	-	■	■	-	-	-	-	-
		12	-	G1, G1 1/4, G1 1/2, G2	-	-	-	■	■	■	-	-	-
Pressure regulators <b>MS-LRB</b>		4	G1/4	G1/8, G1/4, G3/8	-	-	■	■	■	-	-	-	-
		6	G1/2	G1/4, G3/8, G1/2, G3/4	-	-	■	■	■	■	-	-	-
		9	-										
		12	-										
Precision pressure regulators <b>MS-LRP</b>		4	-										
		6	G1/4, G3/8, G1/2	G1/4, G3/8, G1/2, G3/4	■	■	■	-	■	-	-	-	-
		9	-										
		12	-										
Precision pressure regulators <b>MS-LRPB</b>		4	-										
		6	G1/2	G1/4, G3/8, G1/2, G3/4	■	■	■	-	■	-	-	-	-
		9	-										
		12	-										
Electrical pressure regulators <b>MS-LRE</b>		4	-										
		6	G1/4, G3/8, G1/2	G1/4, G3/8, G1/2, G3/4	-	-	■	■	■	■	-	-	-
		9	-										
		12	-										
Lubricators <b>MS-LOE</b>		4	G1/8, G1/4	G1/8, G1/4, G3/8	-	-	-	-	-	-	-	-	-
		6	G1/4, G3/8, G1/2	G1/4, G3/8, G1/2, G3/4	-	-	-	-	-	-	-	-	-
		9	-										
		12	-	G1, G1 1/4, G1 1/2, G2	-	-	-	-	-	-	-	-	-
Electrical on-off valves <b>MS-EM(1)</b>		4	G1/8, G1/4	G1/8, G1/4, G3/8	-	-	-	-	-	-	-	-	-
		6	G1/4, G3/8, G1/2	G1/4, G3/8, G1/2, G3/4	-	-	-	-	-	-	-	-	-
		9	G3/4, G1	G1/2, G3/4, G1, G1 1/4, G1 1/2	-	-	-	-	-	-	-	-	-
		12	-	G1, G1 1/4, G1 1/2, G2	-	-	-	-	-	-	-	-	-
Electrical on-off valves <b>MS-EE</b>		4	G1/8, G1/4	G1/8, G1/4, G3/8	-	-	-	-	-	-	■	-	■
		6	G1/4, G3/8, G1/2	G1/4, G3/8, G1/2, G3/4	-	-	-	-	-	-	■	-	■
		9	G3/4, G1	G1/2, G3/4, G1, G1 1/4, G1 1/2	-	-	-	-	-	-	■	■	■
		12	-	G1, G1 1/4, G1 1/2, G2	-	-	-	-	-	-	■	■	■
Electrical soft-start valves <b>MS-DL</b>		4	G1/8, G1/4	G1/8, G1/4, G3/8	-	-	-	-	-	-	-	-	-
		6	G1/4, G3/8, G1/2	G1/4, G3/8, G1/2, G3/4	-	-	-	-	-	-	-	-	-
		9	-										
		12	-	G1, G1 1/4, G1 1/2, G2	-	-	-	-	-	-	-	-	-
Electrical soft-start valves <b>MS-DE</b>		4	G1/8, G1/4	G1/8, G1/4, G3/8	-	-	-	-	-	-	■	-	■
		6	G1/4, G3/8, G1/2	G1/4, G3/8, G1/2, G3/4	-	-	-	-	-	-	■	-	■
		9	-										
		12	-	G1, G1 1/4, G1 1/2, G2	-	-	-	-	-	-	■	■	■
Soft start and exhaust valves <b>MS-SV</b>		4	-										
		6	G1/2	G1/4, G3/8, G1/2, G3/4	-	-	-	-	-	-	■	-	-
		9	-										
		12	-										

# Service units MSB-FRC, MS series

Product range overview – MS series service units







Type	Size	Bowl guard		Pressure indicator				Security		Options		→ Page/ Internet	
		Plastic bowl with plastic bowl guard	Metal bowl	Cover plate (without pressure gauge)	Integrated MS pressure gauge	Adapter plate for EN pressure gauge G1/8	Adapter plate for EN pressure gauge G1/4	Pressure sensor	Rotary knob with detent, lockable via accessories	Rotary knob with integrated lock	Silencer		Flow direction from right to left
Code		R	U	VS	AG	A8	A4	AD...	AS	E11	S	Z	
<b>Individual devices</b>													
Pressure regulators <b>MS-LR</b>	4	-	-	■	■	■	■	■	■	■	-	■	ms4-lr
	6	-	-	■	■	-	■	■	■	■	-	■	ms6-lr
	9	-	-	■	■	-	■	■	■	■	-	■	ms9-lr
	12	-	-	■	■	-	■	-	■	■	-	■	ms12-lr
Pressure regulators <b>MS-LRB</b>	4	-	-	■	■	■	■	■	■	■	-	■	ms4-lrb
	6	-	-	■	■	-	■	■	■	■	-	■	ms6-lrb
	9	-	-	-	-	-	-	-	-	-	-	-	-
	12	-	-	-	-	-	-	-	-	-	-	-	-
Precision pressure regulators <b>MS-LRP</b>	4	-	-	-	-	-	-	-	-	-	-	-	-
	6	-	-	■	-	■	■	■	■	■	-	■	ms6-lrp
	9	-	-	-	-	-	-	-	-	-	-	-	-
	12	-	-	-	-	-	-	-	-	-	-	-	-
Precision pressure regulators <b>MS-LRPB</b>	4	-	-	-	-	-	-	-	-	-	-	-	-
	6	-	-	■	-	■	■	■	■	■	-	■	ms6-lrpb
	9	-	-	-	-	-	-	-	-	-	-	-	-
	12	-	-	-	-	-	-	-	-	-	-	-	-
Electrical pressure regulators <b>MS-LRE</b>	4	-	-	-	-	-	-	-	-	-	-	-	-
	6	-	-	■	■	-	■	-	-	-	-	■	ms6-lre
	9	-	-	-	-	-	-	-	-	-	-	-	-
	12	-	-	-	-	-	-	-	-	-	-	-	-
Lubricators <b>MS-LOE</b>	4	■	■	-	-	-	-	-	-	-	-	■	ms4-loe
	6	■	■	-	-	-	-	-	-	-	-	■	ms6-loe
	9	-	-	-	-	-	-	-	-	-	-	-	-
	12	-	■	-	-	-	-	-	-	-	-	■	ms12-loe
Electrical on-off valves <b>MS-EM(1)</b>	4	-	-	■	■	■	■	■	-	-	■	■	ms4-em1
	6	-	-	■	■	-	■	■	-	-	■	■	ms6-em1
	9	-	-	■	■	-	■	■	-	-	■	■	ms9-em
	12	-	-	■	■	-	■	-	-	-	■	■	ms12-em
Electrical on-off valves <b>MS-EE</b>	4	-	-	■	■	■	■	■	-	-	■	■	ms4-ee
	6	-	-	■	■	-	■	■	-	-	■	■	ms6-ee
	9	-	-	■	■	-	■	■	-	-	■	■	ms9-ee
	12	-	-	■	■	-	■	-	-	-	■	■	ms12-ee
Electrical soft-start valves <b>MS-DL</b>	4	-	-	■	■	■	■	■	-	-	-	■	ms4-dl
	6	-	-	■	■	-	■	■	-	-	-	■	ms6-dl
	9	-	-	-	-	-	-	-	-	-	-	-	-
	12	-	-	■	■	-	■	-	-	-	-	■	ms12-dl
Electrical soft-start valves <b>MS-DE</b>	4	-	-	■	■	■	■	■	-	-	-	■	ms4-de
	6	-	-	■	■	-	■	■	-	-	-	■	ms6-de
	9	-	-	-	-	-	-	-	-	-	-	-	-
	12	-	-	■	■	-	■	-	-	-	-	■	ms12-de
Soft start and exhaust valves <b>MS-SV</b>	4	-	-	-	-	-	-	-	-	-	-	-	-
	6	-	-	■	■	-	■	■	-	-	■	■	ms6-sv
	9	-	-	-	-	-	-	-	-	-	-	-	-
	12	-	-	-	-	-	-	-	-	-	-	-	-

# Service units MSB-FRC, MS series

Product range overview – MS series service units



Type	Size	Pneumatic connection in housing	Connecting plate	Pressure regulation range [bar]				Supply voltage				
				0.1 ... 4	0.3 ... 7	0.1 ... 12	0.5 ... 16	24 V DC, connection pattern to EN 175301	24 V DC, connection pattern M12 to DESINA	110 V AC, connection pattern to EN 175301	230 V AC, connection pattern to EN 175301	
Code			AG...	D5	D6	D7	D8	V24	V24P	V110	V230	
<b>Individual devices</b>												
Membrane air dryers <b>MS-LDM1</b>		4	G1/8, G1/4	G1/8, G1/4, G3/8	-	-	-	-	-	-	-	-
		6	G1/4, G3/8, G1/2	G1/4, G3/8, G1/2, G3/4	-	-	-	-	-	-	-	-
		9	-	-	-	-	-	-	-	-	-	-
		12	-	-	-	-	-	-	-	-	-	-
Branching modules <b>MS-FRM</b>		4	G1/8, G1/4	G1/8, G1/4, G3/8	-	-	-	-	-	-	-	-
		6	G1/4, G3/8, G1/2	G1/4, G3/8, G1/2, G3/4	-	-	-	-	-	-	-	-
		9	G3/4, G1	G1/2, G3/4, G1, G1 1/4, G1 1/2	-	-	-	-	-	-	-	-
		12	-	G1, G1 1/4, G1 1/2, G2	-	-	-	-	-	-	-	-
Distributor blocks <b>MS-FRM-FRZ</b>		4	G1/4	-	-	-	-	-	-	-	-	-
		6	G1/2	-	-	-	-	-	-	-	-	-
		9	-	-	-	-	-	-	-	-	-	-
		12	-	-	-	-	-	-	-	-	-	-
Flow sensors <b>SFAM</b>		4	-	-	-	-	-	-	-	-	-	-
		6	G1/2	G1/2	-	-	-	-	-	-	-	-
		9	-	-	-	-	-	-	-	-	-	-
		12	-	-	-	-	-	-	-	-	-	-

# Service units MSB-FRC, MS series

Product range overview – MS series service units

Type	Size	Bowl guard		Pressure indicator				Switch output		Options		→ Page/ Internet	
		Plastic bowl with plastic bowl guard	Metal bowl	Cover plate (without pressure gauge)	Integrated MS pressure gauge	Adapter plate for EN pressure gauge G1/8	Adapter plate for EN pressure gauge G1/4	Pressure sensor	2x PNP	2x NPN	Silencer		Flow direction from right to left
Code		R	U	VS	AG	A8	A4	AD...	P2/2S	N2/2S	S	Z/R	
<b>Individual devices</b>													
Membrane air dryers <b>MS-LDM1</b>	4	-	■	-	-	-	-	-	-	-	-	■	ms4-ldm1
	6	-	■	-	-	-	-	-	-	-	-	■	ms6-ldm1
	9	-	-	-	-	-	-	-	-	-	-	-	-
	12	-	-	-	-	-	-	-	-	-	-	-	-
Branching modules <b>MS-FRM</b>	4	-	-	■	■	■	■	■	-	-	-	■	ms4-frm
	6	-	-	■	■	-	■	■	-	-	-	■	ms6-frm
	9	-	-	■	■	-	■	■	-	-	-	■	ms9-frm
	12	-	-	■	-	-	-	-	-	-	-	-	ms12-frm
Distributor blocks <b>MS-FRM-FRZ</b>	4	-	-	-	-	-	-	-	-	-	-	■	ms4-frm
	6	-	-	-	-	-	-	-	-	-	-	■	ms6-frm
	9	-	-	-	-	-	-	-	-	-	-	-	-
	12	-	-	-	-	-	-	-	-	-	-	-	-
Flow sensors <b>SFAM</b>	4	-	-	-	-	-	-	-	-	-	-	-	-
	6	-	-	-	-	-	-	-	■	■	-	■	sfam
	9	-	-	-	-	-	-	-	-	-	-	-	-
	12	-	-	-	-	-	-	-	-	-	-	-	-

## Service units MSB4/MSB6-FRC, MS series

Peripherals overview

FESTO

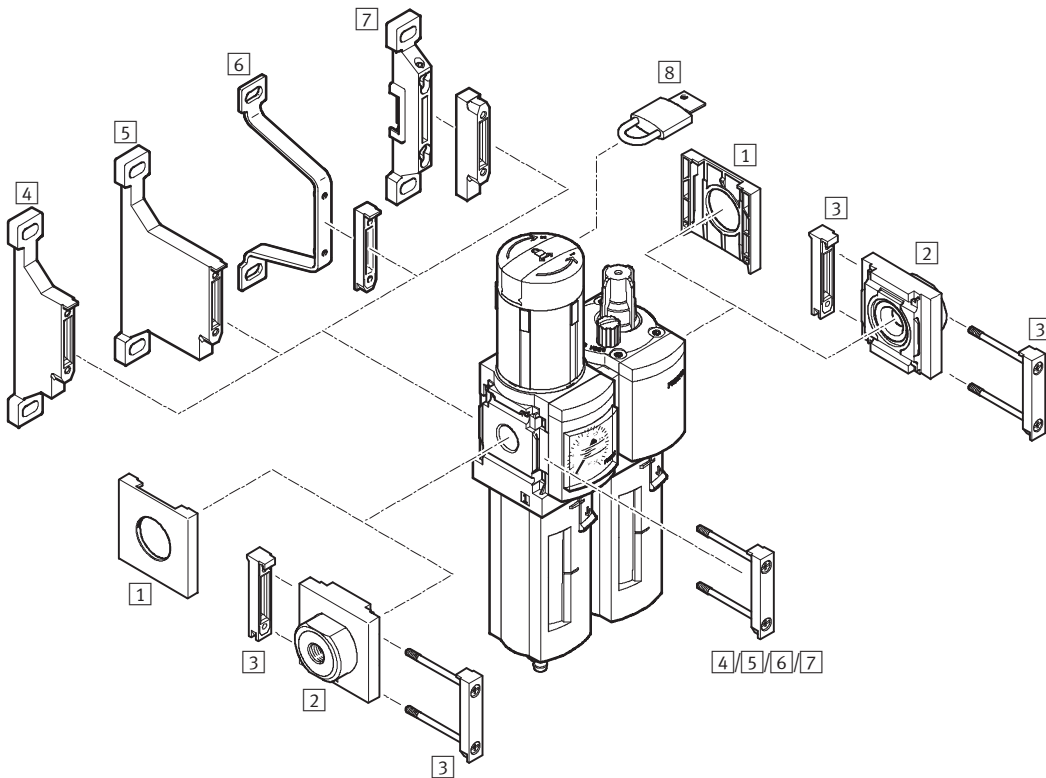

Mounting attachments and accessories		→ Page/Internet
1	Cover cap MS4/6-END	ms4-end, ms6-end
2	Connecting plate MS4/6-AG...	ms4-ag, ms6-ag
3	Module connector MS4/6-MV	ms4-mv, ms6-mv
4	Mounting bracket MS4/6-WP	ms4-wp, ms6-wp
5	Mounting bracket MS4/6-WPB	ms4-wp, ms6-wp
6	Mounting bracket MS4/6-WPE	ms4-wp, ms6-wp
7	Mounting bracket MS4/6-WPM	ms4-wp, ms6-wp
8	Padlock LRVS-D	17



# Service units MSB4/MSB6-FRC, MS series

Type codes

MSB 6 - 3/8 - FRC2:J6 M1

Series	
MSB	Service unit

Size	
4	Grid dimension 40 mm
6	Grid dimension 62 mm

Pneumatic connection	
MSB4	
1/8	Thread G1/8
1/4	Thread G1/4
MSB6	
1/4	Thread G1/4
3/8	Thread G3/8
1/2	Thread G1/2

- Service unit consisting of:**
- Filter regulator with pressure gauge, rotary knob with detent, lockable via accessories
  - Lubricator

Pressure regulation range 0.3 ... 7 bar	
Plastic bowl guard	
FRC3:J7	Grade of filtration 5 µm, manual rotary condensate drain
FRC4:J8	Grade of filtration 5 µm, fully automatic condensate drain
FRC1:J5	Grade of filtration 40 µm, manual rotary condensate drain
FRC2:J6	Grade of filtration 40 µm, fully automatic condensate drain

Pressure regulation range 0.5 ... 12 bar	
Plastic bowl guard	
FRC7:J3	Grade of filtration 5 µm, manual rotary condensate drain
FRC8:J4	Grade of filtration 5 µm, fully automatic condensate drain
FRC5:J1	Grade of filtration 40 µm, manual rotary condensate drain
FRC6:J2	Grade of filtration 40 µm, fully automatic condensate drain

Metal bowl	
FRC11:J9	Grade of filtration 5 µm, manual rotary condensate drain
FRC12:J10	Grade of filtration 5 µm, fully automatic condensate drain
FRC9:J11	Grade of filtration 40 µm, manual rotary condensate drain
FRC10:J12	Grade of filtration 40 µm, fully automatic condensate drain

Lubricators	
M1	Plastic bowl guard
M2	Metal bowl

# Service units MSB4/MSB6-FRC, MS series

Technical data

FESTO

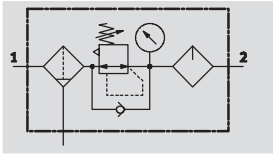

Function

With condensate drain  
manual rotary

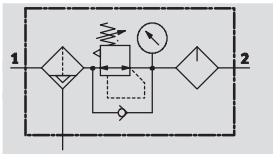

With condensate drain  
fully automatic



-  - Flow rate  
800 ... 4,800 l/min
-  - Temperature range  
-10 ... +60 °C
-  - Input pressure  
1.5 ... 20 bar



- Filter, regulator and lubricator function in a single unit
- High flow rate and highly efficient removal of contaminants
- Good regulating characteristics with minimal pressure hysteresis
- Setting values are secured by locking the rotary knob
- Lockable rotary knob
- Two pressure regulation ranges: 0.3 ... 7 bar and 0.5 ... 12 bar
- With manual or integrated, fully automatic condensate drain
- Choice of filter cartridges: 5 µm or 40 µm
- New filter cartridges → 17, Festo special oil → 17

General technical data					
Size	MSB4		MSB6		
Pneumatic connection 1, 2	G $\frac{1}{8}$	G $\frac{1}{4}$	G $\frac{1}{4}$	G $\frac{3}{8}$	G $\frac{1}{2}$
Design	Filter regulator with pressure gauge Proportional standard mist lubricator				
Regulating function	With primary pressure compensation With secondary venting With return flow function Output pressure constant				
Type of mounting	Via accessories				
Assembly position	Vertical $\pm 5^\circ$				
Grade of filtration [µm]	5 (air purity class at the output 3.7.- to DIN ISO 8573-1) 40 (air purity class at the output 5.7.- to DIN ISO 8573-1)				
Bowl guard	Plastic bowl guard		Plastic bowl guard		
	-		Metal bowl guard		
Condensate drains	Manual rotary Fully automatic				
Actuator lock	Rotary knob with detent, lockable via accessories				
Pressure regulation range [bar]	0.3 ... 7 0.5 ... 12				
Pressure indicator	With pressure gauge				

-  - Note: This product conforms to ISO 1179-1 and to ISO 228-1

# Service units MSB4/MSB6-FRC, MS series

Technical data

Standard nominal flow rate $q_{nN}^{1)}$ [l/min]						
Size	MSB4			MSB6		
Pneumatic connection	G $\frac{1}{8}$	G $\frac{1}{4}$	G $\frac{1}{4}$	G $\frac{3}{8}$	G $\frac{1}{2}$	G $\frac{1}{2}$
Pressure regulation range 0.3... 7 bar						
Grade of filtration	5 $\mu$ m	900	1,300	2,000	4,400	4,600
	40 $\mu$ m	950	1,400	2,100	4,600	4,800
Pressure regulation range 0.5... 12 bar						
Grade of filtration	5 $\mu$ m	800	850	1,700	3,400	3,600
	40 $\mu$ m	850	900	1,900	3,500	3,700

1) Measured at  $p_1 = 10$  bar and  $p_2 = 6$  bar,  $\Delta p = 1$  bar.

Operating and environmental conditions				
Condensate drains		Manual rotary		Fully automatic
Size	MSB4	MSB6	MSB4	MSB6
Supply pressure [bar]	1.5 ... 14	1.5 ... 20	1.5 ... 12	1.5 ... 12
Operating medium	Compressed air			
Ambient temperature [°C]	-10 ... +60		+5 ... +60	
Temperature of medium [°C]	-10 ... +60		+5 ... +60	
Storage temperature [°C]	-10 ... +60		-10 ... +60	
Corrosion resistance	CRC <sup>1)</sup>	2		

1) Corrosion resistance class 2 according to Festo standard 940 070  
 Components requiring moderate corrosion resistance. Externally visible parts with primarily decorative surface requirements which are in direct contact with a normal industrial environment or media such as coolants or lubricating agents.

Weights [g]		
Size	MSB4	MSB6
With plastic bowl guard	500	1,495
With metal bowl guard	-	1,713

## Materials

Sectional view

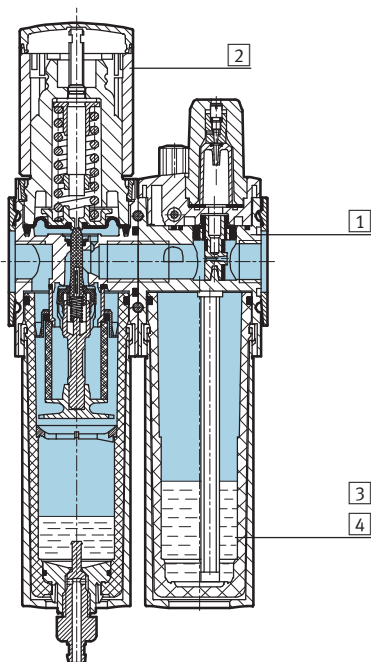

Service unit		
1	Body	Die-cast aluminium
2	Regulating knob	Polyamide/polyacetate
3	Plastic bowl guard	Polycarbonate
4	Metal bowl guard	Wrought aluminium alloy
-	Seals	Nitrile rubber

# Service units MSB4/MSB6-FRC, MS series

Technical data



## Standard flow rate $q_n$ as a function of output pressure $p_2$

Pressure regulation range 0.3 ... 7 bar Grade of filtration 5  $\mu\text{m}$

MSB4-1/8

Primary pressure  $p_1 = 10$  bar

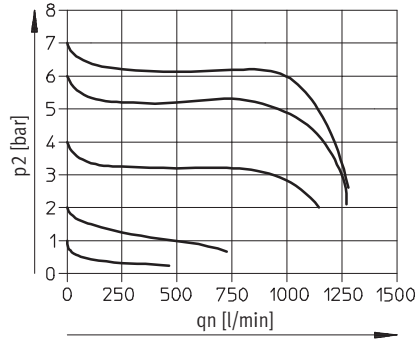

Grade of filtration 40  $\mu\text{m}$

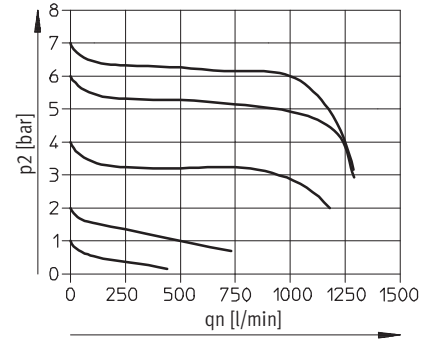

## MSB4-1/4

Primary pressure  $p_1 = 10$  bar

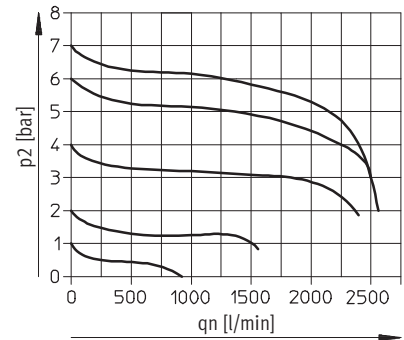
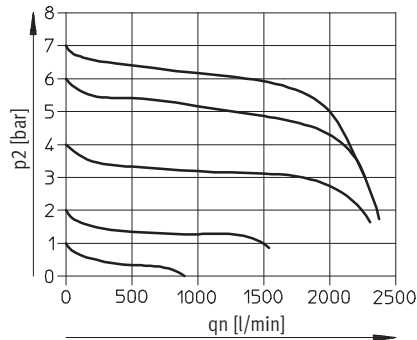

Pressure regulation range 0.5 ... 12 bar Grade of filtration 5  $\mu\text{m}$

MSB4-1/8

Primary pressure  $p_1 = 10$  bar

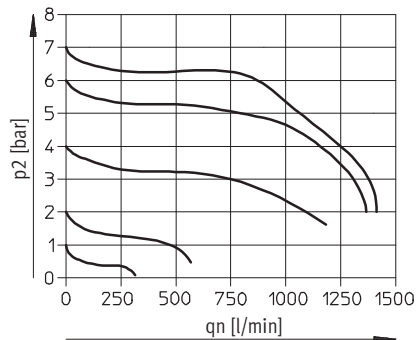

Grade of filtration 40  $\mu\text{m}$

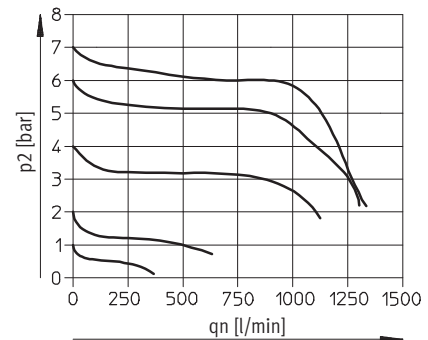

## MSB4-1/4

Primary pressure  $p_1 = 10$  bar

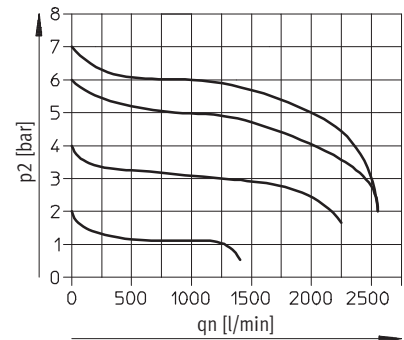
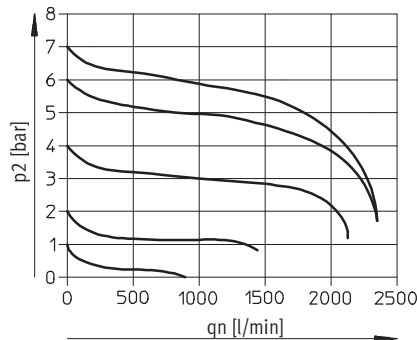

# Service units MSB4/MSB6-FRC, MS series

Technical data

## Standard flow rate $q_n$ as a function of output pressure $p_2$

Pressure regulation range 0.3 ... 7 bar

Grade of filtration 5  $\mu\text{m}$

Grade of filtration 40  $\mu\text{m}$

MSB6-1/4

Primary pressure  $p_1 = 10$  bar

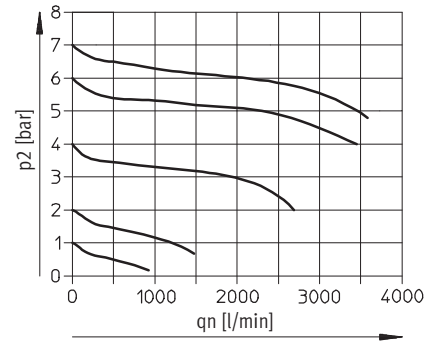
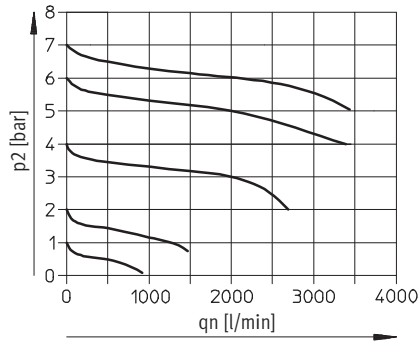

## MSB6-3/8

Primary pressure  $p_1 = 10$  bar

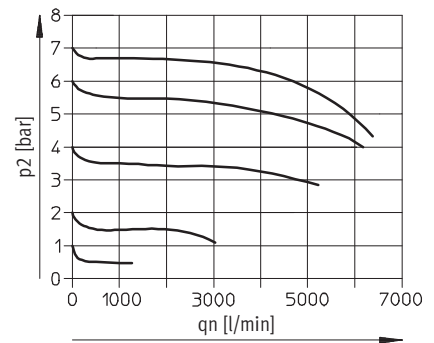
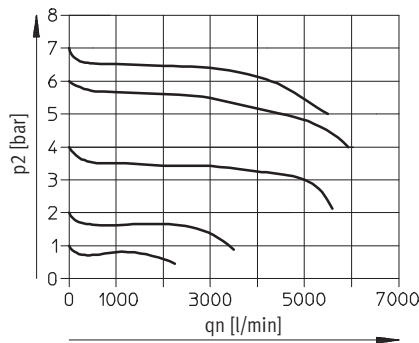

## MSB6-1/2

Primary pressure  $p_1 = 10$  bar

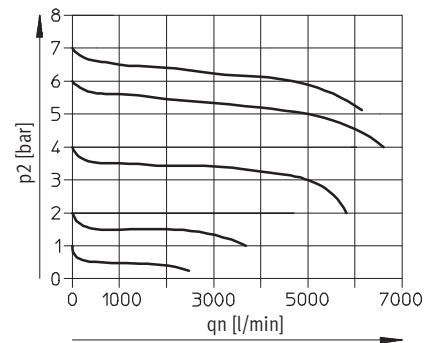
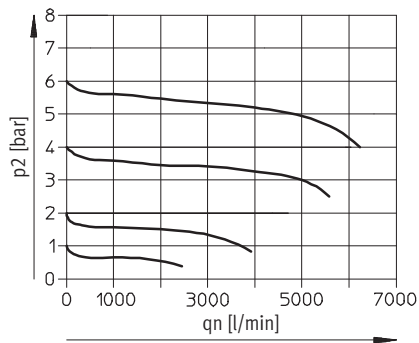

# Service units MSB4/MSB6-FRC, MS series

Technical data

## Standard flow rate $q_n$ as a function of output pressure $p_2$

Pressure regulation range 0.5 ... 12 bar Grade of filtration 5  $\mu\text{m}$

MSB6-1/4

Primary pressure  $p_1 = 10$  bar

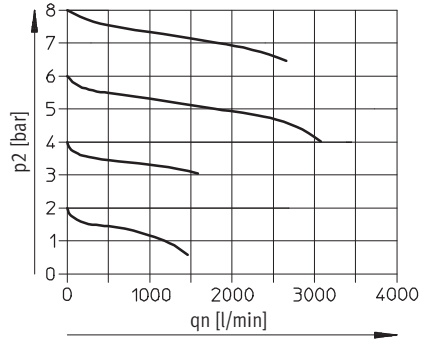

Grade of filtration 40  $\mu\text{m}$

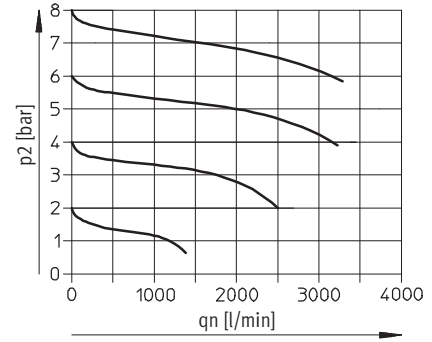

## MSB6-3/8

Primary pressure  $p_1 = 10$  bar

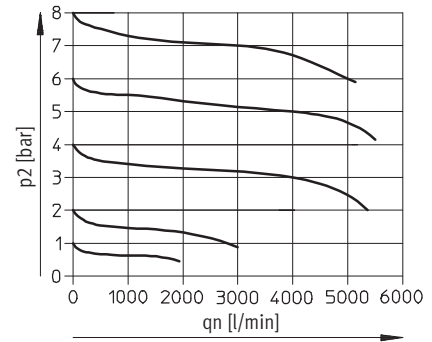
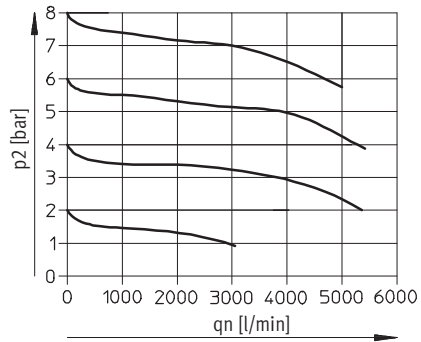

## MSB6-1/2

Primary pressure  $p_1 = 10$  bar

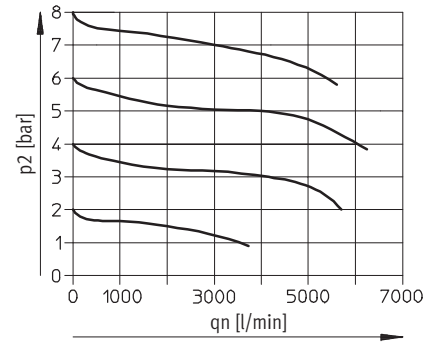
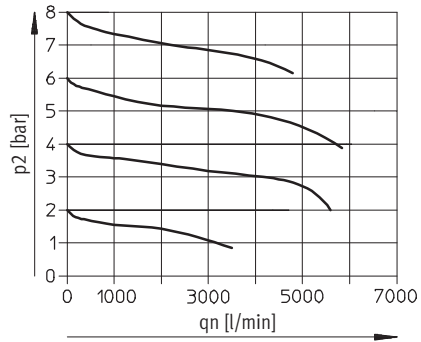

# Service units MSB4/MSB6-FRC, MS series

Technical data

FESTO

## Dimensions

Download CAD data → [www.festo.com](http://www.festo.com)

With pressure gauge, display unit [bar]

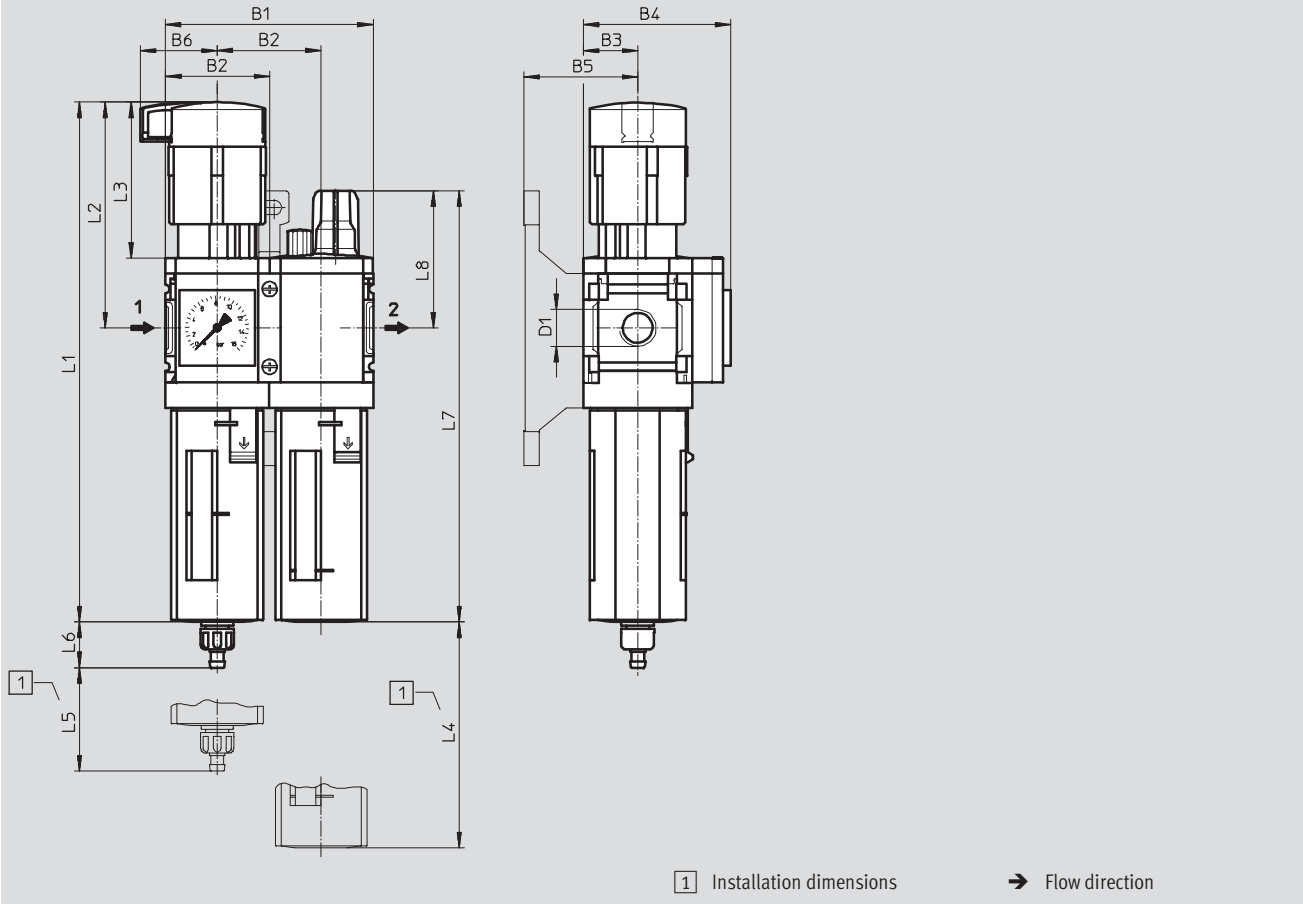

Type	B1	B2	B3	B4	B5	B6	D1	L1	L2	L3	L4	L5	L6		L7	L8
													Condensate drain manual rotary	Condensate drain fully auto- matic		
MSB4-1/8	80.4	40.2	21	57	44	29.7	G1/8	201	87	60	80	25	17.7	20.4	167	53
MSB4-1/4							G1/4									
MSB6-1/4	124	62	31	77	54	38.8	G1/4	284.8	134.5	95.5	130	68	15.8	18.5	215.3	65.6
MSB6-3/8							G3/8									
MSB6-1/2							G1/2									

- | - Note: This product conforms to ISO 1179-1 and to ISO 228-1

# Service units MSB4/MSB6-FRC, MS series

FESTO

Technical data

Ordering data						
Pressure regulation range 0.3 ... 7 bar						
Size	Condensate drain	Connection	Grade of filtration 5 µm		Grade of filtration 40 µm	
			Part No.	Type	Part No.	Type
Plastic bowl guard						
MSB4	manual rotary	G $\frac{1}{8}$	531129	MSB4- $\frac{1}{8}$ -FRC3:J7M1	531125	MSB4- $\frac{1}{8}$ -FRC1:J5M1
		G $\frac{1}{4}$	531113	MSB4- $\frac{1}{4}$ -FRC3:J7M1	531109	MSB4- $\frac{1}{4}$ -FRC1:J5M1
	fully automatic	G $\frac{1}{8}$	531131	MSB4- $\frac{1}{8}$ -FRC4:J8M1	531127	MSB4- $\frac{1}{8}$ -FRC2:J6M1
		G $\frac{1}{4}$	531115	MSB4- $\frac{1}{4}$ -FRC4:J8M1	531111	MSB4- $\frac{1}{4}$ -FRC2:J6M1
MSB6	manual rotary	G $\frac{1}{4}$	530264	MSB6- $\frac{1}{4}$ -FRC3:J7M1	530254	MSB6- $\frac{1}{4}$ -FRC1:J5M1
		G $\frac{3}{8}$	530288	MSB6- $\frac{3}{8}$ -FRC3:J7M1	530278	MSB6- $\frac{3}{8}$ -FRC1:J5M1
		G $\frac{1}{2}$	530240	MSB6- $\frac{1}{2}$ -FRC3:J7M1	530230	MSB6- $\frac{1}{2}$ -FRC1:J5M1
	fully automatic	G $\frac{1}{4}$	530266	MSB6- $\frac{1}{4}$ -FRC4:J8M1	530262	MSB6- $\frac{1}{4}$ -FRC2:J6M1
		G $\frac{3}{8}$	530290	MSB6- $\frac{3}{8}$ -FRC4:J8M1	530286	MSB6- $\frac{3}{8}$ -FRC2:J6M1
		G $\frac{1}{2}$	530242	MSB6- $\frac{1}{2}$ -FRC4:J8M1	530238	MSB6- $\frac{1}{2}$ -FRC2:J6M1

Ordering data						
Pressure regulation range 0.5 ... 12 bar						
Size	Condensate drain	Connection	Grade of filtration 5 µm		Grade of filtration 40 µm	
			Part No.	Type	Part No.	Type
Plastic bowl guard						
MSB4	manual rotary	G $\frac{1}{8}$	531137	MSB4- $\frac{1}{8}$ -FRC7:J3M1	531133	MSB4- $\frac{1}{8}$ -FRC5:J1M1
		G $\frac{1}{4}$	531121	MSB4- $\frac{1}{4}$ -FRC7:J3M1	531117	MSB4- $\frac{1}{4}$ -FRC5:J1M1
	fully automatic	G $\frac{1}{8}$	531139	MSB4- $\frac{1}{8}$ -FRC8:J4M1	531135	MSB4- $\frac{1}{8}$ -FRC6:J2M1
		G $\frac{1}{4}$	531123	MSB4- $\frac{1}{4}$ -FRC8:J4M1	531119	MSB4- $\frac{1}{4}$ -FRC6:J2M1
MSB6	manual rotary	G $\frac{1}{4}$	530272	MSB6- $\frac{1}{4}$ -FRC7:J3M1	530268	MSB6- $\frac{1}{4}$ -FRC5:J1M1
		G $\frac{3}{8}$	530296	MSB6- $\frac{3}{8}$ -FRC7:J3M1	530292	MSB6- $\frac{3}{8}$ -FRC5:J1M1
		G $\frac{1}{2}$	530248	MSB6- $\frac{1}{2}$ -FRC7:J3M1	530244	MSB6- $\frac{1}{2}$ -FRC5:J1M1
	fully automatic	G $\frac{1}{4}$	530274	MSB6- $\frac{1}{4}$ -FRC8:J4M1	530270	MSB6- $\frac{1}{4}$ -FRC6:J2M1
		G $\frac{3}{8}$	530298	MSB6- $\frac{3}{8}$ -FRC8:J4M1	530294	MSB6- $\frac{3}{8}$ -FRC6:J2M1
		G $\frac{1}{2}$	530250	MSB6- $\frac{1}{2}$ -FRC8:J4M1	530246	MSB6- $\frac{1}{2}$ -FRC6:J2M1
Metal bowl						
MSB6	manual rotary	G $\frac{1}{4}$	530258	MSB6- $\frac{1}{4}$ -FRC11:J9M2	530276	MSB6- $\frac{1}{4}$ -FRC9:J11M2
		G $\frac{3}{8}$	530282	MSB6- $\frac{3}{8}$ -FRC11:J9M2	530300	MSB6- $\frac{3}{8}$ -FRC9:J11M2
		G $\frac{1}{2}$	530234	MSB6- $\frac{1}{2}$ -FRC11:J9M2	530252	MSB6- $\frac{1}{2}$ -FRC9:J11M2
	fully automatic	G $\frac{1}{4}$	530260	MSB6- $\frac{1}{4}$ -FRC12:J10M2	530256	MSB6- $\frac{1}{4}$ -FRC10:J12M2
		G $\frac{3}{8}$	530284	MSB6- $\frac{3}{8}$ -FRC12:J10M2	530280	MSB6- $\frac{3}{8}$ -FRC10:J12M2
		G $\frac{1}{2}$	530236	MSB6- $\frac{1}{2}$ -FRC12:J10M2	530232	MSB6- $\frac{1}{2}$ -FRC10:J12M2



## Service units MSB-FRC, MS series

Accessories

### Filter cartridges



Ordering data			
Size	Grade of filtration [µm]	Part No.	Type
MS4	5 (colour: blue)	534501	MS4-LFP-C
	40 (colour: white)	534502	MS4-LFP-E
MS6	5 (colour: blue)	534499	MS6-LFP-C
	40 (colour: white)	534500	MS6-LFP-E

### Special oil



Ordering data			
Scope of delivery		Part No.	Type
1 litre		152811	OFSW-32

Ordering data – Padlock LRVS-D			
	Weight [g]	Part No.	Type
	120	193786	LRVS-D