

Twin cylinders DPZC/DPZCJ



- 1 - Type discontinued
Available up until 2010

Twin cylinders DPZC/DPZCJ

Key features

FESTO

Variants

DPZC-...-S2

DPZCJ

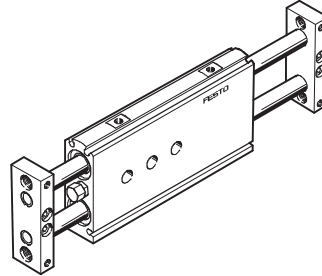
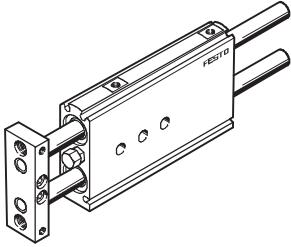

Mounting options

Horizontal mounting from above

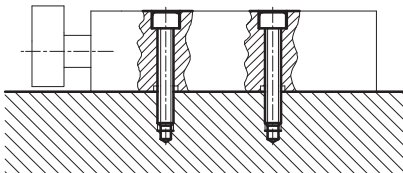

Horizontal mounting from below

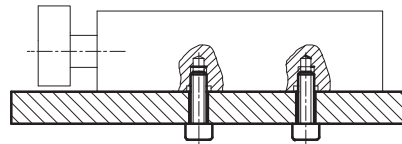

Side mounting from below

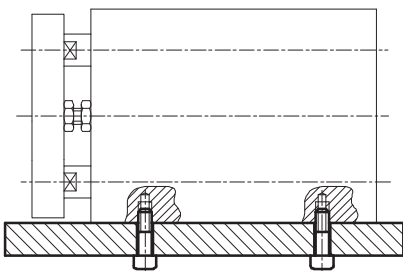

Stroke precision adjustment

- The screw allows adjustment of the standard strokes within a range of 10 mm.

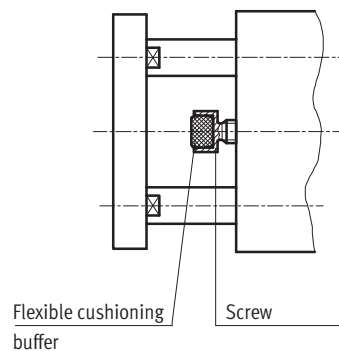

Twin cylinders DPZC/DPZCJ

Product range overview

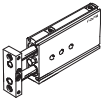
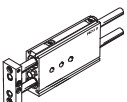
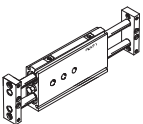
Function	Version	Type	Piston Ø [mm]	Stroke [mm]	Guide		Precision adjustment of end position		→ Page/ Internet	
					Plain-bearing guide GF	Recirculating ball bearing guide KF	Retracted end position	Advanced end position		
Double- acting	Basic version									
		DPZC Piston rods at one end	6, 10	10, 20, 30, 40, 50	■	■	■	-	6	
			16	10, 20, 30, 40, 50, 80, 100						
		DPZC-...-S2 Through piston rods for higher lateral forces and precision	6, 10	10, 20, 30, 40, 50	■	■	■	-	6	
			16	10, 20, 30, 40, 50, 80, 100						
	Yoke plate on through rods of cylinder									
	DPZCJ Through piston rods for higher lateral forces and precision	6, 10	10, 20, 30, 40, 50	■	■	■	■	15		
		16	10, 20, 30, 40, 50, 80, 100							

- 1 - Type discontinued
Available up until 2010

Twin cylinders DPZC/DPZCJ

Peripherals overview

FESTO

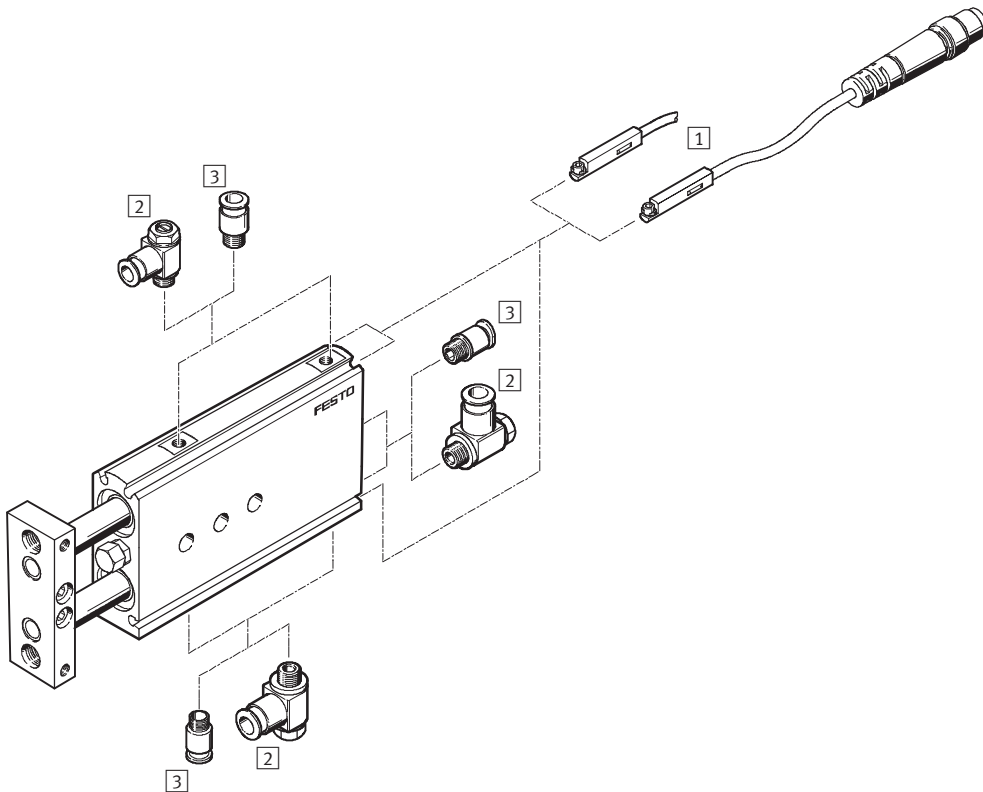

Accessories		
	Brief description	→ Page/Internet
1	Proximity sensor SME/SMT-10	22
2	One-way flow control valve GRLA	22
3	Push-in fitting QS	quick star
-	Centring sleeve ZBH	22

Twin cylinders DPZC/DPZCJ

Type codes

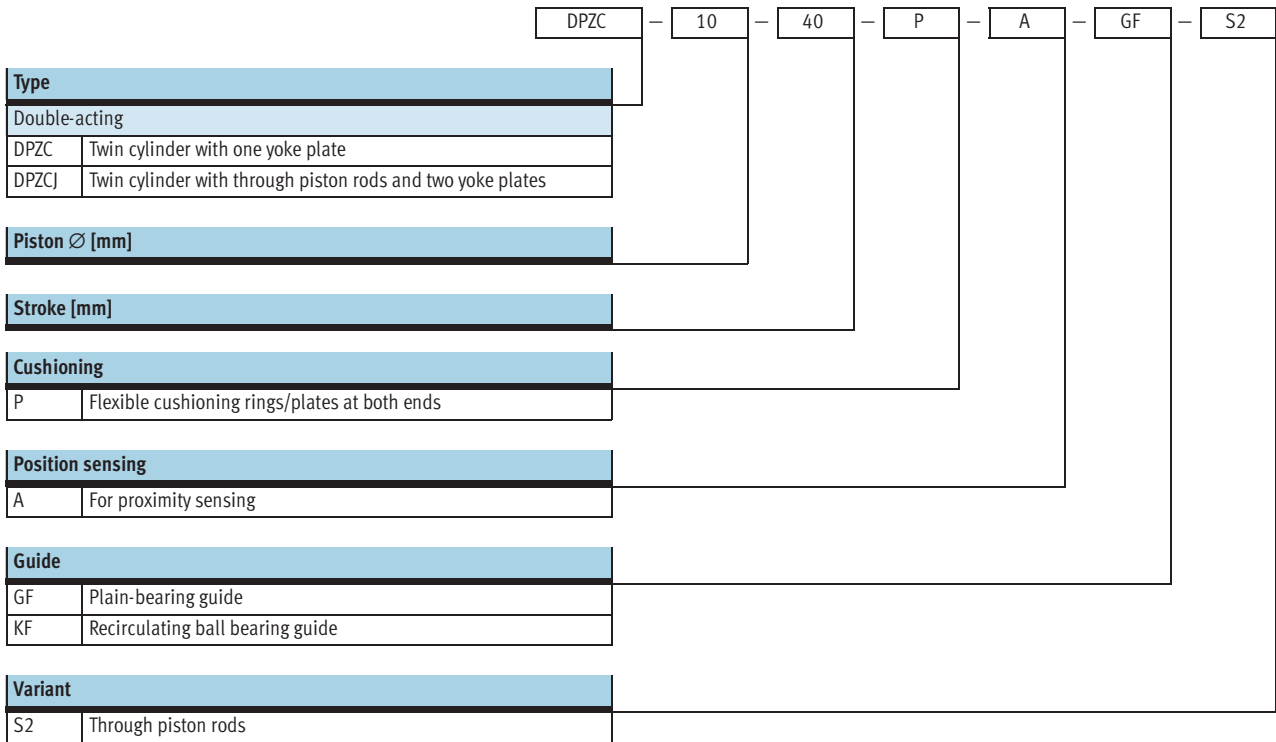

-  - Type discontinued
Available up until 2010

Twin cylinders DPZC

Technical data

FESTO

Function

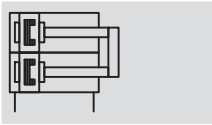

Variants



S2

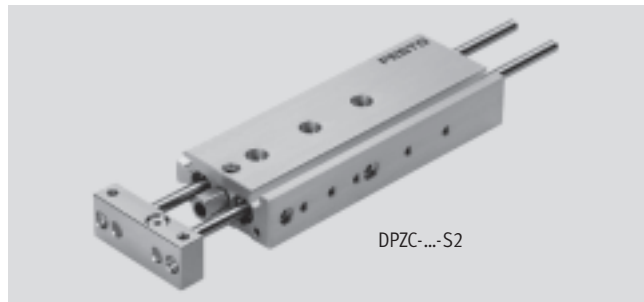
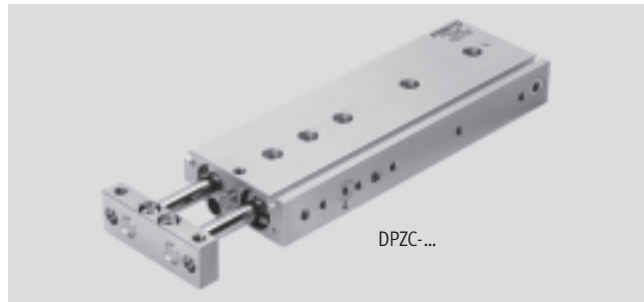

-  - Diameter
6, 10, 16 mm

-  - Stroke length
10 ... 100 mm

-  - www.festo.com

General technical data			
Piston \varnothing	6	10	16
Pneumatic connection	M3	M3	M5
Operating medium	Filtered compressed air, lubricated or unlubricated		
Operating pressure [bar]	GF	2.5 ... 10	1.5 ... 10
	KF	2 ... 10	1.5 ... 10
Constructional design	Parallel piston rods		
	Parallel piston rods with yoke		
Cushioning	Flexible cushioning rings/plates at both ends		
Position sensing	For proximity sensing		
Type of mounting	Via through-holes		
	Via female thread		
Mounting position	Any		
Protection against torsion/guide	Parallel piston rods/with plain-bearing or ball bearing guide		

Ambient conditions		
Variant	Plain-bearing guide GF	Recirculating ball bearing guide KF
Ambient temperature ¹⁾ [°C]	-5 ... +60	
Corrosion resistance class CRC ²⁾	2	-
ATEX	Specified types → www.festo.com	

1) Note operating range of proximity sensors

2) Corrosion resistance class 2 according to Festo standard 940 070

Components requiring moderate corrosion resistance. Externally visible parts with primarily decorative surface requirements which are in direct contact with a surrounding industrial atmosphere or media such as cooling or lubricating agents

Speeds [m/s] with maximum stroke length			
Piston \varnothing	6	10	16
Maximum speed	0.5	1.0	1.0
Minimum speed	0.05	0.05	0.05

Twin cylinders DPZC

Technical data

Forces [N] and impact energy [J]			
Piston Ø	6	10	16
Theoretical force at 6 bar, advancing	34	94	241
Theoretical force at 6 bar, retracting	19	60	181
Max. impact energy at the end positions	0.01	0.08	0.16

Permissible impact velocity:
$$v_{perm.} = \sqrt{\frac{2 \times E_{perm.}}{m_{dead} + m_{load}}}$$

$v_{perm.}$ Permissible impact velocity
 $E_{perm.}$ Max. impact energy
 m_{dead} Moving load (drive)
 m_{load} Moving work load

-  - Note

These specifications represent the maximum values which can be reached. Note the maximum permitted impact energy.

Maximum permissible load:
$$m_{load} = \frac{2 \times E_{perm.}}{v^2} - m_{dead}$$

Maximum permissible load m as a function of the impact speed v

Plain-bearing guide GF

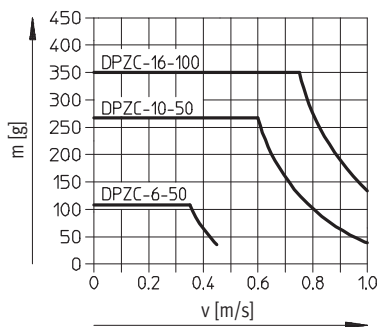

Recirculating ball bearing guide KF

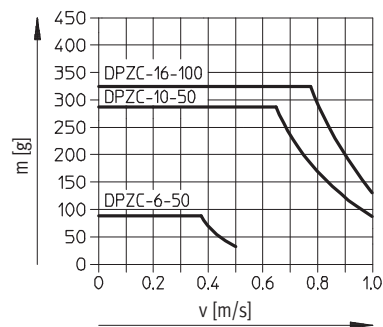

Through piston rod with plain-bearing guide GF

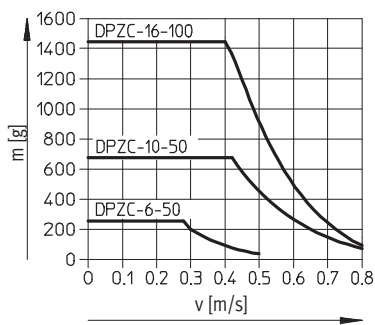

Through piston rod with recirculating ball bearing guide KF

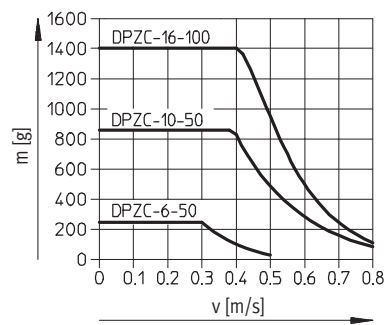

-  - Type discontinued
Available up until 2010

Twin cylinders DPZC

Technical data

FESTO

Weights						
Stroke [mm]	Piston Ø 6 mm		Piston Ø 10 mm		Piston Ø 16 mm	
	Piston rods at one end	Through piston rods	Piston rods at one end	Through piston rods	Piston rods at one end	Through piston rods
Product weight [g]						
10	75	90	120	160	230	320
20	105	130	160	210	290	410
30	140	170	200	260	350	500
40	170	210	240	320	420	580
50	200	250	280	370	480	670
80	-	-	-	-	670	930
100	-	-	-	-	800	1100
Moving load [g]						
10	37	46	59	82	127	177
20	39	48	63	87	135	185
30	41	50	65	91	143	193
40	43	52	72	96	150	200
50	45	54	76	100	158	208
80	-	-	-	-	182	216
100	-	-	-	-	198	224

Safety distances

Cylinder to cylinder

Safety distance X must be maintained when positioning cylinders together in series, as the stray fields of the switching magnets can result in faulty switching.

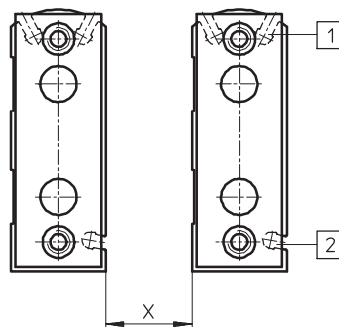

		1 Slot 1			2 Slot 2		
Piston Ø		6	10	16	6	10	16
Min. safety distance X [mm]	SME-10...	16	20	15	16	24	16
	SMT-10...	5	9	6	8	12	14

Twin cylinders DPZC

Technical data

Materials

Sectional view

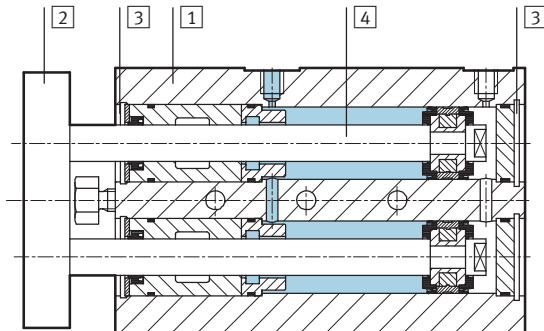

Twin cylinder	Plain-bearing guide GF	Recirculating ball bearing guide KF
1 Housing	Wrought aluminium alloy	Wrought aluminium alloy
2 Yoke plate	Tool steel	Tool steel
3 Plug cap	Wrought aluminium alloy	Wrought aluminium alloy
4 Piston rod	High-alloy stainless steel	Case-hardened steel
- Seals	Polyurethane, nitrile rubber	Polyurethane, nitrile rubber
Note on material	Free of copper, PTFE and silicone	Free of copper, PTFE and silicone

Maximum effective load F [N]

Plain-bearing guide GF and recirculating ball bearing guide KF

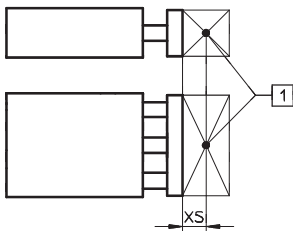

1 Centre of gravity of effective load

Piston rods at one end		Stroke [mm]						
Piston Ø [mm]	XS [mm]	10	20	30	40	50	80	100
6	GF	1.9	1.6	1.35	1.2	1.1	-	-
	KF	1.9	1.5	1.3	1.1	0.95	-	-
10	GF	4.5	3.9	3.4	3.0	2.7	-	-
	KF	5.2	4.3	3.7	3.3	2.9	-	-
16	GF	8.1	7.1	6.3	5.6	5.1	4.0	3.5
	KF	8.5	7.2	6.3	5.6	5.0	3.8	3.3

Through piston rods		Stroke [mm]						
Piston Ø [mm]	XS [mm]	10	20	30	40	50	80	100
6	GF	2.7	2.7	2.65	2.65	2.6	-	-
	KF	2.7	2.6	2.55	2.5	2.5	-	-
10	GF	6.7	6.7	6.7	6.6	6.6	-	-
	KF	9.2	9.0	8.8	8.7	8.6	-	-
16	GF	14.8	14.7	14.6	14.5	14.4	14.3	14.2
	KF	15.6	15.2	14.9	14.7	14.5	14.1	14.0

- 1 - Type discontinued
Available up until 2010

Twin cylinders DPZC

Technical data

FESTO

Permissible torque load M [Nm]

Plain-bearing guide GF and recirculating ball bearing guide KF

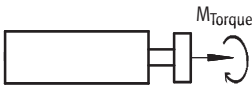

Piston rods at one end		Stroke [mm]							
		10	20	30	40	50	80	100	
Piston Ø [mm]	6	GF	0.015	0.013	0.011	0.009	0.008	–	–
	KF	0.015	0.012	0.010	0.009	0.008	–	–	
10	GF	0.045	0.039	0.034	0.030	0.027	–	–	
	KF	0.052	0.043	0.037	0.032	0.029	–	–	
16	GF	0.101	0.088	0.078	0.070	0.064	0.050	0.043	
	KF	0.106	0.090	0.079	0.070	0.063	0.048	0.041	

Through piston rods		Stroke [mm]							
		10	20	30	40	50	80	100	
Piston Ø [mm]	6	GF	0.021	0.021	0.021	0.021	0.021	–	–
	KF	0.022	0.021	0.020	0.020	0.020	–	–	
10	GF	0.067	0.067	0.067	0.066	0.066	–	–	
	KF	0.092	0.090	0.088	0.087	0.086	–	–	
16	GF	0.185	0.183	0.182	0.181	0.181	0.178	0.177	
	KF	0.195	0.190	0.186	0.183	0.181	0.176	0.175	

Torsional backlash p

Plain-bearing guide GF and recirculating ball bearing guide KF

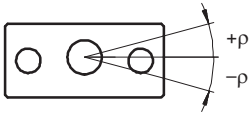

Piston Ø		6	10	16
In retracted state				
Torsional backlash [°]	GF	0.07	0.05	0.05
	KF	0.09	0.08	0.06
In advanced state with maximum stroke				
Torsional backlash [°]	GF	0.40	0.30	0.30
	KF	0.70	0.50	0.50

Deflection of piston rod

Graphs → 11

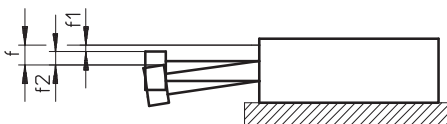

- $f = f_1 + f_2$
- f = Total deflection of piston rod
- f_1 = Deflection due to bearing backlash
- f_2 = Deflection due to lateral force

Twin cylinders DPZC

Technical data

Deflection f_1 due to bearing backlash as a function of the stroke l

Plain-bearing guide GF

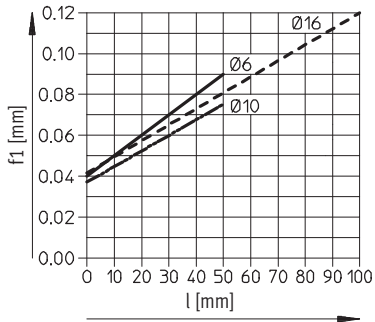

Recirculating ball bearing guide KF

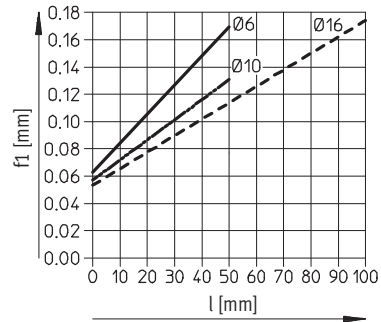

Through piston rod with plain-bearing guide GF

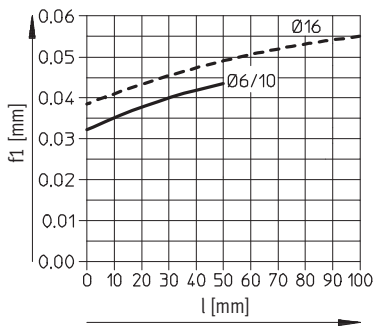

Through piston rod with recirculating ball bearing guide KF

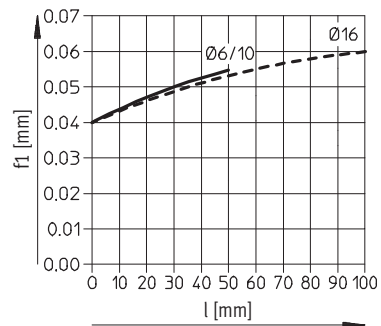

Deflection f_2 due to lateral force F_q as a function of the stroke

Piston \varnothing 6 mm

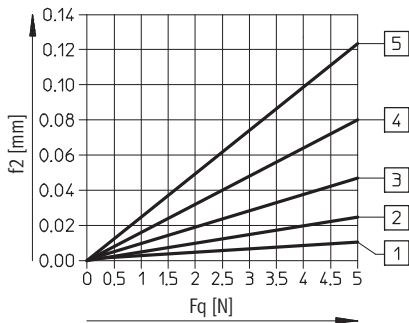

Piston \varnothing 10 mm

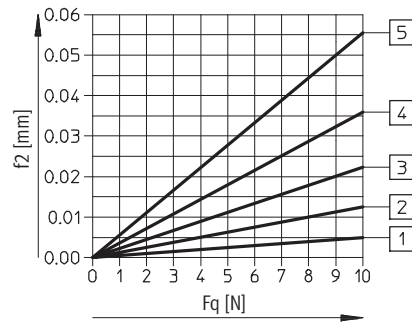

Piston \varnothing 16 mm

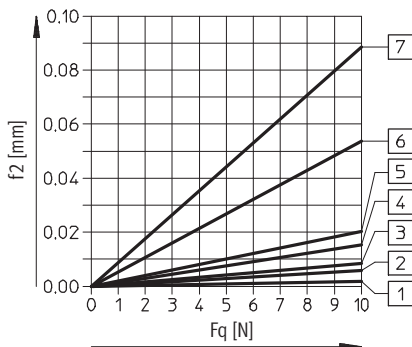

- 1 10 mm stroke
- 2 20 mm stroke
- 3 30 mm stroke
- 4 40 mm stroke
- 5 50 mm stroke
- 6 80 mm stroke
- 7 100 mm stroke

-  - Type discontinued
Available up until 2010

Twin cylinders DPZC

Technical data

FESTO

Dimensions – Basic version

Download CAD data → www.festo.com

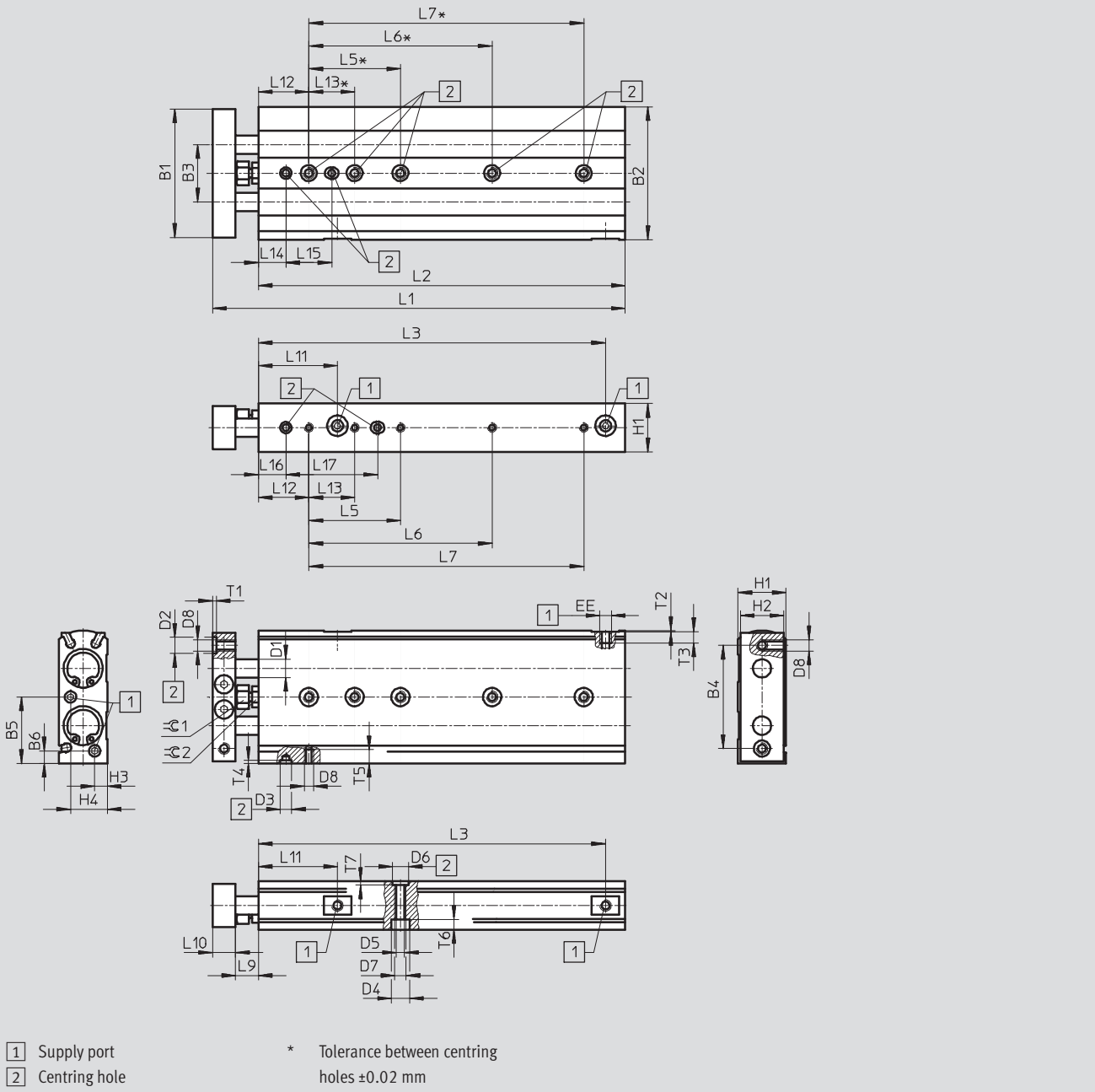

Dimensions – Varian

Download CAD data → www.festo.com

S2 – Through piston rods

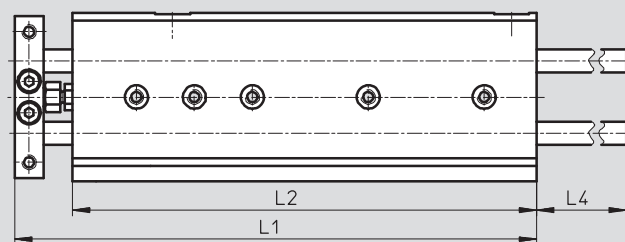

 Note

In the case of twin cylinders with through piston rods, the guide rods project beyond the edge of the housing when the unit is in its retracted end position. If the unit is

to be mounted on its end cap against a surface, a recess should be provided in this surface to allow the guide rods to move freely.

Twin cylinders DPZC

Technical data

∅ [mm]	B1	B2	B3	B4 ±0.1	B5	B6	D1 ∅		D2 ∅ H7	D3 ∅ H7	D4 ∅	D5 ∅	D6 ∅ H7
							GF	KF					
6	35	37	16	28	18.5	5	4h8	4h6	5	5	6	3.3	7
10	44	46	20	35	23	5	6h8	6h6	7	5	8	4.2	7
16	56	58	25	45	29	5.5	8h8	8h6	7	5	8	4.2	7

∅ [mm]	D7	D8	EE	H1	H2	H3	H4	L9	L10	L11	L12 ±0.1	L13 ±0.1	L14 ±0.1
10	M5	M4	M3	16	14	3.5	8	9.5	8	29	22	20	12
16	M5	M5	M5	21	19	5.5	16	10	10	34.5	22	20	12

∅ [mm]	L15	L16 ±0.1	L17	T1	T2	T3	T4	T5	T6	T7	≈C1	≈C2
10	20	12	36	1.6	0.5	4	1.3	5.5	4.5	1.6	8	7
16	20	12	40	1.6	0.5	5	1.3	6	4.5	1.6	9	8

∅ [mm]	Stroke [mm]	L1		L2		L3		L4	L5 ¹⁾ ±0.1		L6 ¹⁾ ±0.1		L7 ¹⁾ ±0.1
		Basic version	S2	Basic version	S2	Basic version	S2		Basic version	S2	Basic version	S2	
		6	10	73	88	56.5	71.5		49.2	48	26.5	-	
	20	83	98	66.5	81.5	59.2	58	36.5	40	40	-	-	-
	30	93	108	76.5	91.5	69.2	68	46.5	40	40	-	-	-
	40	103	118	86.5	101.5	79.2	78	56.5	40	40	-	-	-
	50	113	128	96.5	111.5	89.2	88	66.5	40	40	-	80	-
10	10	81	100.5	63.5	83	55.5	54	27.5	-	-	-	-	-
	20	91	110.5	73.5	93	65.5	64	37.5	-	-	-	-	-
	30	101	120.5	83.5	103	75.5	74	47.5	40	40	-	-	-
	40	111	130.5	93.5	113	85.5	84	57.5	40	40	-	-	-
	50	121	140.5	103.5	123	95.5	94	67.5	40	40	-	80	-
16	10	90	118.5	70	98.5	61.5	64	27	-	-	-	60	-
	20	100	128.5	80	108.5	71.5	74	37	40	40	-	-	-
	30	110	138.5	90	118.5	81.5	84	47	40	40	-	80	-
	40	120	148.5	100	128.5	91.5	94	57	40	40	-	80	-
	50	130	158.5	110	138.5	101.5	104	67	40	40	60	80	-
	80	160	188.5	140	168.5	131.5	134	97	40	40	80	80	-
	100	180	208.5	160	188.5	151.5	154	117	40	40	80	80	120

1) Tolerance between centring holes ±0.02 mm

-  - Type discontinued
Available up until 2010

Twin cylinders DPZC

Technical data

FESTO

Ordering data – Basic version						
Type	Piston Ø [mm]	Stroke [mm]	Plain-bearing guide GF		Recirculating ball bearing guide KF	
			Part No.	Type	Part No.	Type
	6	10	194 333	DPZC-6-10-P-A-GF	194 384	DPZC-6-10-P-A-KF
		20	194 334	DPZC-6-20-P-A-GF	194 385	DPZC-6-20-P-A-KF
		30	194 335	DPZC-6-30-P-A-GF	194 386	DPZC-6-30-P-A-KF
		40	194 336	DPZC-6-40-P-A-GF	194 387	DPZC-6-40-P-A-KF
		50	194 337	DPZC-6-50-P-A-GF	194 388	DPZC-6-50-P-A-KF
	10	10	194 338	DPZC-10-10-P-A-GF	194 389	DPZC-10-10-P-A-KF
		20	194 339	DPZC-10-20-P-A-GF	194 390	DPZC-10-20-P-A-KF
		30	194 340	DPZC-10-30-P-A-GF	194 391	DPZC-10-30-P-A-KF
		40	194 341	DPZC-10-40-P-A-GF	194 392	DPZC-10-40-P-A-KF
		50	194 342	DPZC-10-50-P-A-GF	194 393	DPZC-10-50-P-A-KF
	16	10	194 343	DPZC-16-10-P-A-GF	194 394	DPZC-16-10-P-A-KF
		20	194 344	DPZC-16-20-P-A-GF	194 395	DPZC-16-20-P-A-KF
		30	194 345	DPZC-16-30-P-A-GF	194 396	DPZC-16-30-P-A-KF
		40	194 346	DPZC-16-40-P-A-GF	194 397	DPZC-16-40-P-A-KF
		50	194 347	DPZC-16-50-P-A-GF	194 398	DPZC-16-50-P-A-KF
80		194 348	DPZC-16-80-P-A-GF	194 399	DPZC-16-80-P-A-KF	
100		194 349	DPZC-16-100-P-A-GF	194 400	DPZC-16-100-P-A-KF	

Ordering data – Variant						
Type	Piston Ø [mm]	Stroke [mm]	Plain-bearing guide GF		Recirculating ball bearing guide KF	
			Part No.	Type	Part No.	Type
S2 – Through piston rods						
	6	10	194 350	DPZC-6-10-P-A-GF-S2	194 401	DPZC-6-10-P-A-KF-S2
		20	194 351	DPZC-6-20-P-A-GF-S2	194 402	DPZC-6-20-P-A-KF-S2
		30	194 352	DPZC-6-30-P-A-GF-S2	194 403	DPZC-6-30-P-A-KF-S2
		40	194 353	DPZC-6-40-P-A-GF-S2	194 404	DPZC-6-40-P-A-KF-S2
		50	194 354	DPZC-6-50-P-A-GF-S2	194 405	DPZC-6-50-P-A-KF-S2
	10	10	194 355	DPZC-10-10-P-A-GF-S2	194 406	DPZC-10-10-P-A-KF-S2
		20	194 356	DPZC-10-20-P-A-GF-S2	194 407	DPZC-10-20-P-A-KF-S2
		30	194 357	DPZC-10-30-P-A-GF-S2	194 408	DPZC-10-30-P-A-KF-S2
		40	194 358	DPZC-10-40-P-A-GF-S2	194 409	DPZC-10-40-P-A-KF-S2
		50	194 359	DPZC-10-50-P-A-GF-S2	194 410	DPZC-10-50-P-A-KF-S2
	16	10	194 360	DPZC-16-10-P-A-GF-S2	194 411	DPZC-16-10-P-A-KF-S2
		20	194 361	DPZC-16-20-P-A-GF-S2	194 412	DPZC-16-20-P-A-KF-S2
		30	194 362	DPZC-16-30-P-A-GF-S2	194 413	DPZC-16-30-P-A-KF-S2
		40	194 363	DPZC-16-40-P-A-GF-S2	194 414	DPZC-16-40-P-A-KF-S2
		50	194 364	DPZC-16-50-P-A-GF-S2	194 415	DPZC-16-50-P-A-KF-S2
80		194 365	DPZC-16-80-P-A-GF-S2	194 416	DPZC-16-80-P-A-KF-S2	
100		194 366	DPZC-16-100-P-A-GF-S2	194 417	DPZC-16-100-P-A-KF-S2	

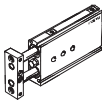
Centring sleeves included in scope of delivery			
DPZC	Piston Ø [mm]	Centring sleeves	
	6	4x ZBH-5	2x ZBH-7
	10	2x ZBH-5	4x ZBH-7
	16	2x ZBH-5	4x ZBH-7

Twin cylinders DPZCJ

Technical data

Function

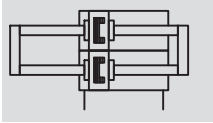

-  - Diameter
6, 10, 16 mm

-  - Stroke length
10 ... 100 mm

-  - www.festo.com

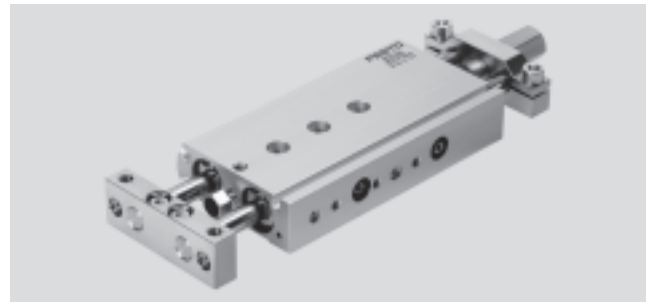

General technical data			
Piston Ø	6	10	16
Pneumatic connection	M3	M3	M5
Operating medium	Filtered compressed air, lubricated or unlubricated		
Operating pressure [bar]	GF	2.5 ... 10	1.5 ... 10
	KF	2 ... 10	1.5 ... 10
Constructional design	Parallel piston rods		
	Parallel piston rods with yoke		
Cushioning	Flexible cushioning rings/plates at both ends		
Position sensing	For proximity sensing		
Type of mounting	Via through-holes		
	Via female thread		
Mounting position	Any		
Protection against torsion/guide	Parallel piston rods/with plain-bearing or ball bearing guide		

Ambient conditions		
Variant	Plain-bearing guide GF	Recirculating ball bearing guide KF
Ambient temperature ¹⁾ [°C]	-5 ... +60	
Corrosion resistance class CRC ²⁾	2	-
ATEX	Specified types → www.festo.com	

1) Note operating range of proximity sensors

2) Corrosion resistance class 2 according to Festo standard 940 070

Components requiring moderate corrosion resistance. Externally visible parts with primarily decorative surface requirements which are in direct contact with a surrounding industrial atmosphere or media such as cooling or lubricating agents

Speeds [m/s] with maximum stroke length			
Piston Ø	6	10	16
Maximum speed	0.5	0.8	0.8
Minimum speed	0.05	0.05	0.05

Forces [N]			
Piston Ø	6	10	16
Theoretical force at 6 bar, advancing and retracting	19	60	181

-  - Type discontinued
Available up until 2010

Twin cylinders DPZCJ

Technical data

FESTO

Impact energy [J]			
Piston Ø	6	10	16
Max. impact energy at the end positions	0.016	0.08	0.16

Permissible impact velocity:

$$v_{\text{perm.}} = \sqrt{\frac{2 \times E_{\text{perm.}}}{m_{\text{dead}} + m_{\text{load}}}}$$

$v_{\text{perm.}}$ Permissible impact velocity
 $E_{\text{perm.}}$ Max. impact energy
 m_{dead} Moving load (drive)
 m_{load} Moving work load



Note

These specifications represent the maximum values which can be reached. Note the maximum permitted impact energy.

Maximum permissible load:

$$m_{\text{load}} = \frac{2 \times E_{\text{perm.}}}{v^2} - m_{\text{dead}}$$

Maximum permissible load m as a function of the impact speed v

Plain-bearing guide GF

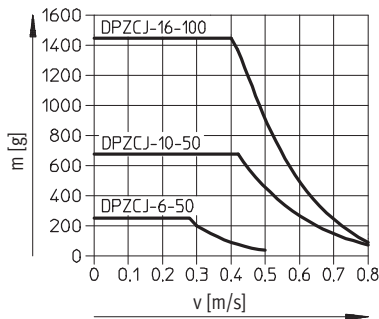

Recirculating ball bearing guide KF

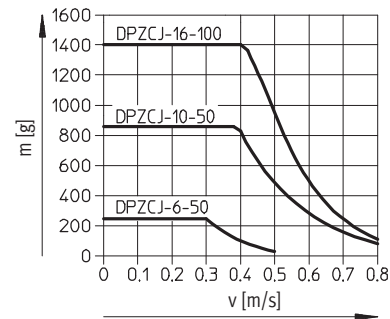

Weights			
Stroke [mm]	Piston Ø 6 mm	Piston Ø 10 mm	Piston Ø 16 mm
Product weight [g]			
10	130	210	410
20	170	260	500
30	210	310	580
40	250	360	670
50	290	410	760
80	-	-	1020
100	-	-	1200
Moving load [g]			
10	87	128	256
20	91	136	272
30	95	145	288
40	99	154	304
50	103	163	320
80	-	-	367
100	-	-	398

Twin cylinders DPZCJ

Technical data

Safety distances

Cylinder to cylinder

Safety distance X must be maintained when positioning cylinders together in series, as the stray fields of the switching magnets can result in faulty switching.

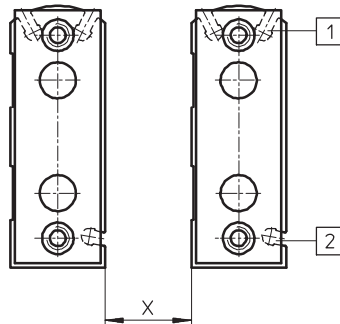

	1 Slot 1			2 Slot 2			
	Piston \varnothing	6	10	16	6	10	16
Min. safety distance X [mm]	SME-10...	16	20	15	16	24	16
	SMT-10...	5	9	6	8	12	14

Materials

Sectional view

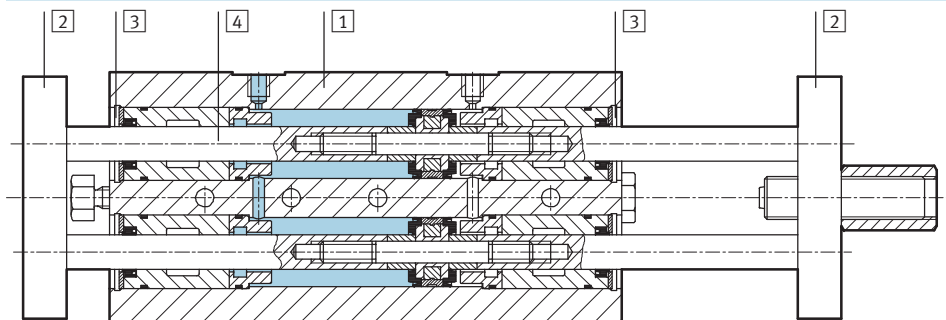

Twin cylinder	Plain-bearing guide GF	Recirculating ball bearing guide KF
1 Housing	Wrought aluminium alloy	Wrought aluminium alloy
2 Yoke plate	Tool steel	Tool steel
3 Plug cap	Wrought aluminium alloy	Wrought aluminium alloy
4 Piston rod	High-alloy stainless steel	Case-hardened steel
- Seals	Polyurethane, nitrile rubber	Polyurethane, nitrile rubber
Note on material	Free of copper, PTFE and silicone	Free of copper, PTFE and silicone

Twin cylinders DPZCJ

Technical data

Maximum effective load F [N]

Plain-bearing guide GF and recirculating ball bearing guide KF

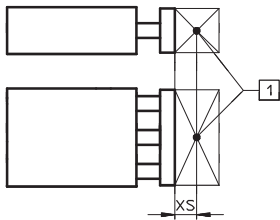

1 Centre of gravity of effective load

Piston Ø [mm]	XS [mm]	Stroke [mm]							
		10	20	30	40	50	80	100	
6	GF	0	2.7	2.7	2.65	2.65	2.6	-	-
	KF		2.7	2.6	2.55	2.5	2.5	-	-
10	GF	0	6.7	6.7	6.7	6.6	6.6	-	-
	KF		9.2	9.0	8.8	8.7	8.6	-	-
16	GF	0	14.8	14.7	14.6	14.5	14.4	14.3	14.2
	KF		15.6	15.2	14.9	14.7	14.5	14.1	14.0

Permissible torque load M [Nm]

Plain-bearing guide GF and recirculating ball bearing guide KF

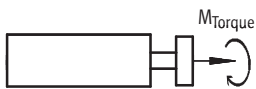

Piston Ø [mm]	Stroke [mm]	Stroke [mm]						
		10	20	30	40	50	80	100
6	GF	0.021	0.021	0.021	0.021	0.021	-	-
	KF	0.022	0.021	0.020	0.020	0.020	-	-
10	GF	0.067	0.067	0.067	0.066	0.066	-	-
	KF	0.092	0.090	0.088	0.087	0.086	-	-
16	GF	0.185	0.183	0.182	0.181	0.181	0.178	0.177
	KF	0.195	0.190	0.186	0.183	0.181	0.176	0.175

Torsional backlash p

Plain-bearing guide GF and recirculating ball bearing guide KF

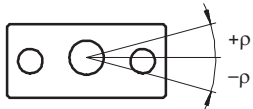

Piston Ø		6	10	16
In retracted state				
Torsional backlash [°]	GF	0.07	0.05	0.05
	KF	0.09	0.08	0.06
In advanced state with maximum stroke				
Torsional backlash [°]	GF	0.25	0.20	0.20
	KF	0.30	0.25	0.20

Twin cylinders DPZCJ

Technical data

Deflection of piston rod

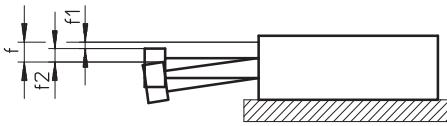

$$f = f_1 + f_2$$

f = Total deflection of piston rod

f₁ = Deflection due to bearing backlash

f₂ = Deflection due to lateral force

Deflection f₁ due to bearing backlash as a function of the stroke l

Plain-bearing guide GF

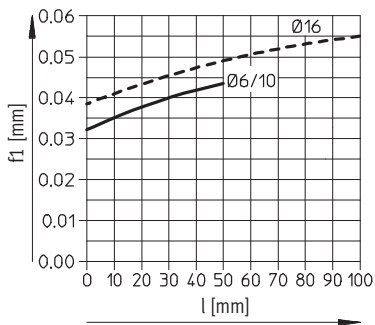

Recirculating ball bearing guide KF

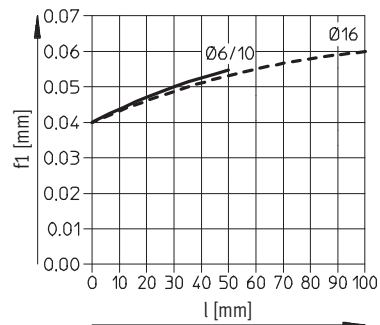

Deflection f₂ due to lateral force F_q as a function of the stroke

Piston Ø 6 mm

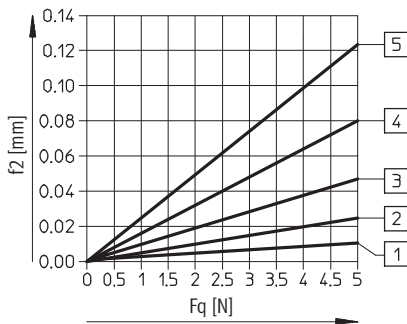

Piston Ø 10 mm

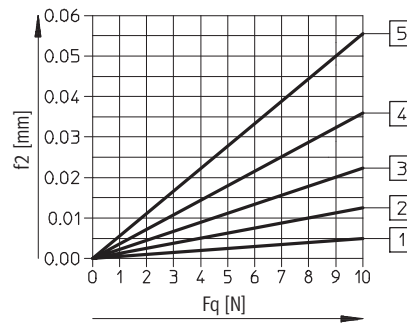

Piston Ø 16 mm

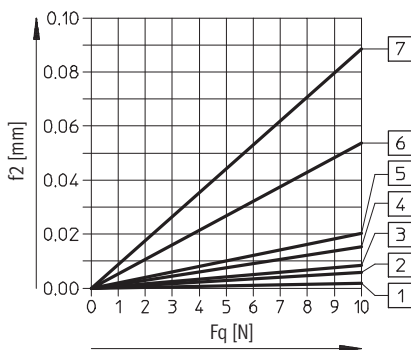

- 1 10 mm stroke
- 2 20 mm stroke
- 3 30 mm stroke
- 4 40 mm stroke
- 5 50 mm stroke
- 6 80 mm stroke
- 7 100 mm stroke

- 1 - Type discontinued
Available up until 2010

Twin cylinders DPZCJ

Technical data

FESTO

Dimensions

Download CAD data → www.festo.com

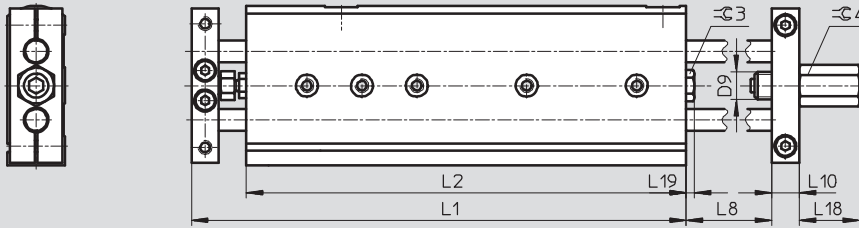

Ø	Stroke	D9	L1	L2	L8	L10	L18	L19	Ø3	Ø4
[mm]	[mm]									
6	10	M8x1	88	71.5	18.5	8	15	3	7	10
	20		98	81.5	28.5					
	30		108	91.5	38.5					
	40		118	101.5	48.5					
	50		128	111.5	58.5					
10	10		100.5	83	19.5					
	20		110.5	93	29.5					
	30		120.5	103	39.5					
	40		130.5	113	49.5					
	50		140.5	123	59.5					
16	10	M10x1	118.5	98.5	20	10	22	3	10	13
	20		128.5	108.5	30					
	30		138.5	118.5	40					
	40		148.5	128.5	50					
	50		158.5	138.5	60					
	80		188.5	168.5	90					
	100		208.5	188.5	110					

 Type discontinued
Available up until 2010

FESTO

Twin cylinders DPZCJ

Technical data

Ordering data						
Type	Piston Ø [mm]	Stroke [mm]	Plain-bearing guide GF		Recirculating ball bearing guide KF	
			Part No.	Type	Part No.	Type
	6	10	194 367	DPZCJ-6-10-P-A-GF	194 418	DPZCJ-6-10-P-A-KF
		20	194 368	DPZCJ-6-20-P-A-GF	194 419	DPZCJ-6-20-P-A-KF
		30	194 369	DPZCJ-6-30-P-A-GF	194 420	DPZCJ-6-30-P-A-KF
		40	194 370	DPZCJ-6-40-P-A-GF	194 421	DPZCJ-6-40-P-A-KF
		50	194 371	DPZCJ-6-50-P-A-GF	194 422	DPZCJ-6-50-P-A-KF
	10	10	194 372	DPZCJ-10-10-P-A-GF	194 423	DPZCJ-10-10-P-A-KF
		20	194 373	DPZCJ-10-20-P-A-GF	194 424	DPZCJ-10-20-P-A-KF
		30	194 374	DPZCJ-10-30-P-A-GF	194 425	DPZCJ-10-30-P-A-KF
		40	194 375	DPZCJ-10-40-P-A-GF	194 426	DPZCJ-10-40-P-A-KF
		50	194 376	DPZCJ-10-50-P-A-GF	194 427	DPZCJ-10-50-P-A-KF
	16	10	194 377	DPZCJ-16-10-P-A-GF	194 428	DPZCJ-16-10-P-A-KF
		20	194 378	DPZCJ-16-20-P-A-GF	194 429	DPZCJ-16-20-P-A-KF
		30	194 379	DPZCJ-16-30-P-A-GF	194 430	DPZCJ-16-30-P-A-KF
		40	194 380	DPZCJ-16-40-P-A-GF	194 431	DPZCJ-16-40-P-A-KF
		50	194 381	DPZCJ-16-50-P-A-GF	194 432	DPZCJ-16-50-P-A-KF
		80	194 382	DPZCJ-16-80-P-A-GF	194 433	DPZCJ-16-80-P-A-KF
		100	194 383	DPZCJ-16-100-P-A-GF	194 434	DPZCJ-16-100-P-A-KF

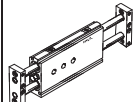
Centring sleeves included in scope of delivery		
DPZCJ	Piston Ø [mm]	Centring sleeves
	6	4x ZBH-5 2x ZBH-7
	10	2x ZBH-5 4x ZBH-7
	16	2x ZBH-5 4x ZBH-7

- 1 - Type discontinued
Available up until 2010



FESTO



Twin cylinders DPZC/DPZCJ



Accessories

Ordering data – Centring sleeves ZBH			Technical data → Internet: zbh		
	For Ø [mm]	Material	Part No.	Type	PU ¹⁾
	6, 10, 16	Stainless steel	189 652	ZBH-5	10
		Free of copper, PTFE and silicone	186 717	ZBH-7	10

1) Packaging unit quantity

Ordering data – Proximity sensors for C-slot, magneto-resistive					Technical data → Internet: smt	
	Type of mounting	Switch output	Electrical connection, connection direction	Cable length [m]	Part No.	Type
N/O contact						
	Insertable in the slot from above, flush with cylinder profile	PNP	Cable, 3-wire, in-line	2.5	525 915	SMT-10F-PS-24V-K2,5L-OE
			Plug M8x1, 3-pin, in-line	0.3	525 916	SMT-10F-PS-24V-K0,3L-M8D
			Plug M8x1, 3-pin, lateral	0.3	526 675	SMT-10F-PS-24V-K0,3Q-M8D
	Insertable in the slot lengthwise	PNP	Plug M8x1, 3-pin, in-line	0.3	173 220	SMT-10-PS-SL-LED-24
			Cable, 3-wire, in-line	2.5	173 218	SMT-10-PS-KL-LED-24

Ordering data – Proximity sensors for C-slot, magnetic reed					Technical data → Internet: sme	
	Type of mounting	Switch output	Electrical connection, connection direction	Cable length [m]	Part No.	Type
N/O contact						
	Insertable in the slot from above, flush with cylinder profile	Contacting	Plug M8x1, 3-pin, in-line	0.3	525 914	SME-10F-DS-24V-K0,3L-M8D
			Cable, 3-wire, in-line	2.5	525 913	SME-10F-DS-24V-K2,5L-OE
			Cable, 2-wire, in-line	2.5	526 672	SME-10F-ZS-24V-K2,5L-OE
	Insertable in the slot lengthwise	Contacting	Plug M8x1, 3-pin, in-line	0.3	173 212	SME-10-SL-LED-24
			Cable, 3-wire, in-line	2.5	173 210	SME-10-KL-LED-24

Ordering data – Connecting cables				Technical data → Internet: nebu	
	Electrical connection, left	Electrical connection, right	Cable length [m]	Part No.	Type
	Straight socket, M8x1, 3-pin	Cable, open end, 3-wire	2.5	541 333	NEBU-M8G3-K-2.5-LE3
			5	541 334	NEBU-M8G3-K-5-LE3
	Angled socket, M8x1, 3-pin	Cable, open end, 3-wire	2.5	541 338	NEBU-M8W3-K-2.5-LE3
			5	541 341	NEBU-M8W3-K-5-LE3

Ordering data – One-way flow control valves				Technical data → Internet: grla	
	Connection	For tubing O.D.	Material	Part No.	Type
	Thread				
For exhaust air					
	M3	3	Metal design	175 041	GRLA-M3-QS-3
	M5	3		193 137	GRLA-M5-QS-3-D
		4		193 138	GRLA-M5-QS-4-D
		6		193 139	GRLA-M5-QS-6-D