

AS-interface® components

FESTO



AS-interface® components

Overview of AS-interface

FESTO

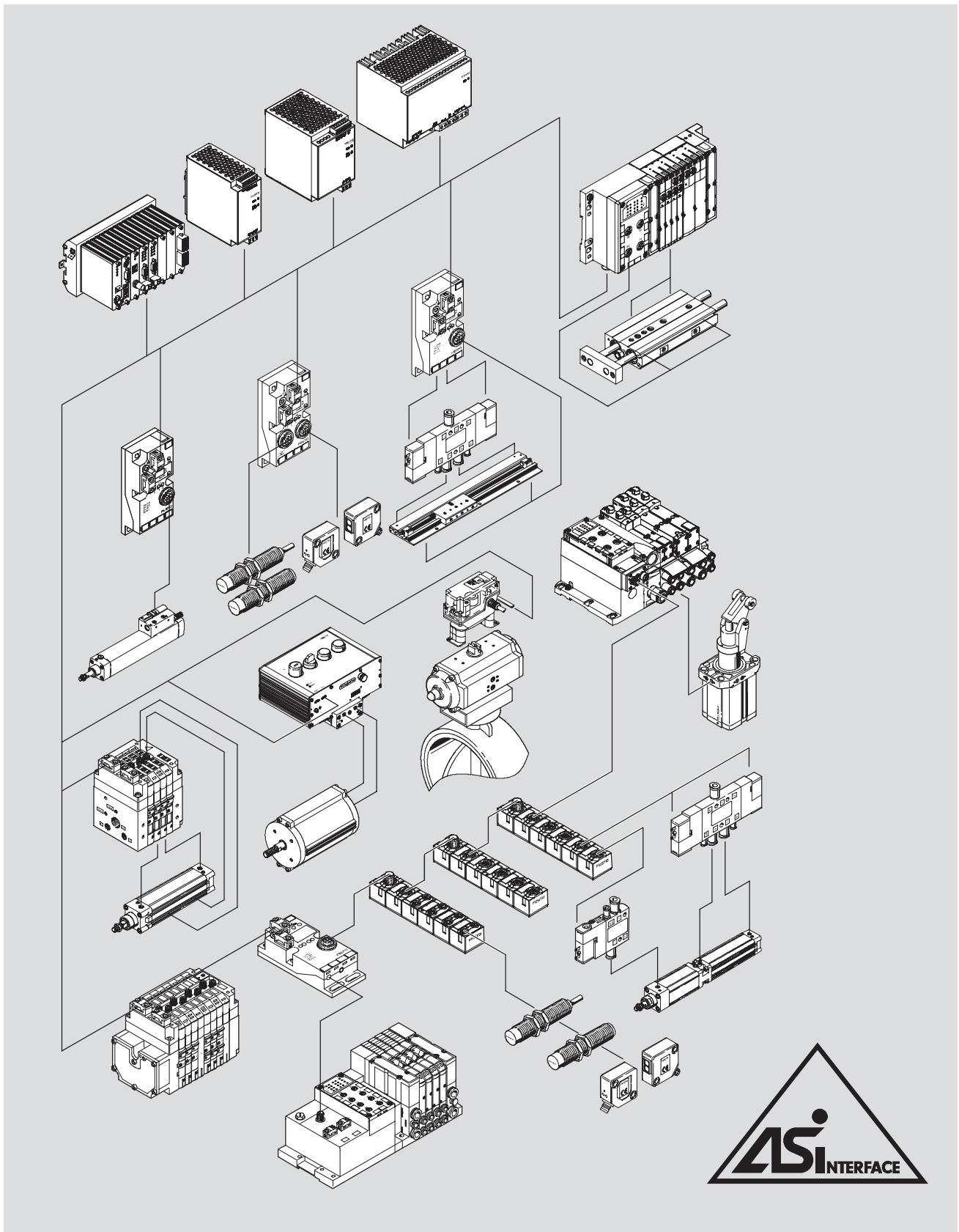

Basic principles and features of the bus system

Introduction

AS-interface is a non-proprietary, open installation system with a large and growing share of the market at the lowest level of the decentralised production and process automation hierarchy.

The non-proprietary and open characteristics of the system are guaranteed by the European standard EN 50295 and the international

standard IEC 62026-2. Certified products bear the logo of the AS-International Association.

The AS-International Association and its affiliated organisations represent the interests of all manufacturers with an interest in the AS-interface.

Design

The AS-interface system permits the transfer of power and data using a single cable. The advanced technology used to connect stations to the yellow cable and the low connection costs mean that even stations with a small number of inputs and outputs (max. 8 inputs and 8 outputs per valve terminal with two chips) can be networked. Reductions in installation costs of between 26% and 40% have been demonstrated depending on the system type. This solution is an ideal low-cost option for connecting individual or

small groups of actuators, valves and sensors to a master controller. New developments as per Specification V2.1 published at the start of 2000 such as the parameterisable profile 7.4 or the AS-interface Safety at Work concept opened the way for new areas of application and facilitated considerably more efficient installation and networking concepts in many instances. Specification V3.0 published in 2005 represents another giant leap forward, facilitating convenient activation of

analogue I/O, complex slaves or serial text and data transfer, for example.

- Slaves as per Specifications V2.0 and V2.1 will also run under V3.0 – the system is fully downwards compatible. Benefits of AS-interface Specification V3.0:
- All of the benefits of the simple installation system since Specification V2.0 are retained
- Up to 400% more I/Os per master
- Improved peripheral error diagnostics
- More functions within Specifications V2.1 and V3.0, e.g. easy integration of complex 16-bit slaves,

fast analogue modules, DTM integration, asynchronous serial protocol, safety slaves

- Slave profiles for specific functions as well as interchangeability. Mix of different vendors and products, e.g. for parameters or communication services

AS-interface with A/B mode gives you 100% more. In A/B mode, each slave address is used twice. An output bit is used for A/B address differentiation (see table for case distinctions). The cycle time for pneumatic chains is generally more than adequate.

Specification Version	Inputs	Outputs	Bus cycle (ms)	No. of slaves, digital	No. of slaves, analogue	Σ I/O
2.0	4/4	4	5	31	31	248
2.1	4	3	10	62	31	434
3.0	4/8	4/8	20	62	62	992

Master-slave principle

- Non-proprietary
- No restrictions in terms of cable layout and/or topology
- Data and power via a single two-wire cable
- Immune to interference
- Medium: unshielded cable 2x 1.5 mm²
- With 31 slaves, max. 4 inputs and 4 outputs per slave
- Data and power supply for up to 8 outputs per AS-interface string

- With 62 slaves, max. 4 inputs and 3 outputs per slave (A/B mode as per Specification V2.1)
- Modules for control cabinets (IP20) and harsh industrial environments (IP65, IP67)
- With 31 slaves, 4 analogue inputs or outputs per slave
- Profile 7.3: analogue values (16 bits) per slave (as per Specification V2.1)

- Profile 7.4: parameterisable communication profile, e.g. 16x 16 bits per slave (as per Specification V2.1)
- Profile 7.A.7 allows 4 bits for digital inputs and 4 bits for digital outputs on just one A/B slave. The 4 outputs are transmitted in two A/B bus cycles of 2 bits each. This extends the cycle time (in the worst-case scenario) to 20 ms.

- Insulation displacement technology
- Cable length 100 m, can be extended to up to 200 m through the use of an extension plug and to up to 500 m through the use of repeaters, etc.
- Highly effective error control
- Simple commissioning
- Electronic address selection via the bus connection



Note

Slaves to Specification V3.0 require a master to Specification V3.0.

AS-interface® components

Overview of AS-interface

FESTO

Basic features

Simple connection technology

- One cable for power and data
- Cable profile prevents polarity reversal
- Error control means there is no need for screening
- Insulation displacement connection technology guarantees Festo plug and work™
- Alternative bus connection technology M12, 4-pin (standardised)

Ideal for pneumatic applications

Local control of small groups of actuators or individual distributed actuators covering an extensive area with

- short tubing lengths,
- high cycle rates,
- low air consumption.

Installation and communication are carried out via AS-interface components.

A powerful system component

AS-interface is clearly subordinate to the fieldbuses already in use and is therefore less a competing product and more a technically necessary and economically advisable add-on.

Everything from a single source

Festo is your single source for the AS-interface. This means

- one contact person,
- competent solutions from the market leader,
- convenient ordering system,
- complete delivery service,
- co-ordinated solutions for motion and control,
- worldwide service round the clock.

Optimised cycle rates

Decentralised solutions at the AS-interface permit optimised electro-pneumatic control loop systems: valve response times and optimum pairings of cylinder diameter and stroke save up to

- 20% cycle time with standard components
- 30% cycle time with fast switching valves
- 40% installation costs
- 50% air consumption/flow rate

Product range overview

Drives

Intelligent drives DNCV with integrated valve, sensor and diagnostic module

- Actuators for the process industry
- Quarter turn actuators DRD (Copar)
- Linear valve actuators DLP (Copac)

Local controllers for process actuators and outdoor use

Valves

- A universal solution from the individual valve interface up to the compact solution with 8 valves

- Integrated inputs on individual valve interfaces and valve terminals CPV, CPA, MPA and VTSA/VTSA-F

- More inputs thanks to 4-fold and 8-fold input modules

- On request: Application-specific valves and integration solutions

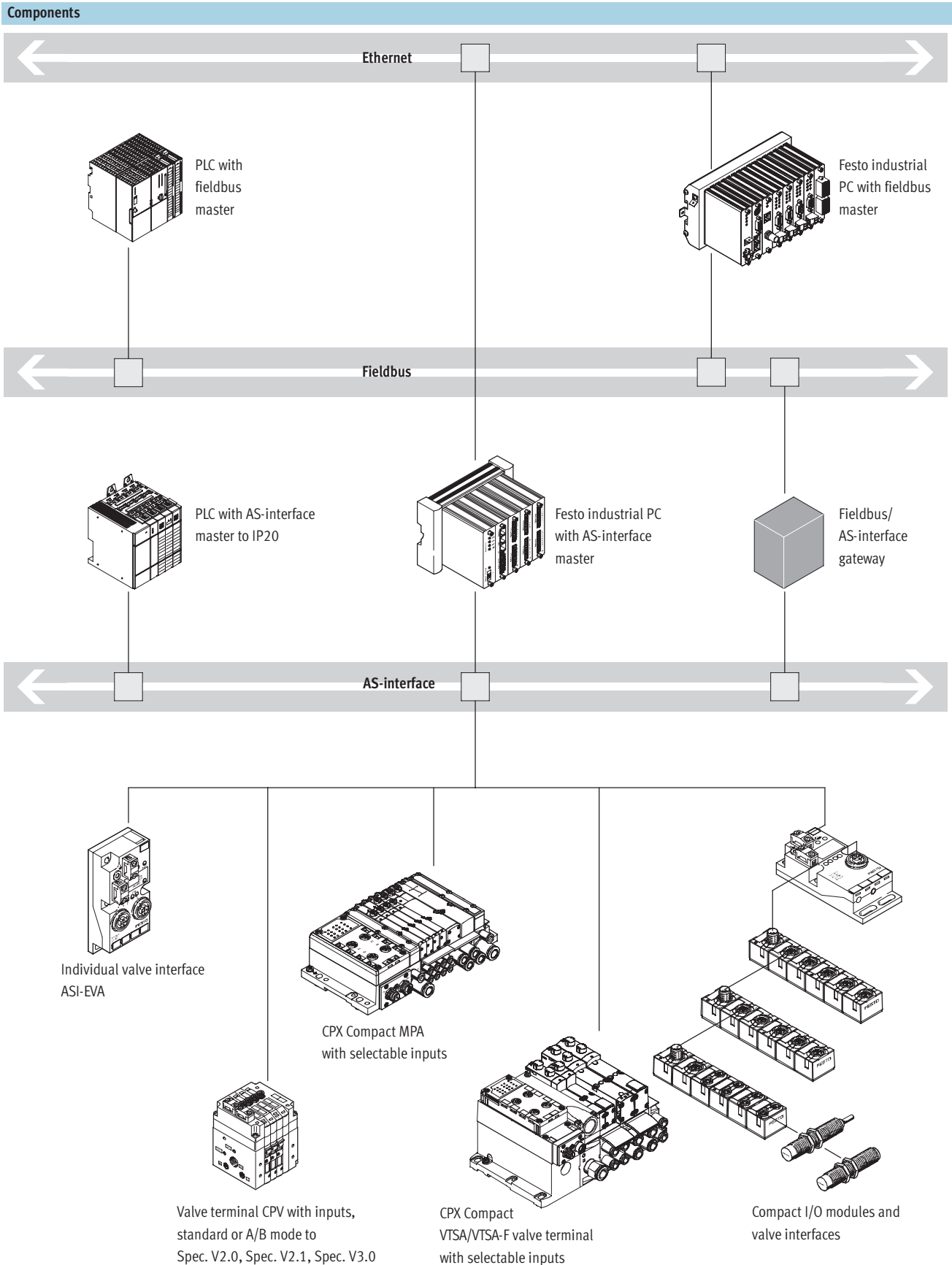

Application examples

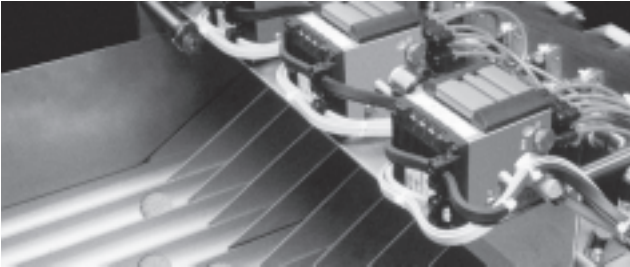

Sorting

Valve terminals MPA, VTSA/VTSA-F, CPV and CPA:
Compact Performance is synonymous with high performance and low

weight. Mounting close to the drives simplifies installation, saves compressed air and increases the cycle rates.



Conveyor technology

Individually distributed drives and sensors covering an extensive area are common features of conveyor systems. The AS-interface is particularly suited to systems of this type.

Individual valve interfaces ASI-EVA or compact I/O modules support the direct connection of one or two valves of any size and up to 4 sensors to the AS-interface.

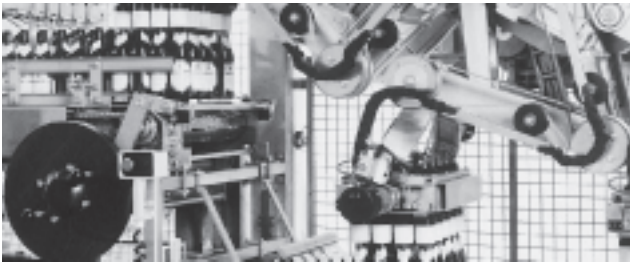

Packaging

More complex machines frequently require decentralised installation concepts within the system in order to achieve an efficient electrical installation.

The AS-interface controls complex modules and upstream functions such as packaging in this picture.

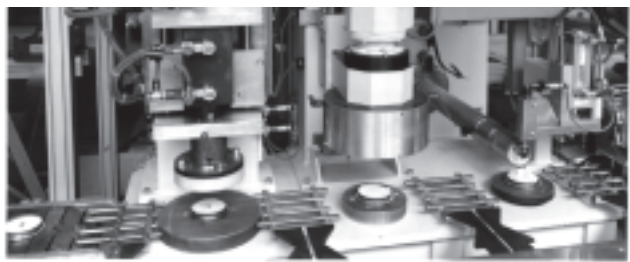

Assembling

Assembly, moving, handling: this often means rapid-fire sequences, tight installation spaces and the need for reduced weight.

Compact I/O modules, valve terminals and matching drives provide the optimum solution here.



Process engineering

Water treatment
Automation and decentralised intelligence are innovative features of newer systems. Festo's valve actuators for the process industry are controlled via the AS-interface in the temperature range of -25 to +85 °C using the local controller DLP and the sensor box DAPZ.

The ASI-EVA or a compact I/O module is suitable for all valves with Namur interface. The VTSA/VTSA-F valve terminal provides new scope for flow processes in 24-hour non-stop mode. Vertical pressure shut-off plates enable valve replacement under pressure (hot-swap) and thus avoid downtime.

Masters and accessories

Master to IP20

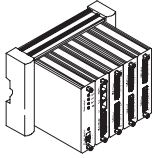

- PS1 industrial PC from Festo to IP20 with up to 2 AS-interface masters CP92, can be mounted on an H-rail
- Standard or A/B mode according to Specification V2.1
- Does not support Specification V3.0

- CPU
- Digital and analogue inputs/ outputs
- Ethernet interface
- Profibus interface

- Minimum order volume:
- Busboard PS1-BP50-12,5W-5SLOT Part No. 160 817
 - AS-interface master PS1-CP92-ASI Part No. 537 231
 - Processor PS1-HC20-60-FST Part No. 549 175

Accessories

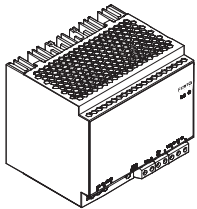
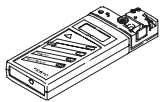

- Addressing device with user-friendly operating and diagnostic functions for the entire AS-interface, for example to perform the following tasks in a fully installed network:
 - change addresses
 - set outputs
 - read inputs
 - and many more

- Power supply unit for AS-interface
- Primary switched mode modular power supply
- Compact, modular and energy-saving power supply system for AS-interface – with integrated earth-fault monitoring system. AS-i load: 4.8 A. Optional auxiliary power supply 24 VDC, load: 5 or 10 A

- Installation accessories for installing the flat cable

Slaves

Drives

Intelligent drives DNCV:

- Integrated solution with diagnostic module

Actuators for the process industry
Quarter turn actuators DRD (Copar)
Linear valve actuators DLP (Copar)

- Local controllers for actuators in outdoor applications in the range –5 ... +50 °C

- Individual valve interface ASI-EVA for Namur valves

- Sensor box with visual position detection DAPZ

Valves

- A universal solution from the individual valve interface up to the compact solution with 8 valves

- Integrated inputs on individual valve interfaces and valve terminals CPV, CPA, MPA and VTSA/VTSA-F

- More inputs thanks to 4-fold and 8-fold input modules

- On request: Application-specific valves and integration solutions

Valve interface variants

Individual valve interface ASI-EVA

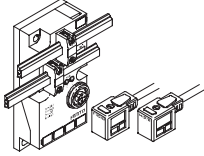

The perfect solution for 1 or 2 distributed valves and sensors

- Optimum pneumatic configuration within the range 10 ... 30,000 l/min

- Obtain the appropriate individual valve
- Then connect it to the AS-interface using Festo plug and work™

- This solution offers the maximum in mechanical, pneumatic and electrical flexibility

Compact valve terminal CPV

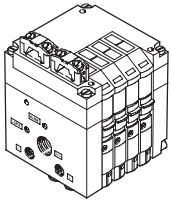

Maximum performance of 400 ... 1,600 l/min with minimal space requirement

- Valve combinations of 2, 4 or 8 valve slices
- Vacuum generation, relays and more in one unit

- Smart tubing system via pneumatic multiple connector plate:
 - Rapid replacement of valve terminals
 - With control cabinet installation: no internal tubing required

- M8 inputs included for each valve position
- Ex Zone 2, 22
- ASI Specification V2.0, V2.1 or V3.0

Modular valve terminal CPA

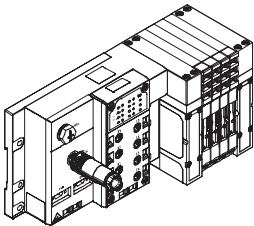

- Valves on a sub-base: individual valves can be easily replaced
- CPA: compact and modular from 300 ... 650 l/min
- Flexible valve combinations of 2 ... 8 solenoid coils

- Valve terminals can be expanded at a later date
- 4 or 8 inputs with selectable connection technology

- Selectable connection technology on the bus: flat cable or M12 round cable
- Addressing socket

Modular, multi-functional valve terminal MPA

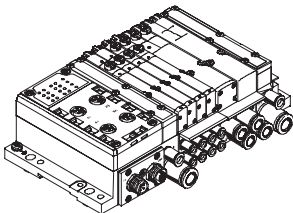

- Valves on a sub-base: individual valves can be easily replaced
- MPA: sturdy and modular from 360 ... 700 l/min
- Flexible valve combinations for 2 ... 8 solenoid coils
- Valve terminals can be expanded at a later date

- Mix of MPA1/2 on a valve terminal possible for optimised flow rates and control loop systems
- All valve functions, regulators and pressure gauges for variable pressure adjustment per valve position.
- 4 or 8 inputs with selectable connection technology

- Selectable connection technology on the bus. Flat cable in the case of the 4E4A version or M12 round cable in the case of the 4E4A and 8E8A versions (where 'E' stands for inputs and 'A' outputs)

Valve interface variants

Modular, multi-functional valve terminal VTSA/VTSA-F

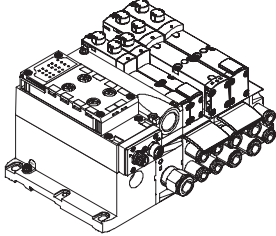

- Standard valves 18, 26 and 42 mm to ISO 17504-2 and 5599-2 on a sub-base: individual valves can be easily switched
- VTSA/VTSA-F: compact and modular from 550 ... 1,500 l/min
- Flexible valve combinations for 1 ... 8 solenoid coils
- Valve terminals can be expanded at a later date
- Mix of 3 valve sizes on a valve terminal possible for optimised flow rates and control loop systems
- All valve functions, multiple pressure zones, regulators and pressure gauges for precision pressure adjustment per valve position, flow control, pressure shut-off plates for valve replacement under pressure (hot-swap) and additional components for vertical stacking.
- 4 or 8 inputs with selectable connection technology
- Selectable connection technology on the bus. Flat cable in the case of the 4E4A version or M12 round cable in the case of the 4E4A and 8E8A versions (where 'E' stands for inputs and 'A' outputs)

Compact I/O modules, valve interfaces

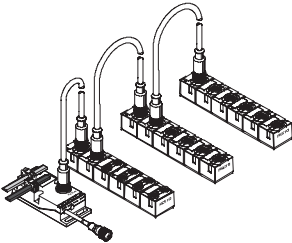

- Highly compact modules
- Sturdy, encapsulated electrics
- Bus and auxiliary power supply 2x M12 looped through
- Inputs 200 mA
- Outputs 1 A
- 8 inputs M8
- 4 inputs and 3 outputs M12
- 4 inputs and 2 outputs with solenoid coil plug

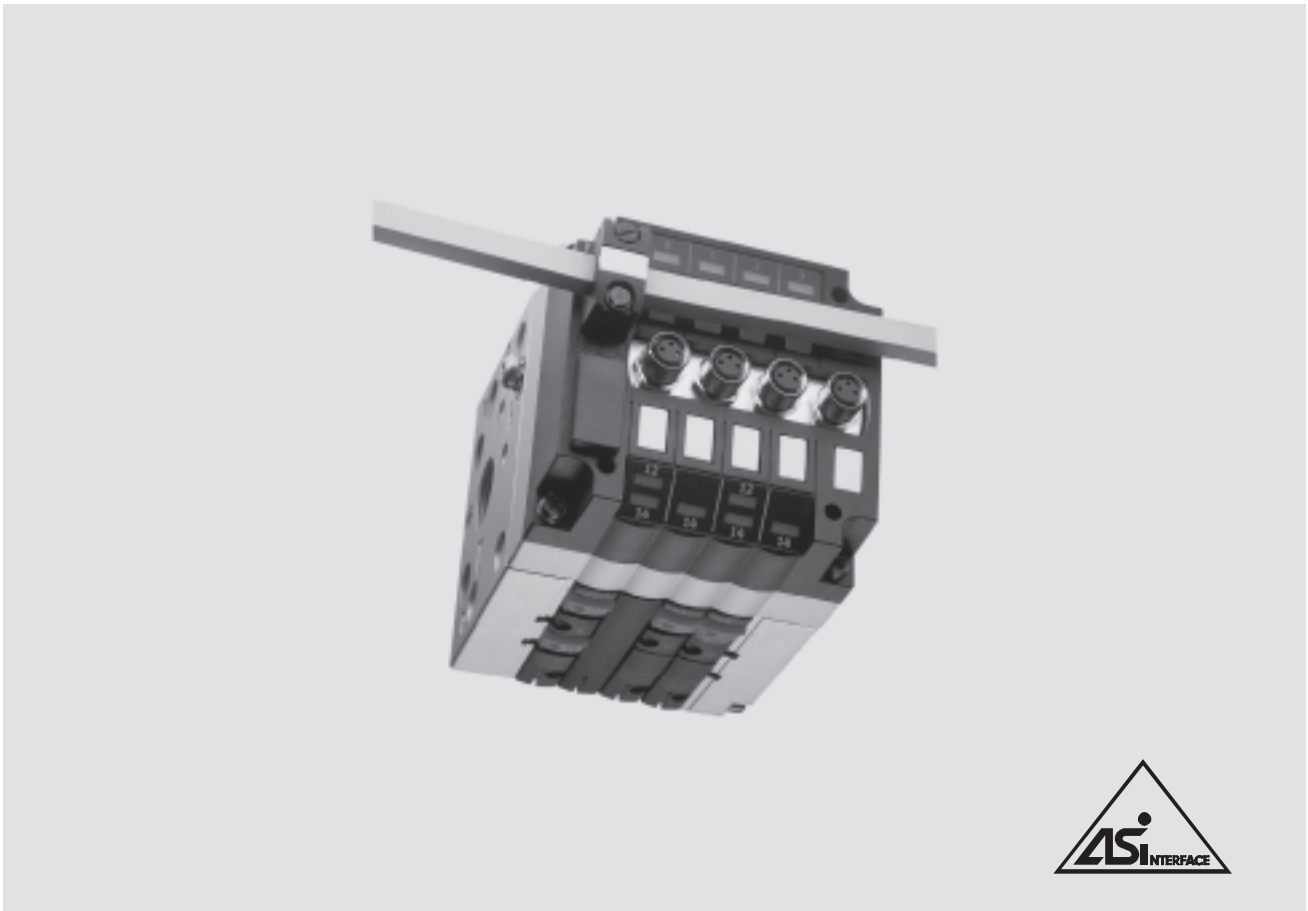

CPV valve terminals with AS-interface – Valve configuration options

CPV valve terminals with AS-interface can be configured with a wide range of valve slices. The system supports a maximum of 8 outputs and 8 inputs per AS-interface slave.

This gives the following basic valve slice configuration options (see tables on following page). Vacant positions can be configured instead of valve slices at any position.

General data

- With or without 24 V DC auxiliary power supply for solenoid coils (EMERGENCY-STOP circuitry) depending on bus interface
- Solutions with and without integrated inputs
- Width 10, 14 or 18 mm

Versions

- 2, 4 or 8 valve slices
- With 4 or 8 inputs, either
 - standard mode (SPEC V2.0)
 - A/B mode (SPEC V2.1)
 - A/B mode (SPEC V3.0, profile 7.A.7)
- Optionally with floating relay outputs
- Valves with integrated separation of channels 1 and 11
- Separator plates for the creation of pressure zones
- Suitable for vacuum
- Vacant positions for subsequent extension
- Optionally with pneumatic multiple connector plate

Application

- Cost-effective connection of 2, 4 or 8 valve slices to the AS-interface
- Comprehensive range of valve functions
- Decentralised machine and system structures, for example
 - in handling technology
 - in conveyor technology
 - in the packaging industry
 - in sorting systems
 - in upstream machine functions

 Note

Please follow the links below for more details on the various pneumatic functions.

➔ Internet: type 10

Types of valve terminal with AS-interface									
Code	Type	Valve slices	Solenoid coils	Inputs (M8 connection)	Auxiliary power supply		Size		
					With	Without	CPV10	CPV14	CPV18
AZ	CPV1x-GE-ASI-2-Z	2	4	–	■	–	■	■	■
AS/AZ	CPV1x-GE-ASI-4 (-Z) ¹⁾	4	4	–	■	■	■	■	–
AZ	CPV18-GE-ASI-4-Z	4	4	–	■	–	–	–	■
AE/AO	CPV1x-GE-ASI-4E4A (-Z)	4	4	4	■	■	■	■	–
AE	CPV1x-GE-ASI-8E8A-Z	8	8	8	■	–	■	■	–
BE	CPV1x-GE-ASI-4E3A (-Z)	4	3	4	■	–	■	■	–
BE	CPV1x-GE-ASI-8E6A-Z	8	6	8	■	–	■	■	–
CE	CPV1x-GE-ASI-4E4A-Z-M8-CE	4	4	4	■	–	■	■	–
CE	CPV1x-GE-ASI-8E8A-Z-M8-CE	8	8	8	■	–	■	■	–

1) The load voltage (auxiliary power supply via the black cable) can be connected/disconnected separately.

Permissible combinations in valve position allocation								
Type	Slave n				Slave n+1			
	0	1	2	3	4	5	6	7
CPV1x-GE-ASI-2-Z	M	M						
	J	M						
	M	J						
	J	J						
CPV18-GE-ASI-4-Z	M	M	M	M				
CPV1x-GE-ASI-4E4A (-Z) CPV10-GE-ASI-4A (-Z) CPV14-GE-ASI-4A (-Z)	M	M	M	M				
	J	Vacant position	M	M				
	M	M	J	Vacant position				
	J	Vacant position	J	Vacant position				
CPV1x-GE-ASI-4E3A -Z ¹⁾	M	M	M	Vacant position				
	J	Vacant position	M	Vacant position				
CPV1x-GE-ASI-8E8A-Z ¹⁾ CPV1x-GE-ASI-8E8A-Z-CE ¹⁾	M	M	M	M	M	M	M	M
	J	Vacant position	M	M	M	M	M	M
	M	M	J	Vacant position	M	M	M	M
	J	Vacant position	J	Vacant position	M	M	M	M

	M	M	M	M	M	M	M	M
	M	M	M	M	J	Vacant position	M	M
	M	M	M	M	M	M	J	Vacant position
CPV1x-GE-ASI-8E6A-Z ¹⁾	M	M	M	Vacant position	M	M	M	Vacant position
	M	M	M	Vacant position	J	Vacant position	M	Vacant position
	J	Vacant position	M	Vacant position	M	M	M	Vacant position
	J	Vacant position	M	Vacant position	J	Vacant position	M	Vacant position

- 1) - Valve slices with 2 outputs must be configured at positions 0, 2, 4, 6 (or positions 0, 4 with A/B mode).
- Valve slices with 2 outputs always have a vacant position.
- Slaves n and n+1 can be configured independently of one another. This gives a total of 16 different configuration options.
- M Valve slice with single solenoid valve or a different valve slice with an output.
- J Valve slice with double solenoid valve or a different valve slice with two outputs.

AS-interface® components

CPV valve terminals with integrated inputs, to SPEC V2.0

FESTO

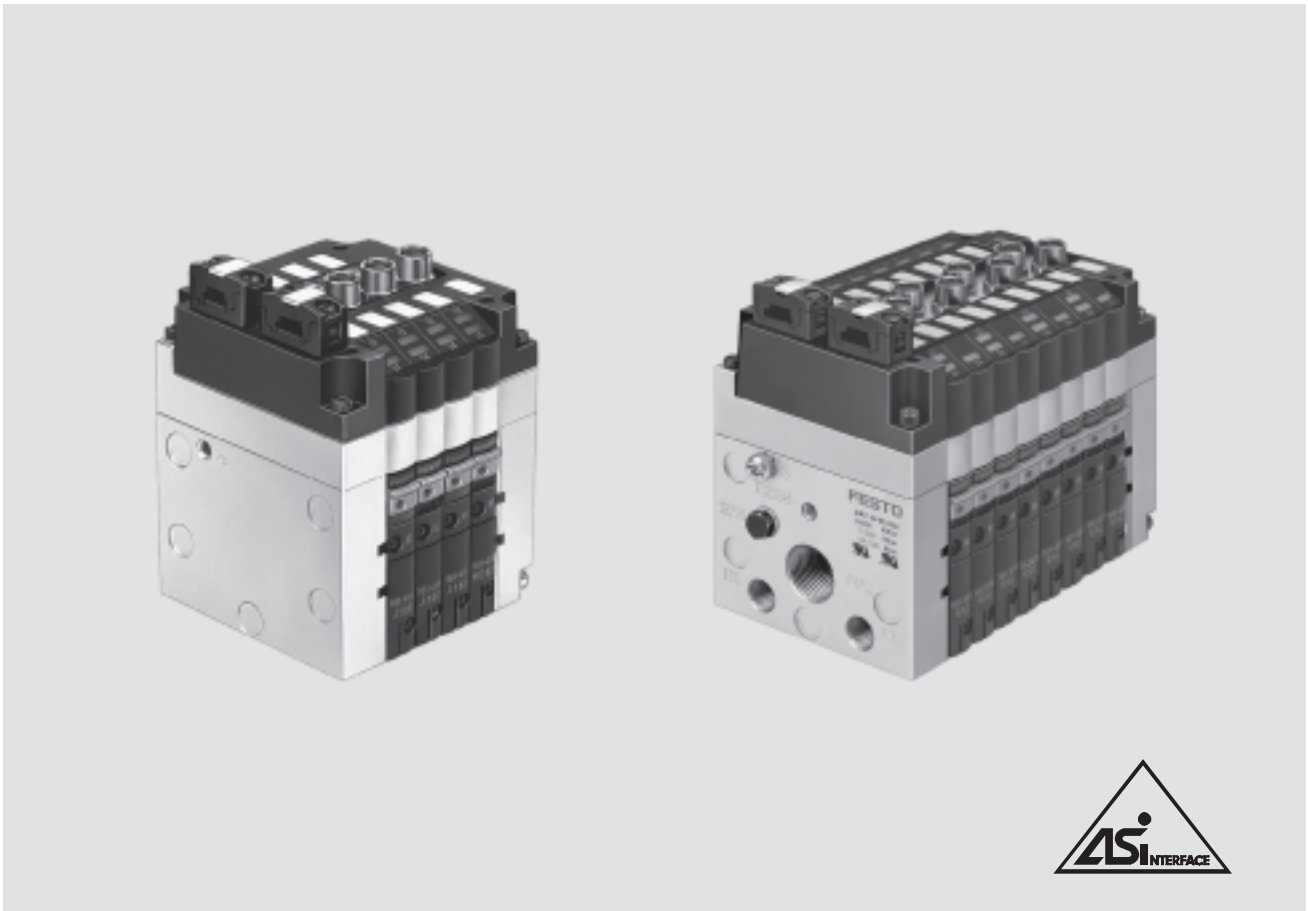

CPV valve terminals with integrated inputs, to Specification V2.0

General data

- Cubic design for exceptional performance and low weight
- Highly flexible thanks to various pneumatic functions (valve variants), different pressure ranges, vacuum switches and the option of integrated vacuum generation
- Floating relay outputs (optional)
- Connection for auxiliary power supply for EMERGENCY-STOP conditions
- Protection class IP65

LED displays for:

- Status display for inputs
- Switching status of valves
- PWR-LED (power)
- FAULT-LED (fault)

Versions

- Width 10 and 14 mm
- 4 or 8 inputs
- 4 or 8 valve positions
- Up to four pressure zones
- Suitable for vacuum
- Vacuum generation

- Various valve functions on one valve terminal, for example
 - 2x 3/2-way valve
 - 5/2-way valve, single solenoid
 - 5/2-way valve, double solenoid
 - 5/3-way valve
 - 2x 2/2-way valve
 - Valves with integrated separation of channels 1 and 11
 - Separator plate
 - Vacant position
- Additional function (screwed onto valve slice)
 - One-way flow control valve
- Various mounting options

Application

- Flexible and cost-effective connection of 4 or 8 valve slices and up to 8 sensors to the M8 inputs to Spec. V2.0, 31 slaves, bus cycle max. 5 ms. Executable on all masters from Spec. V2.0 or higher.

-  - Note

Please follow the links below for more details on the various pneumatic functions.

➔ Internet: type 10

AS-interface® components

CPV valve terminals with integrated inputs, to SPEC V2.0

FESTO

Technical data					
Type		CPV-...-GE-ASI-4E4A-Z-M8	CPV-...-GE-ASI-4E4A-M8	CPV-...-GE-ASI-8E8A-Z-M8	
Part No.	Order via order code/valve terminal configurator				
Code		AE	AO	AE	
Valves	Number of valve slices/coils	4	4	8	
	Valve width [mm]	10/14			
	Setting of the valve configuration	Integrated DIL switch			
	External power supply 24 V DC	Yes	No	Yes	
	Digital inputs	4	4	8	
	Connection technology	M8, 3-pin			
	Sensor supply via AS-interface	Short circuit and overload proof			
	Sensor connection	2-wire and 3-wire sensors			
	Type	IEC 1131-2, type 2			
	Input circuitry	PNP (positive switching)			
	AS-interface connection	Connection technology	AS-interface flat cable plug (included in scope of delivery)		
Voltage range [V DC]		26.5 ... 31.6, reverse polarity protected			
Residual ripple [mVss]		20			
Current consumption [mA] of inputs • In 0 status • In 1 status (no current consumption by sensors) • In 1 status (max. current consumption by sensors) • Max. per input • Max. per valve – when switching on – following a current reduction				CPV10/14	
			7	61/95	40
			35	89/123	96
			240	191/225	278
	200	200	200		
		25/38.75 8.75/12.5			
Load voltage connection	Connection technology	AS-interface flat cable plug (version turned through 180° must be ordered separately)			
	Nominal voltage [V DC]	24 ±10%			
	Residual ripple [Vss]	4			
	Current consumption of valves • when switching on [mA] • following a current reduction [mA]		CPV10/14	No load voltage connection	CPV10/14
			108/176 42/72		200/310 70/100
LED displays	ASI-LED	Power/green			
	AUX-PWR-LED	Auxiliary power supply/green	None	Auxiliary power supply/green	
	FAULT-LED	Fault LED/red			
	Inputs	Green			
	Valves	Yellow			
General data	Protection class (to EN 60529)	IP65 (fully assembled)			
	Electromagnetic compatibility • Interference emission • Interference immunity	Tested to EN 55011, limit value class B			
		Tested to DIN EN 61000-4-2, DIN EN 61000-4-4 and EN V 50140			
	CE mark	Yes, in accordance with EU Directive 89/336/EEC			
	Temperature range [°C]	Operation: -5 ... +50; storage/transport: -20 ... +70			
	Materials	Housing: aluminium; cover: polyamide; seals: nitrile rubber; polychloroprene rubber			
	Dimensions	➔ 21			
	Weight	➔ 21			
	Pneumatic data	➔ Internet: type 10			
AS-interface data	ID code	F _H (ID = F _H ; ID1 = F _H ; ID2 = F _H)			
	IO code	7 _H			
	Profile	S-7.F			

AS-interface® components

FESTO

CPV valve terminals with integrated inputs, for A/B mode to SPEC V2.1

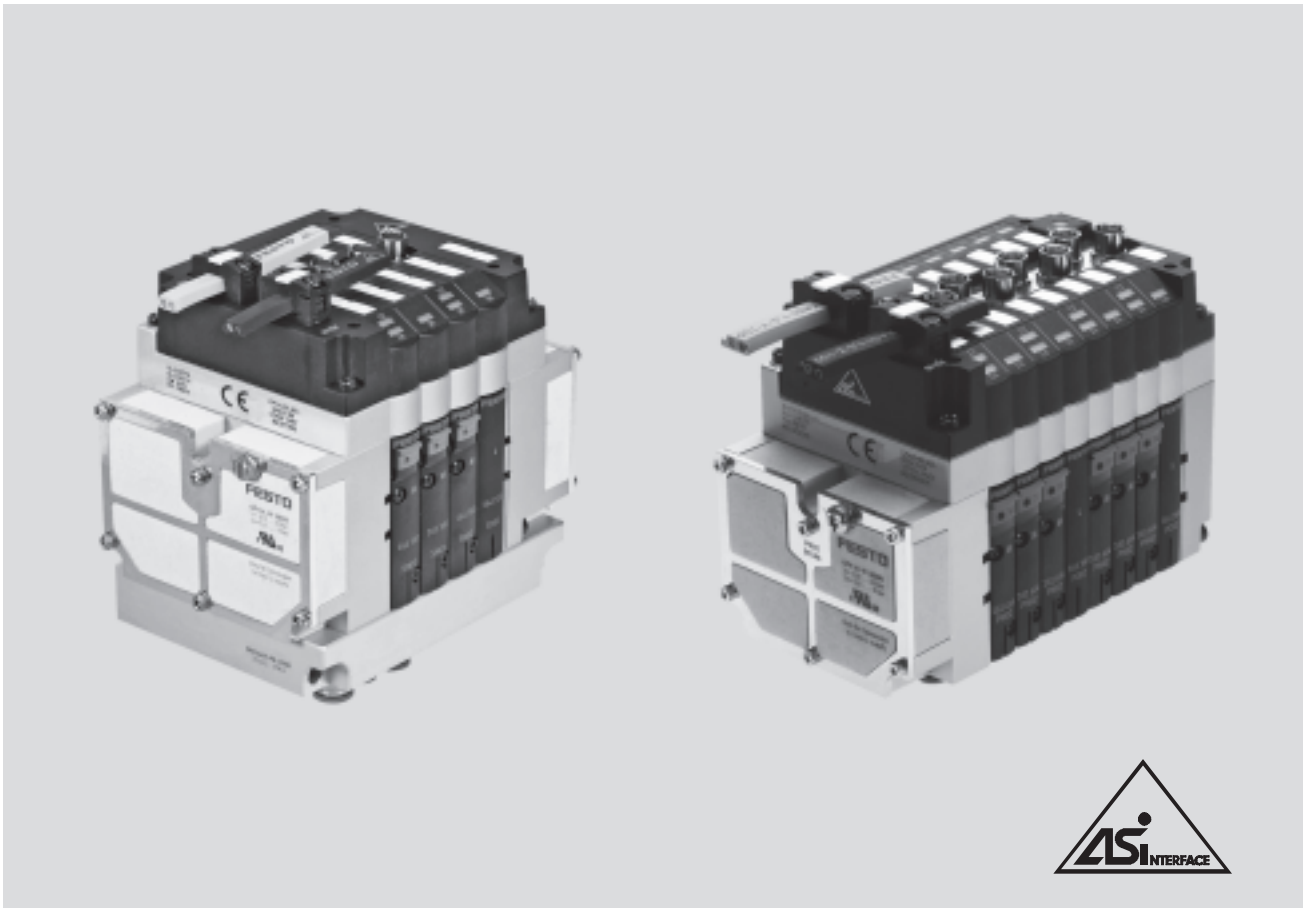

CPV valve terminals with integrated inputs, for A/B mode to Specification V2.1¹⁾

General data

- A/B mode increases the performance of each master
 - 100% more inputs (248 instead of 124)
 - 50% more outputs (186 instead of 124)
- Cubic design for exceptional performance and low weight
- Highly flexible thanks to various pneumatic functions (valve variants), different pressure ranges, vacuum switches and the option of integrated vacuum generation
- Floating relay outputs, optional

- Connection for auxiliary power supply for EMERGENCY-STOP conditions
- Protection class IP65

LED displays for:

- Status display for inputs
- Switching status displays for valves
- PWR-LED (power)
- FAULT-LED (fault)²⁾

Versions

- Width 10 and 14 mm
- 4 or 8 inputs
- 3 or 6 valve positions

- Up to four pressure zones
- Suitable for vacuum
- Vacuum generation
- Various valve functions on one valve terminal, for example
 - 2x 3/2-way valve
 - 5/2-way valve, single solenoid
 - 5/2-way valve, double solenoid
 - 5/3-way valve
 - 2x 2/2-way valve
 - Valves with integrated separation of channels 1 and 11
 - Separator plate
 - Vacant position

- Additional function (screwed onto valve slice)
 - One-way flow control valve
- Various mounting options

Application

- AS-i networks with A/B mode to SPEC V2.1 and SPEC V3.0, 62 slaves, bus cycle 10 ms
- Flexible and cost-effective connection of 3 or 6 valve slices and up to 8 sensors to the M8 inputs



Note

Please follow the links below for more details on the various pneumatic functions.

➔ Internet: type 10

1) Slave compatible with SPEC V3.0
2) Peripherals faults to SPEC V2.1 not yet implemented

AS-interface® components

CPV valve terminals with integrated inputs, for A/B mode to SPEC V2.1

Technical data		CPV-...-GE-ASI-4E3A-Z-M8	CPV-...-GE-ASI-8E6A-Z-M8	
Part No.	Order via order code/valve terminal configurator			
Code	BE		BE	
Valves	Number of valve slices/coils	3	6	
	Valve width [mm]	10/14		
	Setting of the valve configuration	Integrated DIL switch		
	External power supply 24 V DC	Yes		
	Digital inputs	4	8	
	Connection technology	M8, 3-pin		
	Sensor supply via AS-interface	Short circuit and overload proof		
	Sensor connection	2-wire and 3-wire sensors		
	Type	IEC 1131-2, type 2		
	Input circuitry	PNP (positive switching)		
	AS-interface connection	Connection technology	AS-interface flat cable plug (included in scope of delivery)	
Voltage range [V DC]		26.5 ... 31.6, reverse polarity protected		
Residual ripple [mVss]		20		
Current consumption of inputs • In 0 status • In 1 status (no current consumption by sensors) • In 1 status (max. current consumption by sensors) • Max. per input				
			7	40
			35	96
		137	278	
	200	200		
Load voltage connection	Connection technology	AS-interface flat cable plug (version turned through 180° must be ordered separately)		
	Nominal voltage [V DC]	24 ±10%		
	Residual ripple [Vss]	4		
	Current consumption of valves • when switching on [mA] • following a current reduction [mA]		CPV10/14	CPV10/14
			81/132	150/233
	32/54	53/75		
LED displays	ASI-LED	Power/green		
	AUX-PWR-LED	Auxiliary power supply/green		
	FAULT-LED	Fault LED/red		
	Inputs	Green		
	Valves	Yellow		
General data	Protection class (to EN 60529)	IP65 (fully assembled)		
	Electromagnetic compatibility • Interference emission • Interference immunity	Tested to EN 55011, limit value class B		
		Tested to DIN EN 61000-4-2, DIN EN 61000-4-4 and EN V 50140		
	CE mark	Yes, in accordance with EU Directive 89/336/EEC		
	Temperature range [°C]	Operation: -5 ... +50; storage/transport: -20 ... +70		
	Materials	Housing: aluminium; cover: polyamide; seals: nitrile rubber, polychloroprene rubber		
	Dimensions	➔ 21		
	Weight	➔ 21		
	Pneumatic data	➔ Internet: type 10		
	AS-interface data	ID code	ID = A _H ; ID1 = 7 _H ; ID2 = E _H	
IO code		7 _H		
Profile		S-7.A.E		

AS-interface® components

CPV valve terminals with integrated inputs, for A/B mode to SPEC V3.0

FESTO

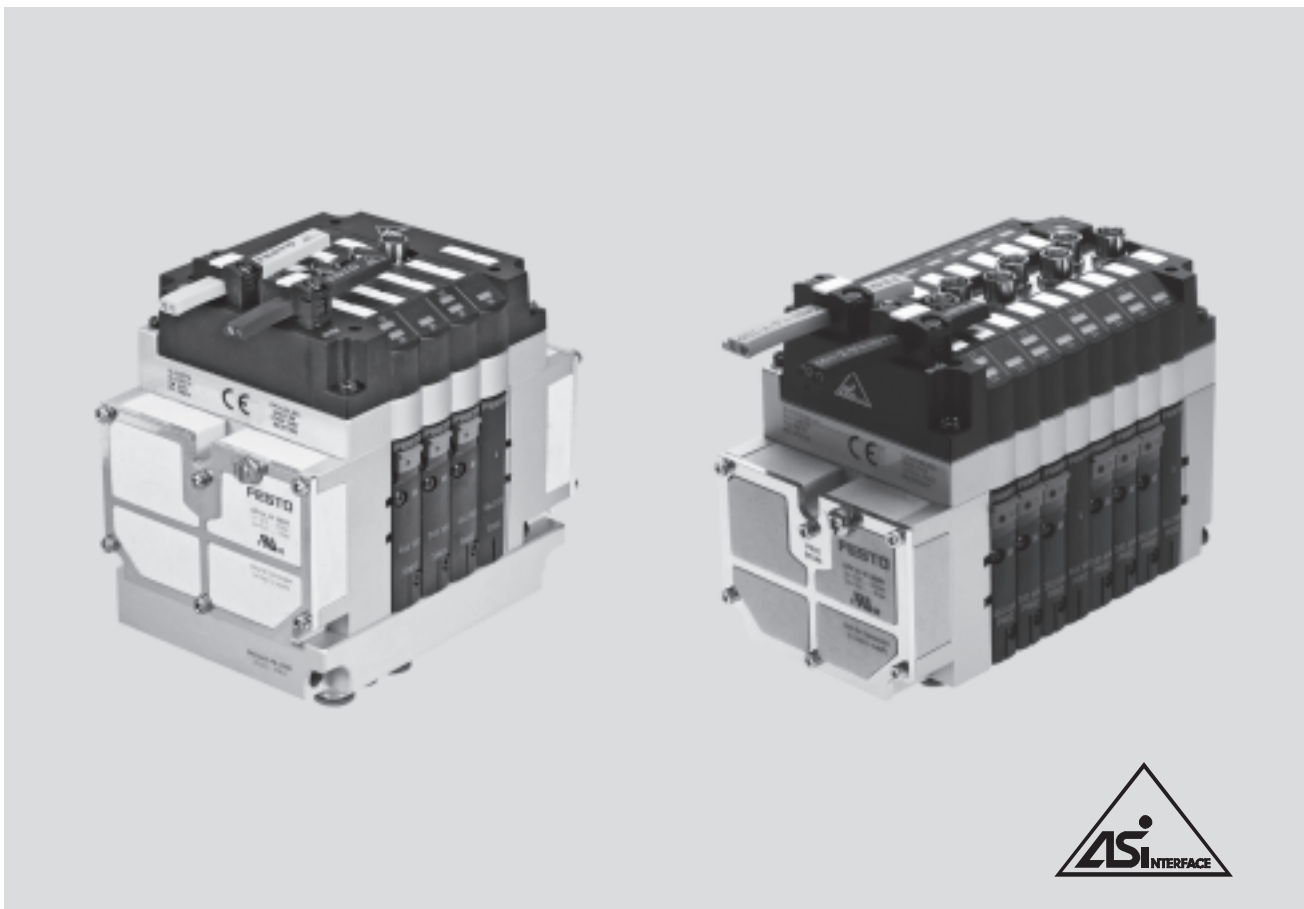

CPV valve terminals with integrated inputs, for A/B mode to specification V3.0, profile 7.A.7

General data

- A/B mode increases the performance of each master
 - 100% more inputs (248 instead of 124)
 - 100% more outputs (248 instead of 124)
- Cubic design for exceptional performance and low weight
- Highly flexible thanks to various pneumatic functions (valve variants), different pressure ranges, vacuum switches and the option of integrated vacuum generation
- Floating relay outputs, optional

- Connection for auxiliary power supply for EMERGENCY-STOP conditions
- Protection class IP65

LED displays for:

- Status display for inputs
- Switching status displays for valves
- PWR-LED (power)
- FAULT-LED (fault)

Versions

- Width 10 and 14 mm
- 4 or 8 inputs
- 4 or 8 valve positions

- Up to four pressure zones
- Suitable for vacuum
- Vacuum generation
- Various valve functions on one valve terminal, for example
 - 2x 3/2-way valve
 - 5/2-way valve, single solenoid
 - 5/2-way valve, double solenoid
 - 5/3-way valve
 - 2x 2/2-way valve
 - Valves with integrated separation of channels 1 and 11
 - Separator plate
 - Vacant position

- Additional function (screwed onto valve slice)
 - One-way flow control valve
- Various mounting options

Application

- AS-i networks with A/B mode to SPEC V3.0, profile 7.A.7, 62 slaves, bus cycle 20 ms
- Flexible and cost-effective connection of 4 or 8 valve slices and up to 8 sensors to the M8 inputs



Note
Slaves to Specification V3.0 require an ASi master to Specification V3.0; these detect the new slave profiles automatically.

Please follow the links below for more details on the various pneumatic functions.
→ Internet: type 10

AS-interface® components

CPV valve terminals with integrated inputs, for A/B mode to SPEC V3.0

Technical data		CPV-...-GE-ASI-4E4A-Z M8-CE	CPV-...-GE-ASI-8E8A-Z M8-CE	
Type		Order via order code/valve terminal configurator		
Part No.		CE		
Code		CE		
Valves	Number of valve slices/coils	4	8	
	Valve width [mm]	10/14		
	Setting of the valve configuration	Integrated DIL switch		
	External power supply [V DC]	24		
	Digital inputs	4	8	
	Connection technology	M8, 3-pin		
	Device-specific diagnostics	Short circuit/overload of inputs		
	Sensor connection	2-wire and 3-wire sensors		
	Input characteristic	IEC 1131-2, type 2		
	Switching logic at inputs	PNP (positive switching)		
	AS-interface connection	Connection technology	AS-interface flat cable plug (included in scope of delivery)	
		Number of slaves per device	1	2
Voltage range [V DC]		26.5 ... 31.6, reverse polarity protected		
Residual ripple [mVss]		20		
Debounce time at inputs (at 24 V) [ms]		Typically 3		
Set using AS-interface addressing device		1A ... 31A (0) 1B ... 31B		
Switching level [V]				
Signal 0		≤ 5		
Signal 1		≥ 11		
Current consumption of inputs		[mA]		
	• In 0 status	20	40	
	• In 1 status (no current consumption by sensors)	Max. 48	Max. 96	
• Max. per input	200	200		
Load voltage connection	Connection technology	AS-interface flat cable plug (version turned through 180° must be ordered separately)		
	Nominal voltage [V DC]	24 ±10%		
	Residual ripple [Vss]	4		
	Current consumption of valves (type-dependent)	CPV10/14	CPV10/14	
	• when switching on [mA]	Max. 115/175	Max. 240/460	
• following a current reduction [mA]	Max. 55/75	Max. 95/120		
LED displays	ASI-LED	Power/green		
	AUX-PWR-LED	Auxiliary power supply/green		
	FAULT-LED	Fault LED/red		
	Inputs	Green		
	Valves	Yellow		
General data	Protection class (to EN 60529)	IP65 (fully assembled)		
	Relative air humidity [%]	0 ... 95 (non-condensing)		
	CE mark	To EU EMC Directive		
	Temperature range [°C]	Operation: -5 ... +50; storage/transport: -20 ... +70		
	Materials	Housing: aluminium die-cast; cover: polyamide; seals: nitrile rubber, polychloroprene rubber		
	Dimensions	➔ 21		
	Weight	➔ 21		
	Pneumatic data	➔ Internet: type 10		
AS-interface data	ID code	ID = A _H ; ID1 = 7 _H ; ID2 = 7 _H		
	IO code	7 _H		
	Profile	S-7.A.7		

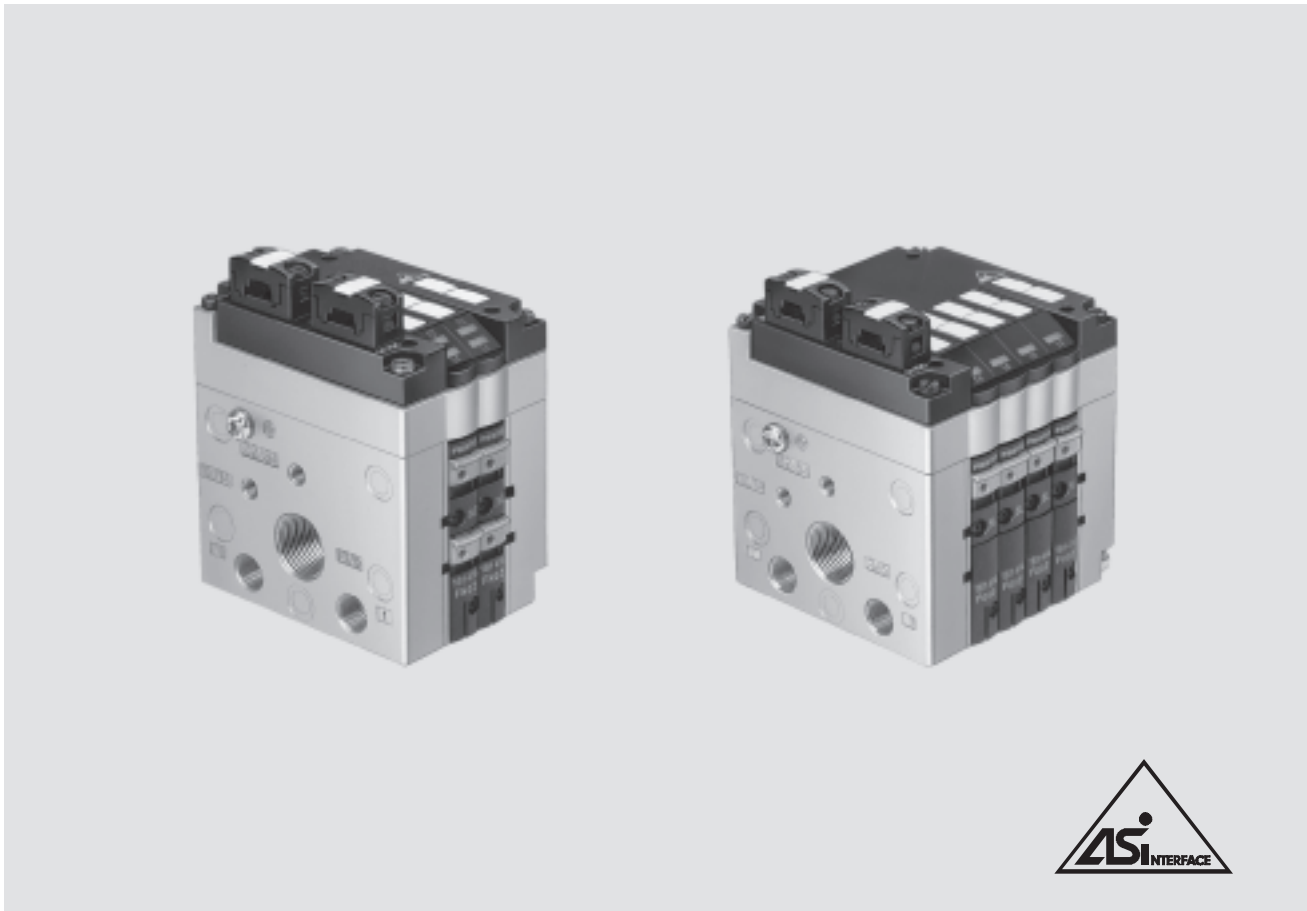

CPV valve terminals without inputs, to Specification V2.1¹⁾

General data

- Cubic design for exceptional performance and low weight
- Highly flexible thanks to various pneumatic functions (valve variants), different pressure ranges, vacuum switches and the option of integrated vacuum generation
- Floating relay outputs, optional
- Connection for auxiliary power supply for EMERGENCY-STOP conditions
- Protection class IP65

LED displays for:

- Switching status displays for valves
- PWR-LED (power)
- FAULT-LED (fault)²⁾
- Valve diagnostics: short circuit or wire break at valve solenoid coil, valve does not respond (no movement of the plunger)

Versions

- Width 10, 14 and 18 mm
- 2 or 4 valve positions
- Up to two pressure zones
- Suitable for vacuum
- Vacuum generation

- Valve terminal with 4 valve positions:
 - With or without 24 V DC auxiliary power supply for solenoid coils (EMERGENCY-STOP circuitry)
 - The auxiliary power supply is always integrated and can be subsequently switched off using the DIL switch
- Various valve functions on one valve terminal, for example
 - 2x 3/2-way valve
 - 5/2-way valve, single solenoid
 - 5/2-way valve, double solenoid
 - 5/3-way valve

- 2x 2/2-way valve
- Valves with integrated separation of channels 1 and 11
- Separator plate
- Vacant position
- Additional function (screwed onto valve slice)
 - One-way flow control valve
- Extensive mounting options

Application

- Flexible and cost-effective connection of 2 or 4 valve slices, 31 slaves, bus cycle max. 5 ms

 Note

Please follow the links below for more details on the various pneumatic functions.

➔ Internet: type 10

1) Slave compatible with SPEC V3.0

2) Valve terminal with 4 valve positions: peripherals faults to SPEC V2.1 implemented
Valve terminal with 2 valve positions: peripherals faults not implemented

AS-interface® components

CPV valve terminals without inputs, to SPEC V2.1

FESTO

Technical data		CPV-...-GE-ASI-2-Z	CPV-...-GE-ASI-4-Z ¹⁾	CPV-...-GE-ASI-4 ¹⁾
Part No.	Order via order code/valve terminal configurator			
Code	AZ		AS/AZ	AS
Valves	Number of valve slices/coils	2/4	4/4	4/4
	Valve width	10 mm	■	■
		14 mm	■	■
		18 mm	■	-
	Setting of the valve configuration	None (permanently assigned)		
	External power supply 24 V DC	Yes	Yes ²⁾	No ²⁾
		Set using DIL switch		
AS-interface connection	Connection technology	AS-interface flat cable plug (must be ordered separately)		
	Voltage range [V DC]	26.5 ... 31.6, reverse polarity protected		
	Residual ripple [mVss]	20		
	Current consumption of all valves	CPV10/14/18	CPV10/14/18	CPV10/14/18
	• without current reduction [mA]	25/25/25	25/25/25	150/200/235
• with current reduction [mA]	25/25/25	25/25/25	60/70/150	
Load voltage connection	Connection technology	AS-interface flat cable plug (must be ordered separately)		
			Blanking plug for sealing the unused connection enclosed	
	Nominal voltage [V DC]	24 ±10%		
	Residual ripple [Vss]	4		
	Max. starting current	CPV10/14/18	CPV10/14/18	No load voltage connection
	• before current reduction [mA]	108/176/320	110/165/246	
• following a current reduction [mA]	48/72/120	35/40/100		
LED displays	PWR-LED	Power/green		
	FAULT-LED	Fault LED/red	Peripherals fault LED/red Valve diagnostics: short circuit or wire break at valve solenoid coil, valve does not respond (no movement of the plunger)	
	Valves	Yellow		
General data	Protection class (to EN 60 529)	IP65 (fully assembled)		
	Electromagnetic compatibility	<ul style="list-style-type: none"> Interference emission Interference immunity 		
	CE mark	Yes, in accordance with EU Directive 89/336/EEC		
	Temperature range [°C]	Operation: -5 ... +50; storage/transport: -20 ... +70		
	Materials	Housing: aluminium die-cast; cover: polyamide; seals: nitrile rubber, polychloroprene rubber		
	Dimensions	➔ 21		
	Weight	➔ 21		
	Pneumatic data	➔ Internet: type 10		
AS-interface data	ID code	F _H		
	IO code	8 _H		
	ID2 code	F _H	E _H (F _H with CPV18)	-
	Profile	S-8.F	S-8.F.E	
	Parameter P3		1 = enable 2 = disable	
	CPV valve diagnostic function			
Default	1 for CPV with valve diagnostics			

- 1) New as of hardware status 0105: single or double solenoid valves can be configured by means of a DIL switch.
- 2) With or without 24 V DC auxiliary power supply for solenoid coils (EMERGENCY-STOP circuitry). The auxiliary power supply is always integrated and can be switched on/off using the DIL switch.
- 3) None (permanently assigned)

AS-interface® components

CPV valve terminals – Connections/displays

Overview of connections/displays – CPV with AS-interface

CPV-...-GE-ASI-2-Z / ASI-4-(Z)

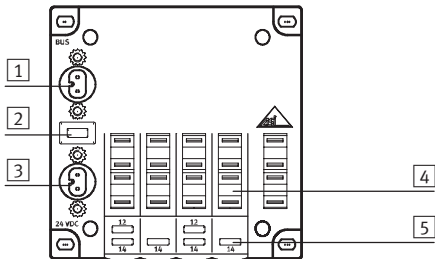

- 1 AS-interface bus connection
- 2 PWR LED (power, green)
Fault LED (fault, red)
- 3 Auxiliary power supply for valves (optional)
- 4 Inscription areas
- 5 LED display for valves

CPV-...-GE-ASI-4E4A(Z) / 4E/3A-...- / 4E/4A-...-CE

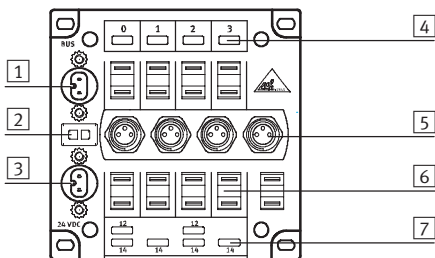

- 1 AS-interface bus connection
- 2 PWR LED (power, green)
Fault LED (fault, red)
- 3 Auxiliary power supply for valves (optional)
- 4 LED display for inputs (green)
- 5 Sensor connections
- 6 Inscription areas
- 7 LED display for valves (yellow)

CPV-...-GE-ASI-8E8A-Z / 8E/6A / 8E/8A-...-CE

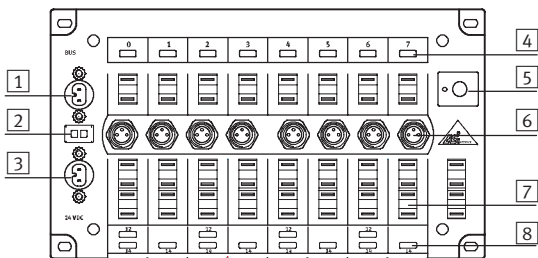

- 1 AS-interface bus connection
- 2 PWR LED (power, green)
Fault LED (fault, red)
- 3 Auxiliary power supply for valves
- 4 LED display for inputs (green)
- 5 Address selector button with LED
- 6 Sensor connections
- 7 Inscription areas
- 8 LED display for valves (yellow)

Pin allocation		
Inputs CPV	Pin	Allocation
	1	+24 V
	3	0 V
	4	Input

AS-interface® components

CPV valve terminals – Weights/dimensions

Weights [g] – Valve terminal type 10 with AS-interface			
Type	CPV10	CPV14	CPV18
Electrical connection plate with AS-interface connection			
• with 2 valve positions	85	130	275
• with 4(3) valve positions	110	175	355
• with 8(6) valve positions	200	300	
End plate, 2 pieces	160	280	740
Pneumatic multiple connector plate			
• on CP valve terminal with 2 valve positions	120	270	520
• on CP valve terminal with 4 valve positions	165	390	750
• on CP valve terminal with 6 valve positions	225	510	870
• on CP valve terminal with 8 valve positions	270	630	1300
Flat plate silencer	147	234	–
Relay plate	35	55	–
Blanking plate	25	45	90
Separator plate	25	45	90
Valve plate/vacuum generator	65	110	260
Functional module: One-way flow control valves	25	54	125

Dimensions – CPV with AS-interface

Download CAD data → www.festo.com

Without integrated inputs

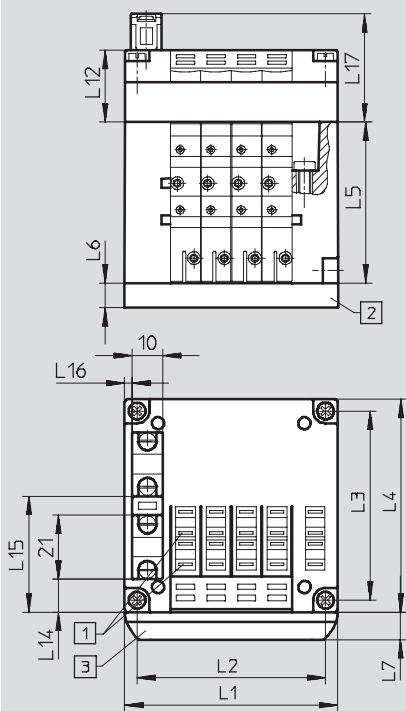

- 1 Slots for inscription labels
- 2 Pneumatic multiple connector plate
- 3 Inscription label holder

		L1	L2	L3	L4	L5	L6	L7	L12	L14	L15	L16	L17
CPV10	2-fold	50	41.8	62	71	52.8	15	9.5	–	10.9	38.1	2.5	35.5
	4-fold	70	61.8	62	71	52.8	15	9.5	23.5	10.9	38.1	2.5	35.5
CPV14	2-fold	68	58	78	89	58.8	20	9.5	–	14	52	5	35.5
	4-fold	96	86	78	89	58.8	20	9.5	23.5	14	52	5	35.5
CPV18	2-fold	96	85.5	106.5	118	73	20	9.5	–	27.4	68.2	10.4	40
	4-fold	132	121.5	106.5	118	73	20	9.5	28	27.4	68.2	10.4	40

Dimensions – CPV with AS-interface

Download CAD data → www.festo.com

CPV10/14 with integrated inputs

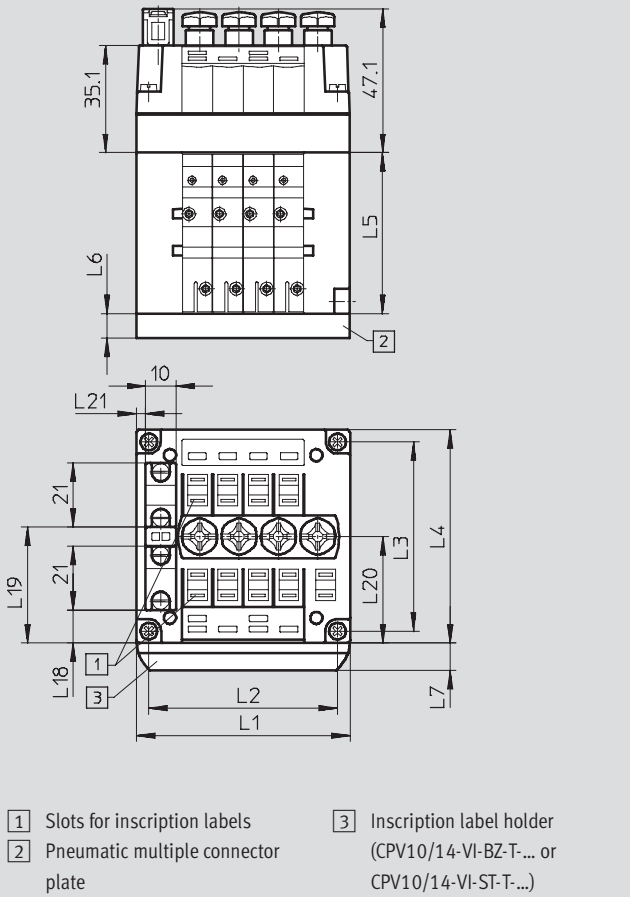

CPV10 with integrated inputs

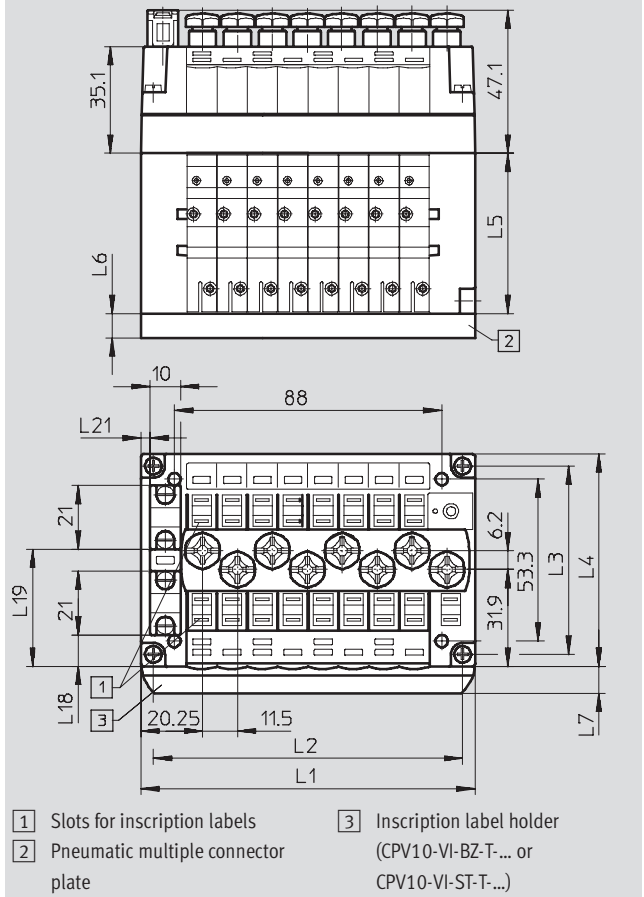

- 1 Slots for inscription labels
- 2 Pneumatic multiple connector plate
- 3 Inscription label holder (CPV10/14-VI-BZ-T... or CPV10/14-VI-ST-T...)

- 1 Slots for inscription labels
- 2 Pneumatic multiple connector plate
- 3 Inscription label holder (CPV10-VI-BZ-T... or CPV10-VI-ST-T...)

		L1	L2	L3	L4	L5	L6	L7	L18	L19	L20	L21
CPV10	4-fold	70	61.8	62	71	52.8	15	9.5	10.9	38.1	35	3
	8-fold	110	101.8						10.4	38.6	31.9	
CPV14	4-fold	96	86	78	89	58.8	20	9.5	18.8	46.8	43.3	5

Dimensions – CPV with AS-interface

Download CAD data → www.festo.com

CPV14 with integrated inputs

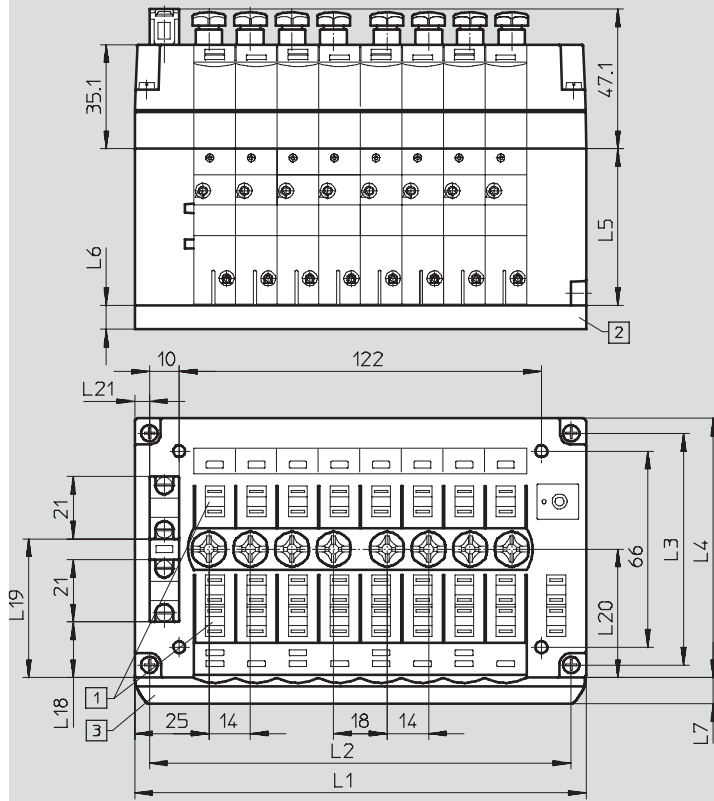







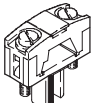
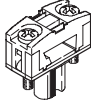

- 1 Slots for inscription labels
- 2 Pneumatic multiple connector plate
- 3 Inscription label holder
(CPV14-VI-BZ-T... or
CPV14-VI-ST-T...)

		L1	L2	L3	L4	L5	L6	L7	L18	L19	L20	L21
CPV14	8-fold	152	142	78	89	58.8	20	9.5	18.8	46.8	46.3	5

AS-interface® components

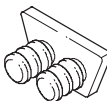
CPV valve terminals – Accessories

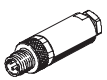

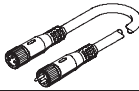
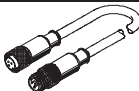
FESTO

Ordering data				
	Description		Type	Part No.
Bus connection				
	AS-interface flat cable, yellow	100 m	KASI-1,5-Y-100	18 940
	AS-interface flat cable, black	100 m	KASI-1,5-Z-100	18 941
	Flat cable socket		ASI-SD-FK	18 785
	Flat cable socket	Turned through 180°	ASI-SD-FK180	196 089
	Flat cable blanking plug		ASI-SD-FK-BL	196 090
	AS-interface flat cable distributor	Parallel cable	ASI-KVT-FK	18 786
	AS-interface flat cable distributor	Symmetrical cable	ASI-KVT-FK-S	18 797
	Cable cap for flat cable (scope of delivery 50 pieces)		ASI-KK-FK	18 787
	Cable sleeve (scope of delivery 20 pieces)		ASI-KT-FK	165 593
Sensor plugs				
	Straight sensor plug	M8, screw-in, 3-pin	SEA-3GS-M8-S	192 009
	Straight sensor plug	M8, solderable, 3-pin	SEA-GS-M8	18 696
	Protective cap	M8	ISK-M8	177 672
Connecting cable				
	Modular system for connecting cables → Internet: nebu		NEBU-...	–
	Connecting cable, straight plug, straight socket	M8, 0.5 m	KM8-M8-GSGD-0,5	175 488
		M8, 1.0 m	KM8-M8-GSGD-1	175 489
		M8, 2.5 m	KM8-M8-GSGD-2,5	165 610
		M8, 5.0 m	KM8-M8-GSGD-5	165 611

AS-interface® components

CPV valve terminals – Accessories

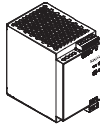
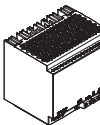
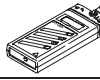
FESTO

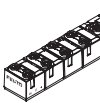
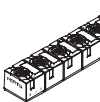
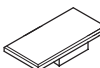
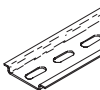
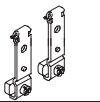
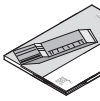
Ordering data				
	Description	Type	Part No.	
Miscellaneous				
	Primary switched mode modular power supply AS-interface power supply 4.8 A	SVG-1/230VAC-ASI-5A	547 869	
	Primary switched mode modular power supply 24 VDC power supply 5 A	SVG-1/230-24VDC-5A	547 867	
	Primary switched mode modular power supply 24 VDC power supply 10 A	SVG-1/230-24VDC-10A	547 868	
	Addressing device (power supply plug included in scope of delivery)	ASI-PRG-ADR	18 959	
	Addressing cable	KASI-ADR	18 960	
	AS-interface input module for 8 inputs M8	ASI-8DI-M8-3POL	542 124	
	AS-interface input/output module for 4 inputs/3 outputs M12	ASI-4DI3DO-M12X2-5POL-Z	542 125	
	Inscription labels 6x10mm in frames (64 pieces)	IBS 6x10	18 576	
	Inscription labels 9x20mm in frames (20 pieces)	IBS 9x20	18 182	
	H-rail to EN 60715	NRH-35-2000	35 430	
	Mounting for H-rail	CPV10/14-VI-BG-NRH-35	162 556	
		CPV18-VI-BG-NRH-35	163 291	
User's manual				
	CPV Pneumatics Description	German	P.BE-CPV-DE	165 100
		English	P.BE-CPV-EN	165 200
		French	P.BE-CPV-FR	165 130
		Italian	P.BE-CPV-IT	165 160
		Spanish	P.BE-CPV-ES	165 230
		Swedish	P.BE-CPV-SV	165 260

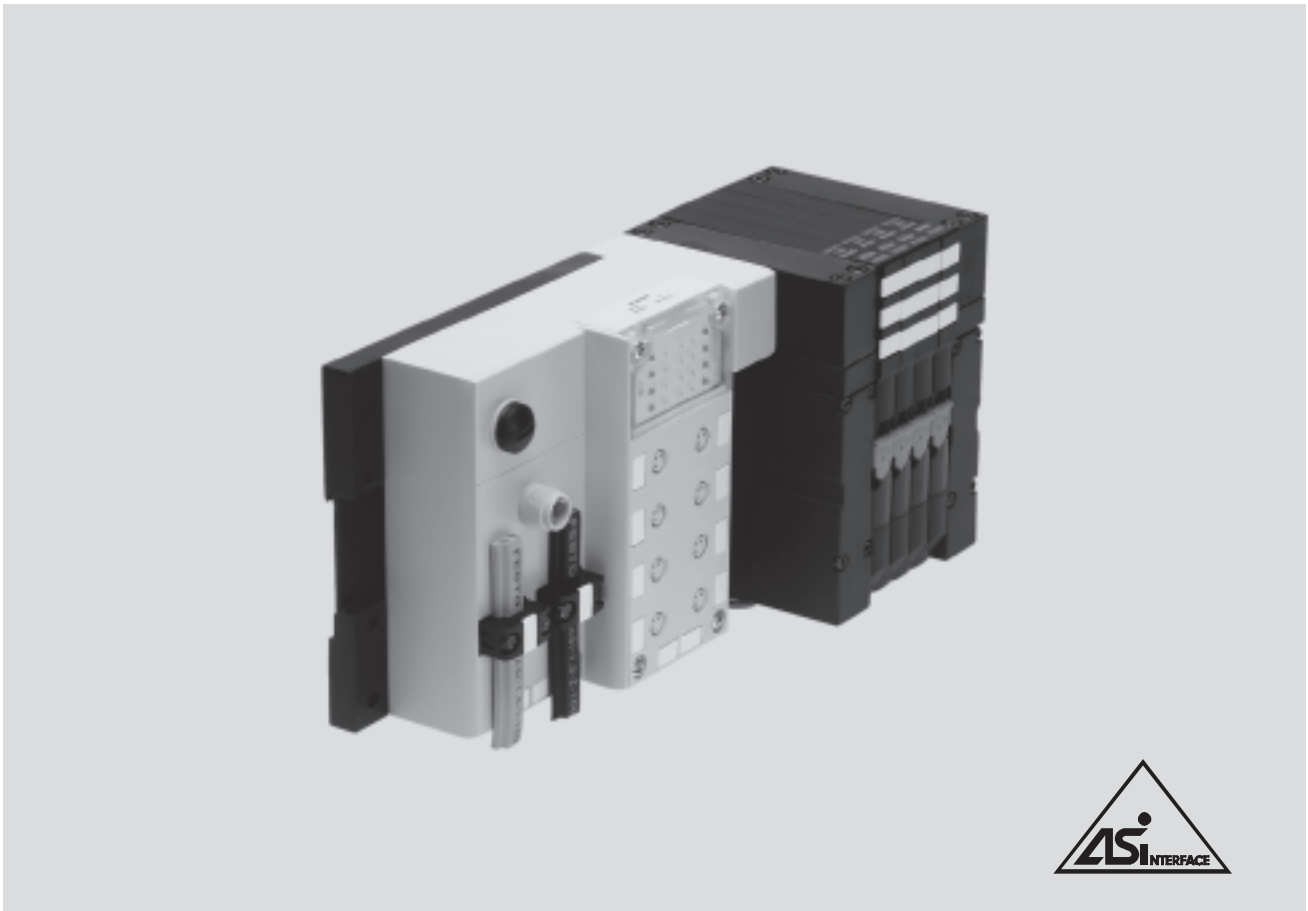

CPA valve terminals with AS-interface – Valve configuration options

CPA valve terminals with AS-interface can be flexibly configured with a wide range of valve slices. The system supports a maximum of 8 outputs and 8 inputs per valve terminal.

This gives the following basic valve configuration options (see tables on following page).

General data

- Solutions with and without integrated inputs
- Width 10 or 14 mm

- With or without 24 V DC auxiliary power supply for solenoid coils (EMERGENCY-STOP circuitry) in the case of the 4I/4O version. The auxiliary power supply is always integrated in the version with 8 inputs and cannot be subsequently switched off using the DIL switch
 - Selectable bus connection technology
 - Flat cable for AS-interface and auxiliary power supply
 - M12 round plug, 4-pin¹⁾
 - Selectable addressing
 - Via bus connection (M12 or flat cable)
 - Via addressing socket
- Versions**
- 2 to 8 valve slices, freely configurable
 - With 4 or 8 inputs
 - M12, M8, quick connection, tension spring or Sub-D connection technology
 - Separator plates for the creation of pressure zones
 - Suitable for vacuum
 - Subsequent extensions either
 - via unused valve positions
 - by converting the valve terminal

Application

- Flexible and cost-effective connection of 2 or 8 valve slices with input feedback
- Decentralised machine and system structures, for example
 - in handling technology
 - in conveyor technology
 - in the packaging industry
 - in sorting systems
 - suitable for energy chains thanks to connection via round cables

 Note

Please follow the links below for more details on the various pneumatic functions.

➔ Internet: type 12

¹⁾ Suitable cable distributor from flat cable to M12: ASI-KVT-FKx2-M12

Types of valve terminal with AS-interface							
Type ¹⁾	Valve slices	Solenoid coils	Inputs	Auxiliary power supply		Size	
				With	Without	CPA10	CPA14
CPA1x-GE-ASI-4 (-Z)	4	4	–	■	■	■	■
CPA1x-GE-ASI-4E4A-Z	4	4	4	■	■	■	■
CPA1x-GE-ASI-8E8A-Z	8	8	8	■	–	■	■

Permissible combinations in valve position allocation				
Type	Slave n			
	0	1	2	3
CPA1x-GE-ASI-4 (-Z)	M	M	M	M
	J	M	M	–
	M	J	M	–
	M	M	J	–
	J	M	Vacant position	–
	J	M	–	–
	M	J	–	–
	M	M	–	–
CPA1x-GE-ASI-4E4A (-Z)	M	M	M	M
	J	M	M	–
	M	J	M	–
	M	M	J	–
	J	M	Vacant position	–
	J	M	–	–
	M	J	–	–
	M	M	–	–

Permissible combinations in valve position allocation								
Type ¹⁾	Slave n plus slave n+1							
	0	1	2	3	4	5	6	7
CPA1x-GE-ASI-8E8A-Z	M	M	M	M	M	M	M	M
	J	M	M	M	M	M	M	–
	J	J	M	M	M	M	–	–

	M	M	J	M	M	J	–	–

	M	M	M	M	J	–	–	–
	M	M	M	M	Vacant position	–	–	–

	J	J	J	J	–	–	–	–

	J	M	–	–	–	–	–	–
	M	J	–	–	–	–	–	–
	M	M	–	–	–	–	–	–

- 1) - All valve slices can be freely configured (up to the maximum number of valve solenoids supported (4 or 8)).
 - A blanking plate can be used instead of the valve slice as a vacant position for one or two solenoid coils.
 M Valve slice with single solenoid valve or a different valve slice with an output.
 J Valve slice with double solenoid valve or a different valve slice with two outputs.

AS-interface® components

CPA valve terminal – Connection technology and addressing

FESTO

Installation: Selectable connection technology for AS-interface

Support for flat cables

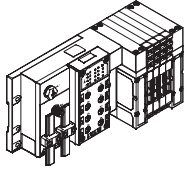

- Straightforward cabling with flat cables in protected areas
- Fast system of installation with standard AS-interface cables

Support for round cables

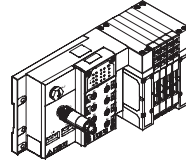

Local round cable wiring system for areas subjected to consistently high stress:

- Permanently high humidity
- Need for flexible cabling using one cable
- Use in energy chains with highly flexible cables

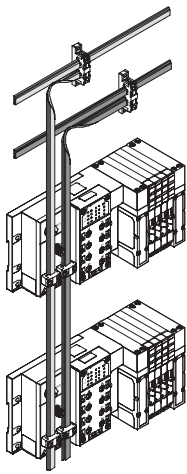

Standard installation at the AS-interface using flat cables

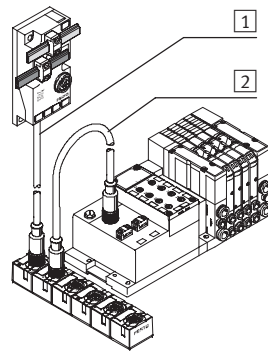

- 1 Pre-assembled M12 round cable, 1 m, polyurethane
- 2 Selectable cable for additional slave, for example highly flexible cable for energy chains or PVC cable for applications requiring resistance to detergents

Selectable connection technology for addressing

Addressing device

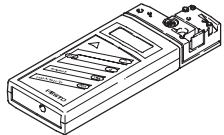

The addressing device to SPEC V2.1 can be used to scan the AS-interface from any point in the network. At all connected stations

- slave addresses can be read/changed
- ID and IO codes can be read out
- parameters can be read/changed
- input/output data can be read and written (setting outputs)
- error messages can be read out and quickly recognised

1 Addressing socket

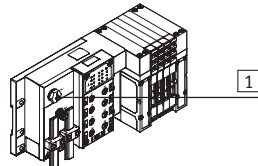

Only the connected chip is visible and addressable.

2 pins for chip 1 and 2, top right pin for chip 1.

2 M12 round plug

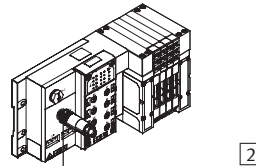

If the AS-interface is also connected to the flat cable plug, the entire network can be scanned without having to remove the slave from the bus.

3 Flat cable plug

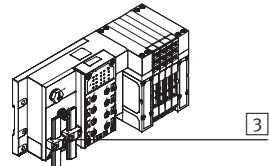

If the AS-interface is also connected to the M12 round cable, the entire network can be scanned without having to remove the slave from the bus.

-  - Note

If the valve terminal is connected using the external flat cable distributor and the M12 round plug, the

network can also be scanned and the valve terminal addressed via this connection.

AS-interface® components

CPA valve terminal – Connection technology and addressing

FESTO

AS-interface flat cable distributor to round cable 2x M12

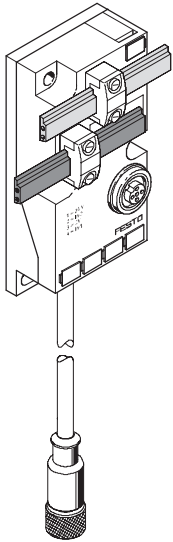

Alternative connection concepts

- AS-interface connection technology for yellow and optionally for black flat cables
- Passive conversion of the signals to M12 socket and round cable via M12 socket
- Pre-assembled round cable, PUR, 1 m long
- Alternatively PVC extension cable, 2.5 and 5 m, via additional M12 socket

Selecting the cable

Optimised connection technologies at the AS-interface can be easily realised by selecting the right cable.

- Flat cables for all standard applications with installation-saving insulation displacement technology
- Round cables for applications with differing requirements, for example:
 - Energy chains with small radii and further requirements for highly flexible cables
 - Applications with consistently high humidity

- Applications involving frequent cleaning and requiring cables resistant to detergents (PUR, PVC or other cables)
- Cabling systems using standard components (M12) preferred

Easy to mount

- Direct mounting on a wall or machine frame
- Direct mounting on the 40 mm ITEM profile
- Mounting on H-rail using adapter CP-TS-HS35

Supplementary compact I/O modules

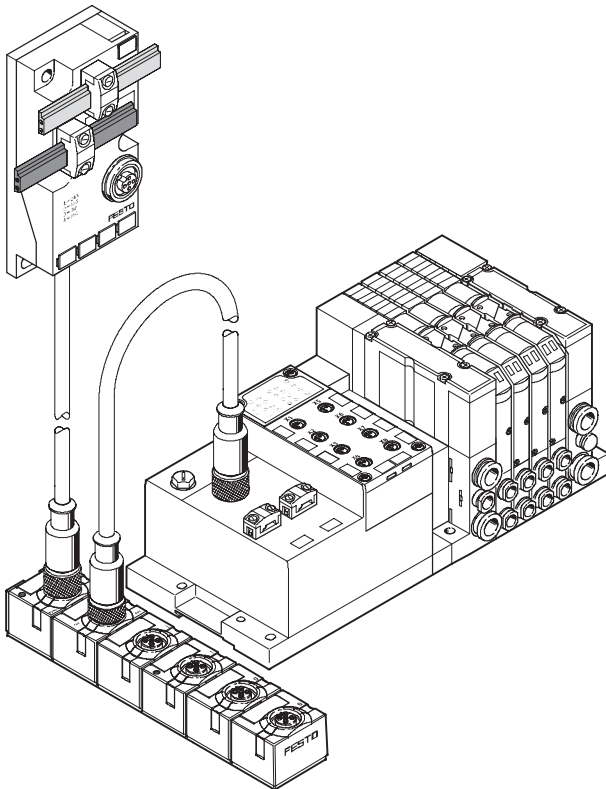

Valve terminals CPA can be supplemented with compact I/O modules and connected entirely using M12 round plugs. The following are available:

- 8 inputs M8
- 4 inputs/3 outputs M12
- 4 inputs/2 valve plugs

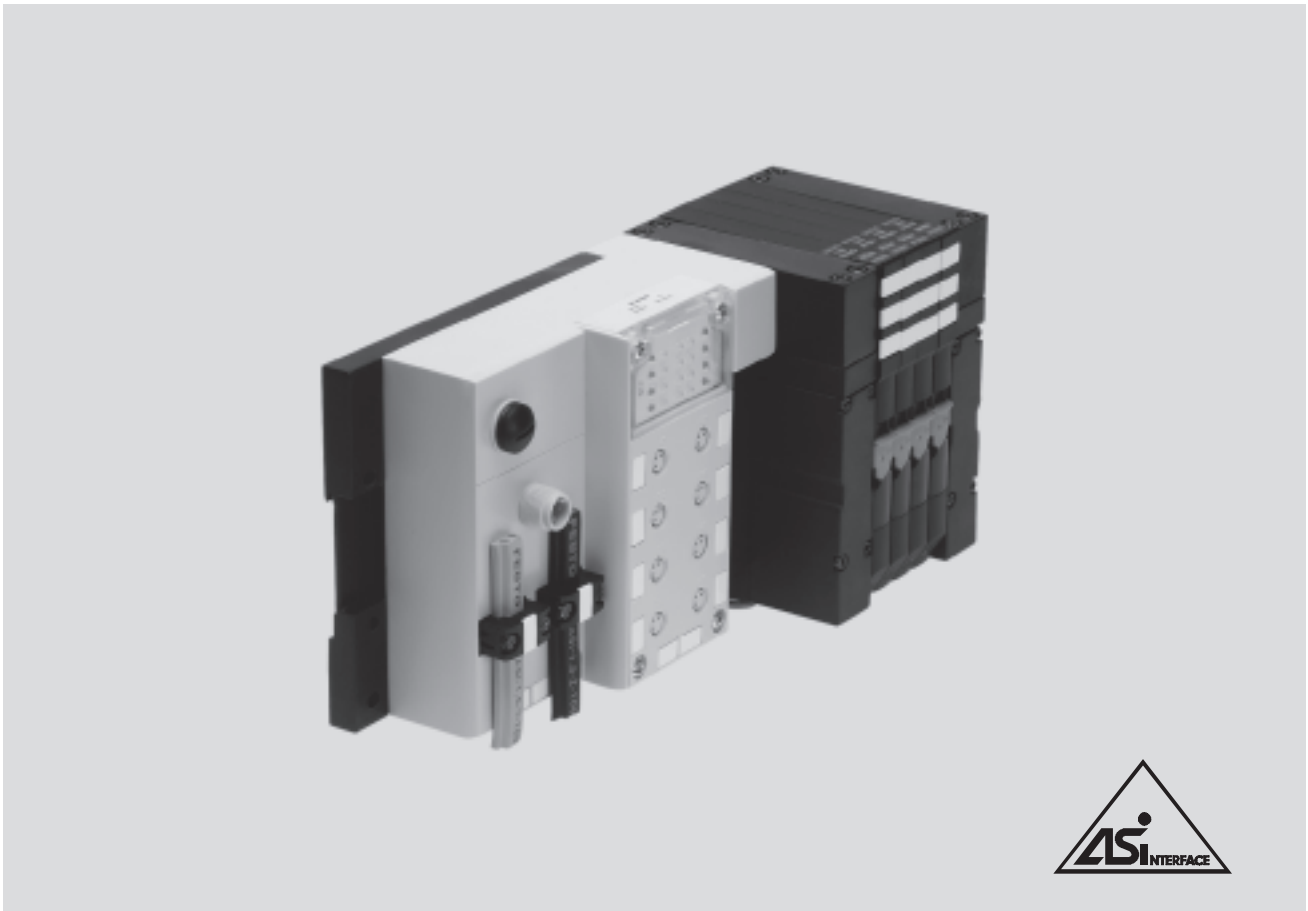

CPA valve terminal with inputs, to specification V2.1¹⁾

General data

- Modular design with exceptional performance and low weight
- Highly flexible thanks to various pneumatic functions (valve variants)
- Different pressure ranges
- Vacuum/low pressure operation
- Connection for auxiliary power supply for EMERGENCY-STOP conditions. The auxiliary power supply is always integrated in the version with inputs and can be subsequently switched off using the DIL switch
- Protection class IP65

- Selectable bus connection technology
 - Flat cable for AS-interface and auxiliary power supply
 - M12 round plug, 4-pin²⁾
- Selectable addressing
 - Via bus connection (M12 or flat cable)
 - Via addressing socket

LED displays for:

- Switching status displays of valves and inputs
- 24 V DC (AUX power)
- BUS
- FAULT-LED and enhanced diagnostics to SPEC V2.1¹⁾

Versions

- Width 10 and 14 mm
- 2 to 8 valve positions
- 4 or 8 inputs
- M12, M8, Harax, CageClamp or Sub-D connection technology
- Up to three pressure zones
- Suitable for vacuum/low pressure
- Various valve functions on one valve terminal, for example
 - 2x 3/2-way valve
 - 5/2-way valve, single solenoid
 - 5/2-way valve, double solenoid
 - 5/3-way valve
 - Separator plate
 - Vacant position

- Extensive mounting options, easy to extend/convert at a later date

Application

- Flexible and cost-effective connection of 2 to 8 valve positions
- Decentralised machine and system structures, for example
 - in handling technology
 - in conveyor technology
 - in the packaging industry
 - in sorting systems
 - suitable for energy chains thanks to connection via round cables

 Note

Please follow the links below for more details on the various pneumatic functions.

➔ Internet: type 12

1) Slave compatible with SPEC V3.0

2) Suitable cable distributor from flat cable to M12: ASI-KVT-FKx2-M12

AS-interface® components

CPA valve terminal with inputs, to SPEC V2.1

FESTO

Technical data				
Type	CPA-...-GE-ASI-4E4A-Z		CPA-...-GE-ASI-8E8A-Z	
Part No.	Order via order code/valve terminal configurator			
Valves	Number of solenoid coils	4		8
	Valve width [mm]	10/14		
	External power supply 24 V DC	Set using DIL switch		Yes
Inputs	No. of digital inputs	4		8
	Connection technology	5-pin M12, 3-pin M8, Harax, CageClamp, Sub-D		
	Sensor supply via AS-interface	Short circuit and overload proof		
	Sensor connection	2-wire and 3-wire sensors		
	Type	IEC 1131-2, type 02		
	Input circuitry	PNP (positive switching)		
AS-interface connection	Connection technology	<ul style="list-style-type: none"> AS-interface flat cable plug M12 connection²⁾ 		
	Voltage range [V DC]	26.5 ... 31.6, reverse polarity protected		
	Residual ripple [mVss]	20		
	Current consumption of inputs [mA]	Without auxiliary power supply	With auxiliary power supply	With auxiliary power supply
	Basic electronic load	<20	<20	<20
	Total input current	200	200	200
	Total current of valves	≤140 (≤65)	–	–
	Total current consumption	Max. 260	Max. 220	Max. 220
Addressing socket	Connection technology	Industrial standard		
	• Top right pin	Slave 1		Slave 1
	• Bottom left pin	Unused		Slave 2
Load voltage connection	Connection technology	<ul style="list-style-type: none"> AS-interface flat cable plug M12 connection²⁾ 		
	Voltage range [V DC]	20.4 ... 26.4		
	Residual ripple [Vss]	4		
	Current consumption of valves [mA]	CPA10/14	CPA10/14	CPA10/14
	• max. starting current (at 24 V)	No load voltage connection	≤140	≤280
	• starting current for 4 valves following current reduction (approx. 25 ms)		≤65	≤130
LED displays	ASI-LED	Green		
	AUX-PWR-LED	Green		
	FAULT-LED	Red		
	Inputs	Green		
	Valves	Yellow		
General data	Protection class (to EN 60529)	IP65 (fully assembled)		
	Electromagnetic compatibility	Tested to EN 55295:Oct. 1999, low voltage devices		
	CE mark	Yes, in accordance with EU Directive 89/336/EEC		
	Temperature range [°C]	Operation: –5 ... +50; storage/transport: –20 ... +70		
	Materials	Housing, adapter: polyamide; base plate, end plate: polyamide		
	Dimensions	➔ 34		
	Weight [g]	240 + valves		
AS-interface data	ID code	ID = F _H ; ID1 = F _H ¹⁾ ; ID2 = E _H		
	IO code	7 _H		
	Profile	S-7.FE		

1) Factory setting, set to 0_H by some programming devices (Spec. V2.1) when addressing the slave

2) Suitable cable distributor from flat cable to M12 ➔ 136
Pin allocation as for NEBU-M12G5-F-0,2-M12G4 ➔ 32

Combinations of connection blocks and electronics modules for inputs			
Connection blocks	Part No.	CPA-...-GE-ASI-8E8A-Z	CPA-...-GE-ASI-4E4A-Z
CPX-AB-4-M12x2-5POL	195 704	■	■
CPX-AB-8-M8-3POL	195 706	■	■
CPX-AB-8-KL-4POL	195 708	■	■
CPX-AB-1-Sub-BU-25POL	525 676	■	■
CPX-AB-4-HAR-4POL	525 636	■	■

Pin allocation					
Connection block inputs		CPA-...-GE-ASI-8E8A-Z		CPA-...-GE-ASI-4E4A-Z	
CPX-AB-4-M12X2-5POL					
	 X1	 X3	X1.1: 24 V _{SEN} X1.2: Input x+1 X1.3: 0 V _{SEN} X1.4: Input x X1.5: FE (earth)	X3.1: 24 V _{SEN} X3.2: Input x+5 X3.3: 0 V _{SEN} X3.4: Input x+4 X3.5: FE (earth)	X1.1: 24 V _{SEN} X1.2: Input x+1 X1.3: 0 V _{SEN} X1.4: Input x X1.5: FE (earth)
	 X2	 X4	X2.1: 24 V _{SEN} X2.2: Input x+3 X2.3: 0 V _{SEN} X2.4: Input x+2 X2.5: FE (earth)	X4.1: 24 V _{SEN} X4.2: Input x+7 X4.3: 0 V _{SEN} X4.4: Input x+6 X4.5: FE (earth)	X3.1: 24 V _{SEN} X3.2: Input x+3 X3.3: 0 V _{SEN} X3.4: Input x+2 X3.5: FE (earth)
CPX-AB-8-M8-3POL					
	 X1	 X5	X1.1: 24 V _{SEN} X1.3: 0 V _{SEN} X1.4: Input x	X5.1: 24 V _{SEN} X5.3: 0 V _{SEN} X5.4: Input x+4	X1.1: 24 V _{SEN} X1.3: 0 V _{SEN} X1.4: Input x
	 X2	 X6	X2.1: 24 V _{SEN} X2.3: 0 V _{SEN} X2.4: Input x+1	X6.1: 24 V _{SEN} X6.3: 0 V _{SEN} X6.4: Input x+5	X5.1: 24 V _{SEN} X5.3: 0 V _{SEN} X5.4: Input x+2
 X3	 X7	X3.1: 24 V _{SEN} X3.3: 0 V _{SEN} X3.4: Input x+2	X7.1: 24 V _{SEN} X7.3: 0 V _{SEN} X7.4: Input x+6	X2.1: 24 V _{SEN} X2.3: 0 V _{SEN} X2.4: Input x+1	
 X4	 X8	X4.1: 24 V _{SEN} X4.3: 0 V _{SEN} X4.4: Input x+3	X8.1: 24 V _{SEN} X8.3: 0 V _{SEN} X8.4: Input x+7	X3.1: 24 V _{SEN} X3.3: 0 V _{SEN} X3.4: Input x+1	
				X6.1: 24 V _{SEN} X6.3: 0 V _{SEN} X6.4: Input x+3	X7.1: 24 V _{SEN} X7.3: 0 V _{SEN} X7.4: Input x+3
				X4.1: 24 V _{SEN} X4.3: 0 V _{SEN} X4.4: Input x+3	X8.1: 24 V _{SEN} X8.3: 0 V _{SEN} X8.4: n.c.

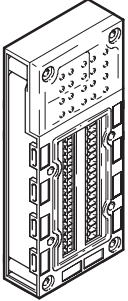
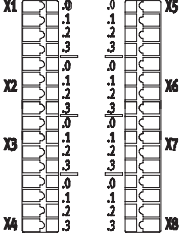
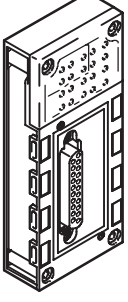
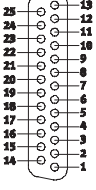
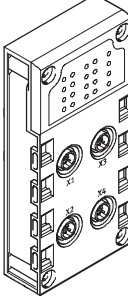
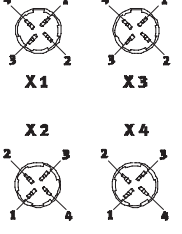
Pin allocation					
Connection block inputs		CPA-...-GE-ASI-8E8A-Z		CPA-...-GE-ASI-4E4A-Z	
CPX-AB-8-KL-4POL					
		X1.0: 24 V _{SEN} X1.1: 0 V _{SEN} X1.2: Input x X1.3: FE (earth)	X5.0: 24 V _{SEN} X5.1: 0 V _{SEN} X5.2: Input x+4 X5.3: FE (earth)	X1.0: 24 V _{SEN} X1.1: 0 V _{SEN} X1.2: Input x X1.3: FE (earth)	X5.0: 24 V _{SEN} X5.1: 0 V _{SEN} X5.2: Input x+2 X5.3: FE (earth)
		X2.0: 24 V _{SEN} X2.1: 0 V _{SEN} X2.2: Input x+1 X2.3: FE (earth)	X6.0: 24 V _{SEN} X6.1: 0 V _{SEN} X6.2: Input x+5 X6.3: FE (earth)	X2.0: 24 V _{SEN} X2.1: 0 V _{SEN} X2.2: Input x+1 X2.3: FE (earth)	X6.0: 24 V _{SEN} X6.1: 0 V _{SEN} X6.2: Input x+3 X6.3: FE (earth)
		X3.0: 24 V _{SEN} X3.1: 0 V _{SEN} X3.2: Input x+2 X3.3: FE (earth)	X7.0: 24 V _{SEN} X7.1: 0 V _{SEN} X7.2: Input x+6 X7.3: FE (earth)	X3.0: 24 V _{SEN} X3.1: 0 V _{SEN} X3.2: Input x+1 X3.3: FE (earth)	X7.0: 24 V _{SEN} X7.1: 0 V _{SEN} X7.2: Input x+3 X7.3: FE (earth)
		X4.0: 24 V _{SEN} X4.1: 0 V _{SEN} X4.2: Input x+3 X4.3: FE (earth)	X8.0: 24 V _{SEN} X8.1: 0 V _{SEN} X8.2: Input x+7 X8.3: FE (earth)	X4.0: 24 V _{SEN} X4.1: 0 V _{SEN} X4.2: n.c. X4.3: FE (earth)	X8.0: 24 V _{SEN} X8.1: 0 V _{SEN} X8.2: n.c. X8.3: FE (earth)
CPX-AB-1-SUB-BU-25POL					
		1: Input x 2: Input x+1 3: Input x+2 4: Input x+3 5: 24 V _{SEN} 6: 0 V _{SEN} 7: 24 V _{SEN} 8: 0 V _{SEN} 9: 24 V _{SEN} 10: 24 V _{SEN} 11: 0 V _{SEN} 12: 0 V _{SEN} 13: FE (earth)	14: Input x+4 15: Input x+5 16: Input x+6 17: Input x+7 18: 24 V _{SEN} 19: 24 V _{SEN} 20: 24 V _{SEN} 21: 24 V _{SEN} 22: 0 V _{SEN} 23: 0 V _{SEN} 24: 0 V _{SEN} 25: FE (earth) Socket: FE	1: Input x 2: Input x+1 3: Input x+1 4: n.c. 5: 24 V _{SEN} 6: 0 V _{SEN} 7: 24 V _{SEN} 8: 0 V _{SEN} 9: 24 V _{SEN} 10: 24 V _{SEN} 11: 0 V _{SEN} 12: 0 V _{SEN} 13: FE (earth)	14: Input x+2 15: Input x+3 16: Input x+3 17: n.c. 18: 24 V _{SEN} 19: 24 V _{SEN} 20: 24 V _{SEN} 21: 24 V _{SEN} 22: 0 V _{SEN} 23: 0 V _{SEN} 24: 0 V _{SEN} 25: FE (earth) Socket: FE
CPX-AB-4-HAR-4POL					
		X1.1: 24 V _{SEN} X1.2: Input x+1 X1.3: 0 V _{SEN} X1.4: Input x	X3.1: 24 V _{SEN} X3.2: Input x+5 X3.3: 0 V _{SEN} X3.4: Input x+4	X1.1: 24 V _{SEN} X1.2: Input x+1 X1.3: 0 V _{SEN} X1.4: Input x	X3.1: 24 V _{SEN} X3.2: Input x+3 X3.3: 0 V _{SEN} X3.4: Input x+2
		X2.1: 24 V _{SEN} X2.2: Input x+3 X2.3: 0 V _{SEN} X2.4: Input x+2	X4.1: 24 V _{SEN} X4.2: Input x+7 X4.3: 0 V _{SEN} X4.4: Input x+6	X2.1: 24 V _{SEN} X2.2: n.c. X2.3: 0 V _{SEN} X2.4: Input x+1	X4.1: 24 V _{SEN} X4.2: n.c. X4.3: 0 V _{SEN} X4.4: Input x+3

AS-interface[®] components

CPA valve terminal – Dimensions

FESTO

Dimensions

Download CAD data → www.festo.com

CPA with AS-interface

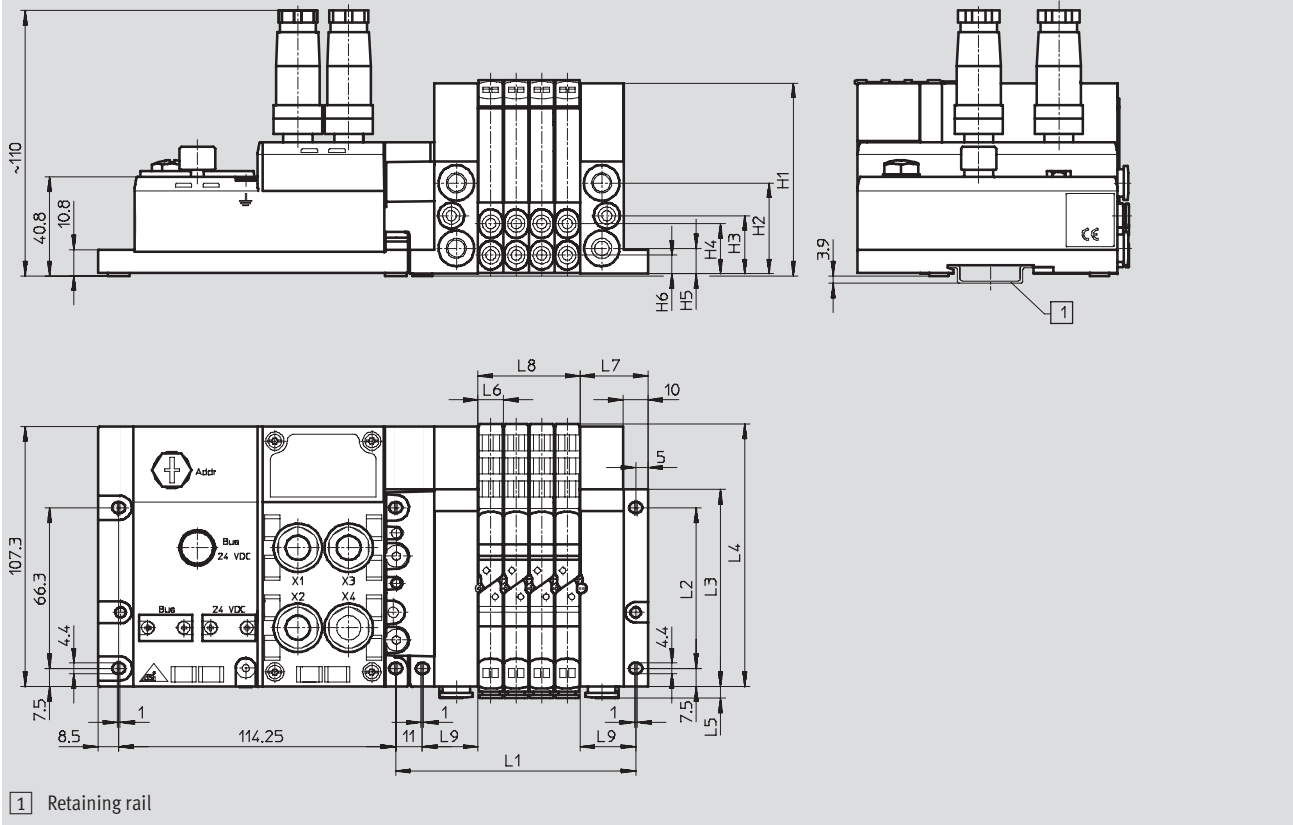

Type	L1 ¹⁾	L2	L3	L4	L5	L6	L7	L8 ¹⁾	L9	H1	H2	H3	H4	H5	H6
CPA10	46 + 11 + (n x 10.6)	66.3	81.3	108.3	5.5	10.6	28	n x 10.6	23	79.5	37.5	24	20.7	10.5	7.7
CPA14	52 + 11 + (n x 14.6)	76.1	91.1	118.1	6.5	14.6	31	n x 14.6	26	92	43	27.5	26.5	12	9.5









1) n = number of valves

Ordering data				
	Description		Type	Part No.
Bus connection				
	AS-interface flat cable, yellow	100 m	KASI-1,5-Y-100	18 940
	AS-interface flat cable, black	100 m	KASI-1,5-Z-100	18 941
	Flat cable blanking plug		ASI-SD-FK-BL	196 090
	AS-interface flat cable distributor	Parallel cable	ASI-KVT-FK	18 786
	AS-interface flat cable distributor	Symmetrical cable	ASI-KVT-FK-S	18 797
	Cable distributor (yellow and black)	Via 2x M12, 4-pin	ASI-KVT-FKx2-M12	527 474
	Cable cap for flat cable (scope of delivery 50 pieces)		ASI-KK-FK	18 787
	Cable sleeve (scope of delivery 20 pieces)		ASI-KT-FK	165 593
	M12 socket for flat cable		ASI-SD-FK-M12	18 788
	M12 socket for flat cable	With PG13.5 connector	ASI-SD-PG-M12	18 789
	M12 socket for round cable	With PG9, 5-pin connector	FBSD-GD-9-5POL	18 324
DUO plug				
	Plug M12 for 2 sensor cables	4-pin, PG11	SEA-GS-11-DUO	18 779
		5-pin, PG11	SEA-5GS-11-DUO	192 010
T-type plug connector				
	Plug M12, 2x socket M12 5-pin		NEDU-M12D5-M12T4	541 596
	Plug M8 3-pin, to M12 4-pin		NEDU-M8D3-M12T4	541 597

AS-interface® components

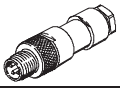
CPA valve terminal – Accessories

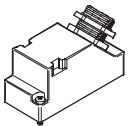

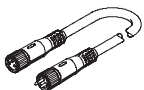
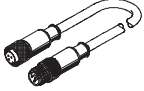
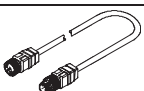
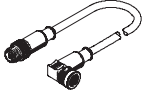
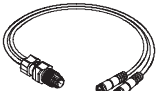



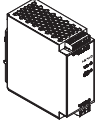
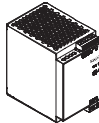
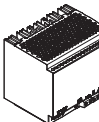

FESTO

Ordering data				
	Description		Type	Part No.
Sensor plugs				
	Straight sensor plug	M12, 4-pin, PG7	SEA-GS-7	18 666
	Straight sensor plug	M12, 5-pin, PG7	SEA-M12-5GS-PG7	175 487
	Straight sensor plug	M12, PG9 connector	SEA-GS-9	18 778
	Straight sensor plug for cable Ø 2.5 mm	M12, 4-pin	SEA-4GS-7-2,5	192 008
	Straight sensor plug	M8, screw-in, 3-pin	SEA-3GS-M8-S	192 009
	Straight sensor plug	M8, solderable, 3-pin	SEA-GS-M8	18 696
	Harax sensor plug	4-pin	SEA-GS-HAR-4POL	525 928
	Sub-D plug	25-pin	SD-SUB-D-ST25	527 522
	Protective cap	M12	ISK-M12	165 592
	Protective cap	M8	ISK-M8	177 672
Connecting cable				
	Modular system for connecting cables → Internet: nebu		NEBU-...	–
	Connecting cable, straight plug, straight socket	M8, 0.5 m	KM8-M8-GSGD-0,5	175 488
		M8, 1.0 m	KM8-M8-GSGD-1	175 489
		M8, 2.5 m	KM8-M8-GSGD-2,5	165 610
		M8, 5.0 m	KM8-M8-GSGD-5	165 611
	Connecting cable, straight plug, straight socket	M12, 4-pin/5-pin, 0.2 m	NEBU-M12G5-F-0.2-M12G4	542 129
		M12, 4-pin, 2.5 m	KM12-M12-GSGD-2,5	18 684
		M12, 4-pin, 5.0 m	KM12-M12-GSGD-5	18 686
	Connecting cable, straight plug, angled socket	M12, 4-pin, 1.0 m	KM12 M12-GSWD-1-4	185 499
	DUO cable M12 4-pin via 2xM8, 3-pin	2x straight socket	KM12-DUO-M8-GDGD	18 685
		2x straight/angled socket	KM12-DUO-M8-GDWD	18 688
		2x angled socket	KM12-DUO-M8-WDWD	18 687

AS-interface® components

CPA valve terminal – Accessories

FESTO

Ordering data				
	Description	Type	Part No.	
Miscellaneous				
	Primary switched mode modular power supply AS-i power supply 4.8 A	SVG-1/230VAC-ASI-5A	547 869	
	Primary switched mode modular power supply 24 VDC power supply 5 A	SVG-1/230-24VDC-5A	547 867	
	Primary switched mode modular power supply 24 VDC power supply 10 A	SVG-1/230-24VDC-10A	547 868	
	Addressing device (power supply plug included in scope of delivery)	ASI-PRG-ADR	18 959	
	Addressing cable	KASI-ADR	18 960	
	AS-interface input module for 8 inputs M8, compact	ASI-8DI-M8-3POL	542 124	
	AS-interface input/output module for 4 inputs/3 outputs M12, compact	ASI-4DI3DO-M12X2-5POL-Z	542 125	
	Inscription labels 6x10mm in frames (64pieces)	IBS 6x10	18 576	
	Inscription labels 9x20mm in frames (20 pieces)	IBS 9x20	18 182	
	H-rail to EN 60715	NRH-35-2000	35 430	
	H-rail mounting	CPA-BG-NRH	173 498	
User's manual				
	CPA Pneumatics Description	German	P.BE-CPA-DE	173 514
		English	P.BE-CPA-EN	173 515
		French	P.BE-CPA-FR	173 516
		Italian	P.BE-CPA-IT	173 518
		Spanish	P.BE-CPA-ES	173 517
		Swedish	P.BE-CPA-SV	173 519

AS-interface® components

MPA valve terminal – Overview

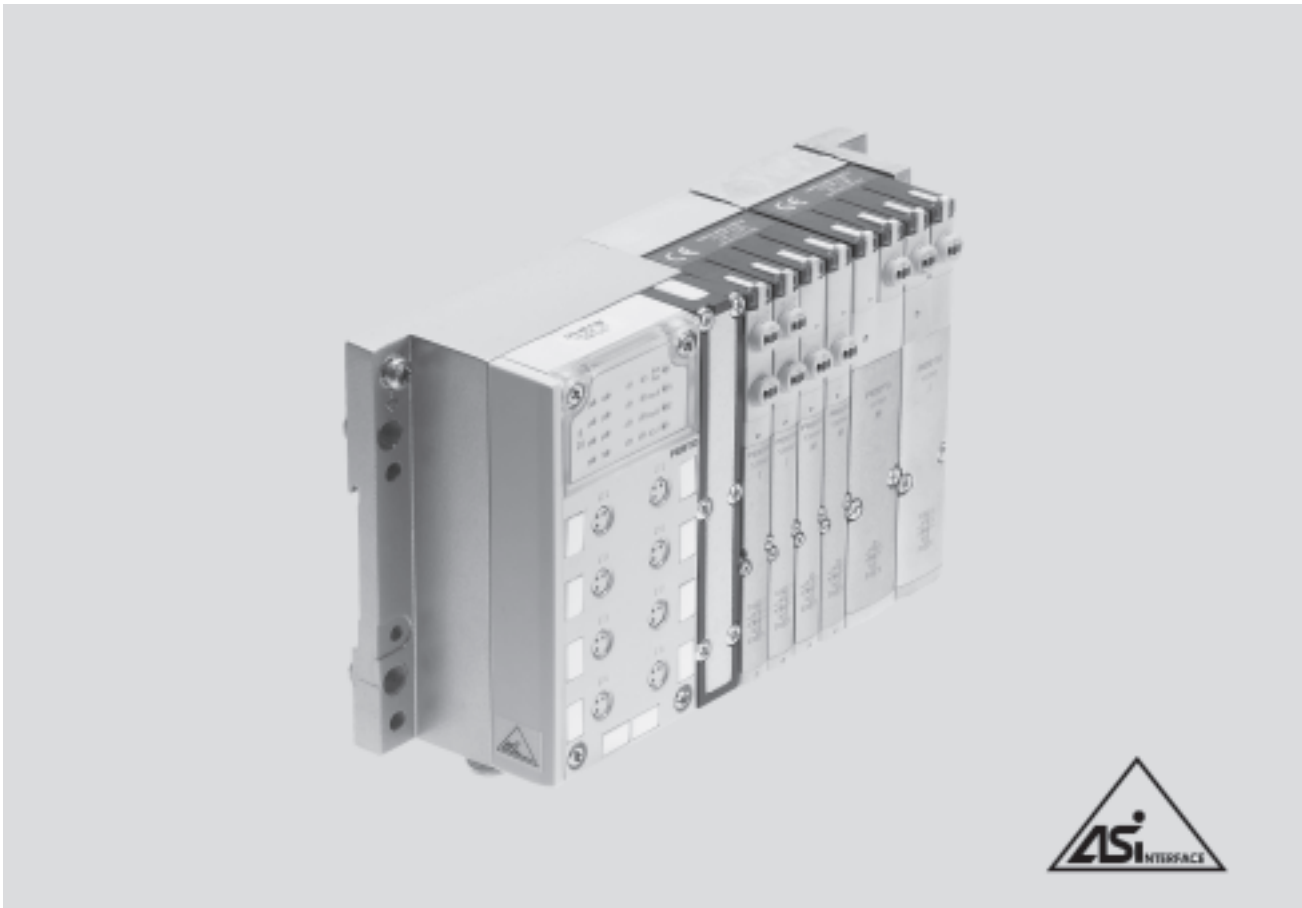

MPA valve terminals with AS-interface – Valve configuration options

MPA valve terminals with AS-interface can be flexibly configured with a wide range of valves. The system supports a maximum of 8 outputs (solenoid coils) and 8 inputs per valve terminal. This gives the following basic valve configuration options (see tables on following page).

 **Note**

Please follow the link below for more details on the various pneumatic functions.
 → Internet: type 32

General data

- Solutions with integrated inputs
- Width 10 or 20 mm
- With or without 24 V DC auxiliary power supply for solenoid coils (EMERGENCY-STOP circuitry) in the case of the 4I/4O version. The auxiliary power supply is always integrated in the version with 8 inputs and cannot be subsequently switched off using the DIL switch
- Selectable bus connection technology
 - Flat cable for AS-interface with 4I/4O version
 - 4-pin M12 round plug¹⁾ with 4I/4O and 8I/8O version
- Selectable addressing
 - Via bus connection (M12 or flat cable)

Versions

- 2 to 8 valves, freely configurable
- With 4 or 8 inputs
- M12, M8, quick connection, tension spring or Sub-D connection technology
- Separating seals for the creation of pressure zones
- Suitable for vacuum
- Subsequent extensions either
 - via unused valve positions
 - by converting the valve terminal

Application

- Flexible and cost-effective connection of 2 or 8 valves (max. 8 solenoid coils) with input feedback
- Decentralised machine and system structures, for example
 - in handling technology
 - in conveyor technology
 - in the packaging industry
 - in sorting systems
 - suitable for energy chains thanks to connection via round cables

1) Suitable cable distributor from flat cable to M12: ASI-KVT-FKx2-M12

AS-interface® components

MPA valve terminal – Connection technology and addressing

FESTO

Types of valve terminal with AS-interface							
Type ¹⁾	Valves	Solenoid coils	Inputs	Auxiliary power supply can be disconnected		Width	
				Yes	No	10 mm	20 mm
VMPA-ASI-EPL-E-4E4A-Z	4	4	4	■	–	■	■
VMPA-ASI-EPL-G-4E4A-Z	4	4	4	■	–	■	■
VMPA-ASI-EPL-EU-4E4A-Z	4	4	4	■	–	■	■
VMPA-ASI-EPL-GU-4E4A-Z	4	4	4	■	–	■	■
VMPA-ASI-EPL-E-8E8A-Z	8	8	8	–	■	■	■
VMPA-ASI-EPL-G-8E8A-Z	8	8	8	–	■	■	■
VMPA-ASI-EPL-EU-8E8A-Z	8	8	8	–	■	■	■
VMPA-ASI-EPL-GU-8E8A-Z	8	8	8	–	■	■	■

Permissible combinations in valve position allocation				
Type	Slave n			
	0	1	2	3
4l/4O MPA1 - only M (up to 4 valves per sub-base)	M	M	M	M
	M	M	M	L
	M	M	L	L
	M	L	L	L
4l/4O MPA2 (2 valves per sub-base)	M	M	M	M
	J	M	–	–
	M	J	–	–
	J	J	–	–

Permissible combinations in valve position allocation								
Type	Slave n plus slave n+1							
	0	1	2	3	4	5	6	7
8l/8O MPA1 (up to 4 valves per sub-base)	M	M	M	M	M	M	M	M
	M	M	M	L	M	M	M	L
	J	J	J	J	–	–	–	–

	J	J	J	J	–	–	–	–
	J	J	J	M	–	–	–	–
	J	J	M	M	–	–	–	–

	J	J	L	L	–	–	–	–
8l/8O MPA2 (2 valves per sub-base)	M	M	M	M	M	M	M	M
	M	M	M	L	M	M	M	L

	J	J	J	J	–	–	–	–
	J	J	J	M	–	–	–	–
	J	J	M	M	–	–	–	–

	J	J	M	M	M	M	–	–
	J	J	M	M	M	L	–	–

M	M	M	M	J	J	–	–	

AS-interface® components

MPA valve terminal – Connection technology and addressing

Installation: Selectable connection technology for AS-interface

Support for flat cables

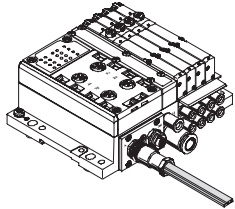

- Straightforward cabling with flat cables in protected areas
- Fast system of installation with standard AS-interface cables
- Standard installation at the AS-interface with yellow flat cables is possible with the 4I/4O MPA version

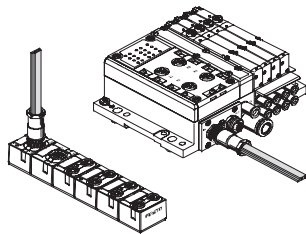

Standard installation at the AS-interface flat cable

Support for round cables

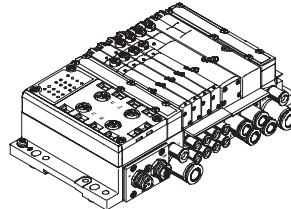

Local round cable wiring system for areas subjected to consistently high stress:

- Permanently high humidity
- Need for flexible cabling using one cable
- Use in energy chains with highly flexible cables

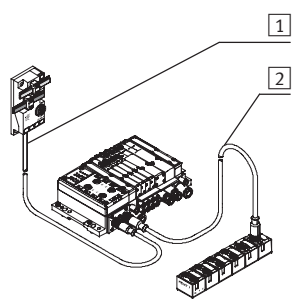

- 1 Pre-assembled M12 round cable, 1 m, polyurethane
- 2 Selectable cable for additional slave, for example highly flexible cable for energy chains or PVC cable for applications requiring resistance to detergents

Addressing

Addressing device

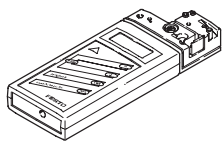

The addressing device to SPEC V2.1 can be used to scan the AS-interface from any point in the network. At all connected stations

- slave addresses can be read/changed
- ID and IO codes can be read out
- parameters can be read/changed
- input/output data can be read and written (setting outputs)
- error messages can be read out and quickly recognised

AS-interface connections

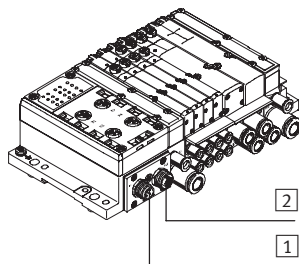

- 1 M12 plug for AS-interface and incoming auxiliary supply
- 2 M12 socket for AS-interface and outgoing auxiliary supply

AS-interface® components

MPA valve terminal – Connection technology and addressing

AS-interface flat cable distributor to round cable 2x M12

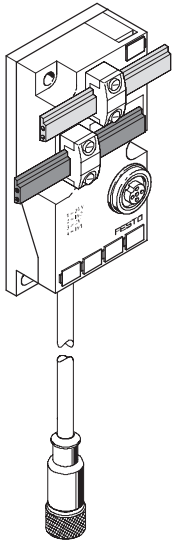

Alternative connection concepts

- AS-interface connection technology for yellow and optionally for black flat cables
- Passive conversion of the signals to M12 socket and round cable via M12 socket
- Pre-assembled round cable, PUR, 1 m long
- Alternatively PVC extension cable, 2.5 and 5 m, via additional M12 socket

Selecting the cable

Optimised connection technologies at the AS-interface can be easily realised by selecting the right cable.

- Flat cables for all standard applications with installation-saving insulation displacement technology
- Round cables for applications with differing requirements, for example:
 - Energy chains with small radii and further requirements for highly flexible cables
 - Applications with consistently high humidity

- Applications involving frequent cleaning and requiring cables resistant to detergents (PUR, PVC or other cables)
- Cabling systems using standard components (M12) preferred

Easy to mount

- Direct mounting on a wall or machine frame
- Direct mounting on the 40 mm ITEM profile
- Mounting on H-rail using adapter CP-TS-HS35

Supplementary compact I/O modules

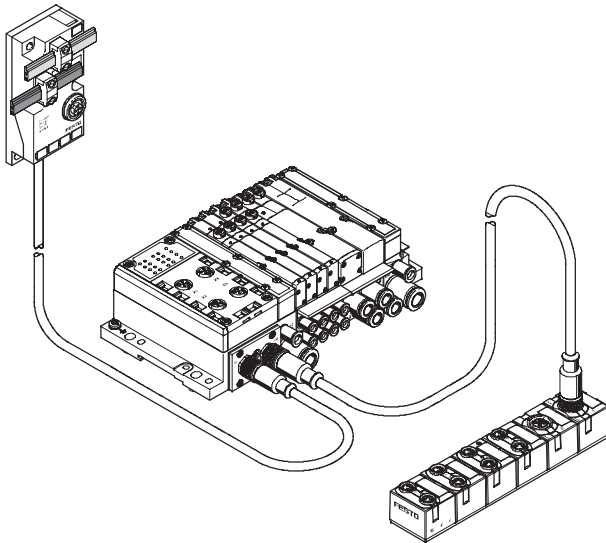

The valve terminals MPA can be supplemented with the compact I/O modules. The following are available:

- 8 inputs M8
- 4 inputs/3 outputs M12
- 4 inputs/2 valve plugs

AS-interface® components

Key features – Display and operation

Display and operation

Each valve solenoid coil is allocated an LED which indicates its signal status.

- Indicator 12 shows the switching status of the coil for output 2
- Indicator 14 shows the switching status of the coil for output 4

Manual override

The manual override (MO) enables the valve to be actuated when not electrically activated or energised. The valve is activated by pushing the manual override. The set switching status can also be locked by turning

the manual override (code R or as accessory).

Alternatives:

- A cover (code N or as accessory) can be fitted over the manual override to prevent it from being locked. The

manual override can then only be activated by pushing it.

- A cover (code V) can be fitted over the manual override to prevent it from being accidentally activated.

Pneumatic connection and control elements

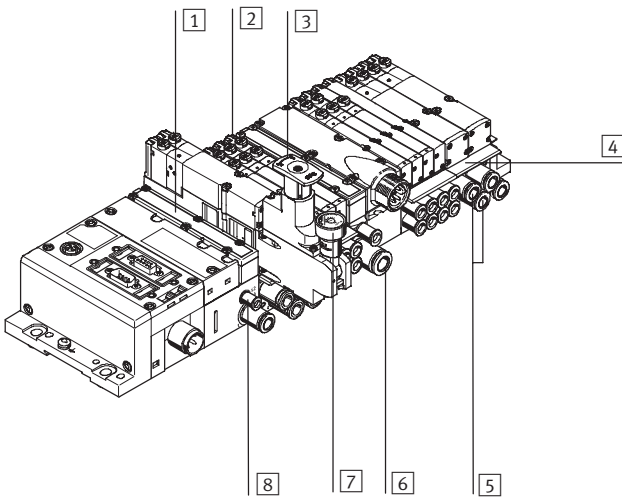

- 1 Flat plate silencer exhaust air 3/5
- 2 Manual override (for each pilot solenoid coil, non-detenting or detenting)
- 3 Adjusting knob for optional pressure regulator plate
- 4 Inscription label holder for sub-base
- 5 Working ports 2 and 4, for each valve position
- 6 Supply port 1
- 7 Pressure gauge (optional)
- 8 Ports 12 and 14 for supplying external pilot air

 **Note**
A manually actuated valve (manual override) cannot be reset electrically. Conversely, an electrically actuated valve cannot be reset using the mechanical manual override.

Electrical connection and display components AS-interface

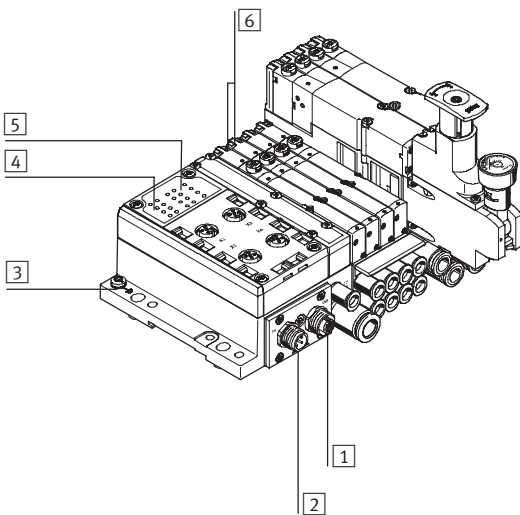

- 1 M12 socket AS-interface bus and additional supply (AS-i Out)
- 2 M12 plug AS-interface bus and additional supply (AS-i In)
- 3 Earth terminal
- 4 Status LEDs inputs
- 5 Status LEDs AS-interface
- 6 Diagnostic LEDs valves

AS-interface® components

MPA valve terminal

FESTO

Technical data				
Type	VMPA-ASI-EPL-...-4E4A-Z			VMPA-ASI-EPL-...-8E8A-Z
Part No.	Order via order code/valve terminal configurator			
Valves	Number of solenoid coils	4		
	Valve width [mm]	10/20		
	External power supply 24 V DC	Set using DIL switch		Yes
Inputs	No. of digital inputs	4		8
	Connection technology	5-pin M12, 3-pin M8, Harax, CageClamp, Sub-D		
	Sensor supply via AS-interface	Short circuit and overload proof		
	Sensor connection	2-wire and 3-wire sensors		
	Type	IEC 1131-2, type 02		
	Input circuitry	PNP (positive switching)		
AS-interface connection	Connection technology	M12 connection ²⁾		
	Voltage range [V DC]	26.5 ... 31.6, reverse polarity protected		
	Residual ripple [mVss]	20		
	Current consumption of inputs	Without auxiliary power supply	With auxiliary power supply	With auxiliary power supply
	Basic electronic load	≤25	≤25	≤25
	Total input current	350	350	350
	Total output current (valves incl. LED) [mA]	MPA1: 270 MPA2: 533	MPA1: 540 MPA2: 1065	
Load voltage connection	Connection technology	M12 connection ²⁾		
	Voltage range [V DC]	21.6 ... 26.4		
	Residual ripple [Vss]	4		
Current consumption of valves per solenoid coil	• Max. starting current (at 24 V) [mA]	MPA1: ≤80 MPA2: ≤100		
	• Following current reduction (approx. 25 ms) [mA]	MPA1: ≤25 MPA2: ≤20		
LED displays	ASI-LED	Green		
	AUX-PWR-LED	Green		
	FAULT-LED	Red		
	Inputs	Green		
	Valves	Yellow		
General data	Protection class (to EN 60529)	IP65 (fully assembled)		
	CE mark	Yes, in accordance with EU Directive 89/336/EEC		
	Temperature range [°C]	Operation: -5 ... +50; storage/transport: -20 ... +40		
	Materials	Sub-base, right-hand end plate: die-cast aluminium; left-hand end plate: die-cast aluminium, polyamide		
	Dimensions	→ 46		
	Weight [g]	AS-interface: 360 (silencer), 369 (exhaust plate)		
AS-interface data	ID code	ID = F _H ; ID1 = F _H ¹⁾ ; ID2 = E _H		
	IO code	7 _H		
	Profile	S-7.F.E		

1) Factory setting, set to 0_H by some programming devices (Spec. V2.1) when addressing the slave

2) Suitable cable distributor from flat cable to M12 → 136
Pin allocation as for NEBU-M12G5-F-0,2-M12G4 → 44

Combinations of connection blocks and electronics modules for inputs

Connection blocks	Part No.	VMPA-ASI-EPL-...-8E8A-Z	VMPA-ASI-EPL-...-4E4A-Z
CPX-AB-4-M12x2-5P-M3	546 996	■	■
CPX-AB-8-M8-3P-M3	546 998	■	■
CPX-AB-8-KL-4P-M3	546 999	■	■
CPX-AB-1-Sub-BU-25P-M3	547 000	■	■
CPX-AB-4-HAR-4P-M3	547 001	■	■

Pin allocation

Connection block inputs		VMPA-ASI-EPL-...-8E8A-Z	VMPA-ASI-EPL-...-4E4A-Z
CPX-AB-4-M12X2-5P-M3			
	<p>X1</p>	<p>X1.1: 24 V_{SEN} X1.2: Input x+1 X1.3: 0 V_{SEN} X1.4: Input x X1.5: FE (earth)</p>	<p>X3.1: 24 V_{SEN} X3.2: Input x+5 X3.3: 0 V_{SEN} X3.4: Input x+4 X3.5: FE (earth)</p>
	<p>X2</p>	<p>X2.1: 24 V_{SEN} X2.2: Input x+3 X2.3: 0 V_{SEN} X2.4: Input x+2 X2.5: FE (earth)</p>	<p>X4.1: 24 V_{SEN} X4.2: Input x+7 X4.3: 0 V_{SEN} X4.4: Input x+6 X4.5: FE (earth)</p>
CPX-AB-8-M8-3P-M3			
	<p>X1</p>	<p>X1.1: 24 V_{SEN} X1.3: 0 V_{SEN} X1.4: Input x</p>	<p>X5.1: 24 V_{SEN} X5.3: 0 V_{SEN} X5.4: Input x+4</p>
	<p>X2</p>	<p>X2.1: 24 V_{SEN} X2.3: 0 V_{SEN} X2.4: Input x+1</p>	<p>X6.1: 24 V_{SEN} X6.3: 0 V_{SEN} X6.4: Input x+5</p>
	<p>X3</p>	<p>X3.1: 24 V_{SEN} X3.3: 0 V_{SEN} X3.4: Input x+2</p>	<p>X7.1: 24 V_{SEN} X7.3: 0 V_{SEN} X7.4: Input x+6</p>
	<p>X4</p>	<p>X4.1: 24 V_{SEN} X4.3: 0 V_{SEN} X4.4: Input x+3</p>	<p>X8.1: 24 V_{SEN} X8.3: 0 V_{SEN} X8.4: n.c.</p>

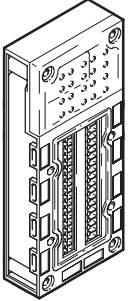
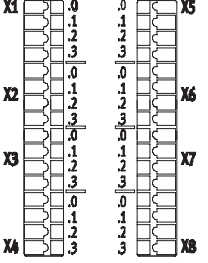
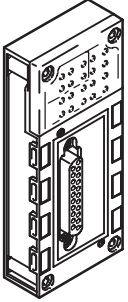
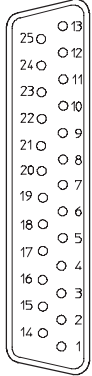
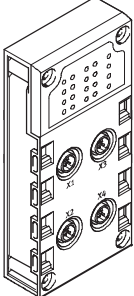
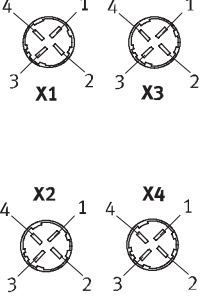
Pin allocation					
Connection block inputs		VMPA-ASI-EPL-...-8E8A-Z		VMPA-ASI-EPL-...-4E4A-Z	
CPX-AB-8-KL-4P-M3					
		X1.0: 24 V _{SEN} X1.1: 0 V _{SEN} X1.2: Input x X1.3: FE (earth) X2.0: 24 V _{SEN} X2.1: 0 V _{SEN} X2.2: Input x+1 X2.3: FE (earth) X3.0: 24 V _{SEN} X3.1: 0 V _{SEN} X3.2: Input x+2 X3.3: FE (earth) X4.0: 24 V _{SEN} X4.1: 0 V _{SEN} X4.2: Input x+3 X4.3: FE (earth)	X5.0: 24 V _{SEN} X5.1: 0 V _{SEN} X5.2: Input x+4 X5.3: FE (earth) X6.0: 24 V _{SEN} X6.1: 0 V _{SEN} X6.2: Input x+5 X6.3: FE (earth) X7.0: 24 V _{SEN} X7.1: 0 V _{SEN} X7.2: Input x+6 X7.3: FE (earth) X8.0: 24 V _{SEN} X8.1: 0 V _{SEN} X8.2: Input x+7 X8.3: FE (earth)	X1.0: 24 V _{SEN} X1.1: 0 V _{SEN} X1.2: Input x X1.3: FE (earth) X2.0: 24 V _{SEN} X2.1: 0 V _{SEN} X2.2: Input x+1 X2.3: FE (earth) X3.0: 24 V _{SEN} X3.1: 0 V _{SEN} X3.2: Input x+1 X3.3: FE (earth) X4.0: 24 V _{SEN} X4.1: 0 V _{SEN} X4.2: n.c. X4.3: FE (earth)	X5.0: 24 V _{SEN} X5.1: 0 V _{SEN} X5.2: Input x+2 X5.3: FE (earth) X6.0: 24 V _{SEN} X6.1: 0 V _{SEN} X6.2: Input x+3 X6.3: FE (earth) X7.0: 24 V _{SEN} X7.1: 0 V _{SEN} X7.2: Input x+3 X7.3: FE (earth) X8.0: 24 V _{SEN} X8.1: 0 V _{SEN} X8.2: n.c. X8.3: FE (earth)
CPX-AB-1-SUB-BU-25P-M3					
		1: Input x 2: Input x+1 3: Input x+2 4: Input x+3 5: 24 V _{SEN} 6: 0 V _{SEN} 7: 24 V _{SEN} 8: 0 V _{SEN} 9: 24 V _{SEN} 10: 24 V _{SEN} 11: 0 V _{SEN} 12: 0 V _{SEN} 13: FE (earth)	14: Input x+4 15: Input x+5 16: Input x+6 17: Input x+7 18: 24 V _{SEN} 19: 24 V _{SEN} 20: 24 V _{SEN} 21: 24 V _{SEN} 22: 0 V _{SEN} 23: 0 V _{SEN} 24: 0 V _{SEN} 25: FE (earth) Socket: FE	1: Input x 2: Input x+1 3: Input x+1 4: n.c. 5: 24 V _{SEN} 6: 0 V _{SEN} 7: 24 V _{SEN} 8: 0 V _{SEN} 9: 24 V _{SEN} 10: 24 V _{SEN} 11: 0 V _{SEN} 12: 0 V _{SEN} 13: FE (earth)	14: Input x+2 15: Input x+3 16: Input x+3 17: n.c. 18: 24 V _{SEN} 19: 24 V _{SEN} 20: 24 V _{SEN} 21: 24 V _{SEN} 22: 0 V _{SEN} 23: 0 V _{SEN} 24: 0 V _{SEN} 25: FE (earth) Socket: FE
CPX-AB-4-HAR-4P-M3					
		X1.1: 24 V _{SEN} X1.2: Input x+1 X1.3: 0 V _{SEN} X1.4: Input x X2.1: 24 V _{SEN} X2.2: Input x+3 X2.3: 0 V _{SEN} X2.4: Input x+2	X3.1: 24 V _{SEN} X3.2: Input x+5 X3.3: 0 V _{SEN} X3.4: Input x+4 X4.1: 24 V _{SEN} X4.2: Input x+7 X4.3: 0 V _{SEN} X4.4: Input x+6	X1.1: 24 V _{SEN} X1.2: Input x+1 X1.3: 0 V _{SEN} X1.4: Input x X2.1: 24 V _{SEN} X2.2: n.c. X2.3: 0 V _{SEN} X2.4: Input x+1	X3.1: 24 V _{SEN} X3.2: Input x+3 X3.3: 0 V _{SEN} X3.4: Input x+2 X4.1: 24 V _{SEN} X4.2: n.c. X4.3: 0 V _{SEN} X4.4: Input x+3

AS-interface[®] components

MPA valve terminal – Dimensions

FESTO

Dimensions



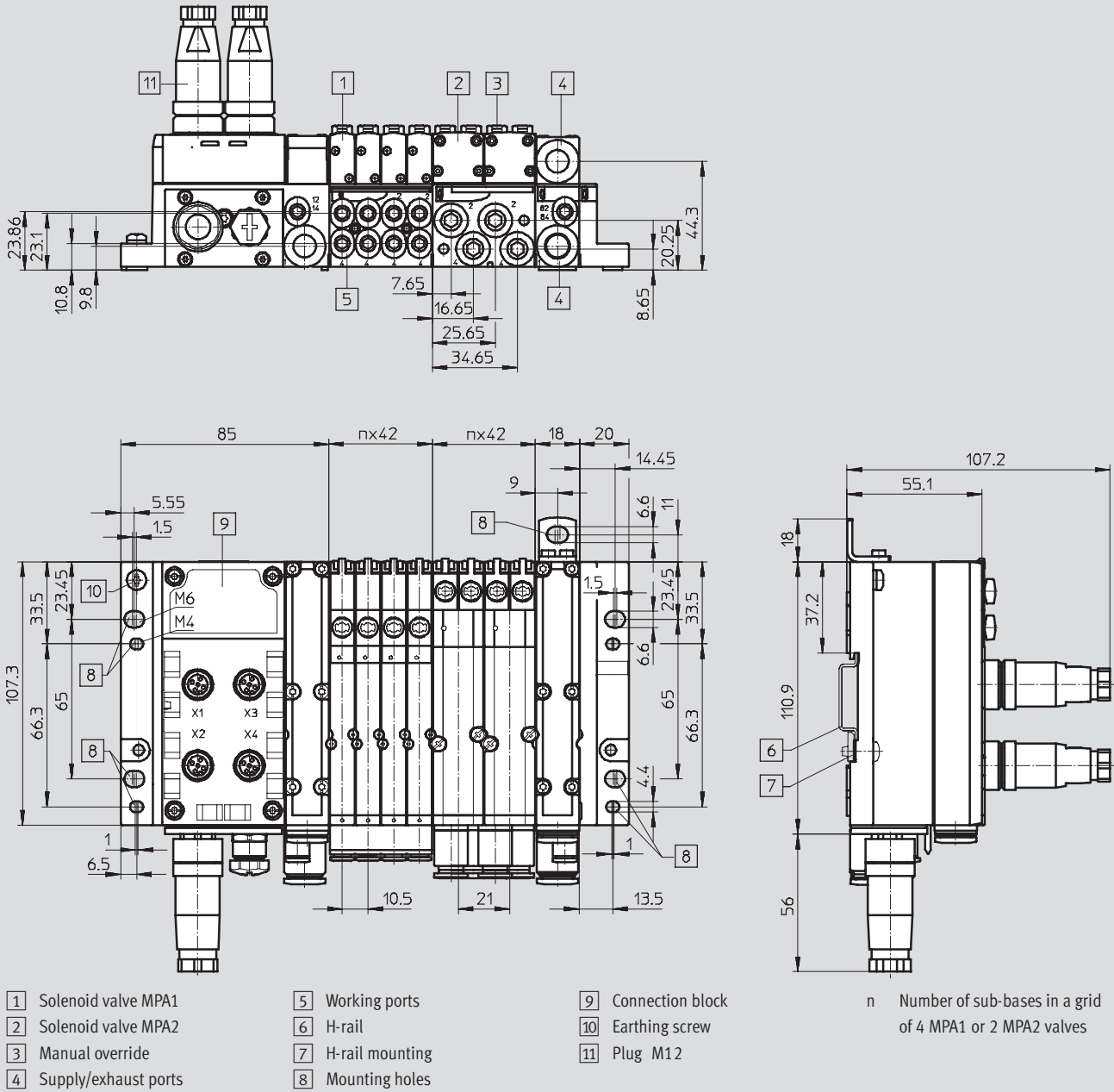



Download CAD data → www.festo.com

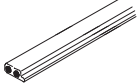

AS-interface® components

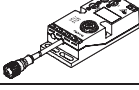
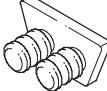
MPA valve terminal – Accessories

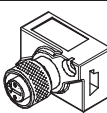
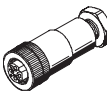
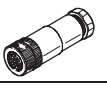

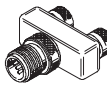









FESTO

Ordering data				
	Description		Type	Part No.
Bus connection				
	AS-interface flat cable, yellow	100 m	KASI-1,5-Y-100	18 940
	AS-interface flat cable, black	100 m	KASI-1,5-Z-100	18 941
	Flat cable blanking plug		ASI-SD-FK-BL	196 090
	AS-interface flat cable distributor	Parallel cable	ASI-KVT-FK	18 786
	AS-interface flat cable distributor	Symmetrical cable	ASI-KVT-FK-S	18 797
	Cable distributor (yellow and black)	Via 2x M12, 4-pin	ASI-KVT-FKx2-M12	527 474
	Cable cap for flat cable (scope of delivery 50 pieces)		ASI-KK-FK	18 787
	Cable sleeve (scope of delivery 20 pieces)		ASI-KT-FK	165 593
	M12 socket for flat cable		ASI-SD-FK-M12	18 788
	M12 socket for flat cable	With PG13.5 connector	ASI-SD-PG-M12	18 789
	M12 socket for round cable	With PG9, 5-pin connector	FBSD-GD-9-5POL	18 324
DUO plug				
	Plug M12 for 2 sensor cables	4-pin, PG11	SEA-GS-11-DUO	18 779
		5-pin, PG11	SEA-5GS-11-DUO	192 010
T-type plug connector				
	Plug M12, 2x socket M12 5-pin		NEDU-M12D5-M12T4	541 596
	Plug M8 3-pin, to M12 4-pin		NEDU-M8D3-M12T4	541 597

AS-interface® components

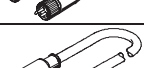
MPA valve terminal – Accessories

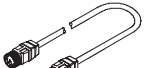





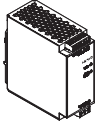
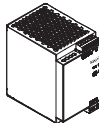
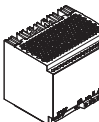

FESTO

Ordering data				
	Description		Type	Part No.
Sensor plugs				
	Straight sensor plug	M12, 4-pin, PG7	SEA-GS-7	18 666
	Straight sensor plug	M12, 5-pin, PG7	SEA-M12-5GS-PG7	175 487
	Straight sensor plug	M12, PG9 connector	SEA-GS-9	18 778
	Straight sensor plug for cable Ø 2.5 mm	M12, 4-pin	SEA-4GS-7-2,5	192 008
	Straight sensor plug	M8, screw-in, 3-pin	SEA-3GS-M8-S	192 009
	Straight sensor plug	M8, solderable, 3-pin	SEA-GS-M8	18 696
	Harax sensor plug	4-pin	SEA-GS-HAR-4POL	525 928
	Sub-D plug	25-pin	SD-SUB-D-ST25	527 522
	Protective cap	M12	ISK-M12	165 592
		M8	ISK-M8	177 672
Connecting cables				
	Modular system for connecting cables → Internet: nebu		NEBU-...	–
	Connecting cable, straight plug, straight socket	M8, 0.5 m	KM8-M8-GSGD-0,5	175 488
		M8, 1.0 m	KM8-M8-GSGD-1	175 489
		M8, 2.5 m	KM8-M8-GSGD-2,5	165 610
		M8, 5.0 m	KM8-M8-GSGD-5	165 611
	Connecting cable, straight plug, straight socket	M12, 4-pin/5-pin, 0.2 m	NEBU-M12G5-F-0.2-M12G4	542 129
		M12, 4-pin, 2.5 m	KM12-M12-GSGD-2,5	18 684
		M12, 4-pin, 5.0 m	KM12-M12-GSGD-5	18 686
	Connecting cable, straight plug, angled socket	M12, 4-pin, 1.0 m	KM12 M12-GSWD-1-4	185 499
	DUO cable M12 4-pin via 2xM8, 3-pin	2x straight socket	KM12-DUO-M8-GDGD	18 685
		2x straight/angled socket	KM12-DUO-M8-GDWD	18 688
		2x angled socket	KM12-DUO-M8-WDWD	18 687

AS-interface® components

MPA valve terminal – Accessories

FESTO

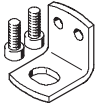
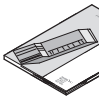
Ordering data				
	Description	Type	Part No.	
Miscellaneous				
	Primary switched mode modular power supply AS-i power supply 4.8 A	SVG-1/230VAC-ASI-5A	547 869	
	Primary switched mode modular power supply 24 VDC power supply 5 A	SVG-1/230-24VDC-5A	547 867	
	Primary switched mode modular power supply 24 VDC power supply 10 A	SVG-1/230-24VDC-10A	547 868	
	Addressing device (power supply plug included in scope of delivery)	ASI-PRG-ADR	18 959	
	Addressing cable	KASI-ADR	18 960	
	AS-interface input module for 8 inputs M8, compact	ASI-8DI-M8-3POL	542 124	
	AS-interface input/output module for 4 inputs/3 outputs M12, compact	ASI-4DI3DO-M12X2-5POL-Z	542 125	
	Inscription labels 6x10mm in frames (64pieces)	IBS 6x10	18 576	
	Inscription label holder for connection block, transparent, for paper foil label	VMPA1-ST-1-4	533 362	
	Inscription label holder for connection block, 4-fold, for IBS 6x10	VMPA1 ST 2-4	544 384	
	H-rail to EN 60715	NRH-35-2000	35 430	
	H-rail mounting	CPA-BG-NRH	173 498	
	Mounting bracket	VMPA-BG-RW	534 416	
User's manual				
	MPA Pneumatics Description	German	P.BE-MPA-DE	534 240
		English	P.BE-MPA-EN	534 241
		French	P.BE-MPA-FR	534 243
		Italian	P.BE-MPA-IT	534 244
		Spanish	P.BE-MPA-ES	534 242
		Swedish	P.BE-MPA-SV	534 245

AS-interface® components

VTSA/VTSA-F valve terminal – Overview

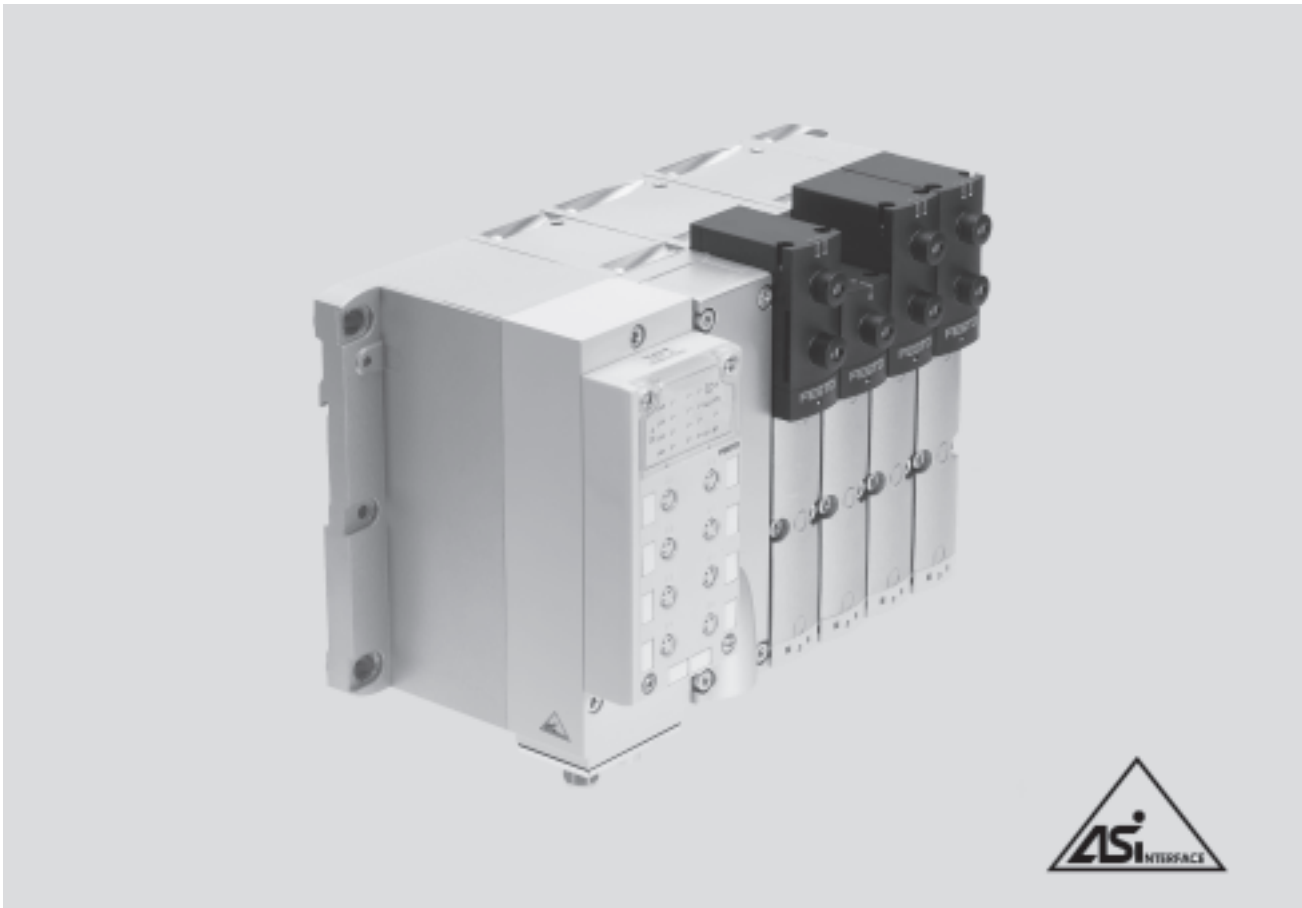

VTSA/VTSA-F valve terminals with AS-interface – Valve configuration options

VTSA/VTSA-F valve terminals with AS-interface can be flexibly configured with a wide range of valves. The system supports a maximum of 8 outputs (solenoid coils) and 8 inputs per valve terminal. This gives the following basic valve configuration options (see tables on following page).

General data

- Solutions with integrated inputs
- Width 18, 26 (VTSA and VTSA-F) or 42 mm (VTSA only)
- With or without 24 V DC auxiliary power supply for solenoid coils (EMERGENCY-STOP circuitry) in the case of the 4I/40 version. The auxiliary power supply is always integrated in the version with 8 inputs and cannot be subsequently switched off using the DIL switch
- Selectable bus connection technology
 - Flat cable for AS-interface with 4I/40 version
 - 4-pin M12 round plug¹⁾ with 4I/40 and 8I/80 version
- Selectable addressing
 - Via bus connection (M12 or flat cable)

Versions

- 1 to 8 valves, freely configurable
- With 4 or 8 inputs
- M12, M8, quick connection, tension spring or Sub-D connection technology
- Separating seals for the creation of pressure zones
- Suitable for vacuum
- Subsequent extensions either
 - via vacant positions
 - by converting the valve terminal

Application

- Flexible and cost-effective connection of 1 or 8 valves (max. 8 solenoid coils) with input feedback
- Decentralised machine and system structures, for example
 - in handling technology
 - in conveyor technology
 - in the packaging industry
 - in sorting systems
 - suitable for energy chains thanks to connection via round cables

Note

Please follow the link below for more details on the various pneumatic functions.

➔ Internet: vtsa

1) Suitable cable distributor from flat cable to M12: ASI-KVT-FKx2-M12

AS-interface® components

VTSA/VTSA-F valve terminal – Connection technology and addressing

Types of valve terminal with AS-interface								
Type	Valves	Solenoid coils	Inputs	Auxiliary power supply can be disconnected		Width		
				Yes	No	18 mm	26 mm	42 mm ¹⁾
VTSA/VTSA-F-ASI-4E4A-Z	4	4	4	■	–	■	■	■
VTSA/VTSA-F-ASI-8E8A-Z	8	8	8	–	■	■	■	■

1) Width 42 mm not in the case of VTSA-F

Permissible combinations in valve position allocation (examples)				
Type	Slave n			
	0	1	2	3
4l/40 VTSA/VTSA-F - 18 and 26 mm (2 valves per sub-base)	M	M	M	M
	M	M	M	L
	M	M	–	–
	M	L	–	–

	J	M	–	–
	M	J	–	–
	J	J	–	–
Special case	M	M	J	L
4l/40 VTSA – 42 mm (1 valve per sub-base)	M	M	M	M
	M	M	M	L
	M	M	–	–
	M	–	–	–

	J	M	–	–
	J	M	M	–

	M	J	M	–
	J	J	–	–

Permissible combinations in valve position allocation (examples)								
Type	Slave n plus slave n+1							
	0	1	2	3	4	5	6	7
8E8A VTSA/VTSA-F	M	M	M	M	M	M	M	M
	M	M	M	L	M	M	M	L

	J	J	J	J	–	–	–	–
	J	J	J	M	–	–	–	–
	J	J	M	M	–	–	–	–

	J	J	M	M	M	M	–	–

- 1) - All valve slices can be freely configured (up to the maximum number of valve solenoids supported (4 or 8)).
 - A blanking plate can be used instead of the valve slice as a vacant position for one or two solenoid coils.
- M Valve slice with single solenoid valve or a different valve slice with an output.
 J Valve slice with double solenoid valve or a different valve slice with two outputs.
 L Vacant position

AS-interface[®] components

VTSA/VTSA-F valve terminal – Connection technology and addressing

Installation: Selectable connection technology for AS-interface

Support for flat cables

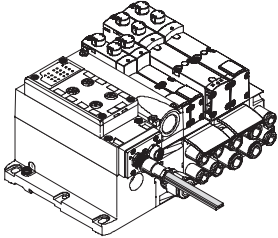

- Straightforward cabling with flat cables in protected areas
- Fast system of installation with standard AS-interface cables
- Standard installation at the AS-interface with yellow flat cables is possible with the 4I/4O VTSA/VTSA-F version

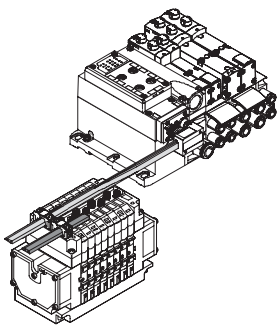

Support for round cables

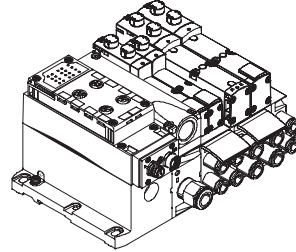

Local round cable wiring system for areas subjected to consistently high stress:

- Permanently high humidity
- Need for flexible cabling using one cable
- Use in energy chains with highly flexible cables

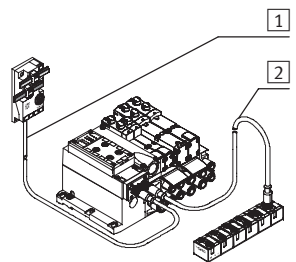

- 1 Pre-assembled M12 round cable, 1 m, polyurethane
- 2 Selectable cable for additional slave, for example highly flexible cable for energy chains or PVC cable for applications requiring resistance to detergents

Addressing

Addressing device

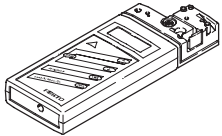

- The addressing device to SPEC V2.1 can be used to scan the AS-interface from any point in the network. At all connected stations
- slave addresses can be read/changed
 - ID and IO codes can be read out
 - parameters can be read/changed
 - input/output data can be read and written (setting outputs)
 - error messages can be read out and quickly recognised

AS-interface connections

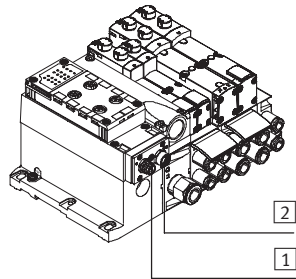

- 1 M12 plug for AS-interface and incoming auxiliary supply
- 2 M12 socket for AS-interface and outgoing auxiliary supply

AS-interface® components

VTSA/VTSA-F valve terminal – Connection technology and addressing

AS-interface flat cable distributor to round cable 2x M12

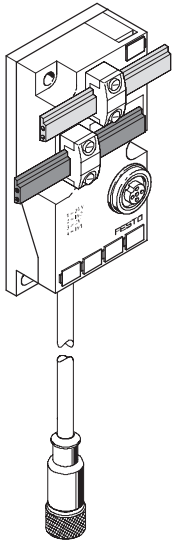

Alternative connection concepts

- AS-interface connection technology for yellow and optionally for black flat cables
- Passive conversion of the signals to M12 socket and round cable via M12 socket
- Pre-assembled round cable, PUR, 1 m long
- Selectable PVC extension cable, 2.5 and 5 m, via additional M12 socket

Selecting the cable

Optimised connection technologies at the AS-interface can be easily realised by selecting the right cable.

- Flat cables for all standard applications with installation-saving insulation displacement technology
- Round cables for applications with differing requirements, for example:
 - Energy chains with small radii and further requirements for highly flexible cables
 - Applications with consistently high humidity

- Applications involving frequent cleaning and requiring cables resistant to detergents (PUR, PVC or other cables)
- Cabling systems using standard components (M12) preferred

Easy to mount

- Direct mounting on a wall or machine frame
- Direct mounting on the 40 mm ITEM profile
- Mounting on H-rail using adapter CP-TS-HS35

Supplementary compact I/O modules

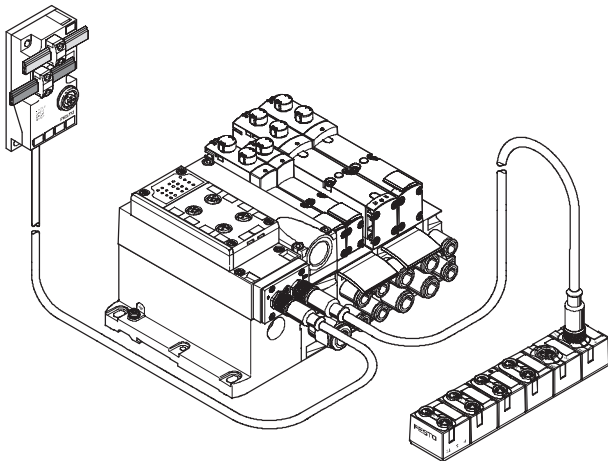

The valve terminals VTSA/VTSA-F can be supplemented with the compact I/O modules. The following are available:

- 8 inputs M8
- 4 inputs/3 outputs M12
- 4 inputs/2 valve plugs

AS-interface® components

Key features – Display and operation

Display and operation

Each solenoid coil is allocated an LED which indicates its switching status.

- Indicator 12 shows the switching status of the pilot control for output 2
- Indicator 14 shows the switching status of the pilot control for output 4

Manual override

The manual override enables the valve to be actuated when not electrically activated or energised.

The valve is activated by pushing the manual override. The set switching status can also be locked by turning the manual override.

Alternatives:

- A cover (code N or as accessory) can be fitted over the manual override to prevent it from being locked. The valve can only be actuated by pressing it.

- A cover (code V) can be fitted over the manual override to prevent it from being accidentally activated.

Pneumatic connection and control elements

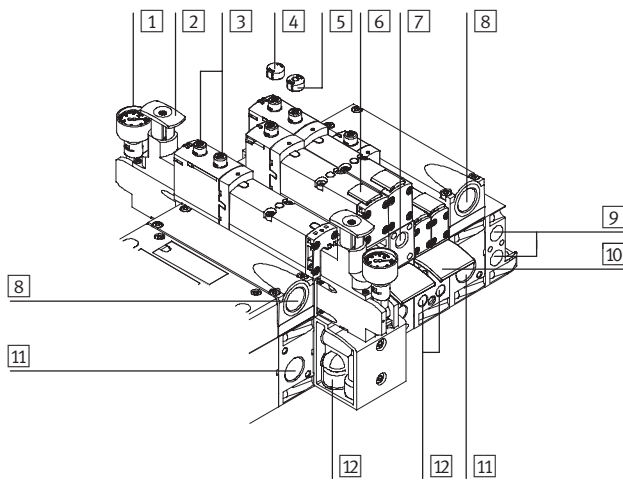

- | | |
|--|---|
| <ul style="list-style-type: none"> 1 Pressure gauge (optional) 2 Adjusting knob for optional pressure regulator plate 3 Manual override (for each pilot solenoid coil, non-detenting or detenting) 4 Optional cover for manual override (prevents manual override) 5 Optional cover for manual override with non-detenting/pushing function 6 Inscription label holder for valve 7 Adjusting screw of optional flow control plate 8 Exhaust ports (valves) (3/5) | <ul style="list-style-type: none"> 9 Pilot ports 12 and 14 for supplying the external pilot air supply 10 Inscription label holder for sub-base 11 Supply port 1 (operating pressure) 12 Working ports 2 and 4, for each valve position |
|--|---|



Note

A manually actuated valve (manual override) cannot be reset electrically. Conversely, an electrically actuated valve cannot be reset using the mechanical manual override.

Electrical connection and display components

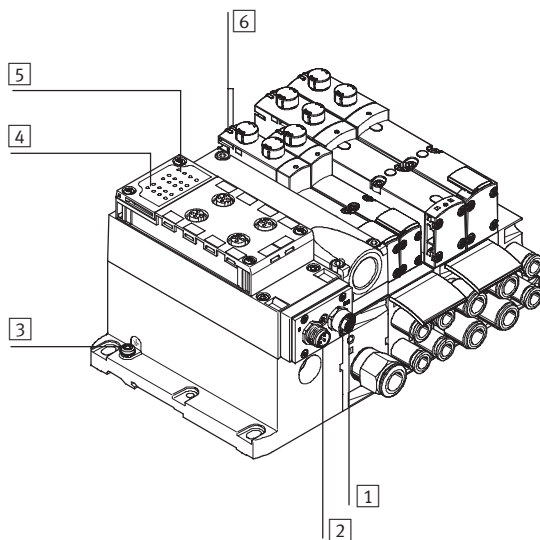

- 1 M12 socket AS-interface bus and additional supply (AS-i Out)
- 2 M12 plug AS-interface bus and additional supply (AS-i In)
- 3 Earth terminal
- 4 Status LEDs inputs
- 5 Status LEDs AS-interface
- 6 Diagnostic LEDs valves

AS-interface® components

VTSA/VTSA-F valve terminal

Technical data				
Type	VTSA/VTSA-F-ASI-4E4A-Z		VTSA/VTSA-F-ASI-8E8A-Z	
Part No.	Order via order code/valve terminal configurator			
Valves	Number of solenoid coils	4		8
	Valve width [mm]	18/26/42 (width 42 mm only in the case of VTSA)		
	External power supply 24 V DC	Set using DIL switch		Yes
Inputs	No. of digital inputs	4		8
	Connection technology	5-pin M12, 3-pin M8, quick connection, tension spring, Sub-D		
	Sensor supply via AS-interface	Short circuit and overload proof		
	Sensor connection	2-wire and 3-wire sensors		
	Type	IEC 1131-2, type 02		
	Input circuitry	PNP (positive switching)		
AS-interface connection	Connection technology	M12 connection ²⁾		
	Voltage range [V DC]	26.5 ... 31.6, reverse polarity protected		
	Residual ripple [mVss]	20		
	Current consumption of inputs	Without auxiliary power supply	With auxiliary power supply	With auxiliary power supply
	Basic electronic load	≤25	≤25	≤25
Total input current	350	350	350	
AS-interface connection	Total current consumption	Max. 500	Max. 700	Max. 700
Load voltage connection	Connection technology	M12 connection ²⁾		
	Voltage range [V DC]	21.6 ... 26.4		
	Residual ripple [Vss]	4		
Max. current consumption of valves per solenoid coil	[mA]	90		
LED displays	ASI-LED	Green		
	AUX-PWR-LED	Green		
	FAULT-LED	Red		
	Inputs	Green		
	Valves	Yellow		
General data	Protection class (to EN 60529)	IP65, NEMA 4 (in assembled state)		
	Electromagnetic compatibility	Tested to 50295 (low voltage switchgear)		
	CE mark	Yes, in accordance with EU Directive 89/336/EEC		
	Temperature range [°C]	Operation: -5 ... +50; storage/transport: -20 ... +40		
	Materials	Manifold sub-base, right-hand end plate: die-cast aluminium; left-hand end plate: die-cast aluminium, polyamide		
	Dimensions	➔ Internet: type 44		
	Weight [g]	AS-interface: 360 (silencer), 369 (exhaust plate)		
AS-interface data	ID code	ID = F _H ; ID1 = F _H ¹⁾ ; ID2 = E _H		
	IO code	7 _H		
	Profile	S-7.FE		

 1) Factory setting, set to 0_H by some programming devices (Spec. V2.1) when addressing the slave

2) Suitable cable distributor from flat cable to M12 ➔ 136

Pin allocation as for NEBU-M12G5-F-0,2-M12G4 ➔ 56

AS-interface® components

VTSA/VTSA-F valve terminal – Connection blocks



Combinations of connection blocks and electronics modules for inputs

Connection blocks	Part No.	VTSA/VTSA-F-ASI-8E8A-Z	VTSA/VTSA-F-ASI-4E4A-Z
CPX-AB-4-M12x2-5POL	195 704	■	■
CPX-AB-4-M12x2-5POL-R	541 254	■	■
CPX-AB-8-KL-4POL	195 708	■	■
CPX-AB-1-Sub-BU-25POL	525 676	■	■
CPX-AB-4-HAR-4POL	525 636	■	■
CPX-AB-8-M8-3POL	195 706	■	■

Pin allocation

Connection block inputs		VTSA/VTSA-F-ASI-8E8A-Z	VTSA/VTSA-F-ASI-4E4A-Z
CPX-AB-4-M12X2-5POL			
	<p>X1 X3</p>	<p>X1.1: 24 V_{SEN} X1.2: Input x+1 X1.3: 0 V_{SEN} X1.4: Input x X1.5: FE (earth)</p>	<p>X3.1: 24 V_{SEN} X3.2: Input x+5 X3.3: 0 V_{SEN} X3.4: Input x+4 X3.5: FE (earth)</p>
	<p>X2 X4</p>	<p>X2.1: 24 V_{SEN} X2.2: Input x+3 X2.3: 0 V_{SEN} X2.4: Input x+2 X2.5: FE (earth)</p>	<p>X4.1: 24 V_{SEN} X4.2: Input x+7 X4.3: 0 V_{SEN} X4.4: Input x+6 X4.5: FE (earth)</p>
CPX-AB-8-M8-3POL			
	<p>X1 X2 X3 X4</p>	<p>X1.1: 24 V_{SEN} X1.3: 0 V_{SEN} X1.4: Input x</p>	<p>X5.1: 24 V_{SEN} X5.3: 0 V_{SEN} X5.4: Input x+4</p>
	<p>X5 X6 X7 X8</p>	<p>X2.1: 24 V_{SEN} X2.3: 0 V_{SEN} X2.4: Input x+1</p> <p>X3.1: 24 V_{SEN} X3.3: 0 V_{SEN} X3.4: Input x+2</p> <p>X4.1: 24 V_{SEN} X4.3: 0 V_{SEN} X4.4: Input x+3</p>	<p>X6.1: 24 V_{SEN} X6.3: 0 V_{SEN} X6.4: Input x+5</p> <p>X7.1: 24 V_{SEN} X7.3: 0 V_{SEN} X7.4: Input x+6</p> <p>X8.1: 24 V_{SEN} X8.3: 0 V_{SEN} X8.4: Input x+7</p>

Pin allocation					
Connection block inputs		VTSA/VTSA-F-ASI-8E8A-Z		VTSA/VTSA-F-ASI-4E4A-Z	
CPX-AB-8-KL-4POL					
		X1.0: 24 V _{SEN} X1.1: 0 V _{SEN} X1.2: Input x X1.3: FE (earth)	X5.0: 24 V _{SEN} X5.1: 0 V _{SEN} X5.2: Input x+4 X5.3: FE (earth)	X1.0: 24 V _{SEN} X1.1: 0 V _{SEN} X1.2: Input x X1.3: FE (earth)	X5.0: 24 V _{SEN} X5.1: 0 V _{SEN} X5.2: Input x+2 X5.3: FE (earth)
		X2.0: 24 V _{SEN} X2.1: 0 V _{SEN} X2.2: Input x+1 X2.3: FE (earth)	X6.0: 24 V _{SEN} X6.1: 0 V _{SEN} X6.2: Input x+5 X6.3: FE (earth)	X2.0: 24 V _{SEN} X2.1: 0 V _{SEN} X2.2: Input x+1 X2.3: FE (earth)	X6.0: 24 V _{SEN} X6.1: 0 V _{SEN} X6.2: Input x+3 X6.3: FE (earth)
		X3.0: 24 V _{SEN} X3.1: 0 V _{SEN} X3.2: Input x+2 X3.3: FE (earth)	X7.0: 24 V _{SEN} X7.1: 0 V _{SEN} X7.2: Input x+6 X7.3: FE (earth)	X3.0: 24 V _{SEN} X3.1: 0 V _{SEN} X3.2: Input x+1 X3.3: FE (earth)	X7.0: 24 V _{SEN} X7.1: 0 V _{SEN} X7.2: Input x+3 X7.3: FE (earth)
		X4.0: 24 V _{SEN} X4.1: 0 V _{SEN} X4.2: Input x+3 X4.3: FE (earth)	X8.0: 24 V _{SEN} X8.1: 0 V _{SEN} X8.2: Input x+7 X8.3: FE (earth)	X4.0: 24 V _{SEN} X4.1: 0 V _{SEN} X4.2: n.c. X4.3: FE (earth)	X8.0: 24 V _{SEN} X8.1: 0 V _{SEN} X8.2: n.c. X8.3: FE (earth)
CPX-AB-1-SUB-BU-25POL					
		1: Input x 2: Input x+1 3: Input x+2 4: Input x+3 5: 24 V _{SEN} 6: 0 V _{SEN} 7: 24 V _{SEN} 8: 0 V _{SEN} 9: 24 V _{SEN} 10: 24 V _{SEN} 11: 0 V _{SEN} 12: 0 V _{SEN} 13: FE (earth)	14: Input x+4 15: Input x+5 16: Input x+6 17: Input x+7 18: 24 V _{SEN} 19: 24 V _{SEN} 20: 24 V _{SEN} 21: 24 V _{SEN} 22: 0 V _{SEN} 23: 0 V _{SEN} 24: 0 V _{SEN} 25: FE (earth) Socket: FE	1: Input x 2: Input x+1 3: Input x+1 4: n.c. 5: 24 V _{SEN} 6: 0 V _{SEN} 7: 24 V _{SEN} 8: 0 V _{SEN} 9: 24 V _{SEN} 10: 24 V _{SEN} 11: 0 V _{SEN} 12: 0 V _{SEN} 13: FE (earth)	14: Input x+2 15: Input x+3 16: Input x+3 17: n.c. 18: 24 V _{SEN} 19: 24 V _{SEN} 20: 24 V _{SEN} 21: 24 V _{SEN} 22: 0 V _{SEN} 23: 0 V _{SEN} 24: 0 V _{SEN} 25: FE (earth) Socket: FE
CPX-AB-4-HAR-4POL					
		X1.1: 24 V _{SEN} X1.2: Input x+1 X1.3: 0 V _{SEN} X1.4: Input x	X3.1: 24 V _{SEN} X3.2: Input x+5 X3.3: 0 V _{SEN} X3.4: Input x+4	X1.1: 24 V _{SEN} X1.2: Input x+1 X1.3: 0 V _{SEN} X1.4: Input x	X3.1: 24 V _{SEN} X3.2: Input x+3 X3.3: 0 V _{SEN} X3.4: Input x+2
		X2.1: 24 V _{SEN} X2.2: Input x+3 X2.3: 0 V _{SEN} X2.4: Input x+2	X4.1: 24 V _{SEN} X4.2: Input x+7 X4.3: 0 V _{SEN} X4.4: Input x+6	X2.1: 24 V _{SEN} X2.2: n.c. X2.3: 0 V _{SEN} X2.4: Input x+1	X4.1: 24 V _{SEN} X4.2: n.c. X4.3: 0 V _{SEN} X4.4: Input x+3

Dimensions

Download CAD data → www.festo.com

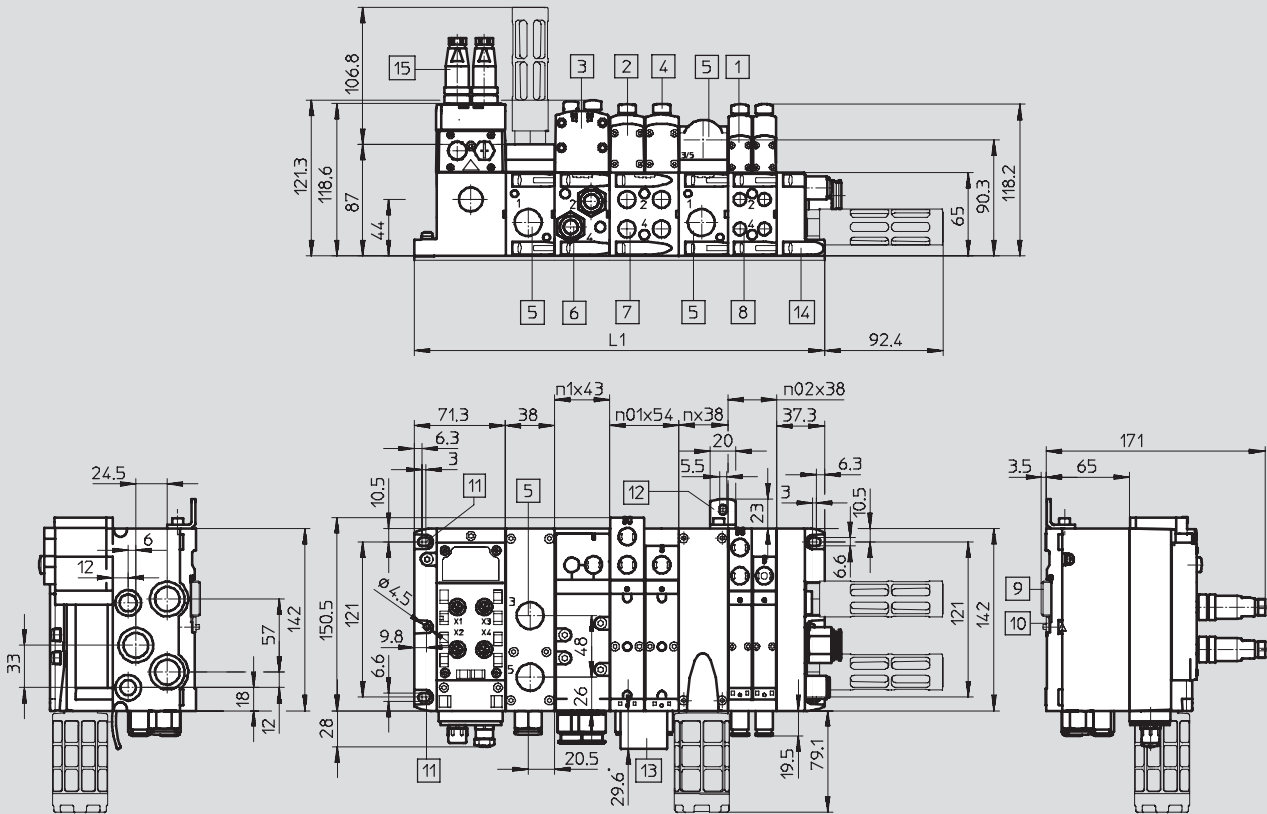

- | | | | |
|--|--|--------------------------------|---|
| 1 Solenoid valve 18 mm | 7 Threaded connection G $\frac{1}{4}$ or $\frac{1}{4}$ NPT | 12 Additional mounting bracket | n02 Number of manifold blocks 18 mm |
| 2 Solenoid valve 26 mm | 8 Threaded connection G $\frac{3}{8}$ or $\frac{1}{8}$ NPT | 13 Inscription label | n01 Number of manifold blocks 26 mm |
| 3 Solenoid valve 42 mm (not in the case of VTSA-F) | 9 H-rail | 14 End plate | n1 Number of manifold blocks 42 mm |
| 4 Cover cap/manual override | 10 H-rail mounting | 15 Plug M12 | n Number of supply plates (only with end plate with selector plate) |
| 5 Threaded connection G $\frac{1}{2}$ or $\frac{1}{2}$ NPT | 11 Mounting hole | | |
| 6 Threaded connection G $\frac{3}{8}$ or $\frac{3}{8}$ NPT | | | |

Width	L1
18 mm	$71.3 + n02 \times 38 + n \times 38 + 37.3$
26 mm	$71.3 + n01 \times 54 + n \times 38 + 37.3$
42 mm (not in the case of VTSA-F)	$71.3 + n1 \times 43 + n \times 38 + 37.3$
Mixture of 18 mm, 26 mm and 42 mm	$71.3 + n02 \times 38 + n01 \times 54 + n1 \times 43 + n \times 38 + 37.3$

AS-interface® components

VTSA/VTSA-F valve terminal – Accessories











FESTO

Ordering data				
	Description		Type	Part No.
Bus connection				
	AS-interface flat cable, yellow	100 m	KASI-1,5-Y-100	18 940
	AS-interface flat cable, black	100 m	KASI-1,5-Z-100	18 941
	Flat cable blanking plug		ASI-SD-FK-BL	196 090
	AS-interface flat cable distributor	Parallel cable	ASI-KVT-FK	18 786
	AS-interface flat cable distributor	Symmetrical cable	ASI-KVT-FK-S	18 797
	Cable distributor (yellow and black)	Via 2x M12, 4-pin	ASI-KVT-FKx2-M12	527 474
	Cable cap for flat cable (scope of delivery 50 pieces)		ASI-KK-FK	18 787
	Cable sleeve (scope of delivery 20 pieces)		ASI-KT-FK	165 593
	M12 socket for flat cable		ASI-SD-FK-M12	18 788
	M12 socket for flat cable	With PG13.5 connector	ASI-SD-PG-M12	18 789
	M12 socket for round cable	With PG9, 5-pin connector	FBSD-GD-9-5POL	18 324
DUO plug				
	Plug M12 for 2 sensor cables	4-pin, PG11	SEA-GS-11-DUO	18 779
		5-pin, PG11	SEA-5GS-11-DUO	192 010
T-type plug connector				
	Plug M12, 2x socket M12 5-pin		NEDU-M12D5-M12T4	541 596
	Plug M8, 3-pin, to M12 4-pin		NEDU-M8D3-M12T4	541 597

AS-interface® components

VTSA/VTSA-F valve terminal – Accessories



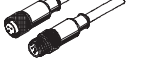
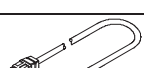
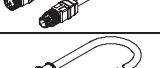



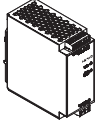
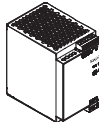
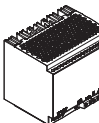

FESTO

Ordering data				
	Description		Type	Part No.
Sensor plugs				
	Straight sensor plug	M12, 4-pin, PG7	SEA-GS-7	18 666
	Straight sensor plug	M12, 5-pin, PG7	SEA-M12-5GS-PG7	175 487
	Straight sensor plug	M12, PG9 connector	SEA-GS-9	18 778
	Straight sensor plug for cable Ø 2.5 mm	M12, 4-pin	SEA-4GS-7-2,5	192 008
	Straight sensor plug	M8, screw-in, 3-pin	SEA-3GS-M8-S	192 009
	Straight sensor plug	M8, solderable, 3-pin	SEA-GS-M8	18 696
	Harax sensor plug	4-pin	SEA-GS-HAR-4POL	525 928
	Sub-D plug	25-pin	SD-SUB-D-ST25	527 522
	Protective cap	M12	ISK-M12	165 592
		M8	ISK-M8	177 672
Connecting cable				
	Modular system for connecting cables → Internet: nebu		NEBU-...	–
	Connecting cable, straight plug, straight socket	M8, 0.5 m	KM8-M8-GSGD-0,5	175 488
		M8, 1.0 m	KM8-M8-GSGD-1	175 489
		M8, 2.5 m	KM8-M8-GSGD-2,5	165 610
		M8, 5.0 m	KM8-M8-GSGD-5	165 611
	Connecting cable, straight plug, straight socket	M12, 4-pin/5-pin, 0.2 m	NEBU-M12G5-F-0.2-M12G4	542 129
		M12, 4-pin, 2.5 m	KM12-M12-GSGD-2,5	18 684
		M12, 4-pin, 5.0 m	KM12-M12-GSGD-5	18 686
	Connecting cable, straight plug, angled socket	M12, 4-pin, 1.0 m	KM12 M12-GSWD-1-4	185 499
	DUO cable M12 4-pin via 2xM8, 3-pin	2x straight socket	KM12-DUO-M8-GDGD	18 685
		2x straight/angled socket	KM12-DUO-M8-GDWD	18 688
		2x angled socket	KM12-DUO-M8-WDWD	18 687

AS-interface® components

VTSA/VTSA-F valve terminal – Accessories

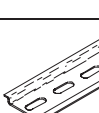
FESTO

Ordering data				
	Description	Type	Part No.	
Miscellaneous				
	Primary switched mode modular power supply AS-i power supply 4.8 A	SVG-1/230VAC-ASI-5A	547 869	
	Primary switched mode modular power supply 24 VDC power supply 5 A	SVG-1/230-24VDC-5A	547 867	
	Primary switched mode modular power supply 24 VDC power supply 10 A	SVG-1/230-24VDC-10A	547 868	
	Addressing device (power supply plug included in scope of delivery)	ASI-PRG-ADR	18 959	
	Addressing cable	KASI-ADR	18 960	
	AS-interface input module for 8 inputs M8	ASI-8DI-M8-3POL	542 124	
	AS-interface input/output module for 4 inputs/3 outputs M12	ASI-4DI3DO-M12X2-5POL-Z	542 125	
	Clip-on inscription label holder for valve cap (pack of 5)	ASCF-T-S6	540 888	
	Inscription label holder for connection blocks (pack of 5)	ASCF-M-S6	540 889	
	H-rail to EN 60715	NRH-35-2000	35 430	
	H-rail mounting	CPA-BG-NRH	173 498	
User's manual				
	Description of the valve terminal VTSA/VTSA-F	German	P.BE-VTSA-44-DE	538 922
		English	P.BE-VTSA-44-EN	538 923
		French	P.BE-VTSA-44-FR	538 925
		Italian	P.BE-VTSA-44-IT	538 926
		Spanish	P.BE-VTSA-44-ES	538 924
		Swedish	P.BE-VTSA-44-SV	538 927

AS-interface® components

Compact I/O modules and valve interfaces to Spec. V2.1

FESTO

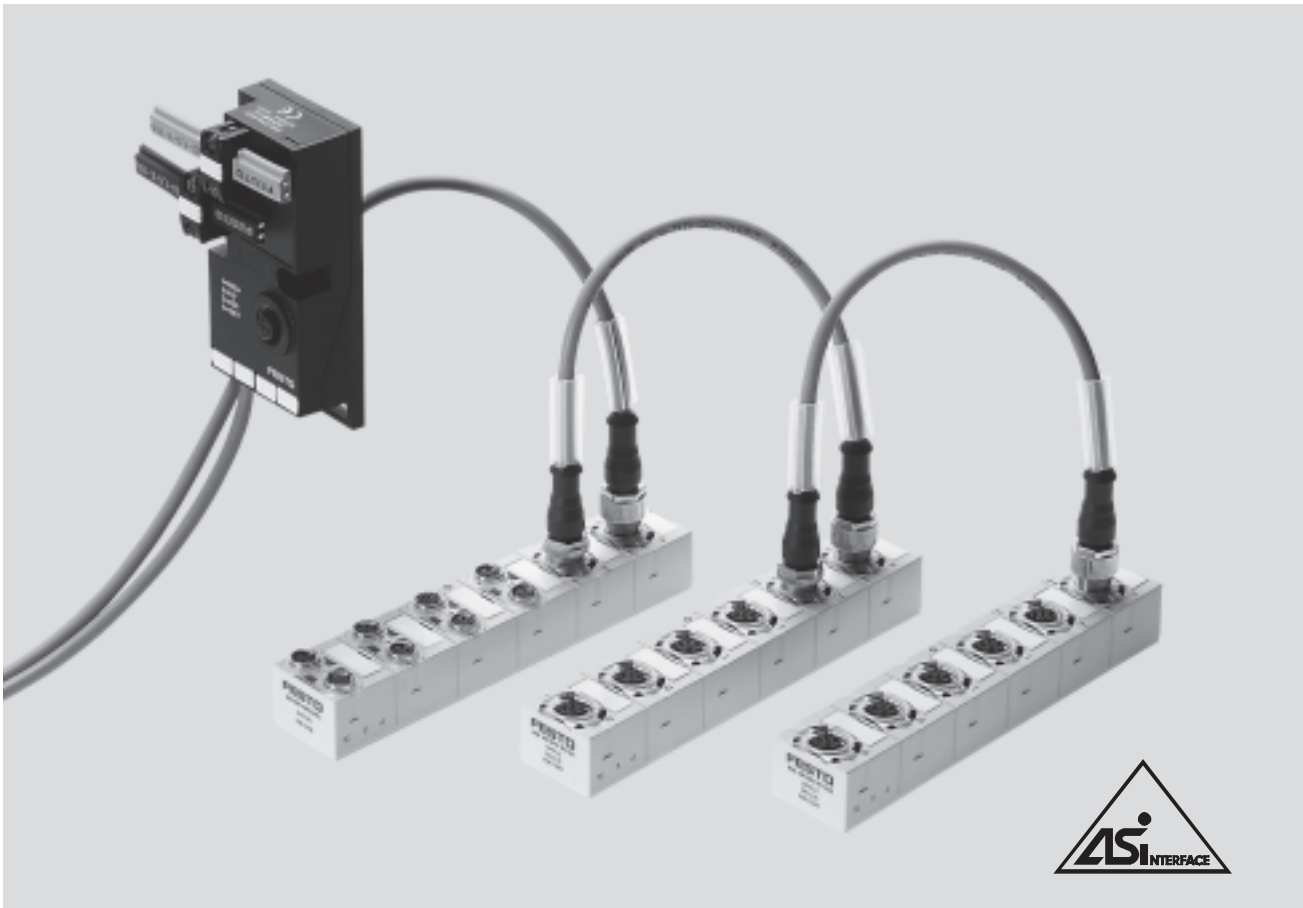

Compact I/O modules to Spec. V2.1

General description

- Highly compact modules
- Encapsulated, sturdy electronics
- Inputs/outputs to IEC1131, PNP
- Short circuit proof, overload proof
- Inputs suitable for proximity sensors, inductive, capacitive or optical sensors and light barriers
- Ideal for use in decentralised handling and assembly as well as universal applications with increased requirements
- AS-interface Specification V2.11
- A/B mode
- Bus and auxiliary power supply looped through via 2x M12
- Quick installation
- Individual module diagnostics

Module with 8 inputs

- Two slaves in one housing
- 8 inputs M8, 3-pin, 200 mA per input
- Peripherals faults per slave, two fault LEDs
- Status display per input
- Supply exclusively from "yellow" AS-interface cable, the pins for the auxiliary power supply are simply looped through
- This permits cascading of the input/output modules

Module with 4 inputs/3 outputs

- Individual slave
- 4 inputs M12, 5-pin, with double allocation, 200 mA per input
- 3 outputs M12, 5-pin, with double allocation, 1 A per output
- Peripherals fault, fault LED
- Status display for each input and output
- Inputs are supplied exclusively from the "yellow" AS-interface cable
- Outputs are supplied exclusively from the "black" AS-interface cable

Module with 4 inputs/2 valve plugs

- Individual slave
- 4 inputs M12, 5-pin, with double allocation, 200 mA per input
- 2 outputs with pre-assembled plug socket with 0.5 m cable for valves, 1 A per output
- Festo plug and work™ for the following valves:
 - Tiger2000, Tiger Classic
 - CPE18/24, MIDI
 - CPE10/14
 - ISO, VDMA and Namur
 - VB series
 - Electrical on-off valves

AS-interface® components

Compact I/O modules and valve interfaces

Applications

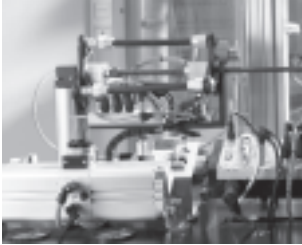

The M12 bus connection standardised in the AS-interface specification offers various advantages:

- Use of standardised, pre-assembled M12 connecting cables
- One cable instead of two
- Installation-saving, quick M12 screw-type lock
- Flexible selection and optimisation of the necessary cable qualities in areas with permanently high stress, for example for

- energy chains
- robot arms (torsion)
- environments with higher moisture content
- aggressive media

This connection technology makes compact modules ideal for use both in demanding and extremely tight conditions.

Decentralised machine and system structures, for example

- Handling technology
- Conveyor technology
- Packaging industry
- Sorting systems
- Upstream functions via energy chains and robot arms

Tips on use

- In addition to valve terminals for optimising the number of inputs.

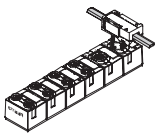

- Suitable for valve terminals with M12 bus connection for looping through the bus via M12

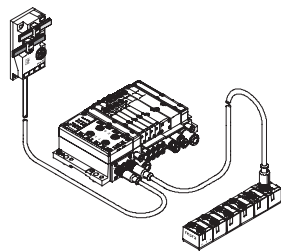

- Universal applications for all commonly used sensors and light barriers up to 200 mA per channel

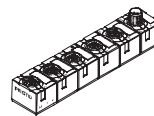

- Universal outputs 1 A, up to 2 A (approx. 50 W) can be connected by means of parallel connection in the DUO plug

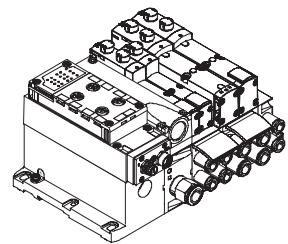

AS-interface flat cable distributor to round cable 2x M12

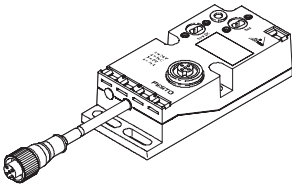

Alternative connection concepts

- AS-interface connection technology for yellow and optionally for black flat cables
- Passive conversion of the signals to M12 socket and round cable via M12 socket
- Pre-assembled round cable, PUR, 1 m long
- Alternatively PVC extension cable, or another suitable cable of any length, via additional M12 socket

Selecting the cable

Optimised connection technologies at the AS-interface can be easily achieved by selecting the right cable.

- Flat cables for all standard applications with installation-saving insulation displacement technology
- Round cables for applications with differing requirements, for example:
 - Energy chains with small radii and further requirements for highly flexible cables
 - Applications with consistently high humidity

- Applications involving frequent cleaning and requiring cables resistant to detergents (PUR, PVC or other cables)
- Cabling systems using standard components (M12) preferred

Easy to fit

- Direct mounting on a wall or machine frame
- Direct mounting on the 40 mm ITEM profile
- Mounting on H-rail using adapter CP-TS-HS35

Tips on use and installation (inputs/outputs)

Input module 8DI-M8

Connection technologies based on M8 take account of the increasing trend towards miniaturisation. Sensors with

pre-assembled M8 connecting cables or with M8 plugs can be directly connected in a 1:1 relationship. This

simplifies allocation and troubleshooting. Individual sensors or cables

can be easily and quickly replaced in the event of faults.

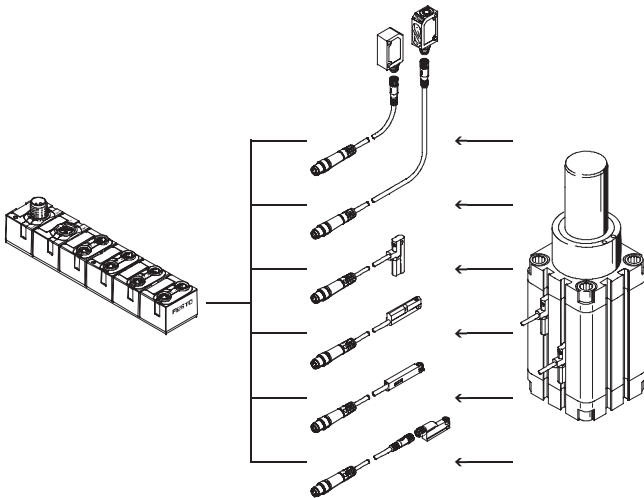

AS-interface® components

Compact I/O modules and valve interfaces

Tips on use and installation (inputs/outputs)

Input/output module 4DI3DO-M12

Sturdy M12 connection technology is still an accepted standard for inputs and outputs. Direct connection for sensors with M12 connection. The M12 interfaces with double allocation can be split into 2xM12 or 2xM8 via DUO plugs, DUO cables or T-adapters.

The standard for valves with central plug (EN 60947-5-2 and ISO 20401) defines double allocation for M12 or M8. This means that a double solenoid valve and a single solenoid valve can be directly connected to a

compact AS-interface module using a 1:1 connection. This simplifies allocation and troubleshooting. Individual valves or cables can be easily and quickly replaced in the event of faults.



- Note

M8 4-pin adapter cables can be configured to M12 5-pin in Festo's modular system for connecting cables (NEBU...) so that even compact valve plugs as in MPA can be directly connected via pre-assembled cables.

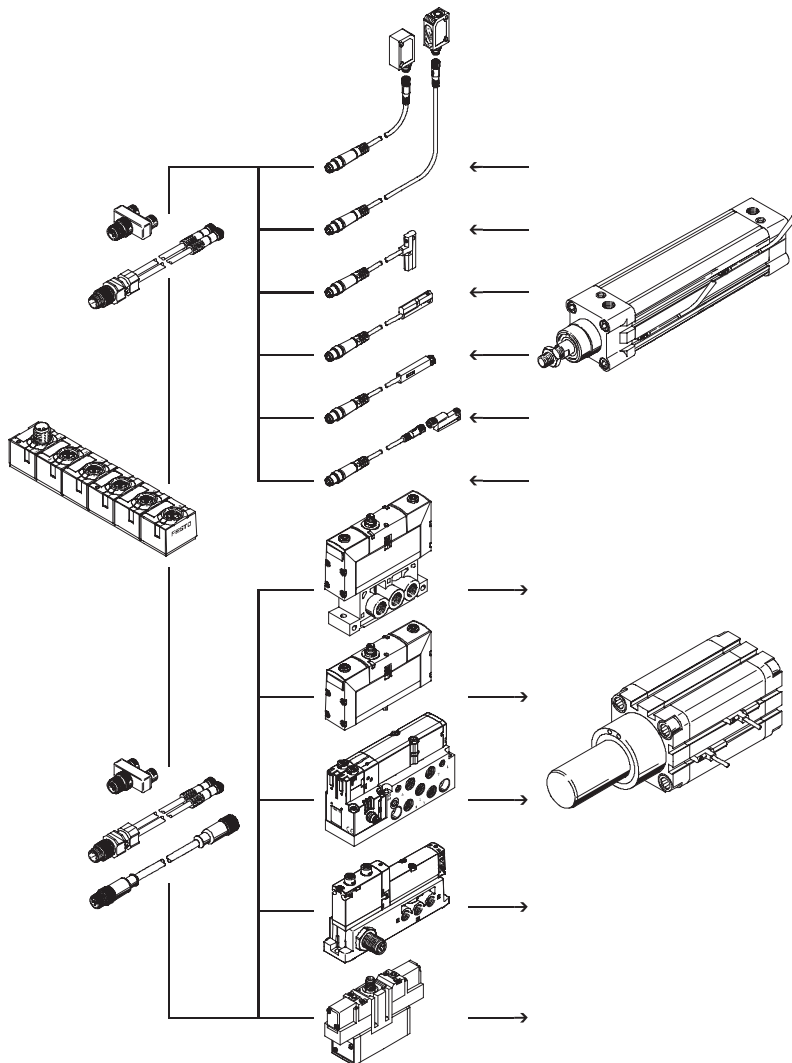

Tips on use and installation (inputs/outputs)

Individual valve interfaces 4DI2DO-M12

These modules with 4 inputs and 2 outputs are ideal for the connection of two single solenoid valves or one

double solenoid valve. If two drives are actuated, 4 sensor signals can be traced. The cables for the solenoid

valve interface are pre-installed and 100% function tested ex-works – ideal for Festo plug and work™.

-  - Note

The electrical outputs correspond to those of the 4DI3DO module, the third output could therefore also be used. Unused valve plugs can be disconnected and the connections sealed with a protective cap.

Version 4DI2DO-2xMF-Z

Suitable for F coils to DIN EN 175301 industrial standard, for example all valves from Festo with the type code

”MFH” such as Tiger2000, Tiger Classic, valves to the ISO and Namur standards as well as on-off valves.

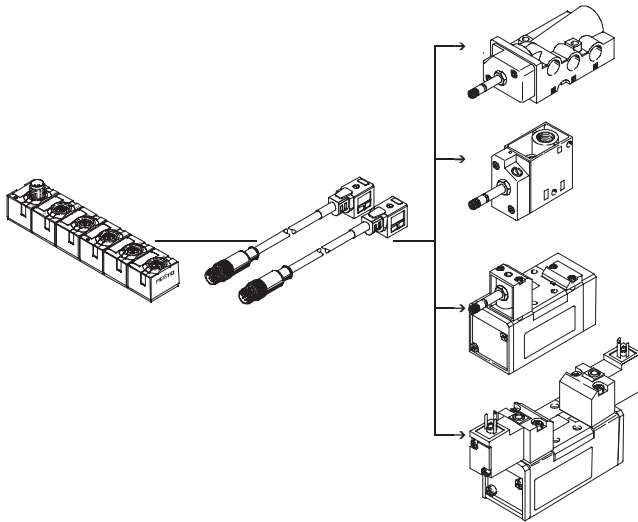

Version 4DI2DO-2xMEB-Z

Suitable for EB coils to DIN EN 175301 type C, for example all valves from Festo with the type code

”MEBH” such as the Midi and VB series, CPE18/24 as well as valves to the ISO and Namur standards.

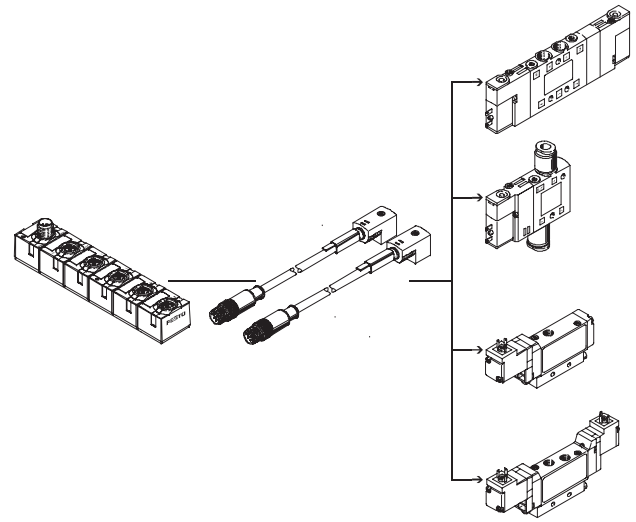

Version 4DI2DO-2xMZB9-Z

Suitable for compact Festo ZC coils with holding current reduction, for example valves CPE10/14-M1BH.

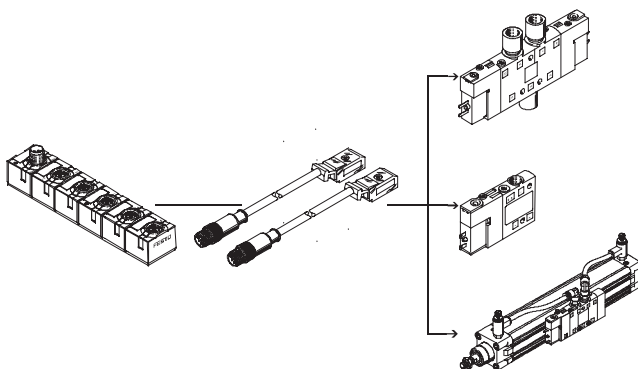

AS-interface® components

Compact I/O modules and valve interfaces

Tips on use and installation (AS-interface)

The compact I/O modules feature 4-pin M12 connections for bus IN and bus OUT. As per the AS-interface

specification, the two signal cables for the bus and the optional 24 V DC auxiliary power supply are accommodated

on this one connection. All 4 connections are looped through so that a number of modules and even

subsequent valve terminals can be cascaded.

Input module 8DI-M8

Supply to the inputs is provided exclusively from the "yellow" AS-interface cable at this module, i.e. the pins for the auxiliary power supply are not used. This means that the following connection technologies can be realised in addition to the connections via M12 round plug connectors:

- Flat cable sockets ASI-SD-FK-M12, directly assembled.
- This permits cost-effective and quick connection of a number of directly adjacent modules.
- A transition to valve terminals such as CPV is possible directly and without converters.

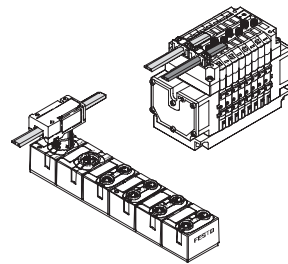

If there is an input module at the end of a string, the flat cable can also be routed through a specially sealed connector.

- Connection socket ASI-SD-PG-M12, directly assembled.
- Use at valve terminals with M12 is also possible, provided the auxiliary power supply is not required.

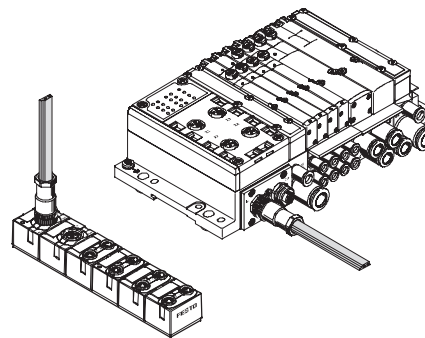

Input/output modules 4DI3DO-M12 and 4DI2DO valves

Supply to the inputs is provided exclusively from the "yellow" AS-interface cable and supply to the outputs is provided exclusively from the "black" AS-interface cable at these modules. Supply is provided either completely by an M12 installation or by means of a suitable converter such as the flat cable distributor ASI-KVT-FKx2-M12.

-  - Note

The contact load capacity of an M12 pin is limited to 4 A. With cascaded modules, ensure that the maximum current load of the first M12 connection in a series will not be exceeded even in a worst case scenario.

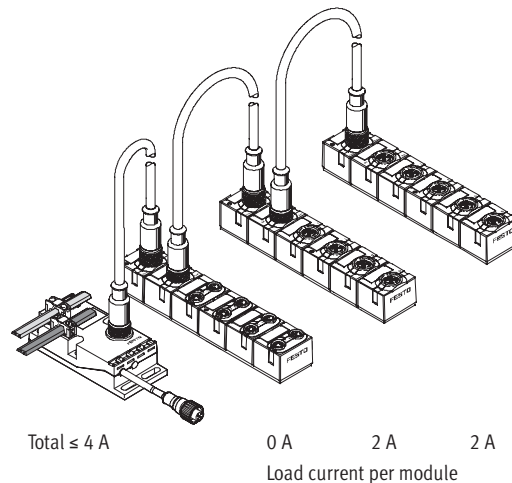

Voltage drop on cables with M12 connection

Note that the voltage drop on an M12 cross sections. The cable lengths must be sized in accordance with the permissible voltage tolerances for the

AS-interface signal and the outputs for consuming devices with additional load voltage. The following graphs provide an initial orientation (non-linear scaling of the cable length):

Voltage drop U (V) for cable cross section 0.34 mm² with M12

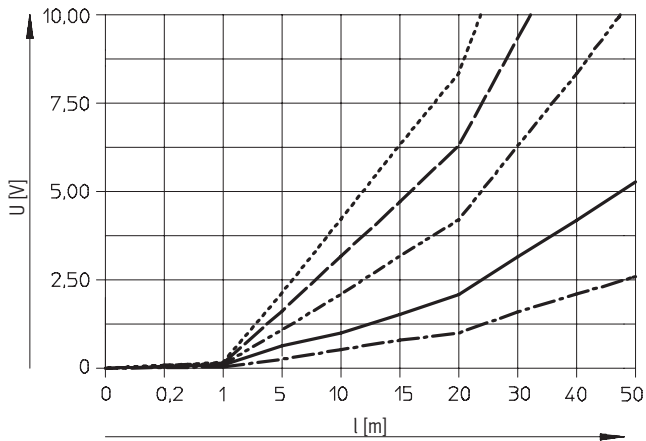

- 0.5 A
- 1 A
- - - - - 2 A
- · — · — 3 A
- 4 A

Voltage drop U (V) for cable cross section 0.25 mm² with M12

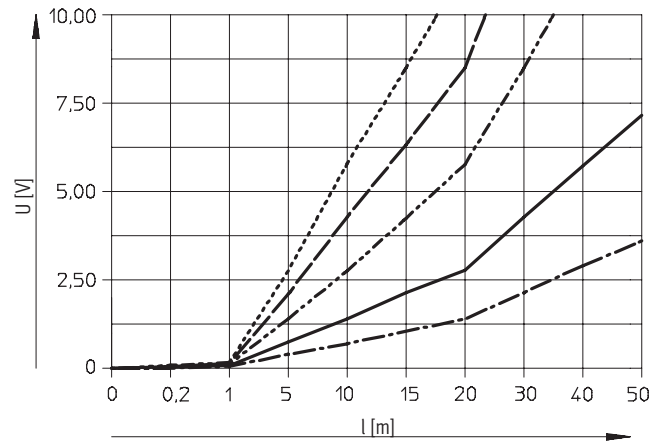

- 0.5 A
- 1 A
- - - - - 2 A
- · — · — 3 A
- 4 A

AS-interface® components

Compact I/O modules and valve interfaces

FESTO

Installation

Installation for consuming devices with high current consumption

If several amperes are to be tapped per module, a suitable supply must be ensured via the corresponding

number of distributors (see the following example). This means that the

max. 3 A per module can be simultaneously switched. Note also that the

voltage drop increases with large currents in the flat cables (2 x 1.5 mm²).

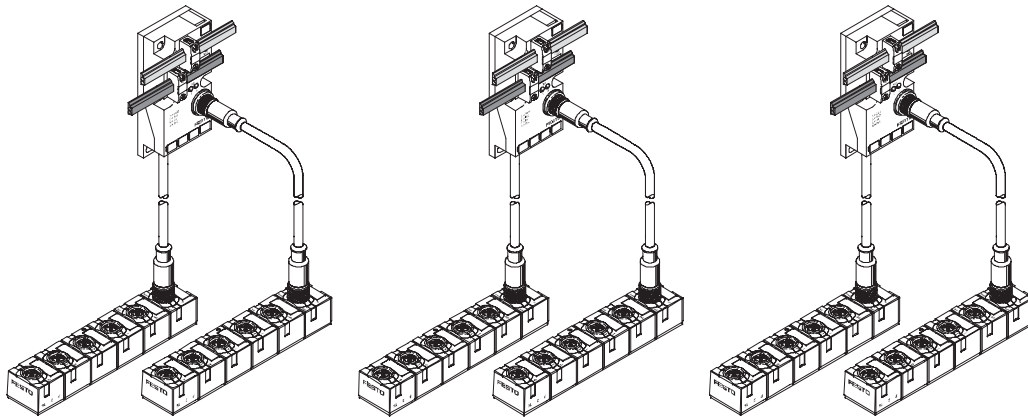

Alternative M12 installation with branch lines

Installation via branch lines can also be selected for straight M12

installation as an alternative to the looped-through AS-i bus.

The T-adapter FB-TA-M12-5POL is ideal for this (bus IN: socket, bus OUT:

plug).

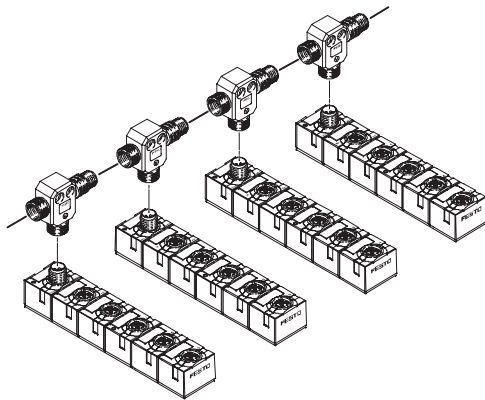

AS-interface® components

Compact I/O modules and valve interfaces

FESTO

Assembly of the compact AS-interface modules

Wall mounting

The AS-interface modules can be mounted on flat surfaces in almost

any position using the existing mounting holes and two M4 screws.

-  - Note

The modules are protected against short circuit using a thermal fuse. This can result in the housing heating up to over 100 °C with short circuits of long duration.

You should therefore install the modules on a base and in an environment designed for this temperature and which is free of fire risk due to ignition (ATEX category T4 – up to 135°).

Wall mounting – Compact I/O modules

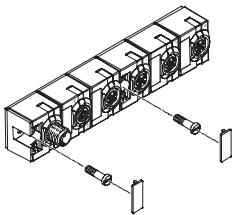

With the compact I/O modules, the mounting holes are covered by inscription labels.

Mounting on profiles (ITEM, etc.)

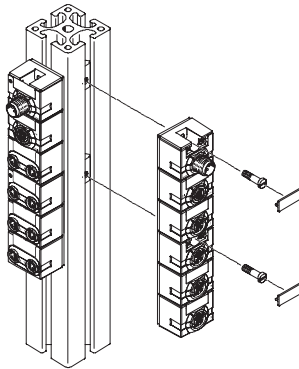

With slot nuts for M4, otherwise see wall mounting.

H-rail mounting

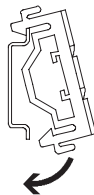
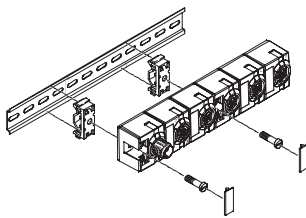

A mounting kit is available that can be used on an H-rail. On the compact CP modules, the mounting holes are covered by inscription labels.

The following mounting kit is required for H-rail mounting:

- CP-TS-HS35
- This enables mounting on H-rails to EN 60715.

AS-interface® components

Compact I/O modules and valve interfaces

Function

Digital input modules facilitate the connection of proximity sensors or other digital 24 V DC sensors (inductive, capacitive, light barriers, etc.), PNP.

Applications

- Input module for 24 V DC sensor signals
- Double slave, two slaves in one housing
- M8 plug connection technology, single allocation
- The input status of each input signal is indicated on an allocated green LED
- 24 V DC supply for all connected sensors provided via the ("yellow") AS-interface cable
- Peripherals fault LED for short circuit/undervoltage of sensor supply for each AS-interface slave
- Modules support A/B mode in accordance with Spec. V2.11
- Bus connection 2x M12 for bus in and bus out
- Bus and auxiliary power supply looped through for cascading with output modules



General technical data		
Type	ASI-8DI-M8-3POL	
Digital inputs	No. of inputs	8
	Power supply 24 V DC	From the AS-interface ("yellow" cable)
	Intrinsic current consumption of electronics [mA]	Typically 35 (inputs not connected)
	Input current at 24 V DC (from sensor) [mA]	Typically 6
	Fuse protection for sensors and electronic module	Internal thermal short circuit protection
	Max. current consumption per sensor [A]	0.24
	Max. current consumption of sensor supply, residual current per slave [A]	0.24
	Nominal operating voltage for sensors [V]	24
	Operating voltage range for sensors [V DC]	18 ... 30
	Protection against polarity reversal	For logic and sensor supply and AS-interface
	Electrical separation	
	• between the channels	None
	• to the AS-interface system	None
	Logic level	
• Signal 0 [V]	≤5	
• Signal 1 [V]	≥-11	
Input delay [ms]	Typically 3	
Switching logic	PNP	
Input characteristic curve	To IEC 1131-2	

General technical data		
Type	ASI-8DI-M8-3POL	
General data	Protection class to EN 60529	IP65/IP67 (when fully plugged in or fitted with protective cap)
	Material	Polybuteneterephthalate
	Dimensions (LxWxD) [mm]	151 x 30 x 30
	Weight [g]	190
LED displays	Inputs	8 green
	AS-interface LED	Power/green
	FAULT-LED (fault 1, fault 2)	Fault LED/red per slave
AS-interface connection/load voltage connection	Connection with the AS-interface	Via M12 connecting cables, 4-wire
	Watchdog function	Active after 50 ms
	Peripherals fault/diagnostics	Short circuit/overload (thermal fuse on each channel) in accordance with specification c.S.2.1, two red fault LEDs Automatic voltage return
	AS-interface bus voltage [V]	26.5 ... 31.6
	Total current consumption of AS-interface [mA]	Max. 350
	Current-carrying capacity of M12 pins [A] (AS-i, AUX)	Max. 4
	AS-interface data	
	• IO code	0 _h
	• ID code 1	A _h
	• ID code 2	E _h
• Profile	S-0.A.E	
AS-interface address (factory setting)	#1A, #2A	
AS-interface specification	2.11 (compatible with 3.0)	

Operating and environmental conditions		
Type	ASI-8DI-M8-3POL	
Ambient temperature [°C]	-5 ... +50	
Storage temperature [°C]	-20 ... +70	
Corrosion resistance class CRC ¹⁾	1	
PWIS criterion	PWIS-free	
Material note	Conforms to RoHS	

1) Corrosion resistance class 1 as per Festo standard 940 070
Components requiring low corrosion resistance. Transport and storage protection. Parts that do not have primarily decorative surface requirements, e.g. in internal areas that are not visible or behind covers.

Certifications		
In accordance with EU directive (ATEX directive)		
ATEX category gas	II 3G	
Ex-ignition protection type gas	Ex na II T5 X	
ATEX category dust	II 3D	
EX-ignition protection type dust	Ex tD A22 IP65 T80° C X	
ATEX ambient temperature [°C]	-5 ≤ Ta ≤ +50	
Certification	c UL us recognized (OL)	
CE mark (see declaration of conformity)	In accordance with EU explosion protection directive (ATEX)	

-  - Note

For the operation of device combinations in hazardous areas, the lowest common zone, temperature class and ambient temperature of the individual devices determine the possible use of the entire module.

Connection and display components

ASI-8DI-M8-3POL

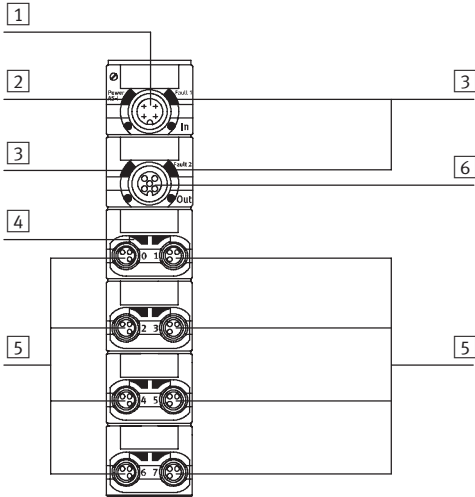

- 1 AS-interface connection, incoming
- 2 Status LED (green)
- 3 Red LED for short circuit/overload display
- 4 Green LED for status display (one LED per input)
- 5 Sensor connections
- 6 AS-interface connection, outgoing

Pin allocation for sensor connections ASI-8DI-M8-3POL

Pin allocation	Pin	Signal	Description	Pin	Signal
	1	24 V DC	Operating voltage 24 V DC	1	24 V
	3	0 V	Operating voltage 0 V	3	0 V
	4	Ix*	Sensor signal	4	Ix+1*

* Ix = Input x

AS-interface® components

Compact I/O modules and valve interfaces

Function

Combined digital input and output modules permit the connection of proximity sensors or other 24 V DC sensors (inductive, capacitive, etc.) as well as up to 3 consuming devices 24 V DC/1 A. The electrical outputs activate actuators such as individual valves, lamps, signal equipment and many more.

Note
Optimum actuation for valves with M12 central plug.

Plugs with double allocation are separated using a T-adaptor, DUO plug or DUO cable.

Applications

- Input/output module for 24 V DC sensor signals and actuators, PNP
- Single slave, contains an AS-interface chip
- M12 plug connection technology, 5-pin, double allocation
- Peripherals fault LED for short circuit/undervoltage of sensors or actuators

- Modules support A/B mode in accordance with Spec. V2.11
- Bus connection 2x M12 for bus in and bus out
- Bus and auxiliary power supply looped through for cascading with further output modules
- Inputs:
 - The input status of each input signal is indicated on an allocated green LED
 - 24 V DC supply for all connected sensors provided via the ("yellow") AS-interface cable
- Outputs:
 - The output status of each output signal is indicated on an allocated yellow LED
 - 24 V DC supply for all connected actuators is provided via the ("black") AS-interface cable



General technical data		
Type	ASI-4DI3DO-M12x2-5POL-Z	
Digital inputs	No. of inputs	4
	Power supply 24 V DC	From the AS-interface ("yellow" cable)
	Intrinsic current consumption of electronics [mA]	Typically 35 (inputs not connected)
	Input current at 24 V DC (from sensor) [mA]	Typically 6
	Fuse protection for sensors	Internal thermal short circuit protection
	Max. current consumption per sensor [A]	0.24
	Max. current consumption of sensor supply, residual current per slave [A]	0.25
	Nominal operating voltage for sensors [V]	24
	Operating voltage range for sensors [V DC]	18 ... 30
	Protection against polarity reversal	For logic and sensor supply and AS-interface
	Electrical separation	
	• between the channels	None
	• to the AS-interface system	Yes
	Logic level	
	• Signal 0 [V]	≤5
	• Signal 1 [V]	≥-11
	Input delay [ms]	Typically 3
	Switching logic	PNP
	Input characteristic curve	To IEC 1131-2

General technical data		
Type	ASI-4DI3DO-M12x2-5POL-Z	
Digital outputs	No. of outputs	3
	Allocation of outputs	Socket 3 with double allocation, socket 4 with single allocation
	Version of the actuator connection	4x M12, 5-pin
	Power supply 24 V DC	From the auxiliary power supply, "black" AS-interface cable
	Max. output current per channel [A]	1.0, 2 outputs can be switched together
	Operating voltage [V DC]	24 ±25%
	Fuse protection for power output	Internal thermal short circuit protection for each output
	Protection against polarity reversal	For actuator supply 24 V/0 V
	Switching logic	PNP
	Output characteristic curve	To ICE 1131-2
	Electrical separation	None
	<ul style="list-style-type: none"> between the channels to the AS-interface system 	Yes
	Voltage drop across the output [V]	<1.5
	Limitation of inductive switch-off voltage [V]	-10 ... -45
	LED displays	
<ul style="list-style-type: none"> Inputs Outputs AS-interface LED AUX-PWR-LED FAULT-LED 	4 green 3 yellow Power/green Auxiliary power supply/green Fault LED/red	
General data	Protection class to EN 60529	IP65/IP67 (when fully plugged in or fitted with protective cap)
	Material	Polybuteneterephthalate
	Dimensions (LxWxD) [mm]	151 x 30 x 30
	Weight [g]	165
AS-interface connection/load voltage connection	Connection with the AS-interface	Via M12 connecting cables, 4-wire
	Watchdog function	Active after 50 ms
	Peripherals fault/diagnostics	Short circuit/overload (thermal fuse on each channel) in accordance with specification C.S.2.1, two red fault LEDs Automatic voltage return
	AS-interface bus voltage [V]	26.5 ... 31.6
	Total current consumption of AS-interface [mA]	Max. 250
	Current-carrying capacity of M12 pins (AS-interface, AUX) [A]	Max. 4
	AS-interface data	
	<ul style="list-style-type: none"> IO code ID code 1 ID code 2 Profile 	7h A _h 2h S-7.A.2
	AS-interface address (factory setting)	#0A
	AS-interface specification	2.11 (compatible with 3.0)

Operating and environmental conditions		
Type	ASI-4DI3DO-M12x2-5POL-Z	
Ambient temperature	[°C]	-5 ... +50
Storage temperature	[°C]	-20 ... +70
Corrosion resistance class CRC ¹⁾		1
Material note	Conforms to RoHS	
PWIS criterion	PWIS-free	

1) Corrosion resistance class 1 as per Festo standard 940 070
 Components requiring low corrosion resistance. Transport and storage protection. Parts that do not have primarily decorative surface requirements, e.g. in internal areas that are not visible or behind covers.

Certifications	
This product is certified for operation in the EX range as per EU-ATEX guideline	
ATEX category gas	II 3G
Ex-ignition protection type gas	Ex na II T5 X
ATEX category dust	II 3D
EX-ignition protection type dust	Ex tD A22 IP65 T80° C X
ATEX ambient temperature	[°C] -5 ≤ Ta ≤ +50
Certification	c UL us recognized (OL)
CE mark (see declaration of conformity)	In accordance with EU explosion protection directive (ATEX)

 - Note

For the operation of device combinations in hazardous areas, the lowest common zone, temperature class and ambient temperature of the individual devices determine the possible use of the entire module.

Connection and display components

ASI-4DI3DO-M12x2-5POL-Z

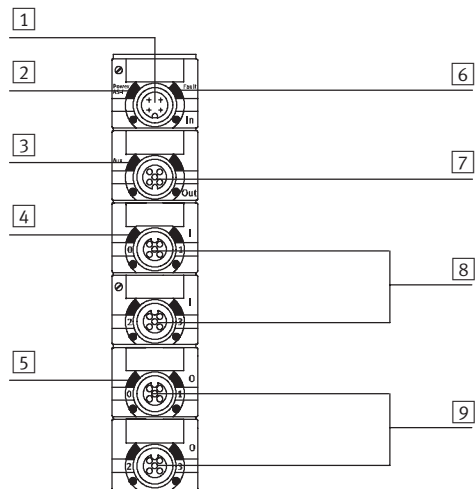

- 1 AS-interface connection, incoming
- 2 Status LED (green)
- 3 Green LED for load voltage display
- 4 Green LED for status display (one LED per input)
- 5 Yellow LED for status display (one LED per output)
- 6 Red LED for short circuit/overload display
- 7 AS-interface connection, outgoing
- 8 Sensor connections
- 9 Outputs

Pin allocation for sensor connections ASI-4DI3DO-M12X2-5POL-Z

Pin allocation	Pin	Signal	Description
	1	24 V DC	Operating voltage 24 V DC
	2	Ix*+1	Sensor signal
	3	0 V	Operating voltage 0 V
	4	Ix*	Sensor signal
	5	Earth	Earth terminal

* Ix = Input x

Pin allocation for outputs ASI-4DI3DO-M12X2-5POL-Z

Pin allocation	Outputs 1 and 2			Output 3		
	Pin	Signal	Description	Pin	Signal	Description
	1	n.c.	Not connected	1	n.c.	Not connected
	2	Ox*+1	Output	2	n.c.	Not connected
	3	0 V	Operating voltage 0 V	3	0 V	Operating voltage 0 V
	4	Ox*	Output	4	Ox*+2	Output
	5	Earth	Earth terminal	5	Earth	Earth terminal

* Ox = Output

AS-interface® components

Compact I/O modules and valve interfaces



Function

Valve interfaces as combined digital input and output modules permit the connection of proximity sensors or other 24 V DC sensors (inductive, capacitive, etc.) as well as up to 2 consuming devices 24 V DC/1 A. The electrical outputs can be connected via pre-fitted, pre-assembled and tested connecting cables. Input sockets with double allocation are separated using a T-adapter, DUO plug or DUO cable.

Applications

- Input/output module for 24 V DC sensor signals and valves, PNP
- Single slave, contains an AS-interface chip
- M12 plug connection technology, 5-pin, double allocation
- Pre-assembled cables for valves
- Peripherals fault LED for short circuit/undervoltage of sensors or actuators

- Modules support A/B mode in accordance with Spec. V2.11
- Bus connection 2x M12 for bus in and bus out
- Bus and auxiliary power supply looped through for cascading with further output modules
- Inputs:
 - The input status of each input signal is indicated on an allocated green LED
 - 24 V DC supply for all connected sensors provided via the ("yellow") AS-interface cable
- Outputs:
 - The output status of each output signal is indicated on an allocated yellow LED on the module and the valve plug.
 - 24 V DC supply for all connected actuators/valves is provided via the ("black") AS-interface cable

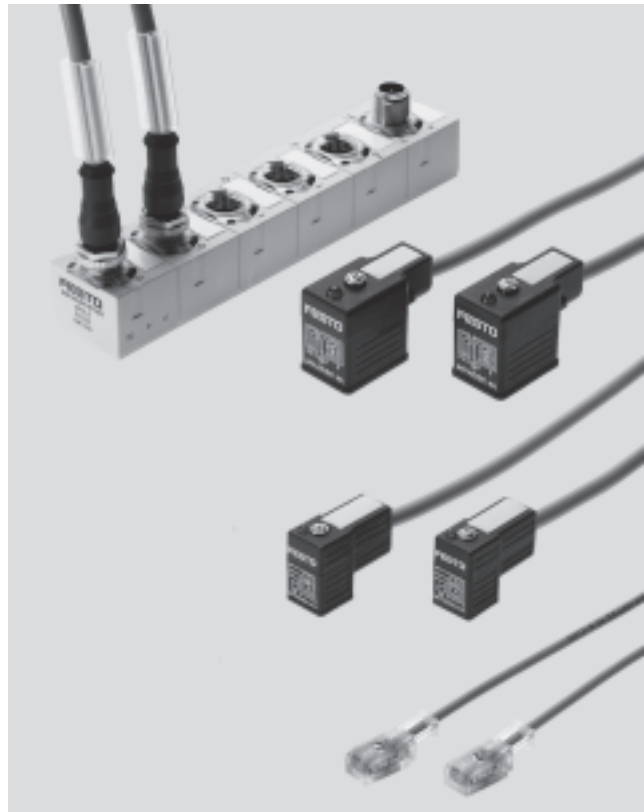

General technical data		ASI-4DI2DO-2xMF-Z	ASI-4DI2DO-2xMEB-Z	ASI-4DI2DO-2xMZB9-Z
Type				
Digital inputs	No. of inputs	4		
	Power supply 24 V DC	From the AS-interface ("yellow" cable)		
	Intrinsic current consumption of electronics [mA]	Typically 35 (inputs not connected)		
	Input current at 24 V DC (from sensor) [mA]	Typically 6		
	Fuse protection for sensors	Internal thermal short circuit protection		
	Max. current consumption per sensor [A]	0.24		
	Max. current consumption of sensor supply, residual current per slave [A]	0.25		
	Nominal operating voltage for sensors [V]	24		
	Operating voltage range for sensors [V DC]	18 ... 30		
	Protection against polarity reversal	For logic and sensor supply and AS-interface		
	Electrical separation			
	• between the channels	None		
	• to the AS-interface system	Yes		
	Logic level			
	• Signal 0 [V]	≤5		
	• Signal 1 [V]	≥-11		
	Input delay [ms]	Typically 3		
	Switching logic	PNP		
	Input characteristic curve	To IEC 1131-2		

General technical data				
Type		ASI-4DI2DO-2xMF-Z	ASI-4DI2DO-2xMEB-Z	ASI-4DI2DO-2xMZB9-Z
Digital inputs	Power supply 24 V DC	From the auxiliary power supply, "black" AS-interface cable		
	Max. output current per channel [A]	1.0, 2 outputs can be switched together		
	Operating voltage [V DC]	24 ±25%		
	Switching logic	PNP		
	Output characteristic curve	To ICE 1131-2		
	Electrical separation	None		
	<ul style="list-style-type: none"> between the channels to the AS-interface system 	Yes		
Solenoid coils	LED displays	<ul style="list-style-type: none"> Inputs: 4 green Outputs: 3 yellow AS-interface LED: Power/green AUX-PWR-LED: Auxiliary power supply/green FAULT-LED: Fault LED/red 		
	No. of connectable solenoid coils	2		
	Valve connection	F coils, DIN 175301, type B industrial standard, with LED	EB coils, DIN 175301, type C, with LED	ZC coils, for example Festo CPE10/14-M1BH, with LED
	Cable length [m]	0.5 m pre-assembled cable per connection		
	Cable type	Round cable 3x 0.75, polyvinyl chloride, colour grey		Round cable 2x 0.25, polyurethane, colour grey
	Valve actuator design	Short circuit and overload proof, voltage peaks limited		
	Protection class to EN 60529	IP65/IP67 (when fully plugged in or fitted with protective cap)		
General data	Material	<ul style="list-style-type: none"> Module: Polybuteneterephthalate M12 plug: Elastollan/black Valve plug: Polyurethane elastomer, black 		
	Dimensions (LxWxD) [mm]	151 x 30 x 30		
	Weight [g]	395	374	304
	AS-interface connection/load	Via M12 connecting cables, 4-wire		
	Watchdog function	Active after 50 ms		
AS-interface voltage connection	Peripherals fault/diagnostics	Short circuit/overload (thermal fuse on each channel) in accordance with specification C.S.2.1, two red fault LEDs Automatic voltage return		
	AS-interface bus voltage [V]	26.5 ... 31.6		
	Total current consumption of AS-interface [mA]	Max. 250		
	Current-carrying capacity of M12 pins (AS-interface, AUX) [A]	Max. 4		
	AS-interface data	<ul style="list-style-type: none"> IO code: 7_h ID code 1: A_h ID code 2: 2_h Profile: S-7.A.2 		
	AS-interface address (factory setting)	#0A		
	AS-interface specification	2.11 (compatible with 3.0)		

Operating and environmental conditions				
Type		ASI-4DI2DO-2xMF-Z	ASI-4DI2DO-2xMEB-Z	ASI-4DI2DO-2xMZB9-Z
Ambient temperature	[°C]	-5 ... +50		
Storage temperature	[°C]	-20 ... +70		
Corrosion resistance class CRC ¹⁾		1		
Material note		Conforms to RoHS		
PWIS criterion		PWIS-free		

1) Corrosion resistance class 1 as per Festo standard 940 070
Components requiring low corrosion resistance. Transport and storage protection. Parts that do not have primarily decorative surface requirements, e.g. in internal areas that are not visible or behind covers.

Certifications	
This product is certified for operation in the EX range as per EU-ATEX guideline	
ATEX category gas	II 3G
Ex-ignition protection type gas	Ex na II T5 X
ATEX category dust	II 3D
EX-ignition protection type dust	Ex tD A22 IP65 T80° C X
ATEX ambient temperature	[°C] $-5 \leq T_a \leq +50$
Certification	c UL us recognized (OL)
CE mark (see declaration of conformity)	In accordance with EU explosion protection directive (ATEX)

 Note

For the operation of device combinations in hazardous areas, the lowest common zone, temperature class and ambient temperature of the individual devices determine the possible use of the entire module.

Connection and display components

ASI-4DI2DO-2x...-Z

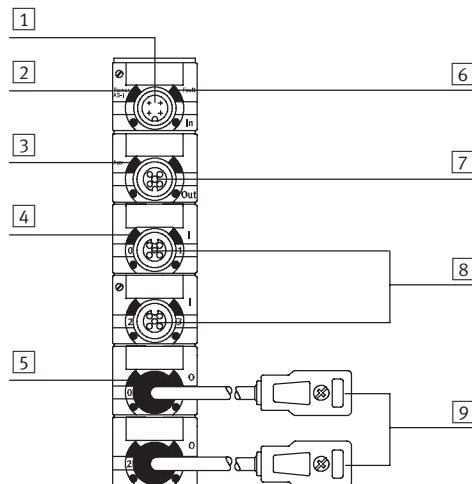

- 1 AS-interface connection, incoming
- 2 Status LED (green)
- 3 Green LED for load voltage display
- 4 Green LED for status display (one LED per input)
- 5 Yellow LED for status display (one LED per output)
- 6 Red LED for short circuit/overload display
- 7 AS-interface connection, outgoing
- 8 Sensor connections
- 9 Outputs

Pin allocation for sensor connections ASI-4DI2DO-2x...-Z			
Pin allocation	Pin	Signal	Description
	1	24 V DC	Operating voltage 24 V DC
	2	Ix*+1	Sensor signal
	3	0 V	Operating voltage 0 V
	4	Ix*	Sensor signal
	5	Earth	Earth terminal

* Ix = Input x

Dimensions

Download CAD data → www.festo.com

ASI-8DI-M8-3POL

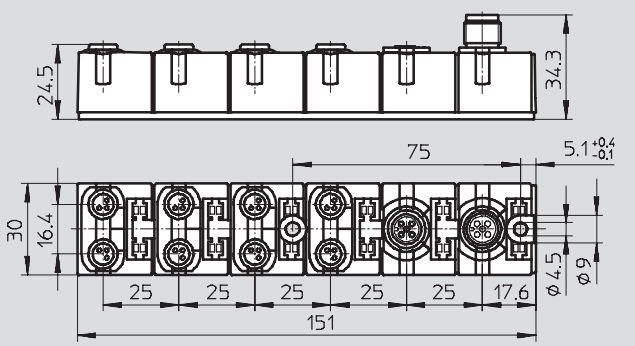

ASI-4DI3DO-M12x2-5POL-Z

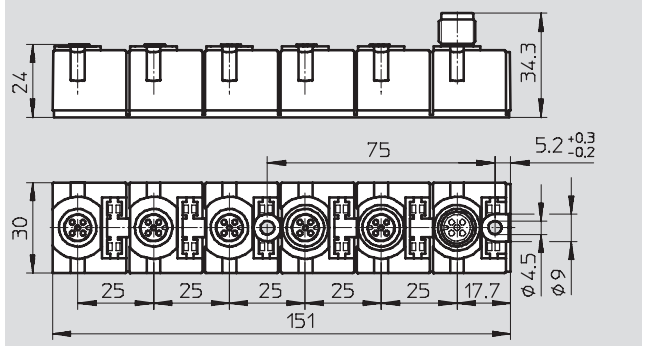

ASI-4DI2DO-2xMF-Z

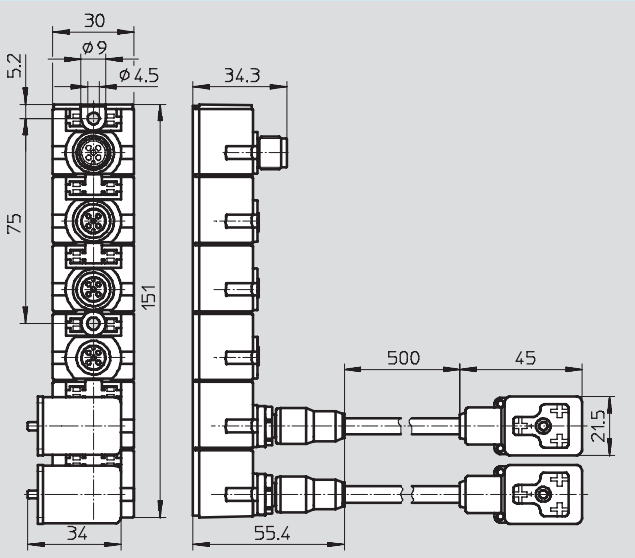

ASI-4DI2DO-2xMEB-Z

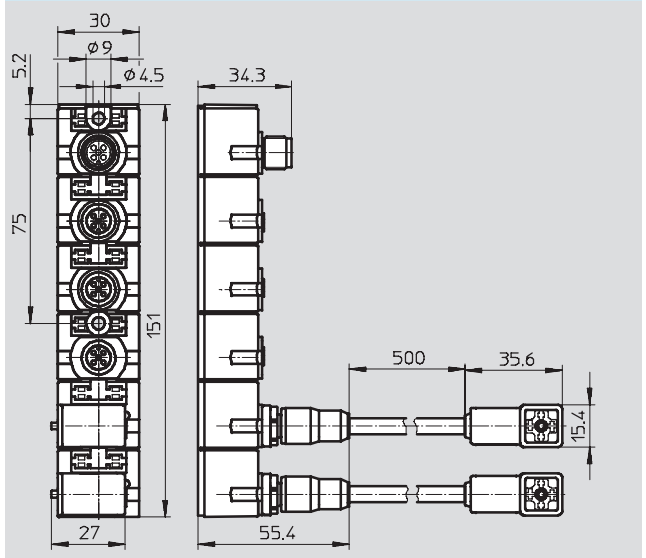

ASI-4DI2DO-2xMZB9-Z

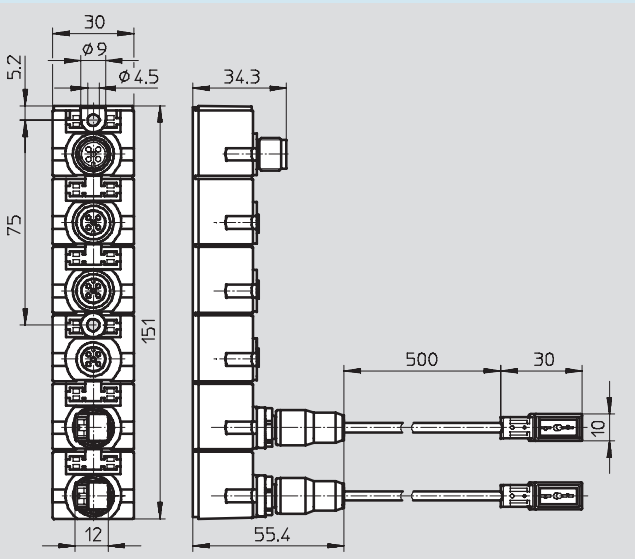

AS-interface® components

Compact I/O modules and valve interfaces

FESTO

Dimensions

Download CAD data → www.festo.com

NEBV-B2W3P-F-...-M12G5

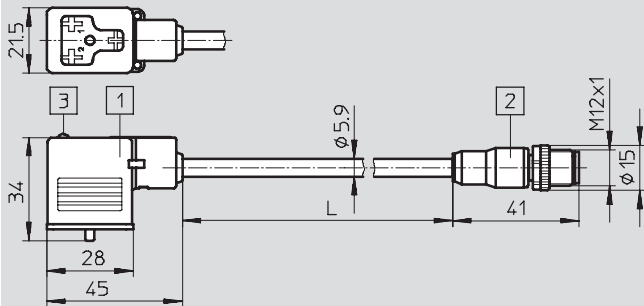

- 1 Socket type BI
- 2 Straight plug M12
- 3 LED illuminated area

	L [m]
NEBV-B2W3P-F-0,5-M12G5	0.5
NEBV-B2W3P-F-2,5-M12G5	2.5

NEBV-C1W3P-F-...-M12G5

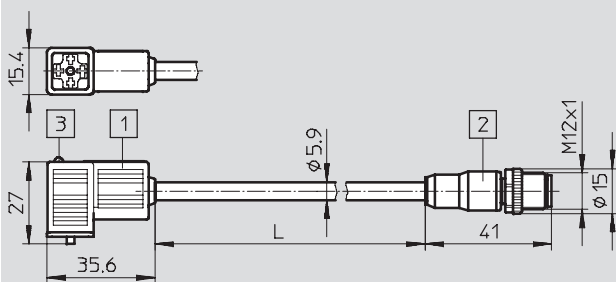

- 1 Socket type C
- 2 Straight plug M12
- 3 LED illuminated area

	L [m]
NEBV-C1W3P-F-0,5-M12G5	0.5
NEBV-C1W3P-F-2,5-M12G5	2.5

NEBV-Z2W2P-...-M12G5

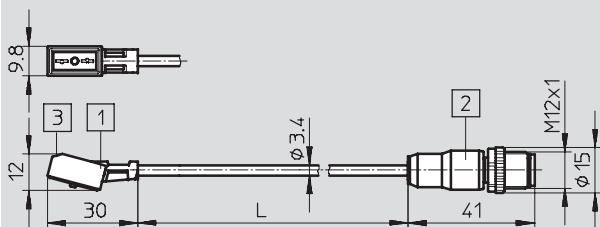

- 1 Socket KMYZ-9
- 2 Straight plug M12
- 3 LED illuminated area

	L [m]
NEBV-Z2W2P-F-0,5-M12G5	0.5
NEBV-Z2W2P-F-2,5-M12G5	2.5

Dimensions

Download CAD data → www.festo.com

NEDU-M8D3-M12T4

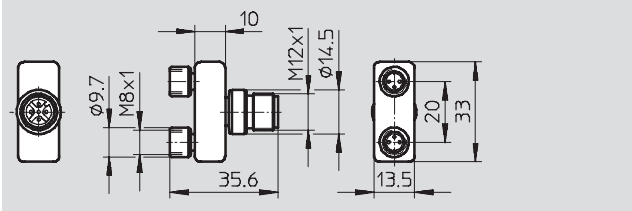

NEDU-M12D5-M12T5

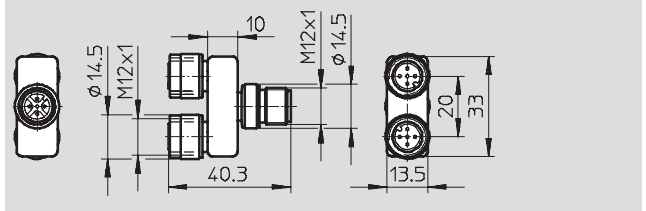

NEBU-M12G5-F-0,2-M12G4

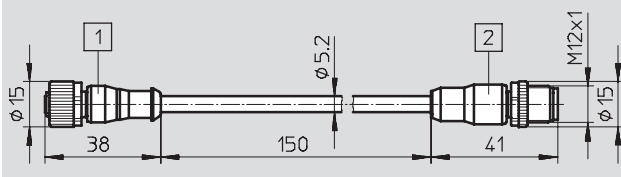





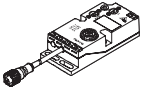

- 1 Straight socket M12
- 2 Straight plug M12

AS-interface® components

Compact I/O modules and valve interfaces – Accessories

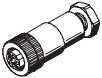
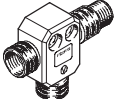
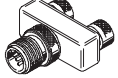
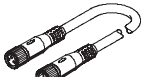
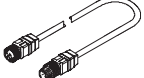
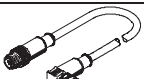





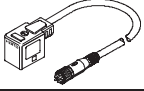
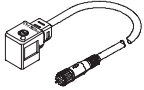
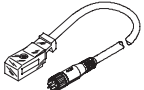

FESTO

Ordering data				
	Description		Type	Part No.
Bus connection				
	AS-interface flat cable, yellow	100 m	KASI-1,5-Y-100	18940
	AS-interface flat cable, black	100 m	KASI-1,5-Z-100	18941
	Cable distributor (yellow and black)	Via 2x M12, 4-pin	ASI-KVT-FKx2-M12	527474
	Cable cap for flat cable (scope of delivery 50 pieces)		ASI-KK-FK	18787
	Cable sleeve (scope of delivery 20 pieces)		ASI-KT-FK	165593
	M12 socket for flat cable		ASI-SD-FK-M12	18788
	M12 socket for flat cable	With PG13.5 connector	ASI-SD-PG-M12	18789
T-type plug connector				
	T-adapter for DH-485, M12 5-pin		FB-TA-M12-5POL	171175
	Plug M12, 2x socket M12 5-pin		NEDU-M12D5-M12T4	541596
	Plug M8, 3-pin, to M12 4-pin		NEDU-M8D3-M12T4	541597
Connecting cables				
	Modular system for connecting cables → Internet: nebu		NEBU-...	-
	Connecting cable, straight plug, straight socket	M12, 4-pin/5-pin, 0.2 m	NEBU-M12G5-F-0.2-M12G4	542129
		M12, 4-pin, 2.5 m	KM12-M12-GSGD-2,5	18684
		M12, 4-pin, 5.0 m	KM12-M12-GSGD-5	18686
	Connecting cable, straight plug, angled socket	M12, 4-pin, 1.0 m	KM12 M12-GSWD-1-4	185499
	DUO cable M12 4-pin via 2xM8, 3-pin	2x straight socket	KM12-DUO-M8-GGD	18685
		2x straight/angled socket	KM12-DUO-M8-GDWD	18688
		2x angled socket	KM12-DUO-M8-WDWD	18687
	Connecting cable, straight plug, straight socket	M8, 0.5 m	KM8-M8-GSGD-0,5	175488
		M8, 1.0 m	KM8-M8-GSGD-1	175489
		M8, 2.5 m	KM8-M8-GSGD-2,5	165610
		M8, 5.0 m	KM8-M8-GSGD-5	165611

AS-interface® components

Compact I/O modules and valve interfaces – Accessories



FESTO

Ordering data				
	Description		Type	Part No.
Connecting cables for individual valve interfaces				
	Connecting cable, straight plug, angled socket type B for F coil	M12, straight, 5-pin, 0.5 m	NEBV-B2W3P-F-0,5-M12G5	542130
		M12, straight, 5-pin, 2.5 m	NEBV-B2W3P-F-2,5-M12G5	542133
	Connecting cable, straight plug, angled socket type C for EB coil	M12, straight, 5-pin, 0.5 m	NEBV-C1W3P-F-0,5-M12G5	542131
		M12, straight, 5-pin, 2.5 m	NEBV-C1W3P-F-2,5-M12G5	542134
	Connecting cable, straight plug, angled socket type KMYZ-9 for ZC coil	M12, straight, 5-pin, 0.5 m	NEBV-Z2W2P-0,5-M12G5	542132
		M12, straight, 5-pin, 2.5 m	NEBV-Z2W2P-2,5-M12G5	542135
DUO plugs				
	Plug M12 for 2 sensor cables	4-pin, PG11	SEA-GS-11-DUO	18779
		5-pin, PG11	SEA-5GS-11-DUO	192010
Sensor plugs				
	Straight sensor plug	M12, 5-pin, PG7	SEA-M12-5GS-PG7	175487
	Straight sensor plug	M12, 4-pin, PG7	SEA-GS-7	18666
	Straight sensor plug	M12, PG9, 4-pin	SEA-GS-9	18778
	Straight sensor plug for cable Ø 2.5 mm	M12, 4-pin	SEA-4GS-7-2,5	192008
	Straight sensor plug	M8, screw-in, 3-pin	SEA-3GS-M8-S	192009
	Straight sensor plug	M8, solderable, 3-pin	SEA-GS-M8	18696
	Protective cap	M12	ISK-M12	165592
	Protective cap	M8	ISK-M8	177672

AS-interface® components

Compact I/O modules and valve interfaces – Accessories

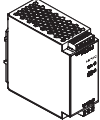
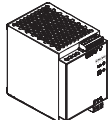
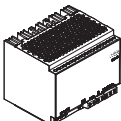

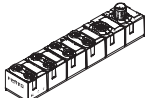
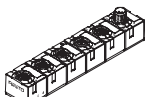
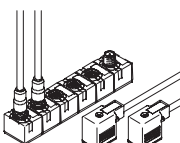
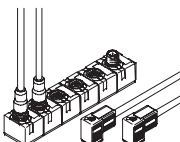
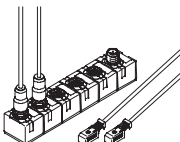
FESTO

Ordering data			
	Description	Type	Part No.
Miscellaneous			
	Primary switched mode modular power supply AS-i power supply 4.8 A	SVG-1/230VAC-ASI-5A	547869
	Primary switched mode modular power supply 24 VDC power supply 5 A	SVG-1/230-24VDC-5A	547867
	Primary switched mode modular power supply 24 VDC power supply 10 A	SVG-1/230-24VDC-10A	547868
	Addressing device (power supply plug included in scope of delivery)	ASI-PRG-ADR	18959
	Addressing cable	KASI-ADR	18960
I/O modules			
	AS-interface input module for 8 inputs M8	ASI-8DI-M8-3POL	542124
	AS-interface input/output module for 4 inputs/3 outputs M12	ASI-4DI3DO-M12X2-5POL-Z	542125
	AS-interface input/output module for 4 inputs/2 outputs	ASI-4DI2DO-2xMF-Z	542126
	AS-interface input/output module for 4 inputs/2 outputs	ASI-4DI2DO-2xMEB-Z	542127
	AS-interface input/output module for 4 inputs/2 outputs	ASI-4DI2DO-2xMZB9-Z	542128

AS-interface® components

Compact I/O modules and valve interfaces – Accessories

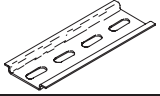
FESTO

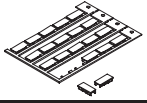
Ordering data			
	Description	Type	Part No.
Mountings			
	H-rail to EN 60715	NRH-35-2000	35430
	Mounting for H-rail	CP-TS-HS35	170169
Inscription labels			
	Inscription labels 8x20 mm in frames (20 pieces)	IBS-8x20	539388

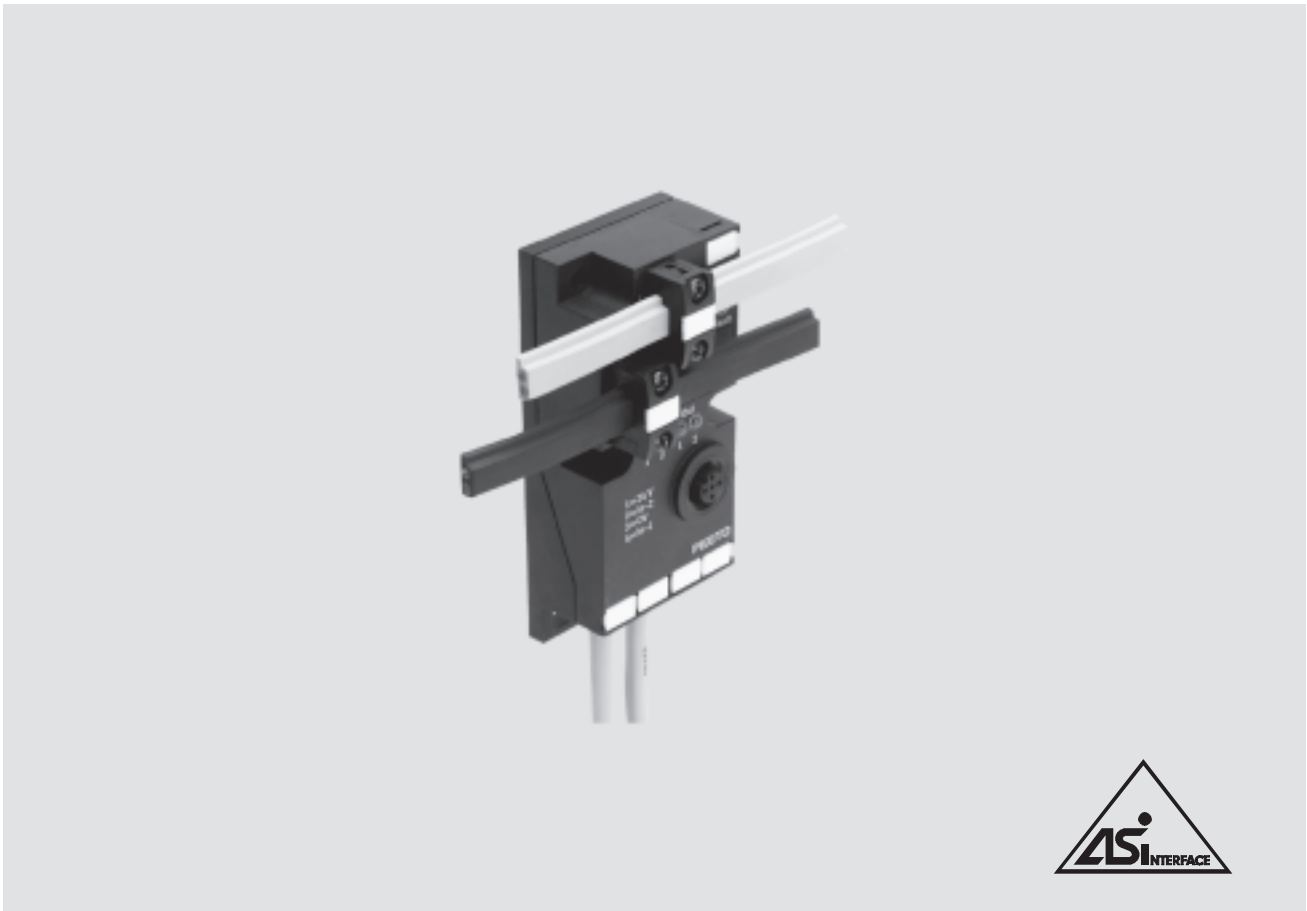

Individual valve interface

General description and overview of variants

- With pre-assembled valve plug socket
- With open cable end
- As an input module
- For DNCV actuation (cylinder/valve combination)

Quick connection of valves to the AS-interface by means of Festo plug and work™.

All individual valve interfaces have two inputs for recording input signals via cylinder proximity sensors, inductive, capacitive or optical sensors.

Flexible installation

Install ASI-EVA at the front of the machine for easy servicing – the valves must be close to the actuator in the machine.

The load voltage (auxiliary power supply via the black cable) can be connected/disconnected separately.

Optimal cost-effectiveness

The ASI-EVA is a cost-effective way of connecting two valves or solenoid coils to the AS-interface:

- One electronic unit for all
- Reduced logistics
- Quick installation
- Flexible assembly
- Wide range of accessories
- Optimal pneumatic sizing

AS-interface® components

Individual valve interface ASI-EVA – Overview

FESTO

Mounting options

Installation

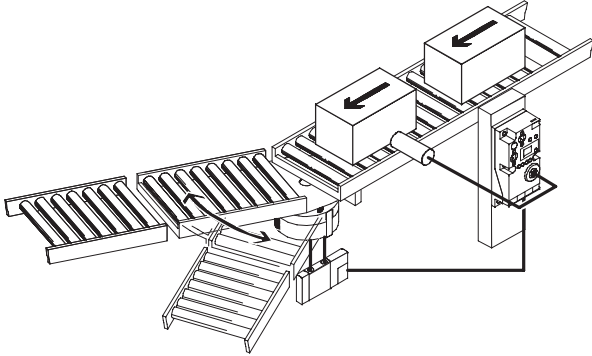

The AS-interface offers new and easy installation concepts thanks to the long cable outlets of the individual valve interface ASI-EVA.

The electronics are installed at the front of the machine. This ensures that the LEDs and control elements are easy to read and operate.

Installation and mounting is very straightforward.

The valve can be mounted close to the cylinder and is easily connected via the pre-fitted cable outlet (0.5 or 1 m). This makes for shorter tubing lengths, quick motion sequences and a reduction in the amount of compressed air used.

Mounting

On an H-rail

You will need an adapter kit type CP-TS-HS35 in order to mount the individual valve interface on an H-rail (DIN mounting rail). This is available as an accessory.

On an ITEM profile

The individual valve interface can be mounted directly on an ITEM profile with a gap of 40 mm using the two mounting holes on the left-hand side of the ASI-EVA housing.

On a cylinder

Mounting on a cylinder or stopper cylinder is easily accomplished using slot nuts, for example. The different widths of the cylinders are either compensated using the two elongated

holes on the ASI-EVA or else the ASI-EVA can be mounted laterally via the two holes on the left-hand side of the housing.

AS-interface® components

Individual valve interface ASI-EVA – Pre-assembled connection sockets

FESTO

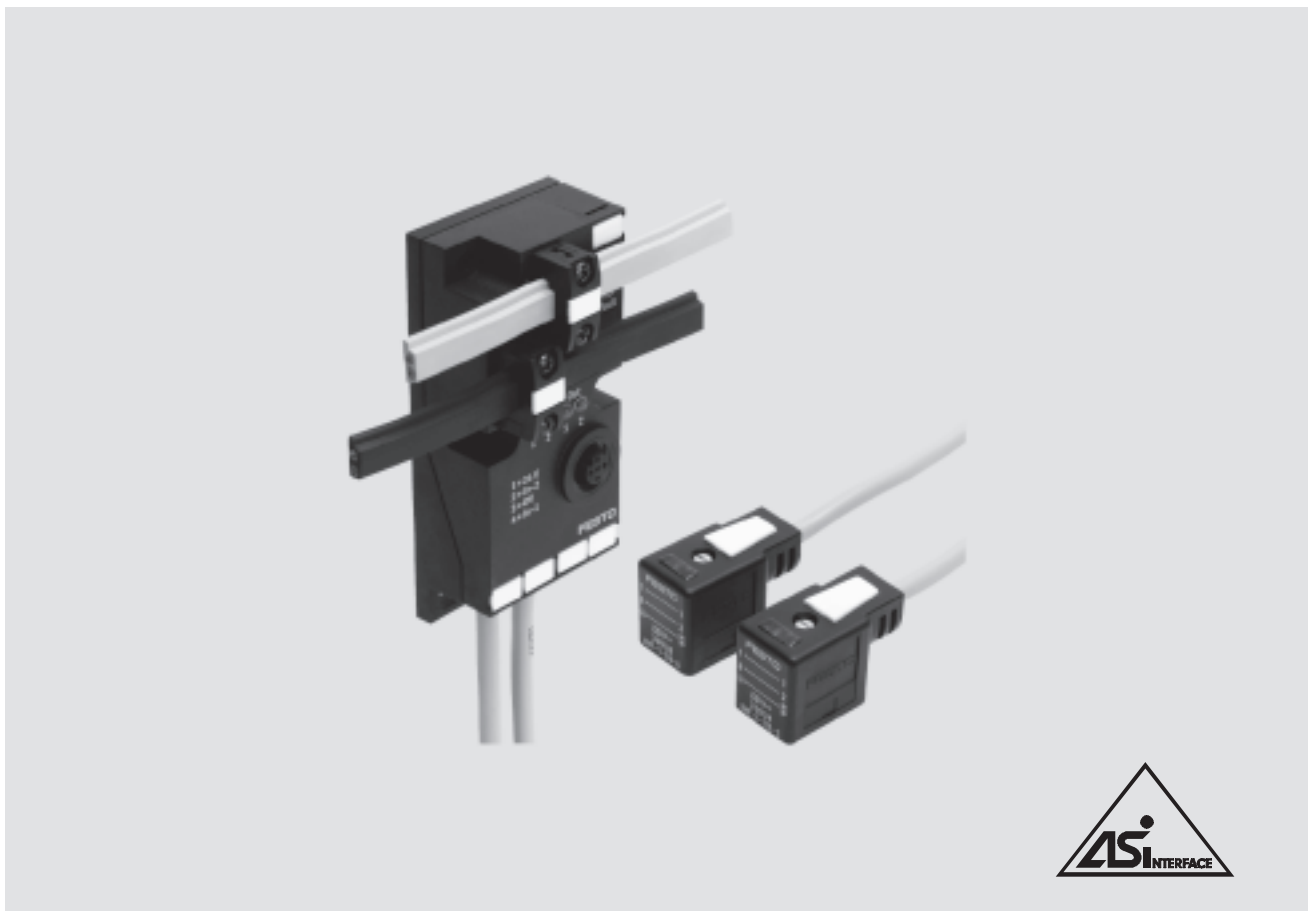

Individual valve interface to Specification V2.1¹⁾ – With pre-assembled valve plug sockets

General description

- Ideal for Festo plug and work™. Supports the connection of almost all Festo valves
- The load voltage (auxiliary power supply via the black cable) can be connected/disconnected separately
- All individual valve interfaces have two inputs for recording input signals via cylinder proximity sensors, inductive, capacitive or optical sensors

Versions

- Cable length 0.5 m
- Valve connection sockets for Festo MF, MEB and ZC coils
- Modules equipped with one or two outputs can be supplied for optimum configuration of valves with one or two solenoid coils
- Valves with a rating of up to 6 watts (12 watts if only one output is switched in parallel) can be connected
- Inputs based on IEC 1131-2, DC 24 V, PNP
- Up to 200 mA per input

- Two inputs on one M12 socket
- Suitable for Festo M12 DUO plugs, for the DUO cables M12/2x M8 and the T-type plug connectors M12-2x M12 or M12-2x M8
- Status LEDs for each input
- Fault LED and enhanced diagnostics as per C.S.2.1¹⁾
- The auxiliary power supply is always integrated and can be subsequently switched off using the DIL switch
- Flat cable sockets are available (turned through 180° or standard) and must be ordered separately

Application

- Cost-effective connection of two valves to the AS-interface. Fast installation thanks to the Festo plug and work™ design.
- Decentralised machine and system structures, for example
- in conveyor technology
 - in sorting systems
 - in upstream machine functions
 - for individual drives or stopper cylinders
 - for service units and soft-start valves
 - for quarter turn and linear valve actuators in process engineering or water treatment

1) Slave compatible with SPEC V3.0

AS-interface® components

Individual valve interface ASI-EVA – Pre-assembled connection sockets

FESTO

Technical data		ASI-EVA- MF-2E1A-Z	ASI-EVA- MF-2E2A-Z	ASI-EVA- MEB-2E1A-Z	ASI-EVA- MEB-2E2A-Z	ASI-EVA- MZB9-2E1A-Z	ASI-EVA- MZB9-2E2A-Z	
Solenoid coils	Connectable solenoid coils	1	2	1	2	1	2	
	Cable length [m]	Pre-assembled cable, 0.5 m per connecting cable						
	Cable type	Round cable 3x 0.5 mm ² ; cable Ø 5.8 mm; polyurethane; colour: grey				Round cable 2x 0.25 mm ² ; polyvinyl chloride; colour: grey		
	Valve connection	F coils, DIN EN 175301, type B (industrial standard)		EB coils, DIN EN 175301, type C		ZC coils, e.g. Festo CPE10/14-M1BH		
	Valve actuator design	Short circuit and overload proof						
	External power supply 24 V DC	Can be selected using the DIL switch						
	Current-carrying capacity [A]	0,5	2x 0.25	0,5	2x 0.25	0,5	2x 0.25	
	Watchdog function	Active after 50 ms						
	Digital inputs	Number	2					
		Connection technology	M12, 5-pin socket with double allocation					
Sensor supply via AS-interface		Short circuit and overload proof						
Sensor connection		2-wire and 3-wire sensors, light barriers, etc.						
Type		IEC 1131-2, type 02						
Input circuitry		PNP (positive switching)						
Current-carrying capacity [mA]		Max. 200 per input, max. 200 all inputs						
Logic level [V]		On: 11 ... 30; off: -30 ... 5						
Reference potential		0 V						
Delay time [ms]		Typically 3 (at 24 V DC)						
AS-interface connection	Connection technology	AS-interface flat cable plug (must be ordered separately)						
	Voltage range [V DC]	26.5 ... 31.6, reverse polarity protected						
	Residual ripple [mVss]	20						
	Current consumption [mA]	Max. 12 (basic load of the electronics) • plus the current consumption of the digital inputs • plus the current consumption of the outputs if there is no auxiliary power supply Total current consumption of the ASI-EVA: max. 240						
Load voltage connection	Connection technology	AS-interface flat cable plug (must be ordered separately)						
	Nominal voltage [V DC]	24 ±10%						
	Residual ripple [Vss]	4						
	Current consumption [A]	Max. 0.5 (at 24 V)						
	Output voltage [V]	Approx. 1.4 V less than the load or AS-interface voltage						
LED displays	Outputs/inputs	Two each yellow/green						
	ASI-LED	Power/green						
	AUX-PWR-LED	Auxiliary power supply/green						
	FAULT-LED	Fault LED/red						
Diagnostics	Peripherals fault	To specification C.S.2.1, red FAULT-LED						
General data	Protection class (to EN 60529)	IP65 (fully assembled)						
	CE mark	Yes, in accordance with EU Directive 89/336/EEC						
	UL certification	Yes						
	Temperature range [°C]	Operation: -5 ... +50; storage/transport: -20 ... +70						
	Materials	Polyamide						
	Dimensions [mm]	Approx. 102 x 46 x 28.5						
	Weight [g]	200						
AS-interface data	ID code	ID = F _H ; ID1 = F _H ¹ ; ID2 = E _H						
	IO code	B _H						
	Profile	S-B.FE						

1) Factory setting, set to 0_H by some programming devices (Spec. V2.1) when addressing the slave

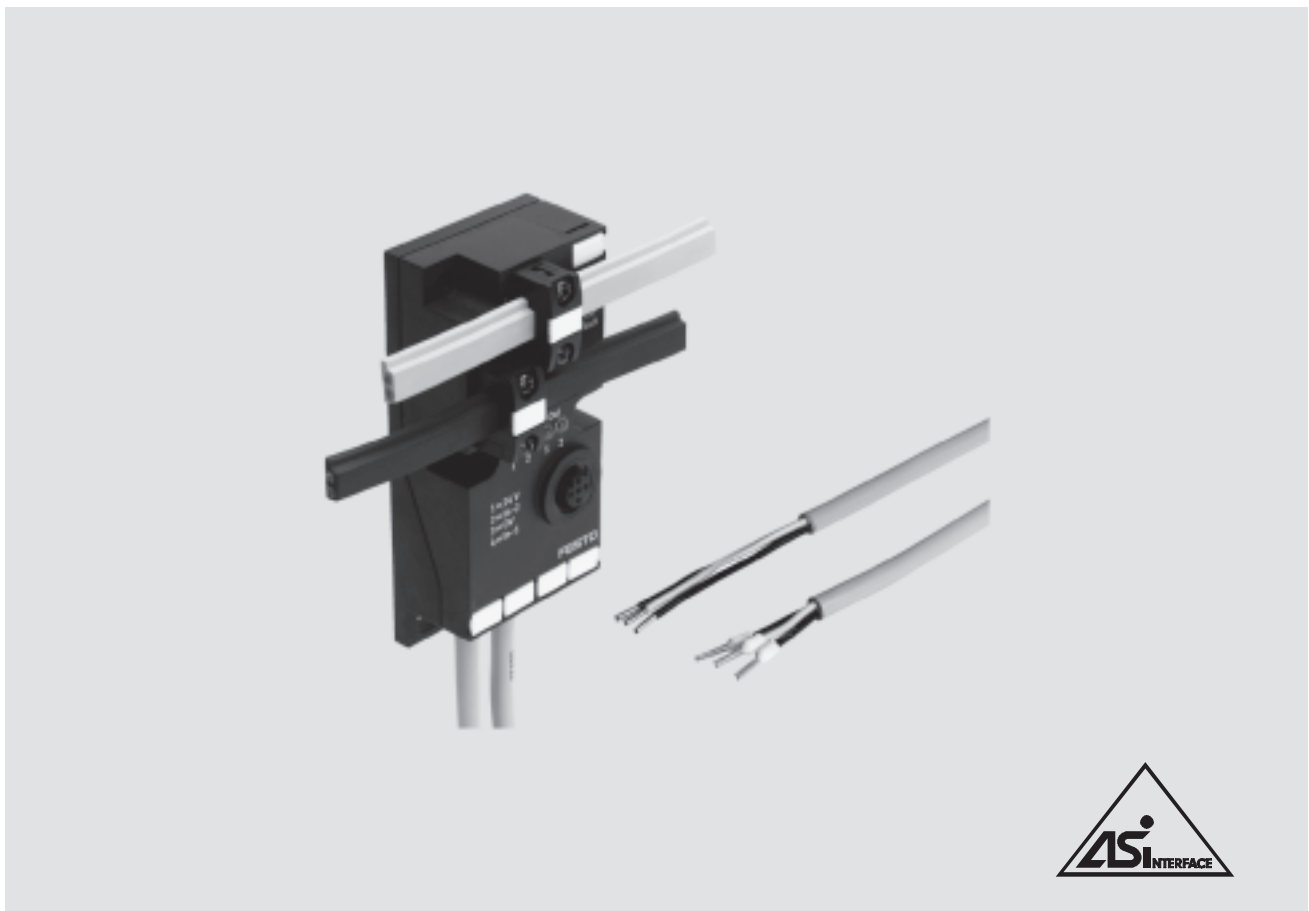

Individual valve interface to Specification V2.1¹⁾ – With open cable ends

General data

Ideal for the flexible connection of almost all valves and other consuming devices:

- Longer cable outlet of up to 1 m
- Pneumatic valves with special connector sockets
- Hydraulic valves
- Other consuming devices

All individual valve interfaces have two inputs for recording input signals via cylinder proximity sensors, inductive, capacitive or optical sensors.

The load voltage (auxiliary power supply via the black cable) can be connected/disconnected separately

Versions

- Cable length 1 m
- Can be supplied with one or two outputs
- Ideal for the quick connection of valve connection sockets using insulation displacement technology or conventional connection technology
- Valves and consuming devices with a rating of up to 6 watts (12 watts if only one output is switched in parallel) can be connected
- Inputs based on IEC 1131-2, DC 24 V, PNP
- Up to 200 mA per input
- Two inputs on one M12 socket
- Suitable for Festo M12 DUO plugs, for the DUO cables M12/2x M8 and the T-type plug connectors M12-2x M12 or M12-2x M8
- Status LEDs for each input
- Fault LED and enhanced diagnostics as per C.S.2.1¹⁾
- The auxiliary power supply is always integrated and can be subsequently switched off using the DIL switch
- Flat cable sockets are available (turned through 180° or standard) and must be ordered separately

Application

Flexible and cost-effective connection of one or two valves or other consuming devices to the AS-interface.

Decentralised machine and system structures, for example

- in conveyor technology
- in sorting systems
- in upstream machine functions
- for individual drives or stopper cylinders
- for service units and soft-start valves
- for quarter turn and linear valve actuators in process engineering or water treatment
- for applications outside of conventional pneumatics

1) Slave compatible with SPEC V3.0

AS-interface® components

Individual valve interface ASI-EVA – With open cable ends

FESTO

Technical data			
Type	ASI-EVA-K1-2E1A-Z	ASI-EVA-K1-2E2A-Z	
Outputs/valves	No. of outputs/valves	1	2
	Cable length [m]	1 m	
	Cable type	Round cable 3x 0.5 mm ² ; cable Ø 5.8 mm; polyurethane; colour: grey	
	Output/valve connection	Open cable end, 3-wire BL1 = 24 V, BL2 = 0 V, gr/ye = n.c.	Open cable end, 3-wire BL1 = 24 V, BL2 = 0 V, gr/ye = n.c.
	Valve actuator design	Short circuit and overload proof	
	External voltage supply 24 V DC	Can be selected using the DIL switch	
	Current-carrying capacity [A]	0.5	2x 0.25
	Watchdog function	Active after 50 ms	
	Digital inputs	Number	2
Connection technology		M12, 5-pin socket with double allocation	
Sensor supply via AS-interface		Short circuit and overload proof	
Sensor connection		2-wire and 3-wire sensors, light barriers, etc.	
Type		IEC 11 31-2, type 02	
Input circuitry		PNP (positive switching)	
Current-carrying capacity [mA]		Max. 200 per input, max. 200 all inputs	
Logic level [V]		On: 11 ... 30; off: -30 ... 5	
Reference potential		0 V	
Delay time [ms]	Typically 3 (at 24 V DC)		
AS-interface connection	Connection technology	AS-interface flat cable plug (must be ordered separately)	
	Voltage range [V DC]	26.5 ... 31.6, reverse polarity protected	
	Residual ripple [mVss]	20	
	Current consumption [mA]	Max. 12 (basic load of the electronics) <ul style="list-style-type: none"> • plus the current consumption of the digital inputs • plus the current consumption of the outputs if there is no auxiliary power supply Total current consumption of the ASI-EVA: max. 240	
Load voltage connection	Connection technology	AS-interface flat cable plug (must be ordered separately)	
	Nominal voltage [V DC]	24 ±10%	
	Residual ripple [Vss]	4	
	Current consumption [A]	Max. 0.5 (at 24 V)	
	Output voltage [V]	Approx. 1.4 V less than the load or AS-interface voltage	
LED displays	Outputs/inputs	Two each yellow/green	
	ASI-LED	Power/green	
	AUX-PWR-LED	Auxiliary power supply/green	
	FAULT-LED	Fault LED/red	
Diagnostics	Peripherals fault	To specification C.S.2.1, red FAULT-LED	
General data	Protection class (to EN 60529)	IP65 (fully assembled)	
	CE mark	Yes, in accordance with EU Directive 89/336/EEC	
	UL certification	Yes	
	Temperature range [°C]	Operation: -5 ... +50; storage/transport: -20 ... +70	
	Materials	Polyamide	
	Dimensions [mm]	Approx. 102 x 46 x 28.5	
	Weight [g]	200	
AS-interface data	ID code	ID = F _H ; ID1 = F _H ¹ ; ID2 = E _H	
	IO code	B _H	
	Profile	S-B.F.E	
	AS-interface certificate	Yes, certificate no. 43301	

1) Factory setting, set to 0_H by some programming devices (Spec. V2.1) when addressing the slave

AS-interface® components

Individual valve interface ASI-EVA – Input module with 4 inputs

FESTO

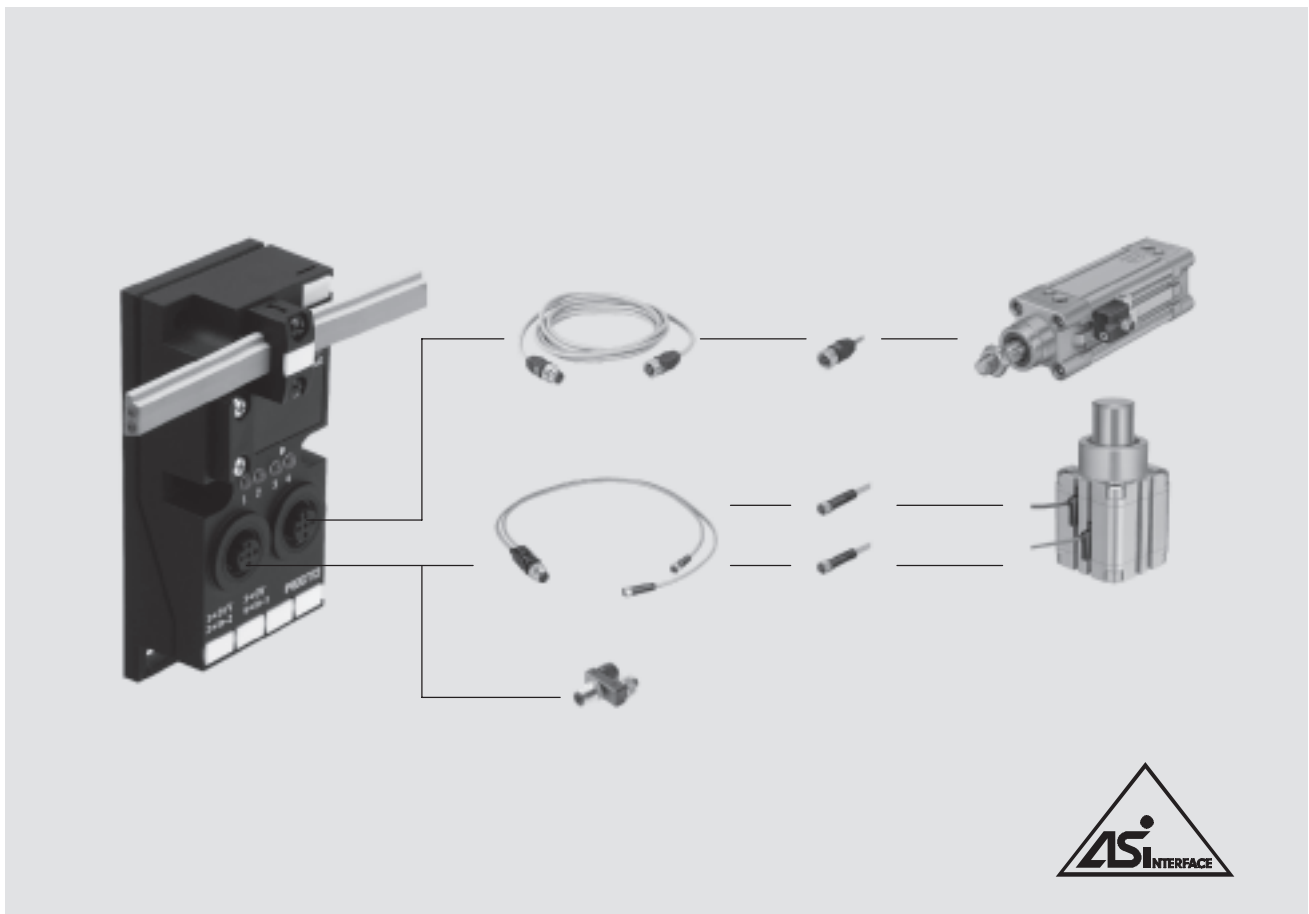

Individual valve interface to Specification V2.1¹⁾ – Input module with 4 inputs

General data

4-fold input module ideal for the connection of additional

- proximity sensors for cylinders
- sensors
- light barriers
- other digital input signals

Suitable for use with valve terminals

- CPA
- CPV
- or as an input module for any desired inputs

The inputs are short circuit proof. Easy to install on the AS-interface. Simply connect to the yellow cable and it's ready to go.

Type

- Inputs based on IEC 1131-2, DC 24 V, PNP
- Up to 200 mA per input
- Two M12 sockets
- Two inputs on each M12 socket
- Suitable for Festo M12 DUO plugs, for the DUO cables M12/2x M8 and the T-type plug connectors M12-2x M12 or M12-2x M8
- Status LEDs for each input
- Fault LED and enhanced diagnostics as per C.S.2.1¹⁾
- Ready-to-connect cable for Festo plug and work™ installation
- Flat cable sockets are available (turned through 180° or standard) and must be ordered separately

Application

Flexible and cost-effective connection of one to four sensors to the AS-interface. Decentralised machine and system structures, for example

- in conveyor technology
- in sorting systems
- in upstream machine functions
- for all types of inputs

1) Slave compatible with SPEC V3.0

AS-interface® components

Individual valve interface ASI-EVA – Input module with 4 inputs

Technical data		
Type	ASI-EVA-4E-M12-5POL	
Digital inputs	No. of digital inputs	4
	Connection technology	M12, 5-pin socket with double allocation
	Sensor supply via AS-interface	Short circuit and overload proof
	Sensor connection	2-wire and 3-wire sensors, light barriers, etc.
	Type	IEC 1131-2, type 02
	Input circuitry [V DC]	24, PNP (positive switching)
	Current-carrying capacity [mA]	Max. 200 per input, max. 200 all inputs
	Logic level [V]	On: 11 ... 30; off: -30 ... 5
	Reference potential [V]	0
	Delay time [ms]	Typically 3 (at 24 V DC)
AS-interface connection	Connection technology	AS-interface flat cable plug (must be ordered separately)
	Voltage range [V DC]	26.5 ... 31.6, reverse polarity protected
	Residual ripple [mVss]	20
	Current consumption [mA]	Max. 12 (basic load of the electronics) <ul style="list-style-type: none"> plus the current consumption of the digital inputs Total current consumption of the ASI-EVA: max. 240
LED displays	Inputs	In/green
	ASI-LED	Power/green
	FAULT-LED	Fault LED/red
Diagnostics	Peripherals fault	As per specification C.S.2.1, additionally red LED
	Protection class (to EN 60529)	IP65 (fully assembled)
	Electromagnetic compatibility	Tested to EN 50295 (low voltage switchgear)
	CE mark	Yes, in accordance with EU Directive 89/336/EEC
	UL certification	Yes
	Temperature range [°C]	Operation: -5 ... +50; storage/transport: -20 ... +70
	Materials	Polyamide
	Dimensions [mm]	Approx. 102 x 46 x 28.5
	Weight [g]	200
AS-interface data	ID code	1 _H
	IO code	0 _H
	Profile	S-0.1
	AS-interface certificate	Yes, certificate no. 43302

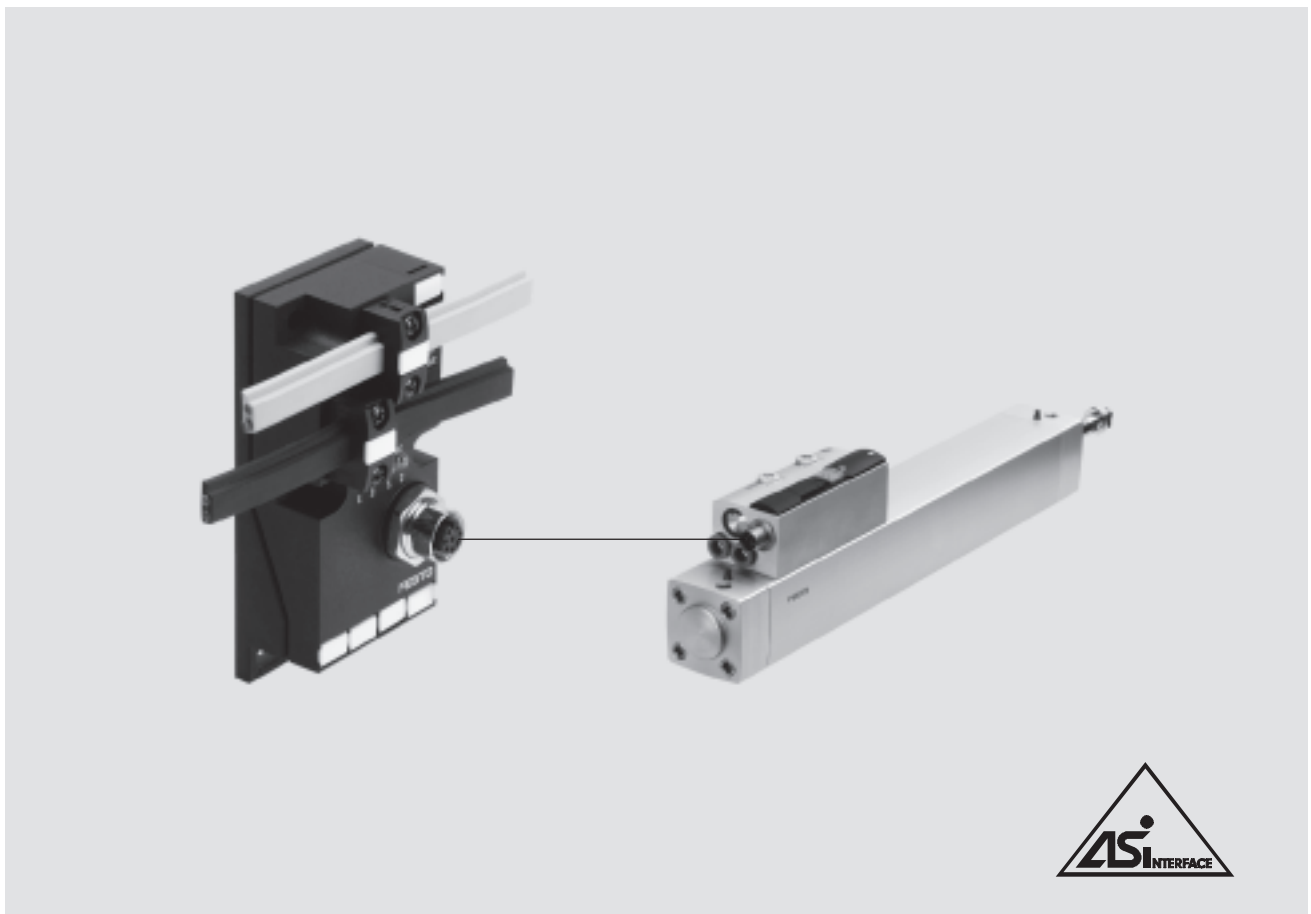

Individual valve interface to Specification V2.1¹⁾ – Interface for DNCV

General data

Special interface module for DNCV. Designed for an integrated cylinder/valve combination with integrated diagnostic module.

The pneumatic drive conforms as near as possible to the international standard DIN/ISO 6431 as well as the further standards VDMA 24 562, NFE 49 003 and UNI 10 290.

Type

Interface for DNCV

- Two inputs and two outputs as well as a diagnostic input on one 8-pin M12 socket
- Inputs based on IEC 1131-2, DC 24 V, PNP
- Up to 200 mA per input
- Status LEDs for each input
- Fault LED and enhanced diagnostics as per C.S.2.1¹⁾

- Optimised design for Festo DNCV with integrated diagnostic module
- Ready-to-connect cable for Festo plug and work™ installation: KM12-8GD8GS-2-PU
- Flat cable sockets are available (turned through 180° or standard) and must be ordered separately

Application

Easy and flexible connection of special cylinders in upstream applications to the AS-interface.

- Valve and cylinder integrated
- Flow control valves integrated
- Limit switch integrated and adjustable
- Single supply of data and power via a flat cable
- Easy diagnostics and servicing thanks to the separation of the drive and interface

1) Slave compatible with SPEC V3.0

AS-interface® components

Individual valve interface ASI-EVA – Interface for DNCV

FESTO

Technical data		
Type	ASI-EVA-2E2A-M12-8POL-Z	
Outputs/valves	No. of outputs/valves	2
	Type	Designed for DNCV (cylinder/valve combination)
	Cable length [m]	2
	Cable type	Round cable 8x 0.25 mm ² ; cable Ø 5.8 mm; polyurethane; colour: grey
	Valve connection	M12 plug, 8-pin, pins 5, 6 and 8
	Valve actuator design	Short circuit and overload proof
	External power supply 24 V DC	Can be selected using the DIL switch
	Current-carrying capacity ¹⁾ [A]	2x 0.25
	Watchdog function	Active after 50 ms
Digital inputs	Number	2
	Connection technology	M12 plug, 8-pin; sensors: pins 2, 3 and 4; diagnostics: pins 1 and 7
	Sensor supply via AS-interface	Short circuit and overload proof
	Sensor connection	Designed for DNCV (with integrated limit switches)
	Type	IEC 1131-2, type 02
	Input circuitry [V DC]	24, PNP (positive switching)
	Current-carrying capacity [mA]	Max. 200 per input, max. 200 all inputs
AS-interface connection	Connection technology	AS-interface flat cable plug (must be ordered separately)
	Voltage range [V DC]	26.5 ... 31.6, reverse polarity protected
	Residual ripple [mVss]	20
	Current consumption [mA]	Of the electronics (basic load): max. 12 <ul style="list-style-type: none"> • DNCV inputs • DNCV valves Total current consumption of the ASI-EVA: max. 240
Load voltage connection	Connection technology	AS-interface flat cable plug (must be ordered separately)
	Nominal voltage [V DC]	24 ±10%
	Residual ripple [Vss]	4
	Current consumption [A]	Max. 0.5 (at 24 V)
	Output voltage [V]	Approx. 1.4 V less than the load or AS-interface voltage
LED displays	Outputs/inputs	Two each yellow/green
	ASI-LED	Power/green
	AUX-PWR-LED	Auxiliary power supply/green
	FAULT-LED	Fault LED/red, also for DNCV diagnostics
Diagnostics	Peripherals fault	To specification C.S.2.1, red FAULT-LED
General data	Protection class (to EN 60529)	IP65 (fully assembled)
	Electromagnetic compatibility	Tested to EN 50295 (low voltage directive)
	CE mark	Yes, in accordance with EU Directive 89/336/EEC
	UL certification	Yes
	Temperature range [°C]	Operation: -5 ... +50; storage/transport: -20 ... +70
	Materials	Polyamide
	Dimensions [mm]	Approx. 102 x 46 x 28.5
Weight [g]	200	
AS-interface data	ID code	ID = F _H ; ID1 = F _H ² ; ID2 = E _H
	IO code	B _H
	Profile	S-B.FE
	AS-interface certificate	Yes, certificate no. 43303
Parameter P3	DNCV diagnostic function	1: enable; 0: disable
	Default	1 for DNCV with diagnostic module ³⁾

1) With an external voltage supply, otherwise the total current consumption is max. 240 mA

2) The diagnostic input must be defined for DNCV without a diagnostic module

3) Factory setting, set to 0_H by some programming devices (Spec. V2.1) when addressing the slave

AS-interface® components

Individual valve interface ASI-EVA – Interface for DNCV

Diagnostics and parameterisation

The AS-i individual valve interface type ASI-EVA-2E2A- M12-8POL-Z supports the evaluation of a diagnostic output from drive/valve combinations, for example cylinder/valve combination DNCV.

Any faults or malfunctions that occur within a drive/valve combination (0 signal at pin7) are indicated as peripherals faults of the slave at the AS-interface master.

Depending on the master, the four parameter bits can be addressed in different formats (binary, hexadecimal).
Parameter bits can also be changed with an addressing device.

The addressing device ASI-PRG-ADR from Festo works with hexadecimal values.
Diagnostics of the individual valve interface can be deactivated via the AS-interface parameter port P3 (binary: P3 = 0, hexadecimal: 7).

Parameter bits (example)				
	P3	P2	P1	P0
Hexadecimal entry	Binary entry			
Fh	1	1	1	1
7	0	1	1	1

Parameter port settings		
Hexadecimal entry	Parameter port P3	Description
Fh	P3 = 1 (diagnostics active, factory setting)	Faults in the slave as well as a 0 signal ¹⁾ at the diagnostic input (pin 7): • will be indicated as peripherals faults
7	P3 = 0 (diagnostics inactive)	Faults in the slave as well as a 0 signal ¹⁾ at the diagnostic input (pin 7): • will not be indicated as peripherals faults

1) 0 signal = Error message from the drive/valve combination or wire break

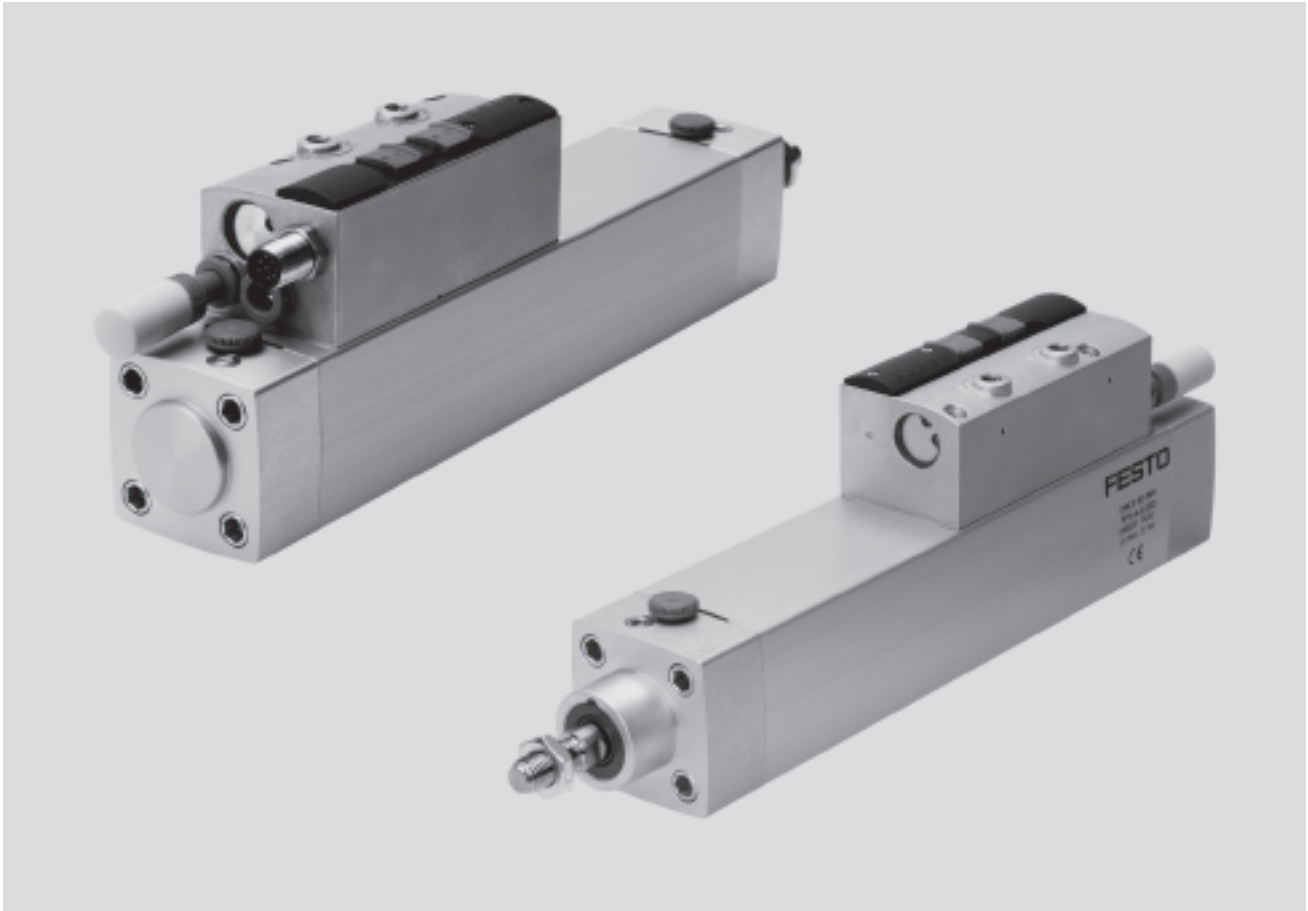

Cylinder/valve combination DNCV

Easy to mount

- Fully assembled and tested drive unit
- Less complicated when ordering, installing and commissioning
- Direct mounting
- Integrated proximity sensors for position sensing
- Integrated exhaust air flow control

Compatible

- Comprehensive range of accessories from the standard cylinder modular system
- Multi-pin connection as interface to PLC, AS-i module ASI-EVA or CPX terminal (various bus protocols)
- Dimensions largely compliant with DIN ISO 6431 and VDMA 24 562

Versatile

- Integrated 5/2-way or 5/3-way valves
- Optional diagnostic module for monitoring of stroke duration and number of strokes

Reliable

- Status displays for piston position and valve actuation
- Rapid response times through direct connection of the valve and drive
- Adjustable pneumatic end-position cushioning
- Manual override

High functionality

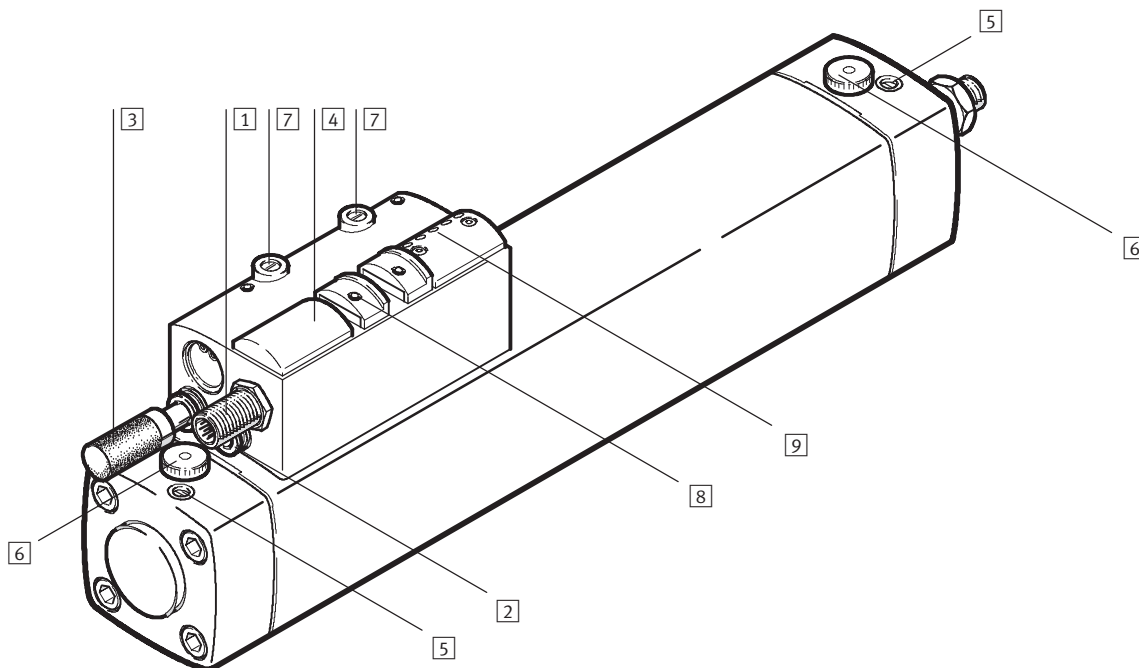

- 1 Multi-pin connection, M12 plug, 8-pin
- 2 Supply port (QS push-in fitting)
- 3 Silencer (QS push-in fitting for exhaust air)
- 4 Valve
- 5 Regulating screw for pneumatic end-position cushioning PPV
- 6 Adjusting knob for fine adjustment of the position of the integrated proximity sensors (removable to prevent inadvertent resetting)
- 7 Regulating screws for stroke speed, separated for forward and return stroke
- 8 Manual override, non-detenting or detenting
- 9 Diagnostic module (optional) with LEDs for displaying the piston position, valve switching status and for diagnostics of stroke duration and number of strokes

Basic diagnostics

Proximity switch monitoring:

Display of the piston position (retracted or advanced end position).

The diagnostic LED lights up in the case of double signalling. The error signal is not output to the controller.

Diagnostic module DNCV-...-D (optional, expandable)

Proximity switch monitoring

In the event of a malfunction or double signalling, apart from the diagnostic LED lighting up, the signal level at the diagnostic output also changes from 24 V to 0 V.

Monitoring of stroke duration

The motion duration for the forward and return stroke is compared with a limit value that is pre-selected using DIP switches. This limit value can be adjusted in increments from 0.1 s to max. 6.3 s. If the limit value is exceeded, the diagnostic LED lights up and the signal level at the diagnostic output changes from 24 V to 0 V.

Monitoring of number of strokes

The number of strokes is compared with a limit value that is pre-selected using DIP switches. This limit value can be adjusted in increments from 10,000 strokes to max. 630,000 strokes. If this limit value is exceeded, the diagnostic LED flashes and the signal level at the diagnostic output changes from 24 V to 0 V. This change in signal level can also be deactivated.

Diagnostic module

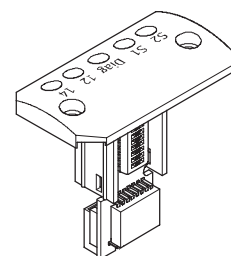

Valve		Valve	
Circuit symbol	Description	Circuit symbol	Description
5/2L 	5/2-way valve, single solenoid with spring return: The valve is normally closed, the piston rod retracts.	5/2LA 	5/2-way valve, single solenoid with spring return: The valve is normally open, the piston rod advances.
5/2J 	5/2-way valve, double solenoid (bistable valve): The valve does not have a defined normal position; instead it requires the electrical actuator or manual override for a defined switching status. The piston rod therefore retracts or advances in accordance with the current valve position.	5/3B 	5/3-way valve, pressurised in mid-position: The piston rod advances when the valve is in the normal position due to the differential piston areas.
5/3E 	5/3-way valve, exhausted in mid-position: In the normal valve position, the piston rod is not subjected to any pressure forces; the piston rod can therefore be moved freely.	5/3G 	5/3-way valve, closed in mid-position: The piston rod is subjected to pressure when the valve is in the normal position and therefore remains in the current position. The piston rod may, however, drift when external forces are present; it is particularly important to be aware of this in the case of vertical cylinder configurations.

Manual override		Manual override	
Function diagram	Description	Function diagram	Description
	Non-detenting actuation: The manual override is activated using a pointed object.		Detenting actuation: The manual override is actuated by moving the slide.

AS-interface® components

Individual valve interface ASI-EVA – Connections/displays

Overview of connections/displays – ASI-EVA

Individual valve interface – 2I2O, 2I1O

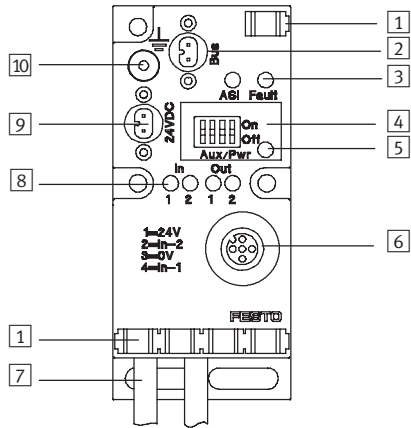

- 1 Inscription labels
- 2 AS-interface bus connection
- 3 ASI-LED (power/green),
FAULT-LED (fault/red)
- 4 DIL switch for load voltage
connection
- 5 AUX-PWR-LED
- 6 Sensor connection
- 7 1 or 2 connecting cables for
outputs (valves)
- 8 LED display for
– Outputs
– Inputs
- 9 Auxiliary power supply for
outputs/valves
- 10 Functional earth connection

Input module with 4 inputs

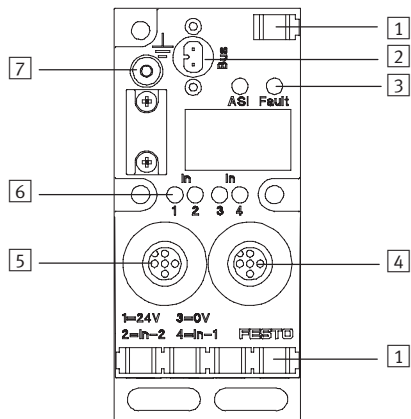

- 1 Inscription labels
- 2 AS-interface bus connection
- 3 ASI-LED (power/green),
FAULT-LED (fault/red)
- 4 Sensor connection 2
(inputs 3 and 4)
- 5 Sensor connection 1
(inputs 1 and 2)
- 6 LED status display for inputs
(In, green)
- 7 Functional earth connection

Interface for DNCV

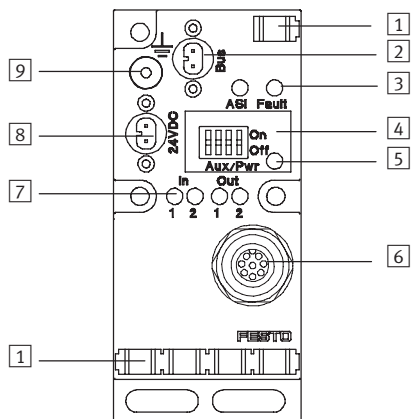

- 1 Inscription labels
- 2 AS-interface bus connection
- 3 ASI-LED (power/green),
FAULT-LED (fault/red)
- 4 DIL switch for load voltage
connection
- 5 AUX-PWR-LED
- 6 DNCV sensor/valve connection
- 7 LED display for
– Valve
– Sensors
- 8 Auxiliary power supply for valve
- 9 Functional earth connection

Pin allocation			
Inputs	X1	X2	LED
ASI-EVA-...-2E-...-A-Z			
	1: 24 V DC	-	IN-2
	2: Input IN-2		IN-1
	3: 0 V		
	4: Input IN-1		
	5: n.c.		
ASI-EVA-...-4E-M12-5POL			
	1: 24 V DC	-	IN-2
	2: Input IN-2		IN-1
	3: 0 V		
	4: Input IN-1		
	5: n.c.		
	-	1: 24 V DC	IN-4
		2: Input IN-4	IN-3
		3: 0 V	
		4: Input IN-3	
		5: n.c.	

Pin allocation		
Inputs/outputs	X1	LED
ASI-EVA-2E2A-M12-8POL-Z		
	1: 24 V DC	
	2: Sensor IN-2	IN-2
	3: Sensor IN-1	IN-1
	4: 0 V sensors	
	5: Coil 14 OUT-2	OUT-2
	6: Coil 12 OUT-1	OUT-1
	7: Diagnostics	
	8: 0 V sensors	

Pin allocation		
AS-i connection		
	1 AS-interface bus 1: + (light blue) 2: - (brown)	2 Auxiliary power supply for 1: 0 V 2: + 24 V DC

Open cable allocation	
For any inputs/outputs	
Black 1/2	24 V DC/0 V
Green/yellow	n.c.

Dimensions – ASI-EVA

Download CAD data → www.festo.com

Input/output module with 2 inputs and 1 or 2 outputs

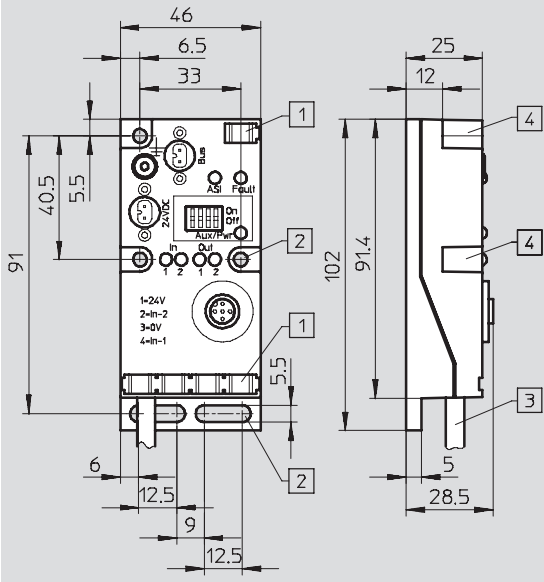

- 1 Mounting option for inscription label
- 2 Mounting hole for surface mounting
- 3 Cable module
- 4 Mounting hole for ITEM profile 40 mm or other mounting option

Input module with 4 inputs

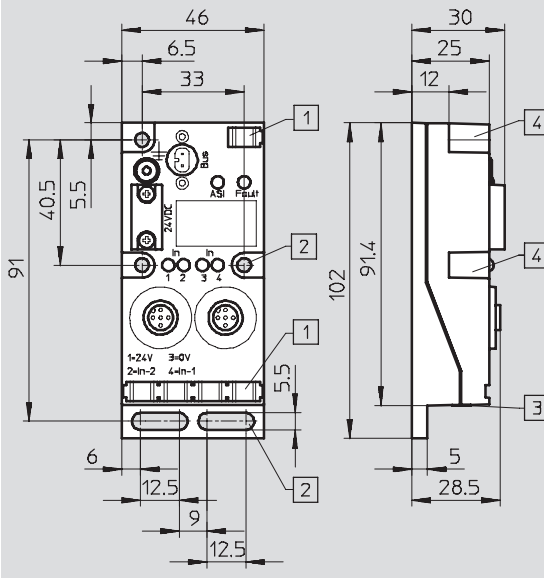

- 1 Mounting option for inscription label
- 2 Mounting hole for surface mounting
- 3 Ring seal
- 4 Mounting hole for ITEM profile 40 mm or other mounting option

Dimensions – ASI-EVA

Download CAD data → www.festo.com

Interface for DNCV

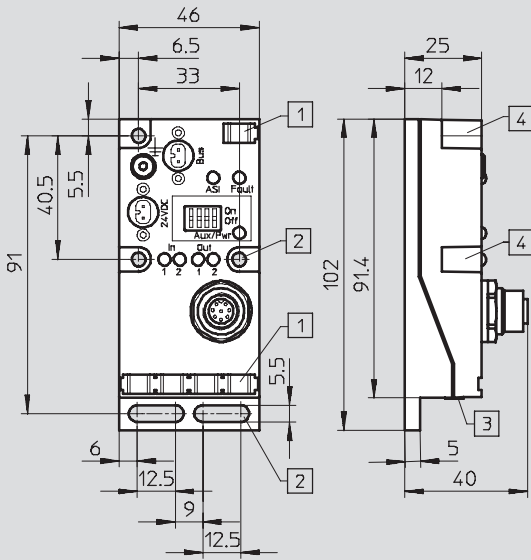

- 1 Mounting option for inscription label
- 2 Mounting hole for surface mounting
- 3 Ring seal
- 4 Mounting hole for ITEM profile 40 mm or other mounting option

Example: H-rail mounting

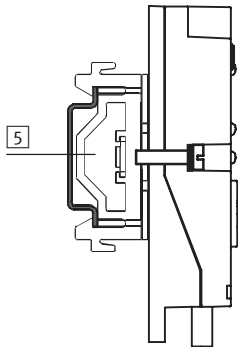

- 5 H-rail mounting on mounting rail EN 60715 35 x 15 using adapter kit CP-TS-HS32

Dimensions – Connecting cable

Download CAD data → www.festo.com

KM12-8GD8GS-2-PU

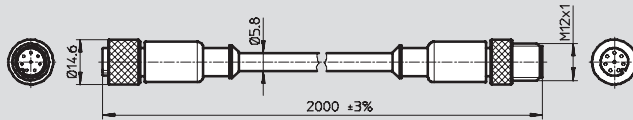

Dimensions – Pin allocation for solenoid coils

Download CAD data → www.festo.com

ASI-EVA-MF-2E...-A-Z

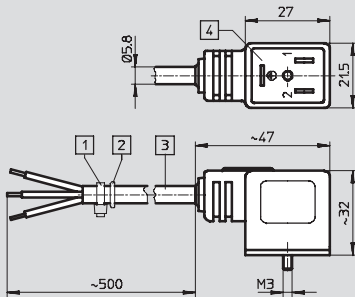

- 1 Cable binder
- 2 O-ring 5x 1.5
- 3 3-wire cable 0.5 m (3x 0.25 mm²)
- 4 Connections for plug to EN 175 301-803 type C

ASI-EVA-MEB-2A...-A-Z

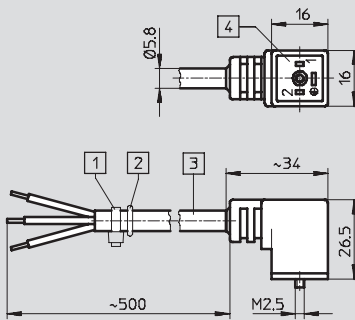





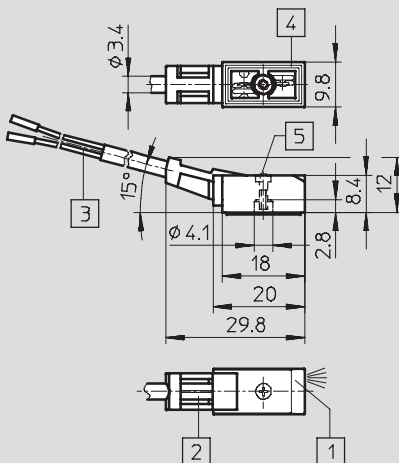



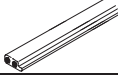





- 1 Cable binder
- 2 O-ring 5x 1.5
- 3 3-wire cable 0.5 m (3x 0.5 mm²)
- 4 Connections for plug to EN 175 301-803 type B



ASI-EVA-MZB9-2E...-A-Z



- 1 LED display
- 2 Holder for inscription labels
- 3 2-wire cable 0.5 m (2x 0.25 mm²)
- 4 Connection pattern for MZC
- 5 Mounting screw M2 x 8, max. tightening torque 0.35 Nm

Ordering data				
	Description		Type	Part No.
Bus connection				
	AS-interface flat cable, yellow	100 m	KASI-1,5-Y-100	18940
	AS-interface flat cable, black	100 m	KASI-1,5-Z-100	18941
	Flat cable socket ¹⁾		ASI-SD-FK	18785
	Flat cable socket ¹⁾	Turned through 180°	ASI-SD-FK180	196089
	Flat cable blanking plug		ASI-SD-FK-BL	196090
	AS-interface flat cable distributor	Parallel cable	ASI-KVT-FK	18786
	AS-interface flat cable distributor	Symmetrical cable	ASI-KVT-FK-S	18797
	Cable cap for flat cable	Scope of delivery 50 pieces	ASI-KK-FK	18787
	Cable sleeve	Scope of delivery 20 pieces	ASI-KT-FK	165593
Sensor plugs				
	Straight sensor plug	M12, 5-pin, PG7	SEA-M12-5GS-PG7	175 487
	Straight sensor plug	M12, 4-pin, PG7	SEA-GS-7	18 666
	Straight sensor plug	M12, PG9 connector	SEA-GS-9	18778
	Straight sensor plug for cable Ø 2.5 mm	M12, 4-pin	SEA-4GS-7-2,5	192008
	Angled sensor plug	M12, 4-pin	SEA-M12-4WD-PG7	185498
	Protective cap	M12	ISK-M12	165592

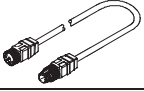
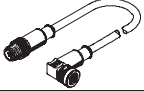
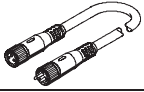
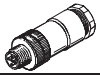
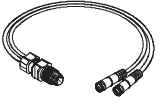
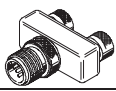
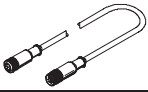
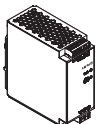
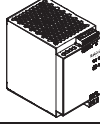
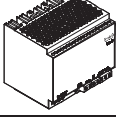

1) Two flat cable connections per ASI-EVA must be connected or covered

Ordering data				
	Description		Type	Part No.
Connecting cables				
	Connecting cable, straight plug, straight socket	M12, 4-pin/5-pin, 0.2 m	NEBU-M12G5-F-0.2-M12G4	542129
		M12, 4-pin, 2.5 m	KM12-M12-GSGD-2,5	18684
		M12, 4-pin, 5.0 m	KM12-M12-GSGD-5	18686
	Connecting cable, straight plug, angled socket	M12, 4-pin, 1.0 m	KM12 M12-GSWD-1-4	185499
	Modular system for connecting cables → Internet: nebu		NEBU-...	-
DUO plug				
	Plug M12 for 2 sensor cables	4-pin, PG11	SEA-GS-11-DUO	18779
		5-pin, PG11	SEA-5GS-11-DUO	19 010
DUO cable M12 on 2x M8				
	DUO cable M12 4-pin via 2xM8, 3-pin	2x straight socket	KM12-DUO-M8-GDGD	18685
		2x straight/angled socket	KM12-DUO-M8-GDWD	18688
		2x angled socket	KM12-DUO-M8-WDWD	18687
T-type plug connector				
	T-type plug connector		NEDU-M8D3-M12T4	541597
			NEDU-M12D5-M12T4	541596
Connecting cable for DNCV				
	Connecting cable	M12, 8-pin	KM12-8GD8GS-2-PU	525617
Miscellaneous				
	Primary switched mode modular power supply AS-i power supply 4.8 A		SVG-1/230VAC-ASI-5A	547 869
	Primary switched mode modular power supply 24 VDC power supply 5 A		SVG-1/230-24VDC-5A	547 867
	Primary switched mode modular power supply 24 VDC power supply 10 A		SVG-1/230-24VDC-10A	547 868
	Addressing device		ASI-PRG-ADR	18959
	Addressing cable		KASI-ADR	18960

AS-interface® components

Individual valve interface ASI-EVA – Accessories

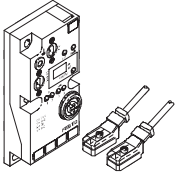
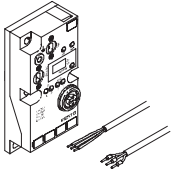
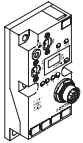
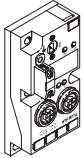
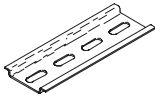
FESTO

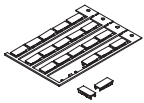
Ordering data			
	Description	Type	Part No.
ASI-EVA I/O modules			
	Valve interface, pre-assembled cable, 2 inputs, 1 output	ASI-EVA-MF-2E1A-Z	196081
	Valve interface, pre-assembled cable, 2 inputs, 2 outputs	ASI-EVA-MF-2E2A-Z	196082
	Valve interface, pre-assembled cable, 2 inputs, 1 output	ASI-EVA-MEB-2E1A-Z	196085
	Valve interface, pre-assembled cable, 2 inputs, 2 outputs	ASI-EVA-MEB-2E2A-Z	196086
	Valve interface, pre-assembled cable, 2 inputs, 1 output	ASI-EVA-MZB9F-2E1A-Z	196083
	Valve interface, pre-assembled cable, 2 inputs, 2 outputs	ASI-EVA-MZB9F-2E2A-Z	196084
	Valve interface with open cable ends, 2 inputs, 1 output	ASI-EVA-K1-2E1A-Z	196087
	Valve interface with open cable ends, 2 inputs, 2 outputs	ASI-EVA-K1-2E2A-Z	196088
	AS-i module, 2 inputs, 2 outputs	ASI-EVA-2E2A-M12-8Pol-Z	197070
	AS-i module, 4 inputs	ASI-EVA-4E-M12-5POL	197069
Mounting			
	H-rail to EN 60715	NRH-35-2000	35 430
	Mounting for H-rail	CP-TS-HS35	170 169
Inscription labels			
	Inscription labels 6x10 mm in frames (64 pieces)	IBS-6x10	18 576

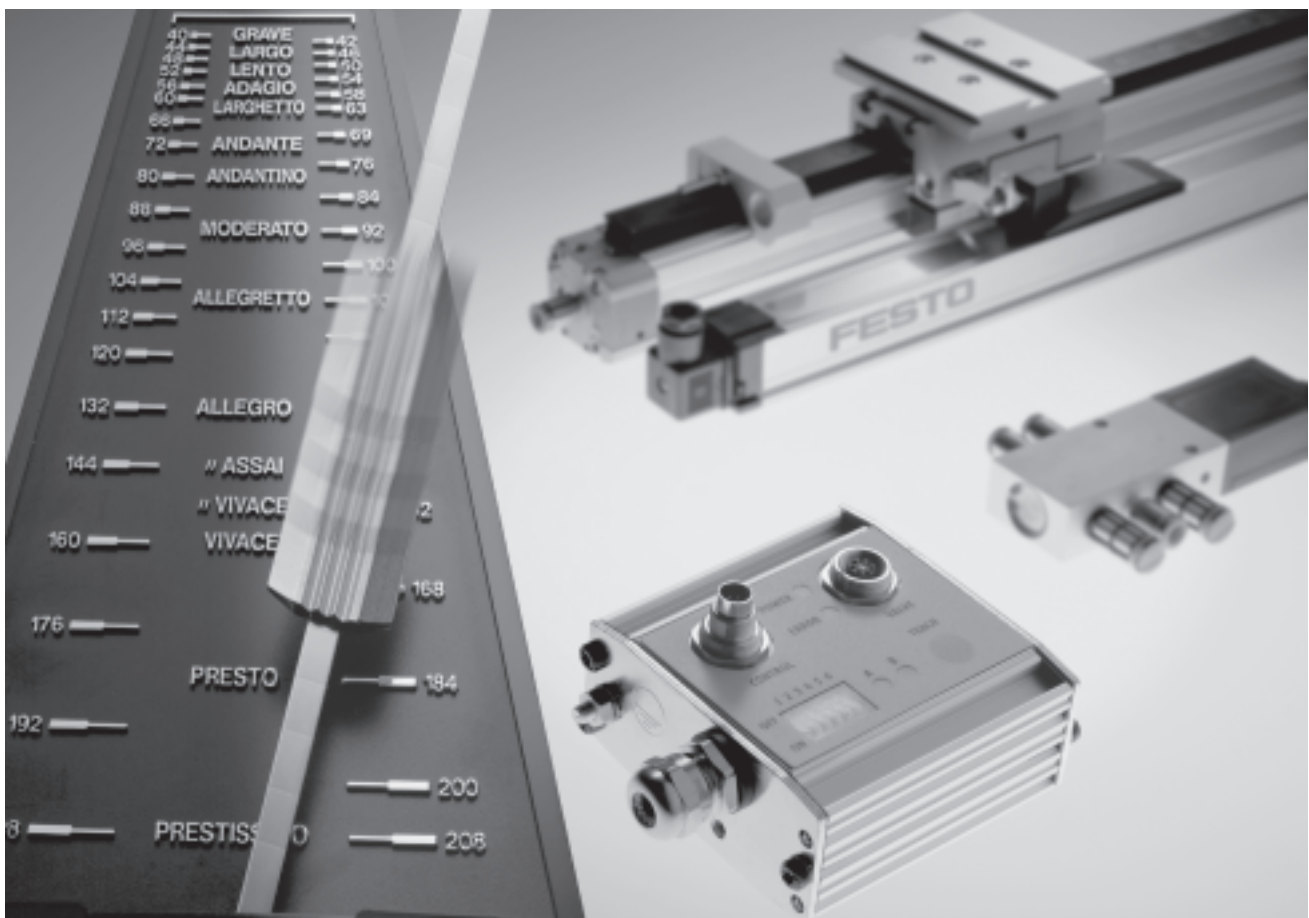

Applications – Innovative, high-performance and precision-pulsed drive packages

- Drives on the AS-interface
- Intelligent valve/cylinder combinations with integrated diagnostics DNCV
- Process actuators such as linear valve actuators and quarter turn actuators with robust local controller or sensor box on the AS-interface

DNCV

Intelligent drives combine numerous functions in one unit:

- Standard cylinder DNC with a smooth and easy to clean housing surface

- Integrated 5/2-way or 5/3-way valve
- Two integrated flow control valves with speed control
- Integrated proximity sensors
- Integrated diagnostic module for preventative maintenance (optional) → 100

DLP and DAPZ for Copac/Copar

Simple, fast installation is preferred in decentralised applications in the process industry and in water treatment systems.

The local controller DLP connects linear valve actuators and quarter turn actuators to the AS-interface. The sensor box DAPZ converts mechanical end positions from pneumatic actuators into electrical signals and also provides connections for the solenoid valve.

Advantages:

- Namur interface (DIN 19 234)
- Quick and easy assembly and connection
- Integrated solenoid valve actuation
- Fully assembled and tested unit for the AS-interface

-  - Note
Detailed description
→ Internet: dlp

Automatic local controller – DLP-VSE-...-ASI

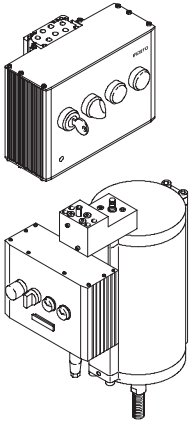

General data

- Integrated 5/3-way valve, normally closed, pressure range 2 ... 8 bar
- Integrated LED displays (open/closed)
- Key actuator for selecting the operating mode:
 - Remote control via AS-interface
 - On-site operation
 - Switched off
- The local controller VSE has been optimised for DLP/Copac but can also be used for DRD/Copar

Application

The combination DLP/Copac and local controller VSE offers the following advantages:

- Clear construction
- Process reliability
- Suitable for exterior use, temperature range –5 ... +50 °C
- Remote control or on-site operation
- Remote diagnostics and LED displays on-site
- No need for control cabinet on-site
- No further assembly

Select the suitable pneumatic drive for your application:

- For linear valve actuators: DLP/Copac
- For quarter turn actuators: DRD/Copar

Order the actuator ready for installation:

- With local controller DLP-VSE-ASI
- Connect these units with AS-interface – Festo plug and work™

Control by sensor box – DAPZ

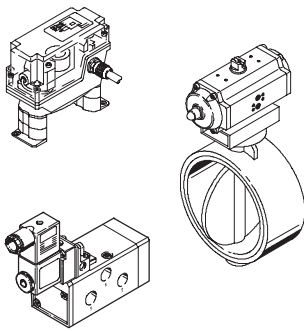

- Standard valve with Namur interface
- Sensor box with integrated valve actuator (solenoid coil plug) and limit switches for converting mechanical end-position signals into electrical signals
- Connect to the AS-interface using the yellow cable

- Pre-assembled and tested unit
- Quick and easy installation
- Festo plug and work™ on the AS-interface
- Suitable for exterior use. Temperature range: –25 ... +85 °C

Alternative ways of connecting process actuators to the AS-interface

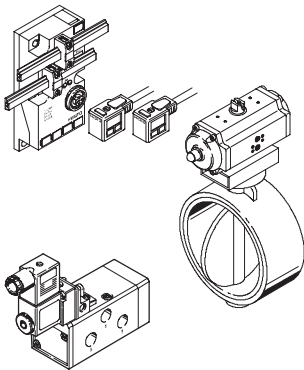

- Standard valve with Namur interface
- Individual valve interface ASI-EVA
- Copac/Copar process actuator
- Discrete sensor configuration

Local controllers DLP-VSE – Technical data

This local controller is a convenient manual unit for controlling process actuators. Using a local controller, a pneumatic drive can assume the functionality of an electrical drive.

- Can be mounted directly on the actuator or on a wall
- Emergency compressed air connection
- Safe thanks to its key-operated switch with removable key
- Large, long-life fluorescent display for the open/closed position of the process valve
- Operated on site or remote-controlled



General technical data

Operating pressure	[bar]	3 ... 8
Voltage supply without AS-interface	[V DC]	24 -15/+20%
Residual ripple	[Vmss]	4
Current consumption (at 24 V)	[mA]	140
Voltage supply with AS-interface	[V DC]	26.5 ... 31.6
Residual ripple	[Vmss]	≤20
Auxiliary voltage supply with AS-interface	[V DC]	24 -15/+20%
AS-interface profile		ID code = F _H ; IO code = 7 _H S-7.F
Operating voltage at the valve	[V DC]	24 -15/+20%
Duty cycle of solenoid coils	[%]	100
Protection class		IP65 Plug connector when fully pushed in, or fitted with protective cap
Vibration (to IEC68, Transport DIN/EN 60068)		3.5 mm travel at 2 ... 9 Hz 1 g acceleration at 9 ... 200 Hz
Operation		0.35 mm travel at 10 ... 60 Hz 5 g acceleration at 60 ... 150 Hz
Protection against electric shock (protection against direct and indirect contact to EN 60204-1 / ICE 204)		Via connection to a PELV (Protected Extra-Low Voltage) power supply unit
Electromagnetic compatibility		
Interference emission	– Tested to EN 55011 – Tested to EN 61000-6-4	Limit value class A
Interference immunity	– Tested to EN 61000-4-2...6 – Tested to EN 61000-6-2	Passed

Ambient conditions

Ambient temperature	[°C]	-5 ... +50 Based on EN 60654-1 class C1 (use in weather-protected areas)
Optional ambient temperature	[°C]	-25 ... +55 To EN 60654-1 class C2 (use in weather-protected areas)
Storage temperature	[°C]	-40 ... +80
Relative air humidity	[%]	5 ... 100 condensing
Corrosion resistance class CRC ¹⁾		3

1) Corrosion resistance class 3 as per Festo standard 940 070
Components requiring higher corrosion resistance. External visible parts in direct contact with industrial atmospheres or media such as solvents and cleaning agents, with a predominantly functional requirement for the surface.

Ordering data		Brief description	Type	Part No.
Local controller DLP-VSE				
	Integrated 5/3-way valve, normally closed, fieldbus connection for AS-interface		DLP-VSE-3-5/3-G-ASI	188 473
Mounting				
	Mounting kit for wall mounting in conjunction with the connecting plate DLP-VSE-OBEN		DLP-VSE-BP	192 062
	Connecting plate in conjunction with mounting kit DLP-VSE-BP for tubing connection in the direction of the drive		DLP-VSE-OBEN	192 061
	Connecting plate for mounting on the linear drive DLP		DLP-VSE-OBEN-NAMUR	192 060
Fieldbus connection				
	Cable socket for AS-interface		ASI-SD-FK	18 785
	Cable socket for AS-interface, profile turned 180°		ASI-SD-FK180	196 089
Fittings				
	Push-in fitting, male thread with internal hexagon		QS-1/8-8-1	153 015
	Barbed fitting, high-alloy stainless steel with sealing ring		CRCN-M5-PK-3	13 967
	Barbed fitting, high-alloy stainless steel with sealing ring		CRCN-1/8-PK-4	13 970
	Quick connector, aluminium design with sealing ring for plastic tubing PL, PP, PU (scope of delivery 10 pieces)		CK-M5-PK-3	3 561
	Quick connector, plastic design with moulded-on sealing ring for plastic tubing PL, PP, PU (scope of delivery 10 pieces)		CK-1/8-PK-6	2 028
Silencers				
	Sintered bronze (scope of delivery 10 pieces)		U-M5	4 645
	Polymer		U-1/8	2 307

Local controllers DLP-VSE – Display and operation

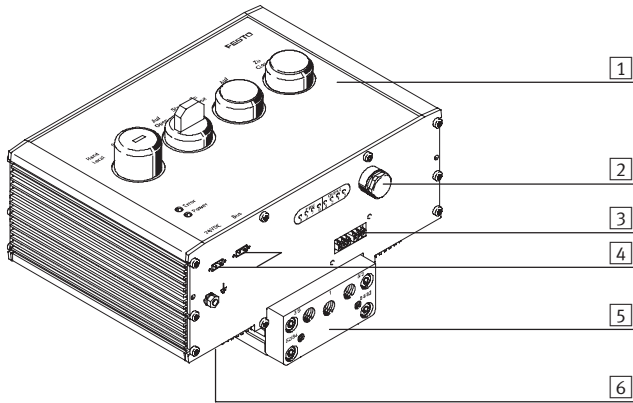

- 1 Display and control panel
- 2 Pressure equalisation component
- 3 Electrical connection
- 4 AS-interface connection
- 5 Housing block with integrated air duct
- 6 Integrated pneumatic valve (not shown)

Electrical connections and bus interface

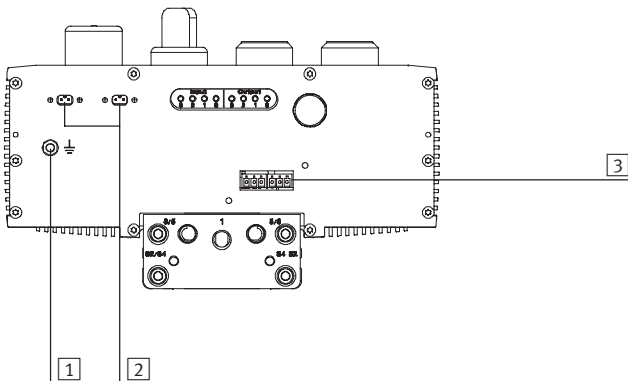

- 1 Earth terminal
- 2 AS-interface connection
- 3 Limit switch inputs

Recommendation

Use the Festo addressing device ASI-PRG-ADR, Part No. 18 959, with addressing cable KASI-ADR, Part No. 18 960 (or Siemens PSG).

Before connecting an AS-interface slave to the bus, allocate each AS-interface slave a free AS-interface address. Set the address

you require using the AS-interface addressing device. Permissible operating range: 1 ... 31.

Remarks

ID code = F_H
IO code = 7_H (see rating plate)
Parameterisation of the AS-interface slave is not necessary.

Connect limit switches (PNP inputs)

The inputs are short circuit proof. The slave is switched off if a short circuit occurs. The AS-interface master then

identifies this slave as absent. The slave reports back as functioning once the short circuit has been eliminated.



Note

Use the Festo cable sockets ASI-SD-FK, Part No. 18 785, or ASI-SD-FK180, Part No. 196 089

to connect the local controller, enabling you to achieve IP65 protection.

Local controllers DLP-VSE – Installation of the AS-interface

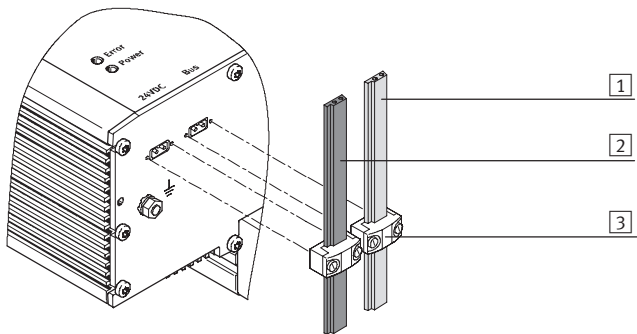

- 1 Flat cable, yellow
- 2 Flat cable, black
- 3 Cable socket

Note

The power for the inputs is supplied via the AS-interface bus. The local controller must always be separately supplied with 24 V via the load voltage connection (black flat cable). The AS-interface features an integrated watchdog function which resets the outputs if communication with the bus fails.

Commissioning at the AS-interface – Allocation of the data bits

Bit allocation for AS-interface inputs		
Data bit	Input	Meaning
D0	Input 0	Key actuator set to HAND/LOCAL
D1	Input 1	Key actuator set to AUTO/REMOTE
D2	Input 2	Limit switch signal "open"
D3	Input 3	Limit switch signal "closed"

Bit allocation for AS-interface outputs		
Data bit	Output	Meaning
D0	Output 0	Open process valve
D1	Output 1	Close process valve
D2	Output 2	Indicator light "OPEN"
D3	Output 3	Indicator light "CLOSE"

Diagnostics with AS-interface

The user interface has two LEDs (POWER and BUS) from which you can read diagnostic messages for the local controller.

POWER-LED (green)	ERROR-LED (red)	Meaning
on	off	AS-interface voltage present, no fault
off	off	No AS-interface voltage present at the bus
flashing	on	AS-interface address not set (= 0)
on	flashing	Short circuit/overload at the inputs
on	on	Bus communication failure (watchdog expired)



Innovative

- Integrated AS-interface
- Integrated solenoid valve actuator
- Integrated sensor for mechanical end positions
- Quick and easy connection technology
- “Open” and “Closed” display can be individually set via trip cam
- Trip cam gearing prevents position drift

Reliable

- Pre-assembled and tested unit
- High temperature range –25 ... +85 °C
- Robust materials made from impact resistant Vestamid
- Standardised interfaces to the quarter turn actuators
- LED displays for on-the-spot diagnostics
- AS-interface as secure transmission protocol

Easy to mount

- Can be mounted directly on the quarter turn actuators (Copar DRD, Sypar DAPS)
- Fully assembled and tested unit
- Lower cost of selection, ordering, installation and commissioning
- Can be integrated into existing AS-interface networks at any time
- Geometrically coded flat cable ensures polarity-safe connection to the AS-interface
- Easy adjustment of switching points
- Particularly economical thanks to simplified assembly and commissioning

AS-interface® components

Sensor box as intelligent signal generator – Overview

FESTO

General function

- **Integrated inputs:**
The sensor box converts the mechanical end-position signals from pneumatic actuators into electrical signals and provides them as input signals for the AS-interface.
- **Solenoid valve actuation:**
A solenoid valve can be actuated using one output (24 V DC, 2.6 watts). The output is fitted with a pre-assembled cable for the plug pattern MF (industrial standard to DIN 43 650) – another example of Festo plug and work™.
- **Networking concepts:**
Modern systems and processes communicate using networks. Data from the actuator/sensor level is recorded, compressed and transmitted via the AS-interface flexibly and cost-effectively, and can even be forwarded to higher-order fieldbus systems.
- **Proven components:**
Inside the sensor box are components from leading manufacturers. The advantages lie in the tailored combination and the holistic solution.

Connection to the AS-interface

The yellow flat cable of the AS-interface carries the supply for the electronics, the sensors and the output. The flat cable connection is coded to protect against incorrect polarity.

The sensor box is uniquely described by the ID code F_H and the IO code D_H .
Structure of the IO code D_H

D3	D2	D1	D0
E	E	E	A

Sensor 1 “Open” is fed back to data bit D2, sensor 2 “Closed” to data bit D3 (example for drives with clockwise rotation). D1 is not used.

Data bit D0 sets the output and switches the connected solenoid valve.

AS-interface® components

Sensor box as intelligent signal generator – Overview

FESTO

Technical data			
Type		DAPZ-SB-I-30DC-DSAM-RO	
Signal generator	Type	Double initiator with normally-closed function to NAMUR (DIN 19234)	
	Manufacturer	Pepperl & Fuchs	
	Type	NCN3-25F-N4	
	Switching accuracy	Less than 0.5°	
	Service life	Minimum service life of switch: 2x 10 ⁵ cycles	
	Short circuit proof	Yes	
Interface to the drive		NAMUR standard VDI/VDE 3845	
Output	Connection technology	Solenoid plug	
	Nominal voltage [V DC]	24	
	Tolerance	+10/-15 %	
	Residual ripple	As per AS-interface specification, dependent on power supply unit	
	Current consumption [mA]	Max. 120	
	Short circuit proof	Protected by current limitation	
	Connecting cable	PVC cable, solenoid plug already connected	
	Cable length [cm]	30	
	Cable type	3x 0.5 mm ²	
	Valve connection	F coil to DIN 43650, type: industrial standard	
Watchdog function	None		
Supply voltage		Electronics, sensors and output are supplied via the yellow flat cable at the AS-interface connection	
AS-interface connection	Connection technology	AS-interface flat cable plug (included in scope of delivery)	
	Voltage range [V DC]	26.5 ... 31.6, reverse polarity protected	
	Residual ripple [mVss]	20	
	Current consumption [mA]	Max. 12, electronics <ul style="list-style-type: none"> • plus 2-wire sensor 4 • plus connected output (dependent on solenoid valve, max. 120) 	
LED displays	Output	None, illuminating seal possible on solenoid coil (on request)	
	Inputs	2x yellow	
	ASI-LED	Green	
General data	Protection class (to EN 60529)	Sensor IP67, housing IP65	
	Electromagnetic compatibility	AS-interface electronics and initiator: EN 60947-5-2; NE21	
	CE mark	Yes	
	Temperature range [°C]	Operation: -25 ... +85	
	Materials	<ul style="list-style-type: none"> • Seal: Ethylene propylene rubber • Housing socket: Polyamide, black • Housing cover: Transparent polycarbonate (black polyamide or nickel-plated aluminium on request) • Control shaft: Polyacetal • Universal console: Polyamide 	
	Corrosion resistance class CRC ¹⁾	3	
	Dimensions [mm]	Approx. 146 x 64 x 74 (without console)	
	Weight [g]	450	
	AS-interface data	ID code	F _H
		IO code	D _H
Profile		S-D.F	

1) Corrosion resistance class 3 as per Festo standard 940 070
 Components requiring higher corrosion resistance. External visible parts in direct contact with industrial atmospheres or media such as solvents and cleaning agents, with a predominantly functional requirement for the surface.

AS-interface® components

Sensor box as intelligent signal generator – Overview

Dimensions

Download CAD data → www.festo.com

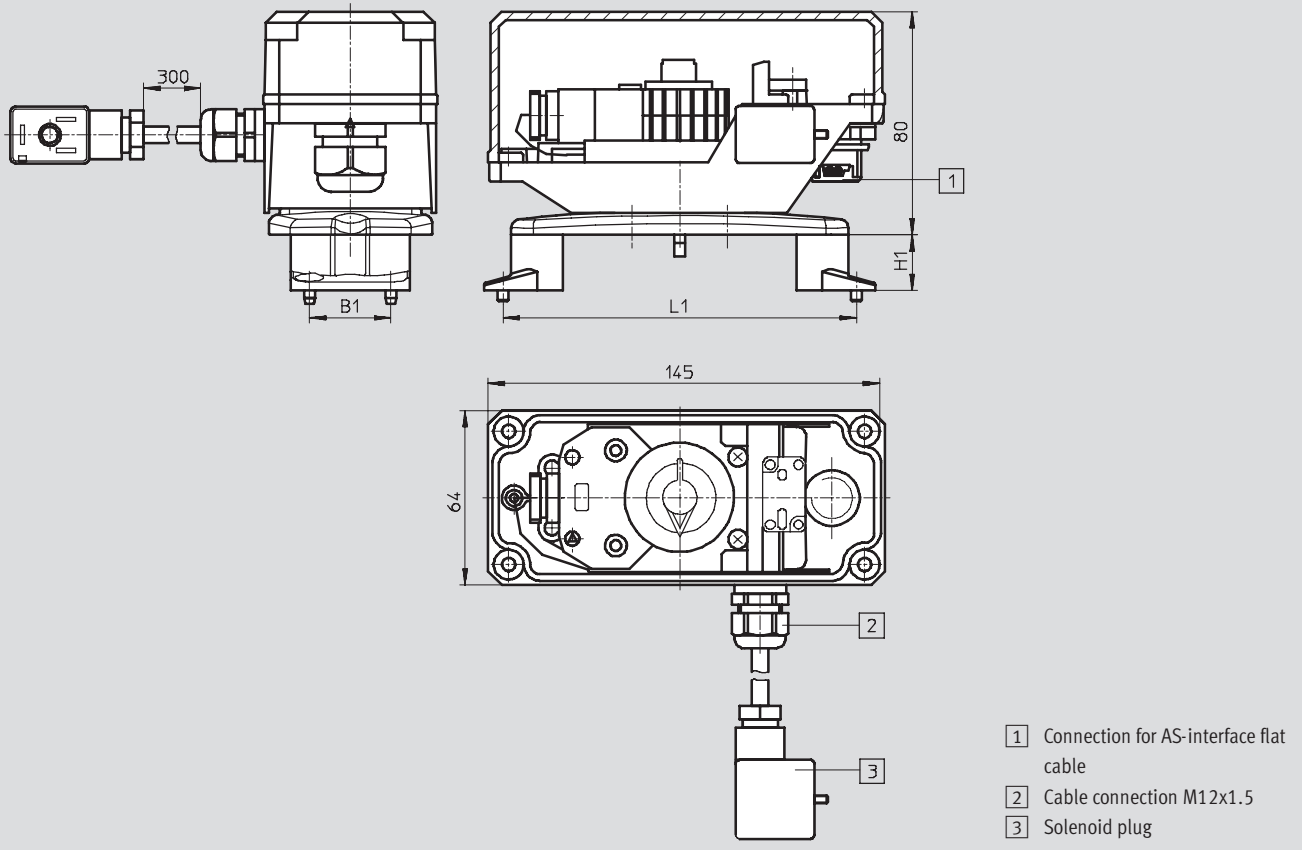

- 1 Connection for AS-interface flat cable
- 2 Cable connection M12x1.5
- 3 Solenoid plug







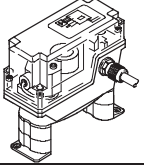
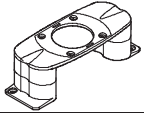
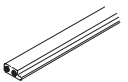

Feet mounted inwards			
	B1	L1	H1
Foot 20	30	80	20
Foot 30	30	80	30

Feet mounted outwards			
	B1	L1	H1
Foot 20	30	130	20
Foot 30	30	130	30

AS-interface® components

Sensor box as intelligent signal generator – Overview

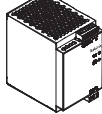
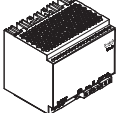
FESTO

Ordering data				
	Description		Type	Part No.
DAPZ... Sensor box				
	Limit switch attachment with integrated valve actuation		DAPZ-SB-I-30DC-DSAM-RO	534473
DAPZ... mounting				
	Mounting console	50x25 / WH 20 mm	DAPZ-SBZ-F50-RO	534477
		130x30 / WH 30 mm	DAPZ-SBZ-K0-RO	534478
		130x30 / WH 30 mm	DAPZ-SBZ-K3-RO	534479
Bus connection				
	AS-interface flat cable, yellow	100 m	KASI-1,5-Y-100	18940
	AS-interface flat cable distributor	Parallel cable	ASI-KVT-FK	18786
	Symmetrical cable	Symmetrical cable	ASI-KVT-FK-S	18797
	Cable cap for flat cable (scope of delivery 50 pieces)		ASI-KK-FK	18787
	Cable sleeve (scope of delivery 20 pieces)		ASI-KT-FK	165593
Miscellaneous				
	Primary switched mode modular power supply AS-i power supply 4.8 A		SVG-1/230VAC-ASI-5A	547869
	Primary switched mode modular power supply 24 VDC power supply 5 A		SVG-1/230-24VDC-5A	547867
	Primary switched mode modular power supply 24 VDC power supply 10 A		SVG-1/230-24VDC-10A	547868
	Addressing device		ASI-PRG-ADR	18959
	Addressing cable		KASI-ADR	18960

AS-interface – Accessories							
Description	Type	CPV-ASI	CPA-ASI	MPA-ASI	ASI-EVA	ASI-EA	VTSA/ VTSA-F
Bus connection							
AS-interface flat cable, yellow, 100 m	KASI-1,5-Y-100	■	■	■	■	■	■
AS-interface flat cable, black, 100 m	KASI-1,5-Z-100	■	■	■	■	■	■
Flat cable socket ¹⁾	ASI-SD-FK	■	■	■	■	-	■
Flat cable socket, turned through 180° ¹⁾	ASI-SD-FK180	■	-	-	■	-	-
Flat cable blanking plug ¹⁾	ASI-SD-FK-BL	■	-	-	■	-	-
AS-interface flat cable distributor, parallel cable	ASI-KVT-FK	■	■	■	■	-	■
AS-interface flat cable distributor, symmetrical cable	ASI-KVT-FK-S	■	■	■	■	-	■
Cable distributor (yellow and black) to 2x M12, 4-pin	ASI-KVT-FKx2-M12	-	■	■	-	■	■
Cable cap for flat cable (scope of delivery 50 pieces)	ASI-KK-FK	■	■	■	■	■	■
Cable sleeve (scope of delivery 20 pieces)	ASI-KT-FK	■	■	■	■	■	■
M12 socket for flat cable	ASI-SD-FK-M12	-	■	■	-	■	■
M12 socket for flat cable, with PG13.5	ASI-SD-PG-M12	-	■	■	-	■	■
M12 socket for round cable, with PG9	FBSD-GD-9-5POL	-	■	■	-	■	■
Sensor plugs							
Straight sensor plug, M12, 5-pin, PG7	SEA-M12-5GS-PG7	-	■	■	■	■	■
Straight sensor plug, M12, 4-pin, PG7	SEA-GS-7	-	■	■	■	■	■
Straight sensor plug, M12, PG9	SEA-GS-9	-	■	■	■	■	-
Angled sensor plug, M12, 4-pin	SEA-M12-4WD-PG7	-	-	-	■	■	-
Sensor plug, 4-pin, M12 for 2.5 mm cable Ø	SEA-4GS-7-2,5	-	■	■	■	■	■
Straight sensor plug, M8, screw-in, 3-pin	SEA-3GS-M8-S	■	■	■	-	■	■
Straight sensor plug, M8, solderable, 3-pin	SEA-GS-M8	■	■	■	-	■	■
Quick connection sensor plug, 4-pin	SEA-GS-HAR-4POL	-	■	■	-	-	■
Sub-D plug, 25-pin	SD-SUB-D-ST25	-	■	■	-	-	■
Protective cap M12	ISK-M12	-	■	■	■	■	■
Protective cap M8	ISK-M8	■	■	■	-	■	■
DUO plug							
DUO plug M12, for 2 cables, 5-pin	SEA-5GS-11-DUO	-	■	■	■	■	■
DUO plug M12, for 2 cables, 4-pin	SEA-GS-11-DUO	-	■	■	■	■	■
T-type plug connector							
M12, 5-pin	NEDU-M12D5-M12T4	-	■	■	■	■	■
M8, 3-pin to M12, 4-pin	NEDU-M8D3-M12T4	-	■	■	■	■	■
T-adapter for DH-485, M12 5-pin	FB-TA-M12-5POL	-	-	-	-	■	-

1) Two flat cable connections per ASI-EVA must be connected or covered

AS-interface – Product range overview							
Description	Type	CPV-ASI	CPA-ASI	MPA-ASI	ASI-EVA	ASI-EA	VTSA/ VTSA-F
Connecting cables							
Modular system for connecting cables	NEBU-...	■	■	■	■	■	■
For AS-interface, 5-pin M12 to 4-pin M12	NEBU-M12G5-F-0.2-M12G4	-	■	■	■	■	
Straight plug M12, 5-pin angled socket type B for F coil, 0.5 m	NEBV-B2W3P-F-0,5-M12G5	-	-	-	-	■	-
Straight plug M12, 5-pin angled socket type B for F coil, 2.5 m	NEBV-B2W3P-F-2,5-M12G5	-	-	-	-	■	-
Straight plug M12, 5-pin angled socket type C for EB coil, 0.5 m	NEBV-C1W3P-F-0,5-M12G5	-	-	-	-	■	-
Straight plug M12, 5-pin angled socket type C for EB coil, 2.5 m	NEBV-C1W3P-F-2,5-M12G5	-	-	-	-	■	-
Straight plug M12, 5-pin angled socket type KMYZ-9 for ZC coil, 0.5 m	NEBV-Z2W2P-0,5-M12G5	-	-	-	-	■	-
Straight plug M12, 5-pin angled socket type KMYZ-9 for ZC coil, 2.5m	NEBV-Z2W2P-2,5-M12G5	-	-	-	-	■	-
Straight plug, angled socket M12 4-pin, 1 m	KM12-M12-GSWD-1-4	-	■	■	■	■	■
Straight plug, straight socket M12 4-pin, 2.5 m	KM12-M12-GSGD-2,5	-	■	■	■	■	■
Straight plug, straight socket M12 4-pin, 5 m	KM12-M12-GSGD-5	-	■	■	■	■	■
Straight plug, straight socket M8, 3-pin, 0.5 m	KM8-M8-GSGD-0,5	■	■	■	-	■	■
Straight plug, straight socket M8, 3-pin, 1.0 m	KM8-M8-GSGD-1	■	■	■	-	■	■
Straight plug, straight socket M8, 3-pin, 2.5 m	KM8-M8-GSGD-2,5	■	■	■	-	■	■
Straight plug, straight socket M8 3-pin, 5 m	KM8-M8-GSGD-5	■	■	■	-	■	■
Straight plug, straight socket M12, 8-pin for DNCV	KM12-8GD8GS-2-PU	-	-	-	■	-	-
DUO cable M12 on 2x M8 for 2x straight socket	KM12-DUO-M8-GDGD	-	■	■	■	■	■
DUO cable M12 on 2x M8 for 2x straight/angled socket	KM12-DUO-M8-GDWD	-	■	■	■	■	■
DUO cable M12 on 2x M8 for 2x angled socket	KM12-DUO-M8-WDWD	-	■	■	■	■	■

AS-interface – Product range overview							
Description	Type	CPV-ASI	CPA-ASI	MPA-ASI	ASI-EVA	ASI-EA	VTSA/ VTSA-F
Miscellaneous							
Primary switched mode modular power supply, AS-i power supply 5 A	SVG1/230VAC-ASI-5A	■	■	■	■	■	■
Primary switched mode modular power supply, 24 V DC power supply 5 A	SVG1/230VAC-24VDC-5A	■	■	■	■	■	■
Primary switched mode modular power supply, 24 V DC power supply 10 A	SVG1/230VAC-24VDC-10A	■	■	■	■	■	■
Addressing device	ASI-PRG-ADR	■	■	■	■	■	■
Addressing cable	KASI-ADR	■	■	■	■	■	■
Inscription labels							
Inscription labels 6x10 in frames (64 pieces)	IBS 6x10	■	■	■	■	-	-
Inscription labels 10x17 in frames (30 pieces)	IBS-10x17	-	-	-	-	-	-
Inscription labels 8x20 in frames (20 pieces)	IBS 8x20	-	-	-	-	■	-
Inscription labels 9x20 in frames (20 pieces)	IBS 9x20	■	■	-	-	-	-
Inscription label holder for connection block, transparent, for paper foil label	VMPA1-ST-1-4	-	-	■	-	-	-
Inscription label holder for connection block, 4-fold, for IBS 6x10	VMPA1-ST-1-4	-	-	■	-	-	-
Clip-on inscription label holder for valve cap (5 pieces)	ASCF-T-S6	-	-	-	-	-	■
Inscription label holder for connection blocks (5 pieces)	ASCF-M-S6	-	-	-	-	-	■
Mounting accessories							
H-rail mounting kit	CP-TS-HS35	-	-	-	■	■	-
H-rail mounting	CPA-BG-NRH	-	■	■	-	-	■
H-rail mounting	CPV10/14-VI-BG-NRH-35, CPV18-VI-BG-NRH-35	■	-	-	-	-	-
H-rail to EN 60715	NRH-35-2000	■	■	■	■	■	■
Mounting bracket	VMPA-BG-RW	-	-	■	-	-	-

AS-interface® components

Accessories



Power supply unit – SVG-1/230VAC...

Primary switched mode modular power supply with integrated data disconnection. The pack supplies the operating voltage to AS-i systems. The first device generates an AS-i direct voltage of 30.1 V DC and an output current of 4.8A. Additional optional, power supplies, 24 V DC, available with 5A or 10A load current, complete the offering. All devices offer high stability and low residual ripple.

The supply outputs are resistant to sustained short circuits. The power pack is suitable both for installation in encapsulated control systems and cabinets as well as for wall mounting. Connection is made via tension springs. The connections are protected against direct contact in conformance with DIN VDE Part 100.

Nominal input voltage:

- 100 ... 240 V AC
 - AS-i load: 4.8 A
- Optional auxiliary power supply
24 V DC:
- Load 5 A or 10 A

AS-interface® components

Accessories

Technical data			
Type	SVG-1/230VAC-ASI-5A	SVG-1/230VAC-24VDC-5A	SVG-1/230VAC-24VDC-10A
Mechanical			
Type of mounting	Via H-rail		
Mounting position	Free convection		
Product weight [g]	900	830	1300
Electrical			
Electrical connections	Spring-loaded terminal		
Input voltage range [V AC]	100 ... 240		
Input current [A]	2.1 ... 1.0	1.9 ... 0.8	2.8 ... 1.2
Mains voltage frequency [Hz]	45 ... 65		
Nominal output voltage [V DC]	30.1 ± 1.5%	24 ± 1%	
Nominal output current [A]	4.8	5	10
Power failure bridging [ms]	20	20	50

Operating and environmental conditions	
Ambient temperature [°C]	-25 ... +70
Storage temperature [°C]	-40 ... +85
Protection class	IP20
Relative air humidity [%]	95
CE mark (see declaration of conformity)	In accordance with EU EMC Directive
	In accordance with EU Low Voltage Directive
Certification	cULus listed (OL)

 Note

Contains PWIS (paint wetting impairment substances).

AS-interface[®] components

Accessories

Dimensions

Download CAD data → www.festo.com

SVG-1/230VAC-ASI-5A

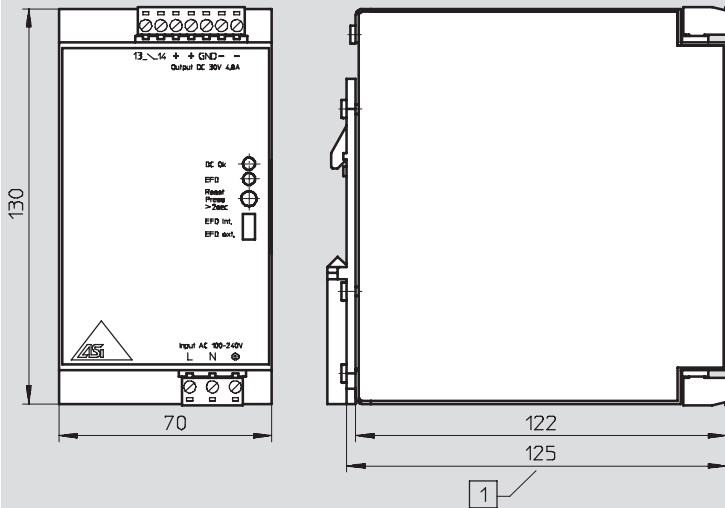

1 H-rail bearing surface

Dimensions

Download CAD data → www.festo.com

SVG-1/230VAC-24VDC-5A

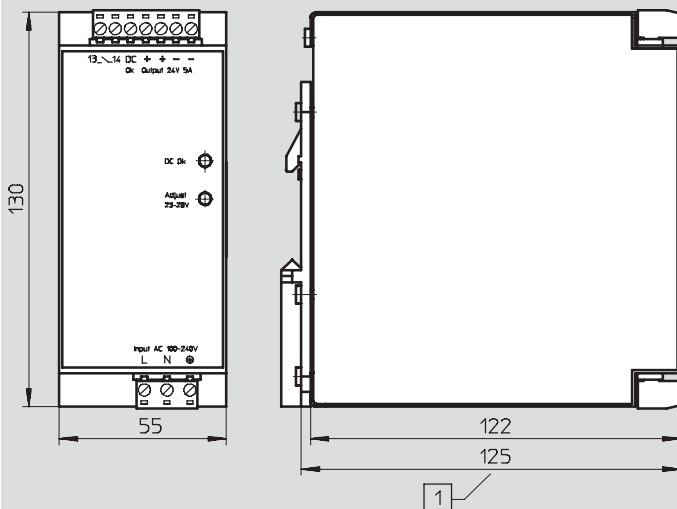

1 H-rail bearing surface

AS-interface® components

Accessories

Dimensions

Download CAD data → www.festo.com

SVG-1/230VAC-24VDC-10A

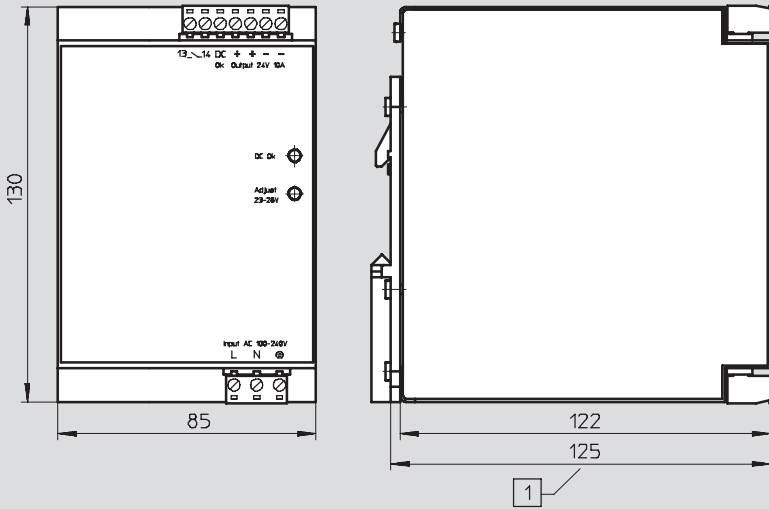

1 H-rail bearing surface



Addressing device – ASI-PRG-ADR

Before an AS-interface network is commissioned, addresses must be assigned to the connected slaves. These addresses are stored in an EEPROM chip on each slave. Each slave is connected to the addressing device for the allocation of an address.

Addressing is simple and is carried out using 5 keys.

The main advantages are:

- Compact design
- Can be addressed on-site

- Supports AS-interface specification C.S.2.1

The addressing device to SPEC V2.1 can be used to scan the AS-interface from any point in the network. At all connected stations

- slave addresses can be read/changed
- ID and IO codes can be read out
- parameters can be read/changed

- input/output data can be read and written (setting outputs)
- error messages can be read out and quickly recognised

Independent of voltage supplies

- Battery operation

Simple reading of error codes

- LCD display

Reliable

- Short circuit-proof
- Overload-proof

Universal adapter connection suitable for a large number of AS-interface slaves. Additional addressing cable for slaves with M12 round plug or flat cable socket optionally available.

Technical data		
Type	ASI-PRG-ADR	
Display	LCD display	
Keyboard	Touch-sensitive keypad with 5 keys	
Power supply	Via battery (charge time approx. 14 hours)	
Charging device	[V AC]	230
Service life	> 250 read/write processes or 8 hours	
Operating temperature	[°C]	0 ... +50
Storage temperature	[°C]	-20 ... +55
Protection class	IP20	
Dimensions	[mm]	80 x 210 x 30
Weight	[g]	275

Dimensions

Download CAD data → www.festo.com

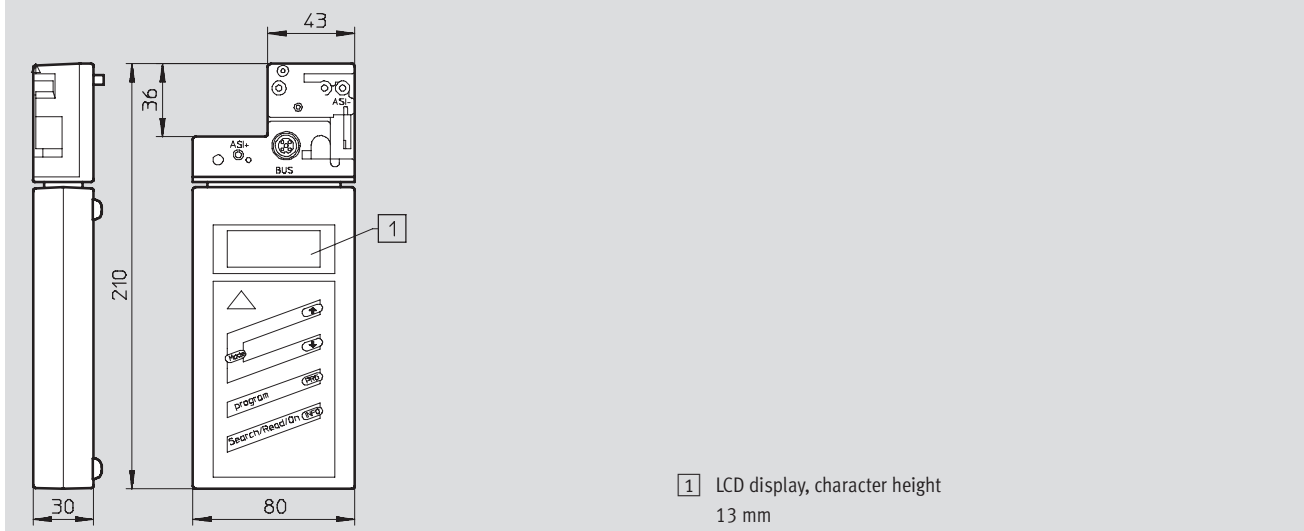

Note

Information on the addressing cable
→ 131

Overview of cables

Addressing cable – KASI-ADR

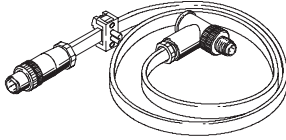

The addressing cable ASI-ADR, available as an accessory, can be used to address any desired slaves either directly via the flat cable connection (FK)

or via the M12 connection (M12):

- Individual valve interface (FK)
- Compact I/O modules (M12)
- CPV valve terminals (FK)

- CPA valve terminals (FK or M12)
- SPC11 Soft Stop (FK)
- DLP-VSE local controller (KF)
- DAPZ sensor box (cable)

Flat cable – KASI-1,5-...-100

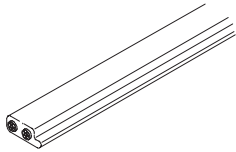

KASI-1,5-Y-100 (yellow)
KASI-1,5-Z-100 (black)

The flat cable is of a 2-wire design. The coding profile prevents polarity reversal of the cable.

AS-interface network stations are connected to the flat cable via insulation displacement technology which utilises contact pins, thus eliminating the need to strip cable and wire insulation.

The yellow cable is normally used for the AS-interface network and the black cable for the auxiliary power supply.

Connecting cable NEBU-M12...-M12...

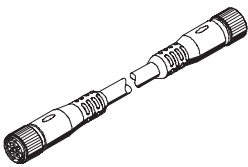

The round cables are of a 4-wire design and are protected against polarity reversal. Standardised connection technology replaces the yellow/black AS-interface cable with a common cable.

- Fixed lengths: 0.2 m, 1 m, 2.5 m and 5 m ex-stock
- NEBU modular system for connecting cables



Note

Define your connecting cable yourself. Select M8 (3-pin or 4-pin) or M12 (4-pin or 5-pin) on each side as required and specify the required cable length and quality – Festo will then supply the exact cable you require.

→ www.festo.com

Flat cable sleeve – ASI-KT-FK



For insulating and sealing the AS-interface cable at the end of the string

- Protection class IP65
- Shrinks on application of heat (hot air blower etc.)

Cable cap – ASI-KK-FK

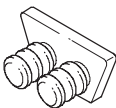

For insulating and sealing the AS-interface cable at the end of the string

- Protection class IP65

Technical data – Flat cable			
Type		KASI-1,5-Y-100	KASI-1,5-Z-100
Cable length	[m]	100	
Colour		Yellow	Black
Cable dimensions		See dimensional drawings	
Cable composition	[mm ²]	2x 1.5	
Wire ends		Open end	
Operating voltage range	[V AC]	0 ... 60	
	[V DC]	0 ... 75	
Current-carrying capacity	[A]	3	
Protection class		IP65 with sealed wire ends	
Ambient temperature	[°C]		
• Fixed cable installation		-40 ... +85	
• Flexible cable installation		-25 ... +85	
Suitable for energy chains		No	
Air humidity		95% non-condensing	
Combustibility		Flame-retardant UL 94 HB	
Corrosion protection class CRC ¹⁾		3	
Product weight	[g/m]	71	
Materials		Sheath: EM3 rubber compound; cable: 3GI3 rubber compound; conductor: tin-coated copper, finely stranded	

1) Corrosion resistance class 3 as per Festo standard 940 070

Components requiring higher corrosion resistance. External visible parts in direct contact with industrial atmospheres or media such as solvents and cleaning agents, with a predominantly functional requirement for the surface.

Technical data – Connecting cable		
Type		NEBU-M12G5-F-0,2-M12G4
Cable length	[m]	0.15
Cable sheath colour		Grey
Housing colour		Black
Cable dimensions		See dimensional drawings
Cable composition	[mm ²]	4x 0.34
Type of mounting		Via threaded connector, via union nut
Tightening torque	[Nm]	Max. 0.6 at M12x1
Electrical connection		5-pin/4-pin; A-coded/A-coded Straight socket/straight plug, M12x1/M12x1
Nominal operating voltage	[V DC]	24 ... 250
Current-carrying capacity	[A]	Max. 4 per contact
Protection class	[IP]	65/67
Ambient temperature	[°C]	
• Fixed cable installation		-5 ... +70
• Flexible cable installation		-5 ... +70
Suitable for energy chains		No
Min. cable bending radius	[mm]	52
Product weight	[g]	26
Materials	Cable sheath	Polyvinyl chloride
	Union nut, screws	Die-cast zinc
	Plug contacts	Copper alloy, gold plated
	Housing	Polyurethane
	Seals	Viton

Dimensions

Download CAD data → www.festo.com

Addressing cable – KASI-ADR

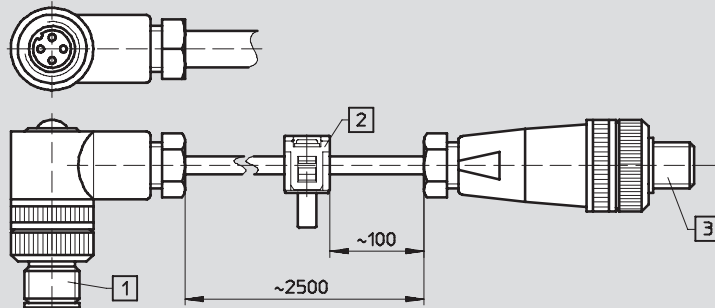

- 1 Round plug connector for connection to addressing device
- 2 Flat cable socket for connecting stations in the AS-interface network with plug-in connection
- 3 Flat cable socket with M12 connection plug for stations in the AS-interface network with M12 interface

Flat cable – KASI-1,5-...-100

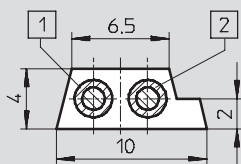

- 1 blue (-)
- 2 brown (+)

Flat cable sleeve – ASI-KT-FK

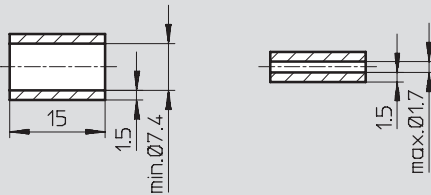

Cable cap – ASI-KK-FK

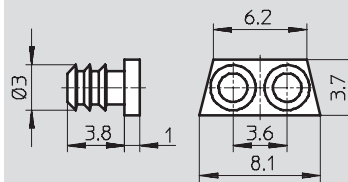

Connecting cable – NEBU-M12G5-F-0.2-M12G4

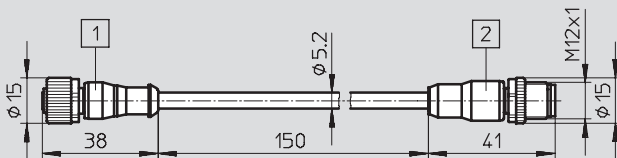

- 1 Straight socket M12
- 2 Straight plug M12

Wiring allocation (socket/plug view)

NEBU-M12G5-F-0.2-M12G4

Plug	Pin	Wire colour/wiring allocation	Pin	Socket
	1	Brown/ASI +	1	
	2	White/0 V load	2	
	3	Blue/ASI -	3	
	4	Black/24 V load	4	

Overview of connection components

Flat cable socket

Flat cable socket for connecting AS-interface network stations to the flat cable. The connection is detachable.

The cable socket is protected against reverse polarity.

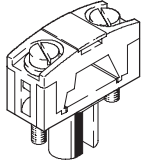

ASI-SD-FK

Flat cable socket for CPV/CPA valve terminals, ASI-EVA.

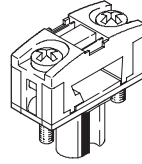

ASI-SD-FK180

Version FK180 for looping through of flat cable on top.

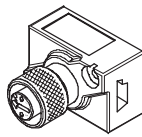

ASI-SD-FK-M12

Flat cable socket with M12 connection for looping through the flat cable. Outlet direction can be turned through 90°. Can be plugged into 4-pin and 5-pin interfaces. Pins 1 and 3 are connected (yellow AS-interface cable). For CPA valve terminal and compact input module (ASI-8DI-M8-3POL).

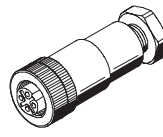

ASI-SD-PG-M12

Flat cable socket with M12 connection and special seal for the flat cable in a PG connector. For CPA valve terminal and compact input module (ASI-8DI-M8-3POL).

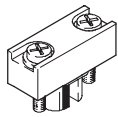

ASI-SD-FK-BL

Blanking plug for sealing unused connections for flat cable sockets.

Flat cable distributors

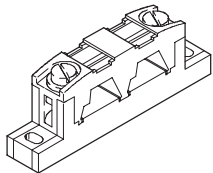

ASI-KVT-FK

Parallel flat cable distributor enables the flat cable to be branched at any desired point to the AS-interface network stations.

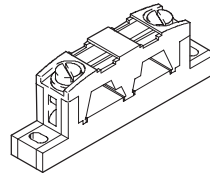

ASI-KVT-FK-S

Symmetrical flat cable distributor that enables the coding profile of the flat cable to be turned through 180° when changing cables. This avoids the need to install a loop. Three cable caps are provided in the scope of delivery to seal the cable ends.

Technical data									
Type		ASI-SD-FK	ASI-SD-FK-180	ASI-SD-FK-M12	ASI-SD-PG-M12	ASI-SD-FK-BL	ASI-KVT-FK	ASI-KVT-FK-S	
Type		–					Parallel cable	Symmetrical cable	
Protection class		IP65		IP65/IP67	IP65				
Operating voltage range	[V AC]	0 ... 60		0 ... 40	0 ... 60				
	[V DC]	0 ... 75		–	0 ... 75				
Current-carrying capacity	[A]	Max. 3		Max. 2	Max. 3				
Temperature range	[°C]	–5 ... +50							
Material of housing		Polyamide		Polyamide	Polyamide				
Product weight	[g]	6.2	6.2	16.8	27.6	1	11.7	11.7	

Download CAD data → www.festo.com

Dimensions

Flat cable socket ASI-SD-FK

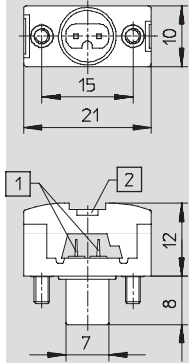

- 1 Contact blades for flat cable contacting
- 2 Inscription label mounting option

Flat cable socket ASI-SD-FK-180

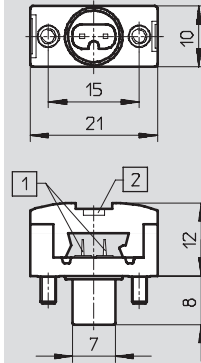

- 1 Contact blades for flat cable contacting
- 2 Inscription label mounting option

Flat cable socket ASI-SD-FK-M12

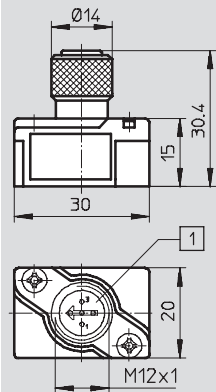

- 1 Coding lug can be turned through 90°
- The socket contains a seal for installation at the end of the string

Blanking plug ASI-SD-FK-BL

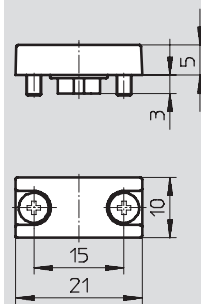

Flat cable distributor ASI-KVT-FK

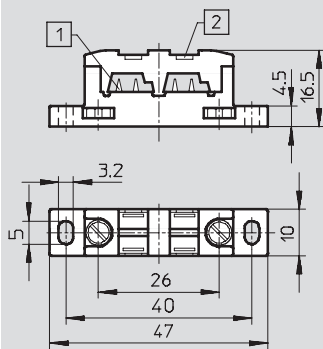

- 1 Contact blades for flat cable contacting
- 2 Inscription label mounting option

Flat cable distributor ASI-KVT-FK-S

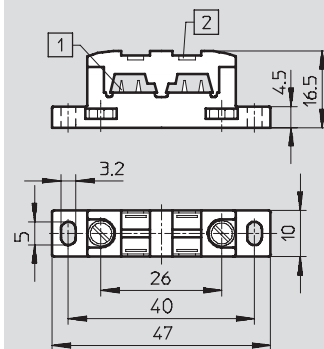

- 1 Contact blades for flat cable contacting
- 2 Inscription label mounting option

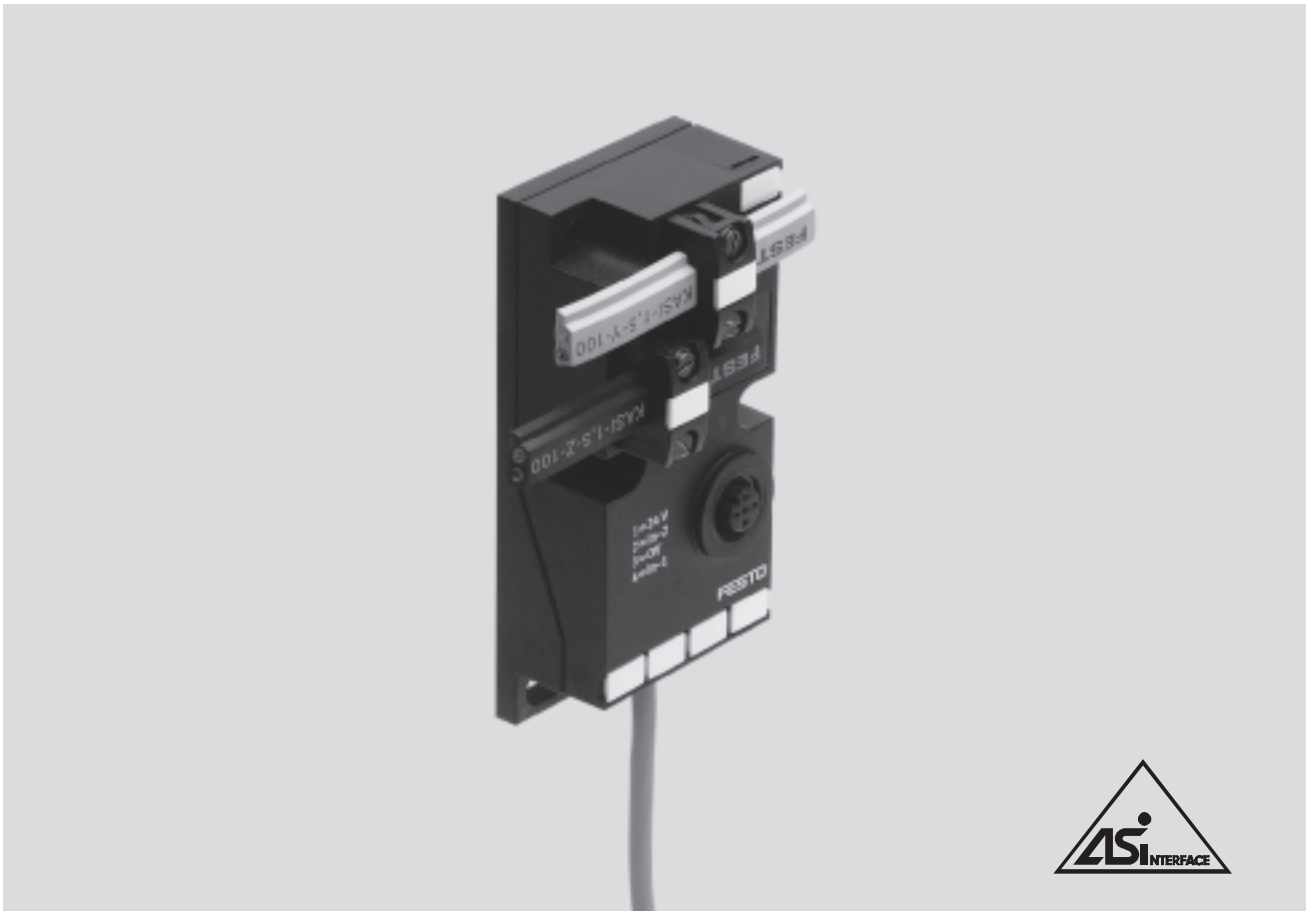

Flat cable distributor yellow/black to 2xM12

ASI-KVT-FKx2-M12

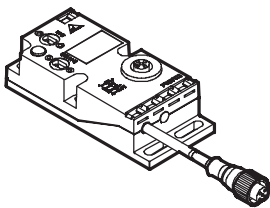

The flat cable distributor is a passive component which recouples flat cables from the AS-interface (yellow and optionally black) to M12 4-pin plug connectors. The flat cable distributor was introduced as an accessory for the CPA valve terminal and the compact I/O modules, but is also

compatible with other slaves available on the market with standardised M12 interface.

An approx. 1 m polyurethane cable with M12 socket is permanently attached to the housing. Alternatively an extension cable

can be connected via an M12 socket integrated in the housing.

The flat cable distributor thus permits new connection technologies on the AS-interface, mainly via round cables in energy chains or environments with higher requirements for easy cleaning.

Pin allocation

AS-interface and auxiliary power supply

5-pin M12-socket and socket at the cable

	<p>1 AS-interface bus 1: + (light blue) 2: - (brown)</p> <p>2 Auxiliary power supply for 1: 0 V 2: + 24 V DC</p>		<p>Pin 1: AS-interface + Pin 2: 0 V (auxiliary power supply) Pin 3: AS-interface - Pin 4: +24 V (auxiliary power supply) Pin 5: Unused</p>
--	--	--	--

Dimensions

Download CAD data → www.festo.com

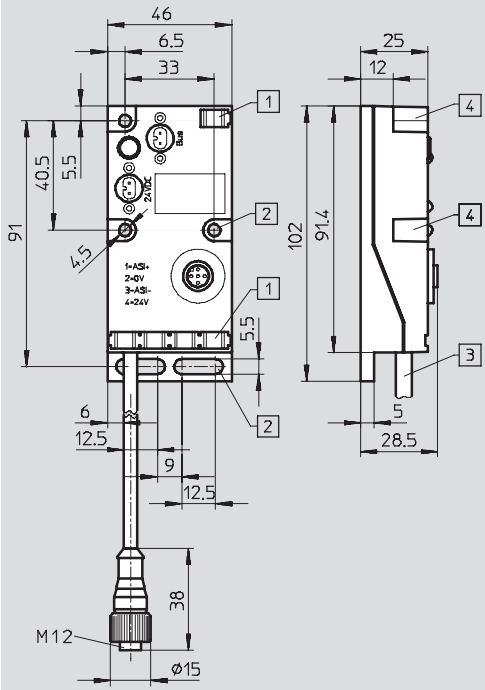

- 1 Inscription label mounting option
- 2 Mounting holes for surface mounting
- 3 Cable PUR-OB, length 1,000 mm
- 4 Mounting holes for ITEM profile 40 mm or other mounting option

Technical data

Type		ASI-KVT-FKx2-M12
AS-interface connection	Connection technology	AS-interface flat cable plug (must be ordered separately)
	Nominal voltage [V DC]	26.5 ... 31.6, reverse polarity protected
	Residual ripple [mVss]	20
24 V DC connection	Connection technology	AS-interface flat cable plug (must be ordered separately)
	Nominal voltage [V DC]	24 (tolerance depends on the connected consuming devices)
	Residual ripple [mVss]	4
General data	Protection class (to EN 60529)	IP65 (fully assembled)
	Cable length [mm]	1000
	Cable cross-sectional area	4x 0.34 mm ²
	CE mark	Yes
	Temperature range [°C]	Operation: -25 ... +85 Storage: -20 ... +70
	Relative air humidity (non-condensing) [%]	5 ... 90
	Materials	<ul style="list-style-type: none"> • Housing: Polyamide • Cable: Polyurethane
	Corrosion resistance class CRC ¹⁾	2
	Shock test	To DIN IEC 68; +/- 30 g at 11 ms, 15 cycles
	Continuous shock test	To DIN IEC 68; +/- 15 g at 6 ms, 1000 cycles
	Vibration test	To DIN IEC 68; 0.35 mm at 10 ... 60 Hz, 5 g at 60 ... 150 Hz
	Protection against direct and indirect contact	PELV (Protected Extra-Low Voltage)
	Dimensions [mm]	Approx. 102 x 46 x 28.5
Weight [g]	Approx. 180	

1) Corrosion resistance class 2 as per Festo standard 940 070
Components subject to moderate corrosion stress. Externally visible parts with primarily decorative surface requirements which are in direct contact with a normal industrial environment or media such as coolants or lubricating agents.

Overview of DUO components

DUO cable – KM12-DUO-M8-...

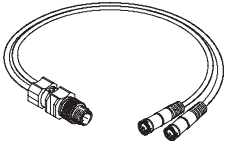

The DUO cables each combine two sensor signals (2x 3-pin cable) on one 4-pin plug. This is routed to the 4-pin or 5-pin input socket of a valve terminal, the ASI-EVA or the compact I/O module.

- 3 variants
- 1 straight plug, 2 straight sockets (GDGD)
 - 1 straight plug, 1 straight socket, 1 angled socket (GDWD)
 - 1 straight plug, 2 angled sockets (WDWD)

T-type plug connector NEDU-...-M12T4

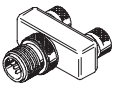

The plug connectors each combine two sensor/actuator signals on one 5-pin plug.

- Variants:
- M12 plug, 2x socket M12, 5-pin
 - M12 plug, 2x socket M8, 3-pin

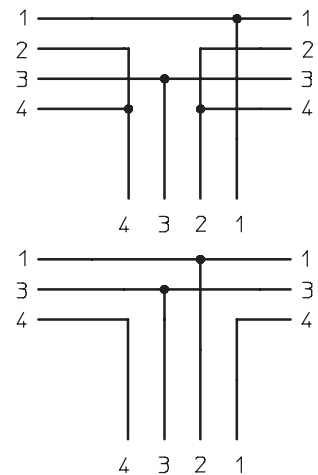

DUO plug – SEA-5GS11-DUO

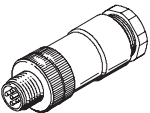

The DUO plug combines two sensor or actuator signals/cables in one housing.

Technical data – DUO cable				
Type		KM12-DUO-M8-GDGD	KM12-DUO-M8-GDWD	KM12-DUO-M8-WDWD
Cable length	[m]	0.5		
Cable composition	[mm ²]	3x 0.25		
Operating voltage range	[V AC]	0 ... 60		
	[V DC]	0 ... 75		
Current-carrying capacity	[A]	Max. 2.8		
Protection class (plugged and screwed in)		IP67		
Ambient temperature	Fixed cable installation	[°C]	-30 ... +70	
	Flexible cable installation	[°C]	-5 ... +70	
Connection		M12 → 2x M8		

Dimensions

Download CAD data → www.festo.com

SEA-5GS11-DUO

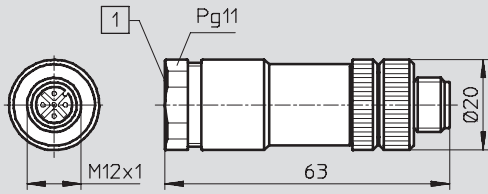

- 1 Included in the scope of delivery:
1x seal insert for 2 cables with
Ø 2.5 ... 2.9 mm
1x seal insert for 2 cables with
Ø 5 mm
1x cable binder

NEDU-M8D3-M12T4

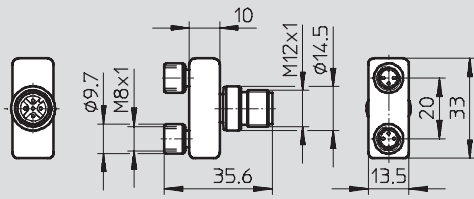

NEDU-M12D5-M12T4

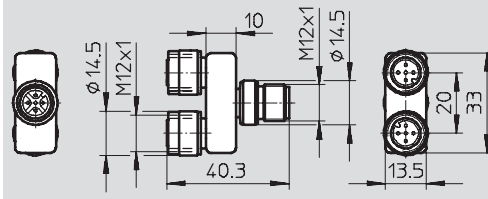

FBSD-GD-9-5POL

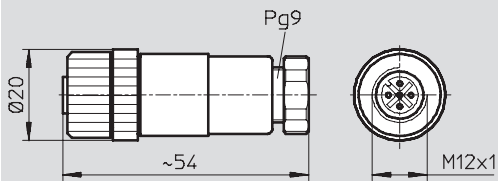

Overview – Other connecting cables

Extension cable – KM-12-M12-GSGD-... etc.

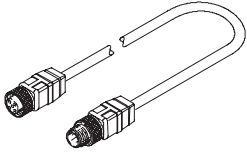

The connecting cables can be used to extend the cable length between a DUO cable and the inputs of a valve terminal, ASI-EVA or a compact

I/O module. They can also be used as AS-interface bus cables for M12 connection technology.

4 variants

- Length 0.15 m, diameter 0.34 mm²
- Length 1 m, diameter 0.34 mm²
- Length 2.5 m, diameter 0.25 mm²
- Length 5 m, diameter 0.25 mm²

Technical data – Extension cable

Type		KM12-M12-GSGD-2,5	KM12-M12-GSGD-5	KM12-M12-GSWD-1-4	NEBU-M12G5-F-0,2-M12G4
Cable length	[m]	2.5	5	1	0.15
Cable composition	[mm ²]	4x 0.25		4x 0.34	4x 0.34
Operating voltage range	[V AC]	0 ... 60		0 ... 60	–
	[V DC]	0 ... 75		0 ... 75	24
Current-carrying capacity	[A]	Max. 3.8			
Protection class (plugged and screwed in)		IP67			
Ambient temperature	[°C]				
• Fixed cable installation		–30 ... +70			–5 ... +70
• Flexible cable installation		–5 ... +70			–5 ... +70
Connection		M12 → M12			

Overview – Other accessories

Inscription labels IBS-...

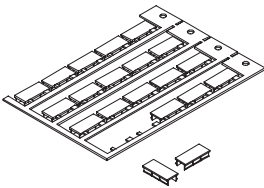







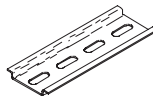

Convenient labelling system for

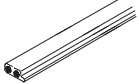
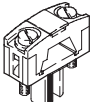
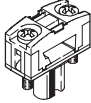
- flat cable sockets
- flat cable distributors
- individual valve interfaces
- compact I/O modules
- CPV/CPA valve terminals



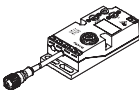
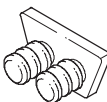

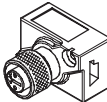
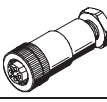



H-rail NRH-35-2000



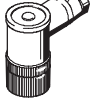

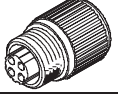
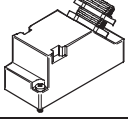

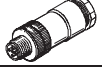

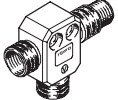

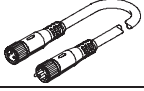
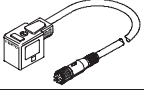
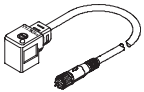
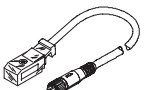
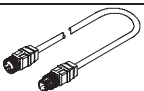
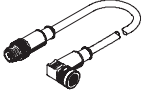
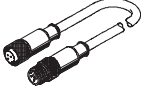
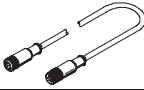
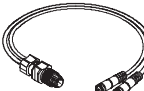

- For compact I/O modules
- CPV/CPA valve terminals
- For individual valve interfaces
- AS-interface power supply units

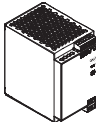
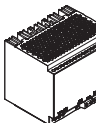
Ordering data				
	Description		Type	Part No.
Bus connection				
	AS-interface flat cable, yellow	100 m	KASI-1,5-Y-100	18940
	AS-interface flat cable, black	100 m	KASI-1,5-Z-100	18941
	Flat cable socket ¹⁾		ASI-SD-FK	18785
	Flat cable socket ¹⁾	Turned through 180°	ASI-SD-FK180	196089
	Flat cable blanking plug		ASI-SD-FK-BL	196090
	AS-interface flat cable distributor	Parallel cable	ASI-KVT-FK	18786
	AS-interface flat cable distributor	Symmetrical cable	ASI-KVT-FK-S	18797
	Cable distributor (yellow and black)	Via 2x M12, 4-pin	ASI-KVT-FKx2-M12	527474
	Cable cap for flat cable (scope of delivery 50 pieces)		ASI-KK-FK	18787
	Cable sleeve (scope of delivery 20 pieces)		ASI-KT-FK	165593
	M12 socket for flat cable		ASI-SD-FK-M12	18788
	M12 socket for flat cable	With PG13.5 connector	ASI-SD-PG-M12	18789
	M12 socket for round cable	With PG9, 5-pin connector	FBSD-GD-9-5POL	18324

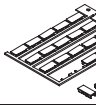
1) Two flat cable connections per ASI-EVA must be connected or covered

Ordering data				
	Description		Type	Part No.
Sensor plugs				
	Straight sensor plug	M12, 5-pin, PG7	SEA-M12-5GS-PG7	175487
	Straight sensor plug	M12, 4-pin, PG7	SEA-GS-7	18666
	Straight sensor plug	M12, PG9, 4-pin	SEA-GS-9	18778
	Angled sensor plug	M12, 4-pin	SEA-M12-4WD-PG7	185498
	Straight sensor plug for cable Ø 2.5 mm	M12, 4-pin	SEA-4GS-7-2,5	192008
	Straight sensor plug	M8, screw-in, 3-pin	SEA-3GS-M8-S	192009
	Straight sensor plug	M8, solderable, 3-pin	SEA-GS-M8	18696
	Harax sensor plug	4-pin	SEA-GS-HAR-4POL	525928
	Sub-D plug	25-pin	SD-SUB-D-ST25	527522
	Protective cap	M12	ISK-M12	165592
	Protective cap	M8	ISK-M8	177672
DUO plugs				
	Plug M12 for 2 sensor cables	4-pin, PG11	SEA-GS-11-DUO	18779
		5-pin, PG11	SEA-5GS-11-DUO	192010
T-type plug connector				
	Plug M12, 2x socket M12 5-pin		NEDU-M12D5-M12T4	541596
	Plug M8 3-pin, to M12 4-pin		NEDU-M8D3-M12T4	541597
	T-adapter for DH-485, M12 5-pin		FB-TA-M12-5POL	171175

Ordering data				
	Description	Type	Part No.	
Connecting cables				
	Modular system for connecting cables → Internet: nebu	NEBU-...	-	
	Connecting cable, straight plug, angled socket type B for F coil	M12, straight, 5-pin, 0.5 m	NEBV-B2W3P-F-0,5-M12G5	542130
		M12, straight, 5-pin, 2.5 m	NEBV-B2W3P-F-2,5-M12G5	542133
	Connecting cable, straight plug, angled socket type C for EB coil	M12, straight, 5-pin, 0.5 m	NEBV-C1W3P-F-0,5-M12G5	542131
		M12, straight, 5-pin, 2.5 m	NEBV-C1W3P-F-2,5-M12G5	542134
	Connecting cable, straight plug, angled socket type KMYZ-9 for ZC coil	M12, straight, 5-pin, 0.5 m	NEBV-Z2W2P-0,5-M12G5	542132
		M12, straight, 5-pin, 2.5 m	NEBV-Z2W2P-2,5-M12G5	542135
	Connecting cable, straight plug, straight socket	M12, 4-pin/5-pin, 0.2 m	NEBU-M12G5-F-0.2-M12G4	542129
		M12, 4-pin, 2.5 m	KM12-M12-GSGD-2,5	18684
	Connecting cable, straight plug, straight socket	M12, 4-pin, 5.0 m	KM12-M12-GSGD-5	18686
	Connecting cable, straight plug, angled socket	M12, 4-pin, 1.0 m	KM12 M12-GSWD-1-4	185499
	Connecting cable, straight plug, straight socket	M8, 0.5 m	KM8-M8-GSGD-0,5	175488
		M8, 1.0 m	KM8-M8-GSGD-1	175489
		M8, 2.5 m	KM8-M8-GSGD-2,5	165610
		M8, 5.0 m	KM8-M8-GSGD-5	165611
	Connecting cable for DNCV	M12, 8-pin	KM12-8GD8GS-2-PU	525617
	DUO cable M12 4-pin to 2xM8, 3-pin	2x straight socket	KM12-DUO-M8-GDGD	18685
		2x straight/angled socket	KM12-DUO-M8-GDWD	18688
		2x angled socket	KM12-DUO-M8-WDWD	18687

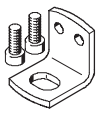
Ordering data			
	Description	Type	Part No.
Miscellaneous			
	Primary switched mode modular power supply AS-i power supply 4.8 A	SVG-1/230VAC-ASI-5A	547869
	Primary switched mode modular power supply 24 VDC power supply 5 A	SVG-1/230-24VDC-5A	547867
	Primary switched mode modular power supply 24 VDC power supply 10 A	SVG-1/230-24VDC-10A	547868
	Addressing device	ASI-PRG-ADR	18959
	Addressing cable	KASI-ADR	18960
Inscription labels			
	Inscription labels 8x20 mm in frames (20 pieces)	IBS-8x20	539388
	Inscription labels 6x10 in frames (64 pieces)	IBS 6x10	18576
	Inscription labels 10x17 in frames (30 pieces)	IBS-10x17	160238
	Inscription labels 9x20 in frames (20 pieces)	IBS 9x20	18182
	Inscription label holder for connection block, transparent, for paper foil label	VMPA1-ST-1-4	533362
	Inscription label holder for connection block, 4-fold, for IBS 6x10	VMPA1 ST 2-4	544384
Mounting accessories			
	Mounting for H-rail	CP-TS-HS35	170169
	Mounting for H-rail	CPA-BG-NRH	173498
	H-rail to EN 60715	NRH-35-2000	35430
	Mounting bracket	VMPA-BG-RW	534416