

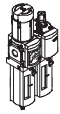

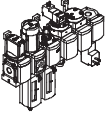



# Wartungseinheiten MSB-FRC, Baureihe MS

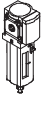

# Wartungseinheiten MSB-FRC, Baureihe MS

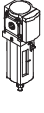
Lieferübersicht Wartungsgeräte Baureihe MS

Typ	Bau- größe	Pneumatischer Anschluss im Gehäuse	Anschlussplatte	Druckregelbereich [bar]						Filterfeinheit [µm]			
				0,05 ...	0,05 ...	0,1 ...	0,3 ...	0,1 ...	0,5 ...	0,01	1	5	40
Code			AG...	D2	D4	D5	D6	D7	D8	A	B	C	E
<b>Wartungseinheiten</b>													
<b>MSB-FRC</b> 	4	G <sup>1</sup> / <sub>8</sub> , G <sup>1</sup> / <sub>4</sub>	G <sup>1</sup> / <sub>8</sub> , G <sup>1</sup> / <sub>4</sub> , G <sup>3</sup> / <sub>8</sub>	-	-	-	■	■	-	-	-	■	■
	6	G <sup>1</sup> / <sub>4</sub> , G <sup>3</sup> / <sub>8</sub> , G <sup>1</sup> / <sub>2</sub>	G <sup>1</sup> / <sub>4</sub> , G <sup>3</sup> / <sub>8</sub> , G <sup>1</sup> / <sub>2</sub> , G <sup>3</sup> / <sub>4</sub>	-	-	-	■	■	-	-	-	■	■
	9	-	-	-	-	-	-	-	-	-	-	-	-
	12	-	-	-	-	-	-	-	-	-	-	-	-
<b>Wartungsgeräte-Kombinationen (weitere Varianten bestellbar über Konfigurator → Internet: msb4, msb6 oder msb9)</b>													
<b>MSB</b> 	4	G <sup>1</sup> / <sub>4</sub>	G <sup>1</sup> / <sub>8</sub> , G <sup>1</sup> / <sub>4</sub> , G <sup>3</sup> / <sub>8</sub>	-	-	-	■	■	-	-	-	■	■
	6	G <sup>1</sup> / <sub>2</sub>	G <sup>1</sup> / <sub>4</sub> , G <sup>3</sup> / <sub>8</sub> , G <sup>1</sup> / <sub>2</sub> , G <sup>3</sup> / <sub>4</sub>	-	-	-	■	■	-	-	-	■	■
	9	-	-	-	-	-	-	-	-	-	-	-	-
	12	-	-	-	-	-	-	-	-	-	-	-	-
<b>Einzelgeräte</b>													
Filterregel- ventile <b>MS-LFR</b> 	4	G <sup>1</sup> / <sub>8</sub> , G <sup>1</sup> / <sub>4</sub>	G <sup>1</sup> / <sub>8</sub> , G <sup>1</sup> / <sub>4</sub> , G <sup>3</sup> / <sub>8</sub>	-	-	■	■	■	-	-	-	■	■
	6	G <sup>1</sup> / <sub>4</sub> , G <sup>3</sup> / <sub>8</sub> , G <sup>1</sup> / <sub>2</sub>	G <sup>1</sup> / <sub>4</sub> , G <sup>3</sup> / <sub>8</sub> , G <sup>1</sup> / <sub>2</sub> , G <sup>3</sup> / <sub>4</sub>	-	-	■	■	■	■	-	-	■	■
	9	G <sup>3</sup> / <sub>4</sub> , G1	G <sup>1</sup> / <sub>2</sub> , G <sup>3</sup> / <sub>4</sub> , G1, G <sup>1</sup> / <sub>4</sub> , G <sup>1</sup> / <sub>2</sub>	-	-	■	■	-	-	-	-	■	■
	12	-	G1, G <sup>1</sup> / <sub>4</sub> , G <sup>1</sup> / <sub>2</sub> , G2	-	-	-	■	■	■	-	-	■	■
Filter <b>MS-LF</b> 	4	G <sup>1</sup> / <sub>8</sub> , G <sup>1</sup> / <sub>4</sub>	G <sup>1</sup> / <sub>8</sub> , G <sup>1</sup> / <sub>4</sub> , G <sup>3</sup> / <sub>8</sub>	-	-	-	-	-	-	-	-	■	■
	6	G <sup>1</sup> / <sub>4</sub> , G <sup>3</sup> / <sub>8</sub> , G <sup>1</sup> / <sub>2</sub>	G <sup>1</sup> / <sub>4</sub> , G <sup>3</sup> / <sub>8</sub> , G <sup>1</sup> / <sub>2</sub> , G <sup>3</sup> / <sub>4</sub>	-	-	-	-	-	-	-	-	■	■
	9	G <sup>3</sup> / <sub>4</sub> , G1	G <sup>1</sup> / <sub>2</sub> , G <sup>3</sup> / <sub>4</sub> , G1, G <sup>1</sup> / <sub>4</sub> , G <sup>1</sup> / <sub>2</sub>	-	-	-	-	-	-	-	-	■	■
	12	-	G1, G <sup>1</sup> / <sub>4</sub> , G <sup>1</sup> / <sub>2</sub> , G2	-	-	-	-	-	-	-	-	■	■
Fein- und Feinstfilter <b>MS-LFM</b> 	4	G <sup>1</sup> / <sub>8</sub> , G <sup>1</sup> / <sub>4</sub>	G <sup>1</sup> / <sub>8</sub> , G <sup>1</sup> / <sub>4</sub> , G <sup>3</sup> / <sub>8</sub>	-	-	-	-	-	-	■	■	-	-
	6	G <sup>1</sup> / <sub>4</sub> , G <sup>3</sup> / <sub>8</sub> , G <sup>1</sup> / <sub>2</sub>	G <sup>1</sup> / <sub>4</sub> , G <sup>3</sup> / <sub>8</sub> , G <sup>1</sup> / <sub>2</sub> , G <sup>3</sup> / <sub>4</sub>	-	-	-	-	-	-	■	■	-	-
	9	G <sup>3</sup> / <sub>4</sub> , G1	G <sup>1</sup> / <sub>2</sub> , G <sup>3</sup> / <sub>4</sub> , G1, G <sup>1</sup> / <sub>4</sub> , G <sup>1</sup> / <sub>2</sub>	-	-	-	-	-	-	■	■	-	-
	12	-	G1, G <sup>1</sup> / <sub>4</sub> , G <sup>1</sup> / <sub>2</sub> , G2	-	-	-	-	-	-	■	■	-	-
Aktivkohle- filter <b>MS-LFX</b> 	4	G <sup>1</sup> / <sub>8</sub> , G <sup>1</sup> / <sub>4</sub>	G <sup>1</sup> / <sub>8</sub> , G <sup>1</sup> / <sub>4</sub> , G <sup>3</sup> / <sub>8</sub>	-	-	-	-	-	-	-	-	-	-
	6	G <sup>1</sup> / <sub>4</sub> , G <sup>3</sup> / <sub>8</sub> , G <sup>1</sup> / <sub>2</sub>	G <sup>1</sup> / <sub>4</sub> , G <sup>3</sup> / <sub>8</sub> , G <sup>1</sup> / <sub>2</sub> , G <sup>3</sup> / <sub>4</sub>	-	-	-	-	-	-	-	-	-	-
	9	G <sup>3</sup> / <sub>4</sub> , G1	G <sup>1</sup> / <sub>2</sub> , G <sup>3</sup> / <sub>4</sub> , G1, G <sup>1</sup> / <sub>4</sub> , G <sup>1</sup> / <sub>2</sub>	-	-	-	-	-	-	-	-	-	-
	12	-	G1, G <sup>1</sup> / <sub>4</sub> , G <sup>1</sup> / <sub>2</sub> , G2	-	-	-	-	-	-	-	-	-	-
Wasser- abscheider <b>MS-LWS</b> 	4	-	-	-	-	-	-	-	-	-	-	-	-
	6	G <sup>1</sup> / <sub>4</sub> , G <sup>3</sup> / <sub>8</sub> , G <sup>1</sup> / <sub>2</sub>	G <sup>1</sup> / <sub>4</sub> , G <sup>3</sup> / <sub>8</sub> , G <sup>1</sup> / <sub>2</sub> , G <sup>3</sup> / <sub>4</sub>	-	-	-	-	-	-	-	-	-	-
	9	-	-	-	-	-	-	-	-	-	-	-	-
	12	-	-	-	-	-	-	-	-	-	-	-	-

# Wartungseinheiten MSB-FRC, Baureihe MS

Lieferübersicht Wartungsgeräte Baureihe MS

Typ	Bau- größe	Schalen- schutz		Kondensatablass				Druckanzeige					Abschließ- barkeit		Optionen		→ Seite/ Internet	
		Kunststoffschutzkorb	Metallschale	manuell drehend	halbautomatisch	vollautomatisch	extern, vollautoma- tisch, elektrisch	Verschlussblende (ohne Manometer)	integriertes MS-Manometer	Adapter EN-Manometer G <sup>1</sup> / <sub>8</sub>	Adapter EN-Manometer G <sup>1</sup> / <sub>4</sub>	Drucksensor	Drehknopf mit Arre- tierung, mit Zubehör schließbar	Drehknopf mit inte- griertem Schloss	Schalldämpfer	Durchflussrichtung von rechts nach links		
Code		R	U	M	H	V	E...	VS	AG	A8	A4	AD...	AS	E11	S	Z		
<b>Wartungseinheiten</b>																		
<b>MSB-FRC</b>	4	■	-	■	-	■	-	-	■	-	-	-	■	-	-	■	8	
	6	■	■	■	-	■	-	-	■	-	-	-	■	-	-	■	8	
	9	-	-	-	-	-	-	-	-	-	-	-	-	-	-	-	-	
	12	-	-	-	-	-	-	-	-	-	-	-	-	-	-	-	-	
<b>Wartungsgeräte-Kombinationen</b>																		
<b>MSB</b>	4	■	■	■	-	■	-	-	■	-	-	-	■	-	-	■	msb4	
	6	■	■	■	-	■	-	-	■	-	-	-	■	-	-	■	msb6	
	9	-	-	-	-	-	-	-	-	-	-	-	-	-	-	-	-	
	12	-	-	-	-	-	-	-	-	-	-	-	-	-	-	-	-	
<b>Einzelgeräte</b>																		
Filterregel- ventile	4	■	■	■	■	■	-	■	■	■	■	■	■	■	■	-	■	ms4-lfr
	6	■	■	■	■	■	■	■	■	■	-	■	■	■	■	-	■	ms6-lfr
<b>MS-LFR</b>	9	-	■	■	■	■	■	■	■	-	■	■	■	■	-	■	ms9-lfr	
	12	-	■	■	-	■	■	■	■	-	■	-	■	■	-	■	ms12-lfr	
Filter <b>MS-LF</b>	4	■	■	■	■	■	-	-	-	-	-	-	-	-	-	■	ms4-lf	
	6	■	■	■	■	■	■	-	-	-	-	-	-	-	-	■	ms6-lf	
	9	-	■	■	■	■	■	-	-	-	-	-	-	-	-	■	ms9-lf	
	12	-	■	■	-	■	■	-	-	-	-	-	-	-	-	■	ms12-lf	
Fein- und Feinstfilter <b>MS-LFM</b>	4	■	■	■	■	■	-	-	-	-	-	-	-	-	-	■	ms4-lfm	
	6	■	■	■	■	■	■	-	-	-	-	-	-	-	-	■	ms6-lfm	
	9	-	■	■	-	■	■	-	-	-	-	-	-	-	-	■	ms9-lfm	
	12	-	■	■	-	■	■	-	-	-	-	-	-	-	-	■	ms12-lfm	
Aktivkohle- filter <b>MS-LFX</b>	4	■	■	-	-	-	-	-	-	-	-	-	-	-	-	■	ms4-lfx	
	6	■	■	-	-	-	-	-	-	-	-	-	-	-	-	■	ms6-lfx	
	9	-	■	-	-	-	-	-	-	-	-	-	-	-	-	■	ms9-lfx	
	12	-	■	-	-	-	-	-	-	-	-	-	-	-	-	■	ms12-lfx	
Wasser- abscheider <b>MS-LWS</b>	4	-	-	-	-	-	-	-	-	-	-	-	-	-	-	-	-	
	6	-	■	-	-	■	■	-	-	-	-	-	-	-	-	■	ms6-lws	
	9	-	-	-	-	-	-	-	-	-	-	-	-	-	-	-	-	
	12	-	-	-	-	-	-	-	-	-	-	-	-	-	-	-	-	

# Wartungseinheiten MSB-FRC, Baureihe MS

Lieferübersicht Wartungsgeräte Baureihe MS



Typ	Bau- größe	Pneumatischer Anschluss im Gehäuse	Anschlussplatte	Druckregelbereich [bar]						Versorgungsspannung				
				0,05 ... 0,7	0,05 ... 2,5	0,1 ... 4	0,3 ... 7	0,1 ... 12	0,5 ... 16	24 V DC, Anschluss- bild nach EN 175301	24 V DC, Anschluss- bild M12 nach DESINA	110 V AC, Anschluss- bild nach EN 175301	230 V AC, Anschluss- bild nach EN 175301	
Code			AG...	D2	D4	D5	D6	D7	D8	V24	V24P	V110	V230	
<b>Einzelgeräte</b>														
Druckregel- ventile <b>MS-LR</b>		4	G <sup>1</sup> / <sub>8</sub> , G <sup>1</sup> / <sub>4</sub>	G <sup>1</sup> / <sub>8</sub> , G <sup>1</sup> / <sub>4</sub> , G <sup>3</sup> / <sub>8</sub>	-	-	■	■	■	-	-	-	-	
		6	G <sup>1</sup> / <sub>4</sub> , G <sup>3</sup> / <sub>8</sub> , G <sup>1</sup> / <sub>2</sub>	G <sup>1</sup> / <sub>4</sub> , G <sup>3</sup> / <sub>8</sub> , G <sup>1</sup> / <sub>2</sub> , G <sup>3</sup> / <sub>4</sub>	-	-	■	■	■	■	-	-	-	-
		9	G <sup>3</sup> / <sub>4</sub> , G1	G <sup>1</sup> / <sub>2</sub> , G <sup>3</sup> / <sub>4</sub> , G1, G1 <sup>1</sup> / <sub>4</sub> , G1 <sup>1</sup> / <sub>2</sub>	-	-	■	■	-	-	-	-	-	-
		12	-	G1, G1 <sup>1</sup> / <sub>4</sub> , G1 <sup>1</sup> / <sub>2</sub> , G2	-	-	-	■	■	■	-	-	-	-
Druckregel- ventile <b>MS-LRB</b>		4	G <sup>1</sup> / <sub>4</sub>	G <sup>1</sup> / <sub>8</sub> , G <sup>1</sup> / <sub>4</sub> , G <sup>3</sup> / <sub>8</sub>	-	-	■	■	■	-	-	-	-	
		6	G <sup>1</sup> / <sub>2</sub>	G <sup>1</sup> / <sub>4</sub> , G <sup>3</sup> / <sub>8</sub> , G <sup>1</sup> / <sub>2</sub> , G <sup>3</sup> / <sub>4</sub>	-	-	■	■	■	■	-	-	-	-
		9	-	-	-	-	-	-	-	-	-	-	-	-
		12	-	-	-	-	-	-	-	-	-	-	-	-
Präzisions- Druckregel- ventile <b>MS-LRP</b>		4	-	-	-	-	-	-	-	-	-	-	-	
		6	G <sup>1</sup> / <sub>4</sub> , G <sup>3</sup> / <sub>8</sub> , G <sup>1</sup> / <sub>2</sub>	G <sup>1</sup> / <sub>4</sub> , G <sup>3</sup> / <sub>8</sub> , G <sup>1</sup> / <sub>2</sub> , G <sup>3</sup> / <sub>4</sub>	■	■	■	-	■	-	-	-	-	-
		9	-	-	-	-	-	-	-	-	-	-	-	-
		12	-	-	-	-	-	-	-	-	-	-	-	-
Präzisions- Druckregel- ventile <b>MS-LRPB</b>		4	-	-	-	-	-	-	-	-	-	-	-	
		6	G <sup>1</sup> / <sub>2</sub>	G <sup>1</sup> / <sub>4</sub> , G <sup>3</sup> / <sub>8</sub> , G <sup>1</sup> / <sub>2</sub> , G <sup>3</sup> / <sub>4</sub>	■	■	■	-	■	-	-	-	-	-
		9	-	-	-	-	-	-	-	-	-	-	-	-
		12	-	-	-	-	-	-	-	-	-	-	-	-
Elektrik-Druck- regelventile <b>MS-LRE</b>		4	-	-	-	-	-	-	-	-	-	-	-	
		6	G <sup>1</sup> / <sub>4</sub> , G <sup>3</sup> / <sub>8</sub> , G <sup>1</sup> / <sub>2</sub>	G <sup>1</sup> / <sub>4</sub> , G <sup>3</sup> / <sub>8</sub> , G <sup>1</sup> / <sub>2</sub> , G <sup>3</sup> / <sub>4</sub>	-	-	■	■	■	■	-	-	-	-
		9	-	-	-	-	-	-	-	-	-	-	-	-
		12	-	-	-	-	-	-	-	-	-	-	-	-
Öler <b>MS-LOE</b>		4	G <sup>1</sup> / <sub>8</sub> , G <sup>1</sup> / <sub>4</sub>	G <sup>1</sup> / <sub>8</sub> , G <sup>1</sup> / <sub>4</sub> , G <sup>3</sup> / <sub>8</sub>	-	-	-	-	-	-	-	-	-	
		6	G <sup>1</sup> / <sub>4</sub> , G <sup>3</sup> / <sub>8</sub> , G <sup>1</sup> / <sub>2</sub>	G <sup>1</sup> / <sub>4</sub> , G <sup>3</sup> / <sub>8</sub> , G <sup>1</sup> / <sub>2</sub> , G <sup>3</sup> / <sub>4</sub>	-	-	-	-	-	-	-	-	-	
		9	-	-	-	-	-	-	-	-	-	-	-	
		12	-	G1, G1 <sup>1</sup> / <sub>4</sub> , G1 <sup>1</sup> / <sub>2</sub> , G2	-	-	-	-	-	-	-	-	-	-
Einschalt- ventile <b>MS-EM(1)</b>		4	G <sup>1</sup> / <sub>8</sub> , G <sup>1</sup> / <sub>4</sub>	G <sup>1</sup> / <sub>8</sub> , G <sup>1</sup> / <sub>4</sub> , G <sup>3</sup> / <sub>8</sub>	-	-	-	-	-	-	-	-	-	
		6	G <sup>1</sup> / <sub>4</sub> , G <sup>3</sup> / <sub>8</sub> , G <sup>1</sup> / <sub>2</sub>	G <sup>1</sup> / <sub>4</sub> , G <sup>3</sup> / <sub>8</sub> , G <sup>1</sup> / <sub>2</sub> , G <sup>3</sup> / <sub>4</sub>	-	-	-	-	-	-	-	-	-	
		9	G <sup>3</sup> / <sub>4</sub> , G1	G <sup>1</sup> / <sub>2</sub> , G <sup>3</sup> / <sub>4</sub> , G1, G1 <sup>1</sup> / <sub>4</sub> , G1 <sup>1</sup> / <sub>2</sub>	-	-	-	-	-	-	-	-	-	
		12	-	G1, G1 <sup>1</sup> / <sub>4</sub> , G1 <sup>1</sup> / <sub>2</sub> , G2	-	-	-	-	-	-	-	-	-	
Einschalt- ventile <b>MS-EE</b>		4	G <sup>1</sup> / <sub>8</sub> , G <sup>1</sup> / <sub>4</sub>	G <sup>1</sup> / <sub>8</sub> , G <sup>1</sup> / <sub>4</sub> , G <sup>3</sup> / <sub>8</sub>	-	-	-	-	-	-	■	-	■	
		6	G <sup>1</sup> / <sub>4</sub> , G <sup>3</sup> / <sub>8</sub> , G <sup>1</sup> / <sub>2</sub>	G <sup>1</sup> / <sub>4</sub> , G <sup>3</sup> / <sub>8</sub> , G <sup>1</sup> / <sub>2</sub> , G <sup>3</sup> / <sub>4</sub>	-	-	-	-	-	-	■	-	■	
		9	G <sup>3</sup> / <sub>4</sub> , G1	G <sup>1</sup> / <sub>2</sub> , G <sup>3</sup> / <sub>4</sub> , G1, G1 <sup>1</sup> / <sub>4</sub> , G1 <sup>1</sup> / <sub>2</sub>	-	-	-	-	-	-	■	■	■	
		12	-	G1, G1 <sup>1</sup> / <sub>4</sub> , G1 <sup>1</sup> / <sub>2</sub> , G2	-	-	-	-	-	-	■	■	■	
Druckaufbau- ventile <b>MS-DL</b>		4	G <sup>1</sup> / <sub>8</sub> , G <sup>1</sup> / <sub>4</sub>	G <sup>1</sup> / <sub>8</sub> , G <sup>1</sup> / <sub>4</sub> , G <sup>3</sup> / <sub>8</sub>	-	-	-	-	-	-	-	-	-	
		6	G <sup>1</sup> / <sub>4</sub> , G <sup>3</sup> / <sub>8</sub> , G <sup>1</sup> / <sub>2</sub>	G <sup>1</sup> / <sub>4</sub> , G <sup>3</sup> / <sub>8</sub> , G <sup>1</sup> / <sub>2</sub> , G <sup>3</sup> / <sub>4</sub>	-	-	-	-	-	-	-	-	-	
		9	-	-	-	-	-	-	-	-	-	-	-	
		12	-	G1, G1 <sup>1</sup> / <sub>4</sub> , G1 <sup>1</sup> / <sub>2</sub> , G2	-	-	-	-	-	-	-	-	-	
Druckaufbau- ventile <b>MS-DE</b>		4	G <sup>1</sup> / <sub>8</sub> , G <sup>1</sup> / <sub>4</sub>	G <sup>1</sup> / <sub>8</sub> , G <sup>1</sup> / <sub>4</sub> , G <sup>3</sup> / <sub>8</sub>	-	-	-	-	-	-	■	-	■	
		6	G <sup>1</sup> / <sub>4</sub> , G <sup>3</sup> / <sub>8</sub> , G <sup>1</sup> / <sub>2</sub>	G <sup>1</sup> / <sub>4</sub> , G <sup>3</sup> / <sub>8</sub> , G <sup>1</sup> / <sub>2</sub> , G <sup>3</sup> / <sub>4</sub>	-	-	-	-	-	-	■	-	■	
		9	-	-	-	-	-	-	-	-	-	-	-	
		12	-	G1, G1 <sup>1</sup> / <sub>4</sub> , G1 <sup>1</sup> / <sub>2</sub> , G2	-	-	-	-	-	-	■	■	■	
Druckaufbau- und Entlüf- tungsventile <b>MS-SV</b>		4	-	-	-	-	-	-	-	-	-	-	-	
		6	G <sup>1</sup> / <sub>2</sub>	G <sup>1</sup> / <sub>4</sub> , G <sup>3</sup> / <sub>8</sub> , G <sup>1</sup> / <sub>2</sub> , G <sup>3</sup> / <sub>4</sub>	-	-	-	-	-	-	■	-	-	
		9	-	-	-	-	-	-	-	-	-	-	-	
		12	-	-	-	-	-	-	-	-	-	-	-	

# Wartungseinheiten MSB-FRC, Baureihe MS





Lieferübersicht Wartungsgeräte Baureihe MS



Typ	Bau- größe	Schalenschutz		Druckanzeige				Abschließbar- keit		Optionen		→ Seite/ Internet	
		Kunststoffschutzkorb	Metallschale	Verschlussblende (ohne Manometer)	integriertes MS-Manometer	Adapter EN-Manometer G $\frac{1}{8}$	Adapter EN-Manometer G $\frac{1}{4}$	Drucksensor	Drehknopf mit Arre- tierung, mit Zubehör schließbar	Drehknopf mit inte- griertem Schloss	Schalldämpfer		Durchflussrichtung von rechts nach links
Code		R	U	VS	AG	A8	A4	AD...	AS	E11	S	Z	
<b>Einzelgeräte</b>													
Druckregel- ventile <b>MS-LR</b>	4	-	-	■	■	■	■	■	■	■	-	■	ms4-lr
	6	-	-	■	■	-	■	■	■	■	-	■	ms6-lr
	9	-	-	■	■	-	■	■	■	■	-	■	ms9-lr
	12	-	-	■	■	-	■	-	■	■	-	■	ms12-lr
Druckregel- ventile <b>MS-LRB</b>	4	-	-	■	■	■	■	■	■	■	-	■	ms4-lrb
	6	-	-	■	■	-	■	■	■	■	-	■	ms6-lrb
	9	-	-	-	-	-	-	-	-	-	-	-	-
	12	-	-	-	-	-	-	-	-	-	-	-	-
Präzisions- Druckregel- ventile <b>MS-LRP</b>	4	-	-	-	-	-	-	-	-	-	-	-	-
	6	-	-	■	-	■	■	■	■	■	-	■	ms6-lrp
	9	-	-	-	-	-	-	-	-	-	-	-	-
	12	-	-	-	-	-	-	-	-	-	-	-	-
Präzisions- Druckregel- ventile <b>MS-LRPB</b>	4	-	-	-	-	-	-	-	-	-	-	-	-
	6	-	-	■	-	■	■	■	■	■	-	■	ms6-lrpb
	9	-	-	-	-	-	-	-	-	-	-	-	-
	12	-	-	-	-	-	-	-	-	-	-	-	-
Elektrik-Druck- regelventile <b>MS-LRE</b>	4	-	-	-	-	-	-	-	-	-	-	-	-
	6	-	-	■	■	-	■	-	-	-	-	■	ms6-lre
	9	-	-	-	-	-	-	-	-	-	-	-	-
	12	-	-	-	-	-	-	-	-	-	-	-	-
Öler <b>MS-LOE</b>	4	■	■	-	-	-	-	-	-	-	-	■	ms4-loe
	6	■	■	-	-	-	-	-	-	-	-	■	ms6-loe
	9	-	-	-	-	-	-	-	-	-	-	-	-
	12	-	■	-	-	-	-	-	-	-	-	■	ms12-loe
Einschalt- ventile <b>MS-EM(1)</b>	4	-	-	■	■	■	■	■	-	-	■	■	ms4-em1
	6	-	-	■	■	-	■	■	-	-	■	■	ms6-em1
	9	-	-	■	■	-	■	■	-	-	■	■	ms9-em
	12	-	-	■	■	-	■	-	-	-	■	■	ms12-em
Einschalt- ventile <b>MS-EE</b>	4	-	-	■	■	■	■	■	-	-	■	■	ms4-ee
	6	-	-	■	■	-	■	■	-	-	■	■	ms6-ee
	9	-	-	■	■	-	■	■	-	-	■	■	ms9-ee
	12	-	-	■	■	-	■	-	-	-	■	■	ms12-ee
Druckaufbau- ventile <b>MS-DL</b>	4	-	-	■	■	■	■	■	-	-	-	■	ms4-dl
	6	-	-	■	■	-	■	■	-	-	-	■	ms6-dl
	9	-	-	-	-	-	-	-	-	-	-	-	-
	12	-	-	■	■	-	■	-	-	-	-	■	ms12-dl
Druckaufbau- ventile <b>MS-DE</b>	4	-	-	■	■	■	■	■	-	-	-	■	ms4-de
	6	-	-	■	■	-	■	■	-	-	-	■	ms6-de
	9	-	-	-	-	-	-	-	-	-	-	-	-
	12	-	-	■	■	-	■	-	-	-	-	■	ms12-de
Druckaufbau- und Entlüf- tungsventile <b>MS-SV</b>	4	-	-	-	-	-	-	-	-	-	-	-	-
	6	-	-	■	■	-	■	■	-	-	■	■	ms6-sv
	9	-	-	-	-	-	-	-	-	-	-	-	-
	12	-	-	-	-	-	-	-	-	-	-	-	-

# Wartungseinheiten MSB-FRC, Baureihe MS

Lieferübersicht Wartungsgeräte Baureihe MS

Typ	Bau- größe	Pneumatischer Anschluss im Gehäuse	Anschlussplatte	Druckregelbereich [bar]				Versorgungsspannung			
				0,1 ... 4	0,3 ... 7	0,1 ... 12	0,5 ... 16	24 V DC, Anschluss- bild nach EN 175301	24 V DC, Anschluss- bild M12 nach DESINA	110 V AC, Anschluss- bild nach EN 175301	230 V AC, Anschluss- bild nach EN 175301
Code			AG...	D5	D6	D7	D8	V24	V24P	V110	V230
<b>Einzelgeräte</b>											
Membran- Lufttrockner <b>MS-LDM1</b>		4	G1/8, G1/4	G1/8, G1/4, G3/8	-	-	-	-	-	-	-
		6	G1/4, G3/8, G1/2	G1/4, G3/8, G1/2, G3/4	-	-	-	-	-	-	-
		9	-	-	-	-	-	-	-	-	-
		12	-	-	-	-	-	-	-	-	-
Abzweig- module <b>MS-FRM</b>		4	G1/8, G1/4	G1/8, G1/4, G3/8	-	-	-	-	-	-	-
		6	G1/4, G3/8, G1/2	G1/4, G3/8, G1/2, G3/4	-	-	-	-	-	-	-
		9	G3/4, G1	G1/2, G3/4, G1, G1 1/4, G1 1/2	-	-	-	-	-	-	-
		12	-	G1, G1 1/4, G1 1/2, G2	-	-	-	-	-	-	-
Verteiler- blöcke <b>MS-FRM-FRZ</b>		4	G1/4	-	-	-	-	-	-	-	-
		6	G1/2	-	-	-	-	-	-	-	-
		9	-	-	-	-	-	-	-	-	-
		12	-	-	-	-	-	-	-	-	-
Durchfluss- sensoren <b>SFAM</b>		4	-	-	-	-	-	-	-	-	-
		6	G1/2	G1/2	-	-	-	-	-	-	-
		9	-	-	-	-	-	-	-	-	-
		12	-	-	-	-	-	-	-	-	-

# Wartungseinheiten MSB-FRC, Baureihe MS

Lieferübersicht Wartungsgeräte Baureihe MS

Typ	Bau- größe	Schalenschutz		Druckanzeige				Schaltausgang		Optionen		→ Seite/ Internet	
		Kunststoffschutzkorb	Metallschale	Verschlussblende (ohne Manometer)	integriertes MS-Manometer	Adapter EN-Manometer G <sup>1</sup> / <sub>8</sub>	Adapter EN-Manometer G <sup>1</sup> / <sub>4</sub>	Drucksensor	2x PNP	2x NPN	Schalldämpfer		Durchflussrichtung von rechts nach links
Code		R	U	VS	AG	A8	A4	AD...	P2/2S	N2/2S	S	Z/R	
<b>Einzelgeräte</b>													
Membran- Lufttrockner <b>MS-LDM1</b>	4	-	■	-	-	-	-	-	-	-	-	■	ms4-ldm1
	6	-	■	-	-	-	-	-	-	-	-	■	ms6-ldm1
	9	-											-
	12	-											-
Abzweig- module <b>MS-FRM</b>	4	-	-	■	■	■	■	■	-	-	-	■	ms4-frm
	6	-	-	■	■	-	■	■	-	-	-	■	ms6-frm
	9	-	-	■	■	-	■	■	-	-	-	■	ms9-frm
	12	-	-	■	-	-	-	-	-	-	-	-	ms12-frm
Verteiler- blöcke <b>MS-FRM-FRZ</b>	4	-	-	-	-	-	-	-	-	-	-	■	ms4-frm
	6	-	-	-	-	-	-	-	-	-	-	■	ms6-frm
	9	-											-
	12	-											-
Durchfluss- sensoren <b>SFAM</b>	4	-											-
	6	-	-	-	-	-	-	-	■	■	-	■	sfam
	9	-											-
	12	-											-

# Wartungseinheiten MSB4/MSB6-FRC, Baureihe MS

Peripherieübersicht

FESTO

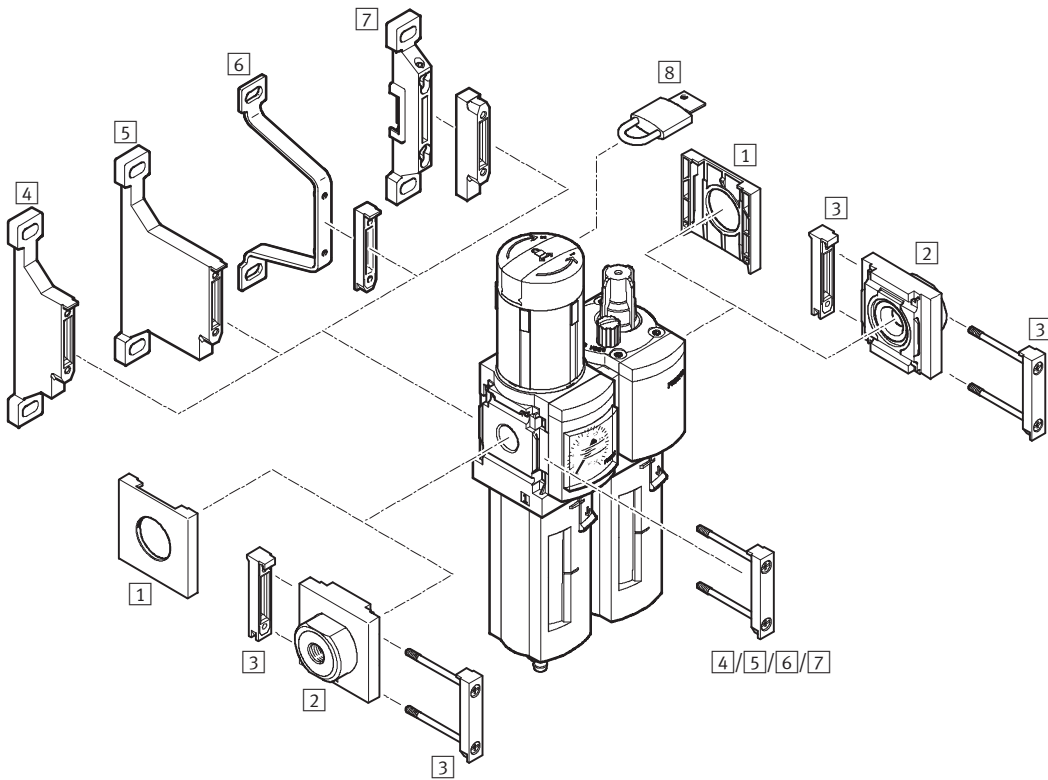

Befestigungselemente und Zubehör		→ Seite/Internet
1	Abdeckkappe MS4/6-END	ms4-end, ms6-end
2	Anschlussplatte MS4/6-AG...	ms4-ag, ms6-ag
3	Modulverbinder MS4/6-MV	ms4-mv, ms6-mv
4	Befestigungswinkel MS4/6-WP	ms4-wp, ms6-wp
5	Befestigungswinkel MS4/6-WPB	ms4-wp, ms6-wp
6	Befestigungswinkel MS4/6-WPE	ms4-wp, ms6-wp
7	Befestigungswinkel MS4/6-WPM	ms4-wp, ms6-wp
8	Bügelverschluss LRVS-D	17



# Wartungseinheiten MSB4/MSB6-FRC, Baureihe MS

Typenschlüssel

MSB 6 - 3/8 - FRC2:J6 M1

## Baureihe

MSB	Wartungseinheit
-----	-----------------

## Baugröße

4	Rastermaß 40 mm
6	Rastermaß 62 mm

## Pneumatischer Anschluss

### MSB4

1/8	Gewinde G1/8
1/4	Gewinde G1/4

### MSB6

1/4	Gewinde G1/4
3/8	Gewinde G3/8
1/2	Gewinde G1/2

## Wartungseinheit bestehend aus:

- Filterregelventil mit Manometer, Drehknopf mit Arretierung, mit Zubehör schließbar
- Öler

## Druckregelbereich 0,3 ... 7 bar

### Kunststoffschutzkorb

FRC3:J7	Filterfeinheit 5 µm, Kondensatablass manuell drehend
FRC4:J8	Filterfeinheit 5 µm, Kondensatablass vollautomatisch
FRC1:J5	Filterfeinheit 40 µm, Kondensatablass manuell drehend
FRC2:J6	Filterfeinheit 40 µm, Kondensatablass vollautomatisch

## Druckregelbereich 0,5 ... 12 bar

### Kunststoffschutzkorb

FRC7:J3	Filterfeinheit 5 µm, Kondensatablass manuell drehend
FRC8:J4	Filterfeinheit 5 µm, Kondensatablass vollautomatisch
FRC5:J1	Filterfeinheit 40 µm, Kondensatablass manuell drehend
FRC6:J2	Filterfeinheit 40 µm, Kondensatablass vollautomatisch

### Metallschale

FRC11:J9	Filterfeinheit 5 µm, Kondensatablass manuell drehend
FRC12:J10	Filterfeinheit 5 µm, Kondensatablass vollautomatisch
FRC9:J11	Filterfeinheit 40 µm, Kondensatablass manuell drehend
FRC10:J12	Filterfeinheit 40 µm, Kondensatablass vollautomatisch

## Öler

M1	Kunststoffschutzkorb
M2	Metallschale

# Wartungseinheiten MSB4/MSB6-FRC, Baureihe MS

FESTO

Datenblatt

mit Kondensatablass  
manuell drehend

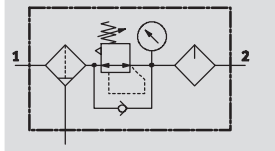

vollautomatisch

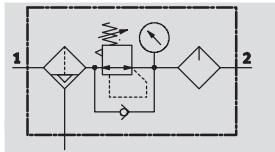

-  - Durchfluss  
800 ... 4 800 l/min

-  - Temperaturbereich  
-10 ... +60 °C

-  - Eingangsdruck  
1,5 ... 20 bar



- Filter-, Regler- und Ölerfunktion in einer Geräteeinheit
- Hoher Durchfluss und Wirkungsgrad der Schmutzabscheidung
- Gute Regelcharakteristik mit kleiner Druck-Hysterese
- Sicherung der Einstellwerte durch Arretierung des Drehknopfes
- Abschließbarer Drehknopf
- Zwei Druckregelbereiche: 0,3 ... 7 bar und 0,5 ... 12 bar
- Wahlweise mit manuellem oder integriertem, vollautomatischem Kondensatablass
- Wahlweise Filtereinsätze 5 µm oder 40 µm
- Neue Filterpatronen → 17, Festo Spezialöl → 17

Allgemeine Technische Daten					
Baugröße	MSB4		MSB6		
Pneumatischer Anschluss 1, 2	G1/8	G1/4	G1/4	G3/8	G1/2
Konstruktiver Aufbau	Filterregler mit Manometer				
	Proportional-Standardnebelöler				
Reglerfunktion	mit Vordruckkompensation				
	mit Sekundärentlüftung				
	mit Rückstromverhalten				
	Ausgangsdruck konstant				
Befestigungsart	mit Zubehör				
Einbaulage	senkrecht ±5°				
Filterfeinheit [µm]	5 (Luftreinheitsklasse am Ausgang 3.7.– nach DIN ISO 8573-1)				
	40 (Luftreinheitsklasse am Ausgang 5.7.– nach DIN ISO 8573-1)				
Schalenschutz	Kunststoffschutzkorb		Kunststoffschutzkorb		
	–		Metallschutzkorb		
Kondensatablass	manuell drehend				
	vollautomatisch				
Betätigungssicherung	Drehknopf mit Arretierung, mit Zubehör schließbar				
Druckregelbereich [bar]	0,3 ... 7				
	0,5 ... 12				
Druckanzeige	mit Manometer				

-||- Hinweis: Dieses Produkt entspricht ISO 1179-1 und ISO 228-1.

# Wartungseinheiten MSB4/MSB6-FRC, Baureihe MS

Datenblatt

Normalnenndurchfluss $q_{nN}^{(1)}$ [l/min]						
Baugröße	MSB4			MSB6		
Pneumatischer Anschluss	G $\frac{1}{8}$	G $\frac{1}{4}$	G $\frac{1}{4}$	G $\frac{3}{8}$	G $\frac{1}{2}$	
Druckregelbereich 0,3 ... 7 bar						
Filterfeinheit	5 $\mu$ m	900	1 300	2 000	4 400	4 600
	40 $\mu$ m	950	1 400	2 100	4 600	4 800
Druckregelbereich 0,5 ... 12 bar						
Filterfeinheit	5 $\mu$ m	800	850	1 700	3 400	3 600
	40 $\mu$ m	850	900	1 900	3 500	3 700

1) Gemessen bei  $p_1 = 10$  bar und  $p_2 = 6$  bar,  $\Delta p = 1$  bar.

Betriebs- und Umweltbedingungen				
Kondensatablass	manuell drehend		vollautomatisch	
Baugröße	MSB4	MSB6	MSB4	MSB6
Eingangsdruck [bar]	1,5 ... 14	1,5 ... 20	1,5 ... 12	1,5 ... 12
Betriebsmedium	Druckluft			
Umgebungstemperatur [°C]	-10 ... +60		+5 ... +60	
Mediumtemperatur [°C]	-10 ... +60		+5 ... +60	
Lagertemperatur [°C]	-10 ... +60		-10 ... +60	
Korrosionsbeständigkeit KBK <sup>1)</sup>	2			

1) Korrosionsbeständigkeitsklasse 2 nach Festo Norm 940 070  
Bauteile mit mäßiger Korrosionsbeanspruchung. Außenliegende sichtbare Teile mit vorrangig dekorativer Anforderung an die Oberfläche, die im direkten Kontakt zur umgebenden industriellen Atmosphäre bzw. Medien, wie Kühl- und Schmierstoffe stehen.

Gewichte [g]		
Baugröße	MSB4	MSB6
mit Kunststoffschutzkorb	500	1 495
mit Metallschutzkorb	–	1 713

## Werkstoffe

Funktionschnitt

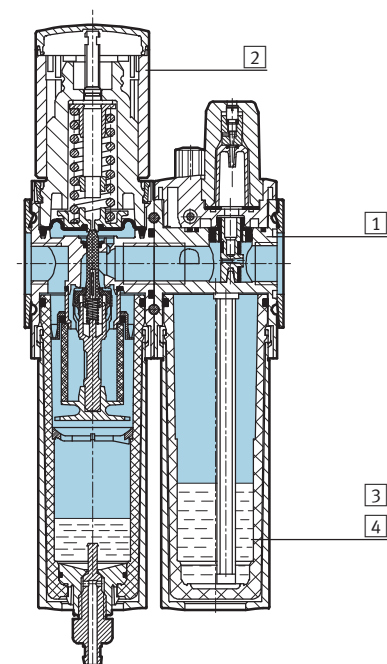

Wartungseinheit		
1	Gehäuse	Alu-Druckguss
2	Reglerknopf	Polyamid/Polyacetal
3	Kunststoffschutzkorb	Polycarbonat
4	Metallschutzkorb	Aluminium-Knetlegierung
–	Dichtungen	Nitrilkautschuk

# Wartungseinheiten MSB4/MSB6-FRC, Baureihe MS

FESTO

Datenblatt

## Normaldurchfluss $q_n$ in Abhängigkeit vom Ausgangsdruck $p_2$

Druckregelbereich 0,3 ... 7 bar

Filterfeinheit 5  $\mu\text{m}$

Filterfeinheit 40  $\mu\text{m}$

MSB4- $\frac{1}{8}$

Primärdruck  $p_1 = 10$  bar

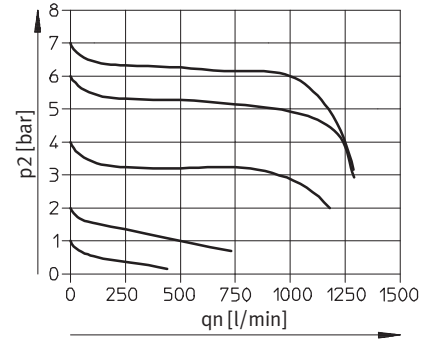
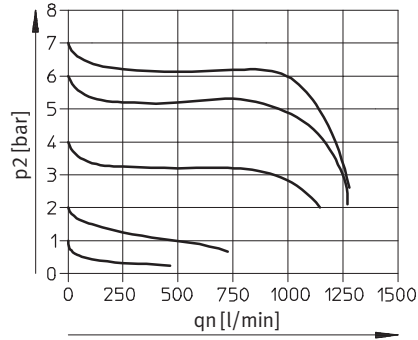

MSB4- $\frac{1}{4}$

Primärdruck  $p_1 = 10$  bar

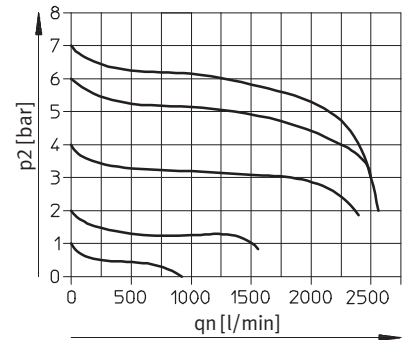
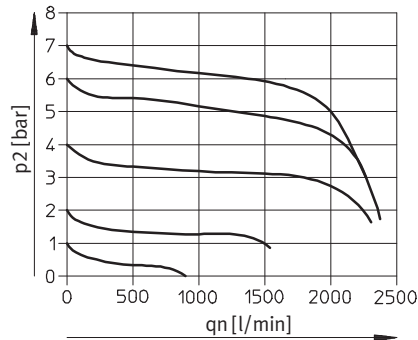

Druckregelbereich 0,5 ... 12 bar

Filterfeinheit 5  $\mu\text{m}$

Filterfeinheit 40  $\mu\text{m}$

MSB4- $\frac{1}{8}$

Primärdruck  $p_1 = 10$  bar

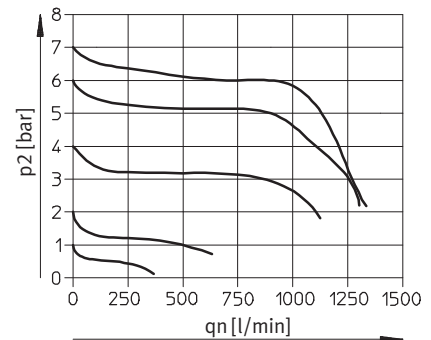
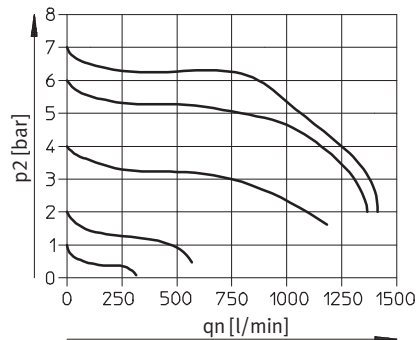

MSB4- $\frac{1}{4}$

Primärdruck  $p_1 = 10$  bar

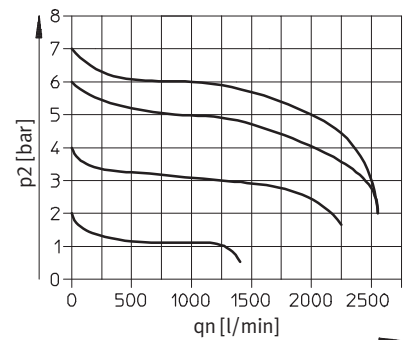
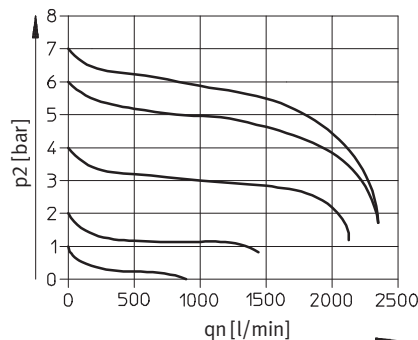

# Wartungseinheiten MSB4/MSB6-FRC, Baureihe MS

Datenblatt

## Normaldurchfluss $q_n$ in Abhängigkeit vom Ausgangsdruck $p_2$

Druckregelbereich 0,3 ... 7 bar

Filterfeinheit 5  $\mu\text{m}$

Filterfeinheit 40  $\mu\text{m}$

MSB6- $\frac{1}{4}$

Primärdruck  $p_1 = 10$  bar

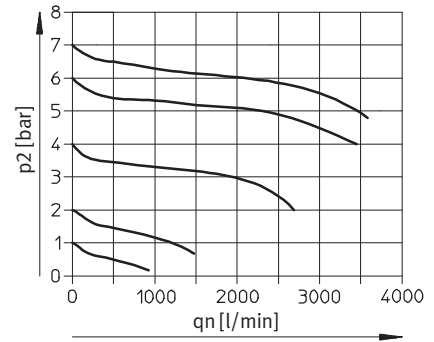
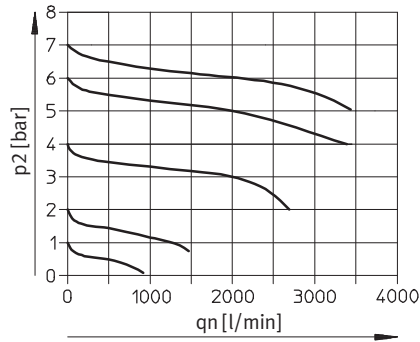

## MSB6- $\frac{3}{8}$

Primärdruck  $p_1 = 10$  bar

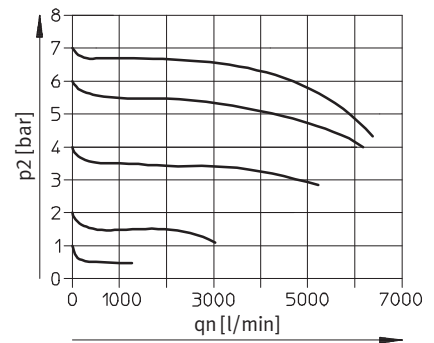
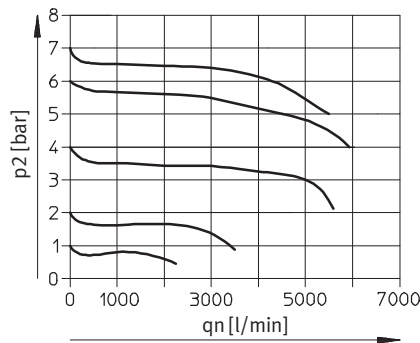

## MSB6- $\frac{1}{2}$

Primärdruck  $p_1 = 10$  bar

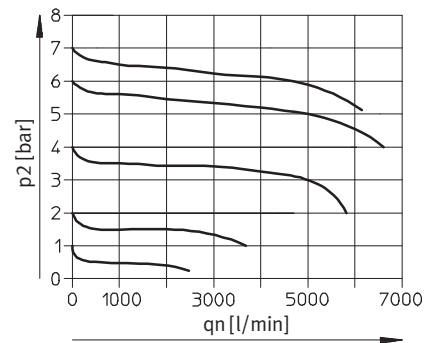
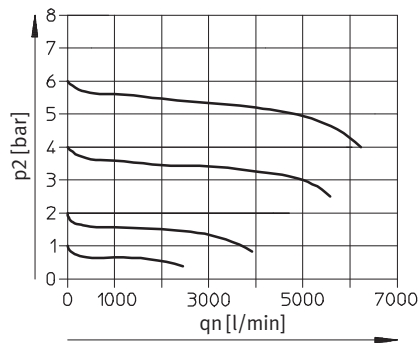

# Wartungseinheiten MSB4/MSB6-FRC, Baureihe MS

Datenblatt

## Normaldurchfluss $q_n$ in Abhängigkeit vom Ausgangsdruck $p_2$

Druckregelbereich 0,5 ... 12 bar

Filterfeinheit 5  $\mu\text{m}$

Filterfeinheit 40  $\mu\text{m}$

MSB6- $\frac{1}{4}$

Primärdruck  $p_1 = 10$  bar

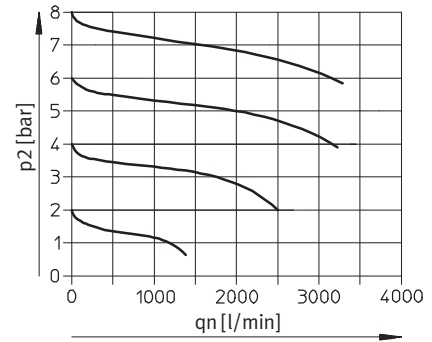
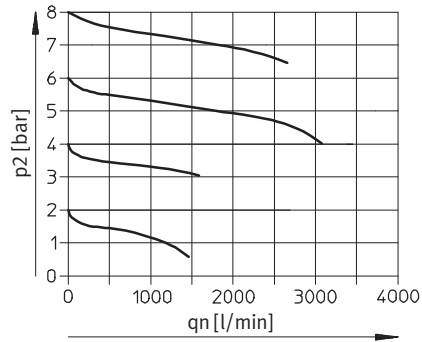

## MSB6- $\frac{3}{8}$

Primärdruck  $p_1 = 10$  bar

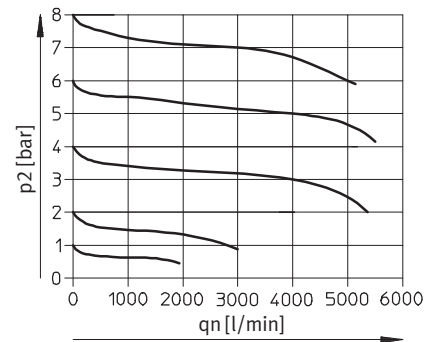
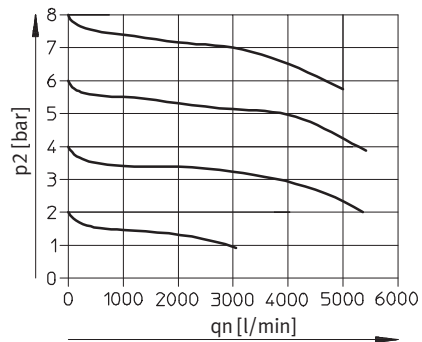

## MSB6- $\frac{1}{2}$

Primärdruck  $p_1 = 10$  bar

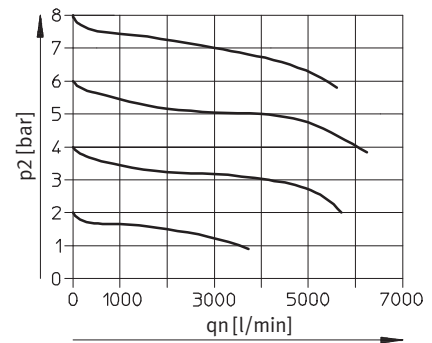
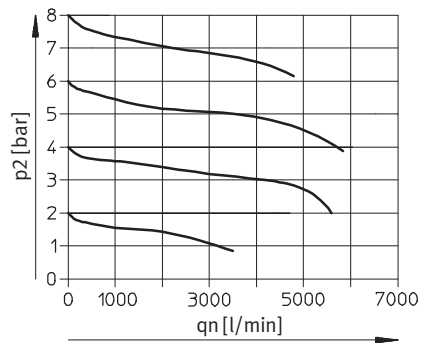

# Wartungseinheiten MSB4/MSB6-FRC, Baureihe MS

Datenblatt

FESTO

## Abmessungen

Download CAD-Daten → [www.festo.com](http://www.festo.com)

mit Manometer, Anzeigeeinheit [bar]

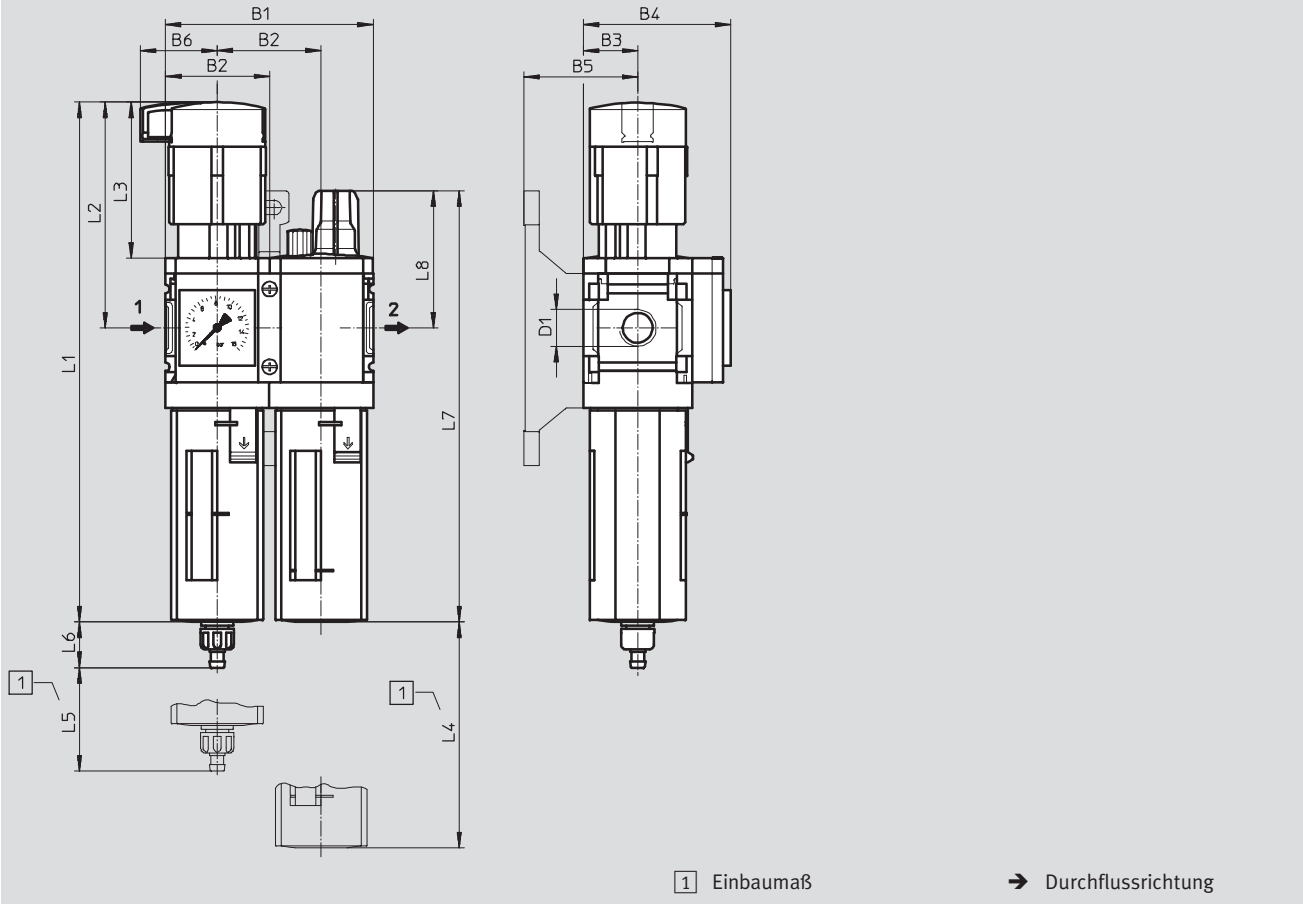

Typ	B1	B2	B3	B4	B5	B6	D1	L1	L2	L3	L4	L5	L6 Kondensatablass		L7	L8
													manuell drehend	vollauto- matisch		
MSB4-1/8	80,4	40,2	21	57	44	29,7	G1/8	201	87	60	80	25	17,7	20,4	167	53
MSB4-1/4							G1/4									
MSB6-1/4	124	62	31	77	54	38,8	G1/4	284,8	134,5	95,5	130	68	15,8	18,5	215,3	65,6
MSB6-3/8							G3/8									
MSB6-1/2							G1/2									

· | · Hinweis: Dieses Produkt entspricht ISO 1179-1 und ISO 228-1.

# Wartungseinheiten MSB4/MSB6-FRC, Baureihe MS

FESTO

Datenblatt

Bestellangaben						
Druckregelbereich 0,3 ... 7 bar						
Baugröße	Kondensatablass	Anschluss	Filterfeinheit 5 µm		Filterfeinheit 40 µm	
			Teile-Nr.	Typ	Teile-Nr.	Typ
Kunststoffschutzkorb						
MSB4	manuell drehend	G $\frac{1}{8}$	531129	MSB4- $\frac{1}{8}$ -FRC3:J7M1	531125	MSB4- $\frac{1}{8}$ -FRC1:J5M1
		G $\frac{1}{4}$	531113	MSB4- $\frac{1}{4}$ -FRC3:J7M1	531109	MSB4- $\frac{1}{4}$ -FRC1:J5M1
	vollautomatisch	G $\frac{1}{8}$	531131	MSB4- $\frac{1}{8}$ -FRC4:J8M1	531127	MSB4- $\frac{1}{8}$ -FRC2:J6M1
		G $\frac{1}{4}$	531115	MSB4- $\frac{1}{4}$ -FRC4:J8M1	531111	MSB4- $\frac{1}{4}$ -FRC2:J6M1
MSB6	manuell drehend	G $\frac{1}{4}$	530264	MSB6- $\frac{1}{4}$ -FRC3:J7M1	530254	MSB6- $\frac{1}{4}$ -FRC1:J5M1
		G $\frac{3}{8}$	530288	MSB6- $\frac{3}{8}$ -FRC3:J7M1	530278	MSB6- $\frac{3}{8}$ -FRC1:J5M1
		G $\frac{1}{2}$	530240	MSB6- $\frac{1}{2}$ -FRC3:J7M1	530230	MSB6- $\frac{1}{2}$ -FRC1:J5M1
	vollautomatisch	G $\frac{1}{4}$	530266	MSB6- $\frac{1}{4}$ -FRC4:J8M1	530262	MSB6- $\frac{1}{4}$ -FRC2:J6M1
		G $\frac{3}{8}$	530290	MSB6- $\frac{3}{8}$ -FRC4:J8M1	530286	MSB6- $\frac{3}{8}$ -FRC2:J6M1
		G $\frac{1}{2}$	530242	MSB6- $\frac{1}{2}$ -FRC4:J8M1	530238	MSB6- $\frac{1}{2}$ -FRC2:J6M1

Bestellangaben						
Druckregelbereich 0,5 ... 12 bar						
Baugröße	Kondensatablass	Anschluss	Filterfeinheit 5 µm		Filterfeinheit 40 µm	
			Teile-Nr.	Typ	Teile-Nr.	Typ
Kunststoffschutzkorb						
MSB4	manuell drehend	G $\frac{1}{8}$	531137	MSB4- $\frac{1}{8}$ -FRC7:J3M1	531133	MSB4- $\frac{1}{8}$ -FRC5:J1M1
		G $\frac{1}{4}$	531121	MSB4- $\frac{1}{4}$ -FRC7:J3M1	531117	MSB4- $\frac{1}{4}$ -FRC5:J1M1
	vollautomatisch	G $\frac{1}{8}$	531139	MSB4- $\frac{1}{8}$ -FRC8:J4M1	531135	MSB4- $\frac{1}{8}$ -FRC6:J2M1
		G $\frac{1}{4}$	531123	MSB4- $\frac{1}{4}$ -FRC8:J4M1	531119	MSB4- $\frac{1}{4}$ -FRC6:J2M1
MSB6	manuell drehend	G $\frac{1}{4}$	530272	MSB6- $\frac{1}{4}$ -FRC7:J3M1	530268	MSB6- $\frac{1}{4}$ -FRC5:J1M1
		G $\frac{3}{8}$	530296	MSB6- $\frac{3}{8}$ -FRC7:J3M1	530292	MSB6- $\frac{3}{8}$ -FRC5:J1M1
		G $\frac{1}{2}$	530248	MSB6- $\frac{1}{2}$ -FRC7:J3M1	530244	MSB6- $\frac{1}{2}$ -FRC5:J1M1
	vollautomatisch	G $\frac{1}{4}$	530274	MSB6- $\frac{1}{4}$ -FRC8:J4M1	530270	MSB6- $\frac{1}{4}$ -FRC6:J2M1
		G $\frac{3}{8}$	530298	MSB6- $\frac{3}{8}$ -FRC8:J4M1	530294	MSB6- $\frac{3}{8}$ -FRC6:J2M1
		G $\frac{1}{2}$	530250	MSB6- $\frac{1}{2}$ -FRC8:J4M1	530246	MSB6- $\frac{1}{2}$ -FRC6:J2M1

Metallschale						
MSB6	manuell drehend	G $\frac{1}{4}$	530258	MSB6- $\frac{1}{4}$ -FRC11:J9M2	530276	MSB6- $\frac{1}{4}$ -FRC9:J11M2
		G $\frac{3}{8}$	530282	MSB6- $\frac{3}{8}$ -FRC11:J9M2	530300	MSB6- $\frac{3}{8}$ -FRC9:J11M2
		G $\frac{1}{2}$	530234	MSB6- $\frac{1}{2}$ -FRC11:J9M2	530252	MSB6- $\frac{1}{2}$ -FRC9:J11M2
	vollautomatisch	G $\frac{1}{4}$	530260	MSB6- $\frac{1}{4}$ -FRC12:J10M2	530256	MSB6- $\frac{1}{4}$ -FRC10:J12M2
		G $\frac{3}{8}$	530284	MSB6- $\frac{3}{8}$ -FRC12:J10M2	530280	MSB6- $\frac{3}{8}$ -FRC10:J12M2
		G $\frac{1}{2}$	530236	MSB6- $\frac{1}{2}$ -FRC12:J10M2	530232	MSB6- $\frac{1}{2}$ -FRC10:J12M2



# Wartungseinheiten MSB-FRC, Baureihe MS

Zubehör

**FESTO**

## Filterpatronen



Bestellangaben			
Baugröße	Filterfeinheit [µm]	Teile-Nr.	Typ
MS4	5 (Farbe: blau)	534501	MS4-LFP-C
	40 (Farbe: weiß)	534502	MS4-LFP-E
MS6	5 (Farbe: blau)	534499	MS6-LFP-C
	40 (Farbe: weiß)	534500	MS6-LFP-E

## Spezialöl



Bestellangaben			
Lieferumfang		Teile-Nr.	Typ
1 Liter		152811	OFSW-32

Bestellangaben – Bügelschloss LRVS-D			
	Gewicht [g]	Teile-Nr.	Typ
	120	193786	LRVS-D