

Proportional directional control valves VPWP



Proportional directional control valves VPWP

Overview

Servo-pneumatic drive technology

Positioning and Soft Stop applications as an integral component of the valve terminal CPX – the modular peripheral system for decentralised automation tasks.

The modular design means that valves, digital inputs and outputs, positioning modules and end-position controllers, as appropriate to the application, can be combined in almost any way on the CPX terminal.

Advantages:

- Pneumatics and electrics – control and positioning on one platform
- Innovative positioning technology – piston rod drives, rodless drives, rotary drives
- Actuation via fieldbus
- Remote maintenance, remote diagnostics, web server, SMS and e-mail alert are all possible via TCP/IP
- Modules can be quickly exchanged and expanded without altering the wiring

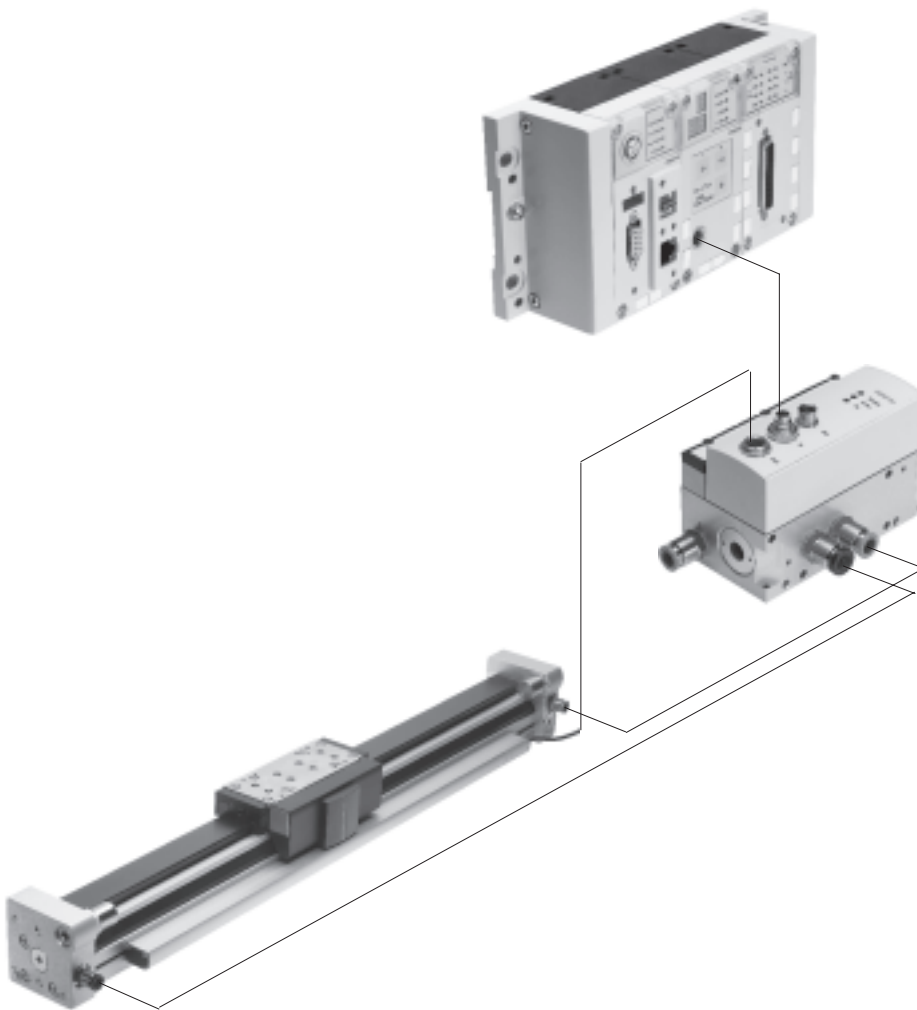

Proportional directional control valves VPWP

Key features

Axis controller CPX-CMAX



Free choice:
Position and force control, directly actuated or selected from one of 64 configurable position sets.
Looking for something more:
The configurable function for switching to the next set enables simple functional sequences to be realised in the axis controller CPX-CMAX.
Everything is recognisable:
The auto-identification function identifies each station with its device data on the controller CPX-CMAX.

Also included:
The functional scope of the controller CPX-CMAX includes actuation of a brake or clamping unit via the proportional directional control valve VPWP.
Up to 7 modules (max. 7 axes) can be operated in parallel and independently of each other.
Commissioning via FCT (Festo configuration software) or via fieldbus: no programming, only configuring.

Technical data → Internet: [cpx-cmax](#)

Advantages:

- Greater flexibility
- OEM friendly – commissioning also via fieldbus
- Clear installation and fast commissioning
- Cost effective
- You program the system in your PLC environment

End-position controller CPX-CMPX



Fast travel between the mechanical end stops of the cylinder, stopping gently and without impact in the end position.
Fast commissioning via control panel, fieldbus or handheld unit.
Improved downtime regulation.
Actuation of a brake or clamping unit via the proportional directional control valve VPWP is an integral component of the controller CMPX.

Depending on the fieldbus chosen, up to 9 end-position controllers can be actuated on the CPX terminal. All system data can be read and written via the fieldbus, for example the mid positions also.

Technical data → Internet: [cpx-cmpx](#)

Advantages:

- Greater flexibility
- OEM friendly – commissioning also via fieldbus
- Clear installation and fast commissioning
- Cost-effective
 - Up to 30% faster cycle rates
 - Significantly reduced system vibration
- Improved work ergonomics thanks to significantly reduced noise level
- The extended diagnostics help to reduce the service time of the machine

Proportional directional control valve VPWP

Technical data → 7



The 5/3-way proportional directional control valve for applications with Soft Stop and pneumatic positioning.
Fully digitalised – with integrated pressure sensors, with new diagnostic functions.
In sizes 4, 6 and 8.
Flow rate from 350, 700 and 1,400 l/min.

With switching output for actuating a brake.
Coloured supply ports.
Pre-assembled cables guarantee faultless and fast connection with the controllers CPX-CMPX and CPX-CMAX.

Advantages:

- Clear installation and fast commissioning
- Reduction of system downtimes thanks to the new diagnostic options
- With switching output for actuating a brake/clamping unit

Proportional directional control valves VPWP

Drive options

FESTO

System with linear drive DGCI

Technical data → Internet: dgci

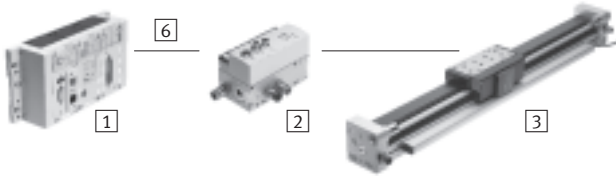

- 1 Controller module CPX-CMPX or CPX-CMAX
- 2 Proportional directional control valve VPWP
- 3 Linear drive DGCI with displacement encoder
- 6 Connecting cable KVI-CP-3-...

- Pneumatic rodless linear drive with displacement encoder and recirculating ball bearing guide
- Displacement encoder with absolute and contactless measuring
- Identically constructed with pneumatic linear drive DGC
- Diameter: 18 ... 40 and 63 mm
- Stroke: 100 ... 2,000 mm in fixed lengths
- Range of application: Soft Stop and pneumatic positioning of loads from 1 ... 180 kg
- No sensor interface required

Advantages:

- Finished drive unit, precision guide
- Excellent running characteristics
- For fast and accurate positioning down to ± 0.2 mm (only with axis controller CPX-CMAX)

System with standard cylinder DNCI

Technical data → Internet: dncl

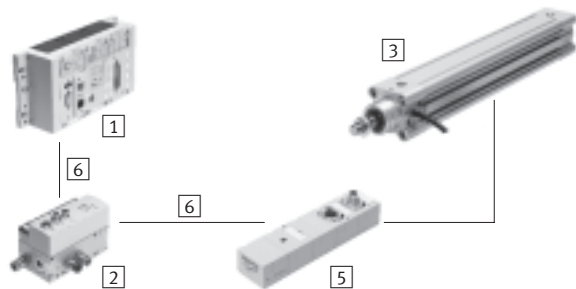

- 1 Controller module CPX-CMPX or CPX-CMAX
- 2 Proportional directional control valve VPWP
- 3 Standard cylinder DNCI with displacement encoder
- 5 Sensor interface CASM-S-D3-R7
- 6 Connecting cable KVI-CP-3-...

- Standard cylinder with integrated displacement encoder, conforms to DIN ISO 6432, VDMA 24 562, NFE 49 003.1 and Uni 10 290
- Displacement encoder with contactless and incremental measuring
- Diameter: 32 ... 63 mm
- Stroke: (10) 100 ... 500 (2,000) mm
- Range of application: Soft Stop and pneumatic positioning: loads from 3 ... 180 kg and the matching sensor interface CASM-S-D3-R7
- Pre-assembled cables guarantee faultless and fast electrical connection

Advantages:

- Compact drive unit
- Universal applications
- Also with guide unit
- For fast and accurate positioning down to ± 0.3 mm (only with axis controller CPX-CMAX)

Proportional directional control valves VPWP

Drive options

System with swivel module DSMI

Technical data → Internet: [dsmi](#)

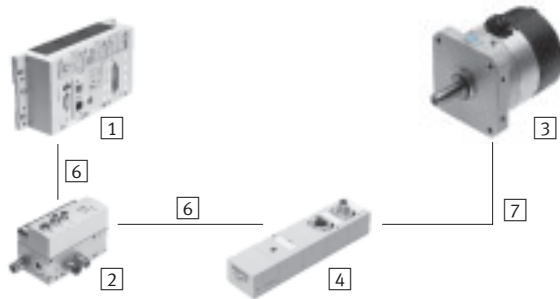

- 1 Controller module CPX-CMPX or CPX-CMAX
- 2 Proportional directional control valve VPWP
- 3 Swivel module DSMI with displacement encoder
- 4 Sensor interface CASM-S-D2-R3
- 6 Connecting cable KVI-CP-3-...
- 7 Connecting cable NEBC-P1W4-K-0,3-N-M12G5

- Swivel module DSMI with integrated displacement encoder
- Identically constructed with pneumatic swivel module DSM
- Absolute displacement encoder on basis of potentiometer
- Swivel range from 0 ... 270°
- Size: 25 and 40
- Max. torque: 5 or 20 Nm
- Range of application: Soft Stop and pneumatic positioning: mass moments of inertia from 15 ... 1,200 kgcm² and the matching sensor interface CASM-S-D2-R3
- Pre-assembled cables guarantee faultless and fast connection with the proportional directional control valve VPWP

Advantages:

- Finished drive unit, compact, can be used immediately
- High angular acceleration
- With adjustable fixed stops
- For fast and accurate positioning down to ±0.2° (only with axis controller CPX-CMAX)

System with potentiometer

Technical data → Internet: [casm](#)

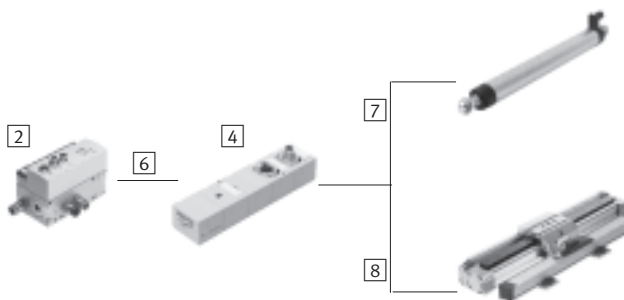

- 2 Proportional directional control valve VPWP
- 4 Sensor interface CASM-S-D2-R3
- 6 Connecting cable KVI-CP-3-...
- 7 Connecting cable NEBC-P1W4-K-0,3-N-M12G5
- 8 Connecting cable NEBC-A1W3-K-0,4-N-M12G5

- Attachable potentiometers with absolute measurement, with high degree of protection
- With connecting rod or moment compensator
- Measuring range: 100 ... 2,000 mm
- Pre-assembled cables guarantee faultless and fast connection with the sensor interface CASM
- Range of application: Soft Stop and pneumatic positioning with cylinder Ø 18 ... 80 mm, loads from 1 ... 300 kg

Advantages:

- Clear installation and fast commissioning
- Cost effective
- Can also be used in harsh environmental conditions
- Variety in the drives: CPX-CMPX and CPX-CMAX also support cylinders with external displacement encoder

Proportional directional control valves VPWP

Drive options

System components for Soft Stop systems with end-position controller CPX-CMPX							
3		Linear drive DGCI	Standard cylinder DNCI	Swivel module DSMI	Potentiometer LWG	Potentiometer TLF	→ Page/Internet
1	End-position controller CPX-CMPX	■	■	■	■	■	cpx-cmpx
2	Proportional directional control valve VPWP	■	■	■	■	■	7
4	Sensor interface CASM-S-D2-R3	-	-	■	■	■	casm
5	Sensor interface CASM-S-D3-R7	-	■	-	-	-	casm
6	Connecting cable KVI-CP-3-...	■	■	■	■	■	14
7	Connecting cable NEBC-P1W4-...	-	-	■	■	-	nebc
8	Connecting cable NEBC-A1W3-...	-	-	-	-	■	nebc

System components for pneumatic positioning systems with axis controller CPX-CMAX							
3		Linear drive DGCI	Standard cylinder DNCI	Swivel module DSMI	Potentiometer LWG	Potentiometer TLF	→ Page/Internet
1	Axis controller CPX-CMAX	■	■	■	■	■	cpx-cmax
2	Proportional directional control valve VPWP	■	■	■	■	■	7
4	Sensor interface CASM-S-D2-R3	-	-	■	■	■	casm
5	Sensor interface CASM-S-D3-R7	-	■	-	-	-	casm
6	Connecting cable KVI-CP-3-...	■	■	■	■	■	14
7	Connecting cable NEBC-P1W4-...	-	-	■	■	-	nebc
8	Connecting cable NEBC-A1W3-...	-	-	-	-	■	nebc

Proportional directional control valves VPWP

Type codes

		VPWP	6	L	5	Q6	10	E	F
Series									
VPWP	Proportional directional control valve								
Nominal size									
Valve type									
L	In-line valve								
Valve function									
5	5/3-way valve								
Pneumatic connection									
Q6	Push-in fitting 6 mm								
Q8	Push-in fitting 8 mm								
Q10	Push-in fitting 10 mm								
Q	Thread without fitting								
Pressure range									
10	0 ... 10 bar								
Type of display									
E	LED only								
Exhaust									
D	Ducted exhaust air								
F	Flat plate silencer								
G	Thread without fitting								

Proportional directional control valves VPWP

Peripherals overview

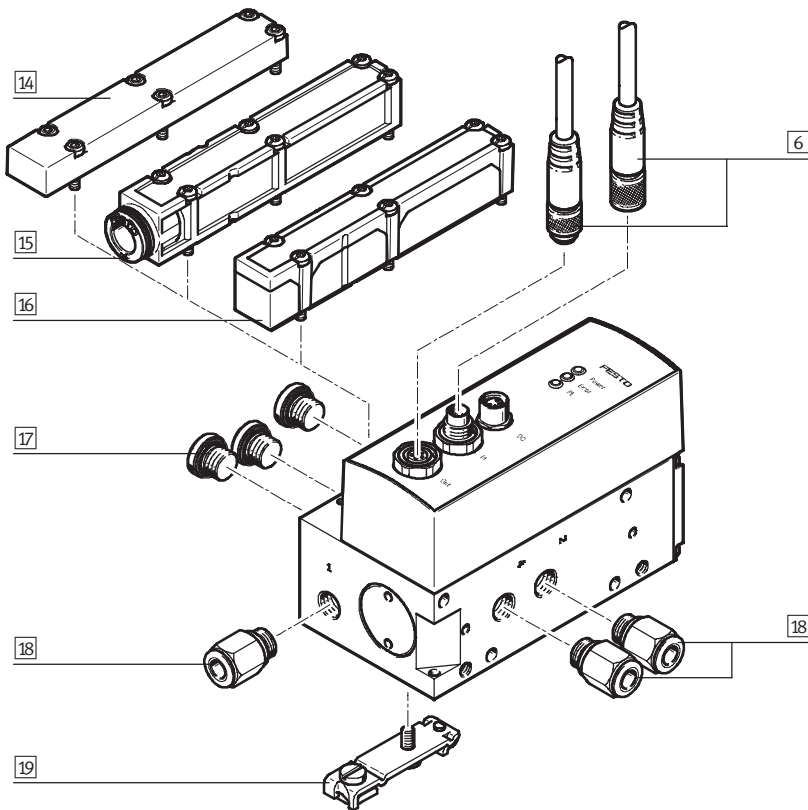





Accessories		Brief description	→ Page/Internet
6	Connecting cable KVI-CP-3	For connecting proportional directional control valve VPWP to the end-position controller CPX-CMPX/axis controller CPX-CMAX or to the sensor interface CASM	14
14	Blanking plate VABB-P3-1	For using the connections on the cover plate	14
15	Plate VMPA-AP	For ducted exhaust air	14
16	Plate VMPA-APU	With flat plate silencer	14
17	Blanking plug B	For sealing the exhaust ports on the cover plate	blanking plug
18	Push-in fitting QS	<ul style="list-style-type: none"> • Different coloured push-in fittings, for simple and error-free tubing • For connecting compressed air tubing with standard outside diameter 	14
19	Mounting CPASC1-BG, CPV10/14-VI-BG	For mounting on a H-rail	14

Proportional directional control valves VPWP

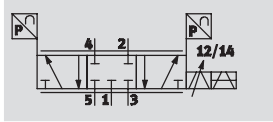
Technical data

Function



-  Voltage
24 V DC
-  Flow rate
350 ... 1,400 l/min
-  Pressure
0 ... 10 bar



General technical data				
Nominal size		4	6	8
Pneumatic connection		G1/8		G1/4
Nominal size	[mm]	4	6	8
Standard nominal flow rate	[l/min]	350	700	1,400
Valve function		5/3-way proportional directional control valve, closed		
Constructional design		Piston spool with integrated pressure sensors		
Sealing principle		Hard		
Actuation type		Electric		
Reset method		Magnetic spring		
Type of control		Direct		
Direction of flow		Non-reversible		
Type of mounting		<ul style="list-style-type: none"> - Direct mounting via through-holes - Via H-rail 		
Assembly position ¹⁾		Preferably horizontal (display elements facing upwards)		
Product weight	[g]	780	780	1,060
Pressure sensors				
Repetition accuracy FS	[%]	< 1		
Pressure resolution	[bar]	0.01		
Linearity error FS ²⁾	[%]	< 1.5		
Diagnostics				
LED indicators	Green	Nominal operating voltage		
	Red	Error		
	Yellow	Load voltage		
Device-specific diagnostics via control interface		<ul style="list-style-type: none"> - Undervoltage with operating and load voltage - Temperature monitoring - Valve sticking - Short-circuit monitoring - Device data 		
Control interface				
Data		CAN bus with Festo protocol		
		Digital		
		Integrated terminating resistor		
Electrical connection		5-pin		
		M9		
		Plug		

1) If the proportional directional control valve moves during operation, it must be mounted at right angles to the direction of movement

2) Referred to 6 bar

Proportional directional control valves VPWP

Technical data

Electrical data		
Load supply		
Operating voltage range	[V DC]	18 ... 30
Nominal operating voltage	[V DC]	24
Load voltage range	[V DC]	18 ... 30
Nominal load voltage	[V DC]	24
Residual ripple	[Vss]	4
Max. current consumption (logic)	[A]	0.15
Max. current consumption (valve drive)	[A]	1.2
Power supply requirement		PELV (Protected Extra-Low Voltage)
Safety note		The valve assumes the closed mid position if there is a problem with the control interface
Digital output (plug DO, PIN2)		
Supply voltage	[V DC]	24 (coming from load voltage)
Max. load current	[mA]	500
Characteristics		<ul style="list-style-type: none"> – Positive logic (PNP) to IEC 61131-2 – No electrical isolation – Protected against short circuits – Reverse supply with no damage
Voltage output (plug DO, PIN4)		
Supply voltage	[V DC]	24 (coming from load voltage)
Max. load current	[mA]	500
Characteristics		<ul style="list-style-type: none"> – Positive logic (PNP) to IEC 61131-2 – No electrical isolation – Protected against short circuits – Reverse supply with no damage

Operating and environmental conditions		
Operating medium		Filtered compressed air, unlubricated, grade of filtration 5 µm
Operating pressure	[bar]	0 ... 10
Nominal operating pressure	[bar]	6
Ambient temperature	[°C]	0 ... 50
Temperature of medium	[°C]	0 ... 50
Storage temperature	[°C]	-20 ... +70
CE mark (see declaration of conformity)		To EU EMC Directive
Protection class ¹⁾		IP65
Vibration resistance to DIN/IEC 68, Part 2-6		With wall mounting: tested to severity level 2 With H-rail mounting: tested to severity level 1
Continuous shock resistance to DIN/IEC 68, Part 2-27		With wall mounting: tested to severity level 2 With H-rail mounting: tested to severity level 1

1) In assembled state, with plug, at nominal pressure and with tubing connected
 2) For brake or clamping unit

Pin allocation

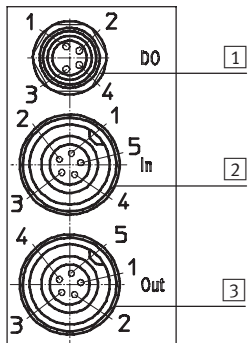

Diagram 1: DO, 4-pin M8 socket. Pins 1, 2, 3, 4.

Diagram 2: In, 5-pin M9 plug. Pins 1, 2, 3, 4, 5.

Diagram 3: Out, 5-pin M9 socket. Pins 1, 2, 3, 4, 5.

1 DO, 4-pin M8 socket	
Pin	Function
1	–
2	Digital output
3	0 V
4	24 V voltage output
–	
–	

2 IN, 5-pin M9 plug	
Pin	Function
1	24 V operating voltage
4	24 V load voltage
3	0 V
4	CAN_H
5	CAN_L
–	FE

3 OUT, 5-pin M9 socket	
Pin	Function
1	24 V operating voltage
2	24 V load voltage
3	0 V
4	CAN_H
5	CAN_L
–	FE

Proportional directional control valves VPWP

Technical data

Flow rate q_{mN} as a function of digital actuation v_c * [100%]

Nominal size 4

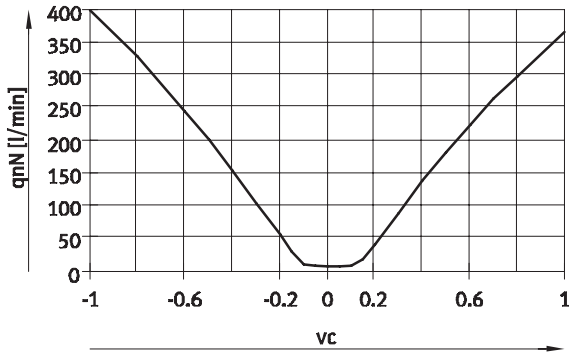

Nominal size 6

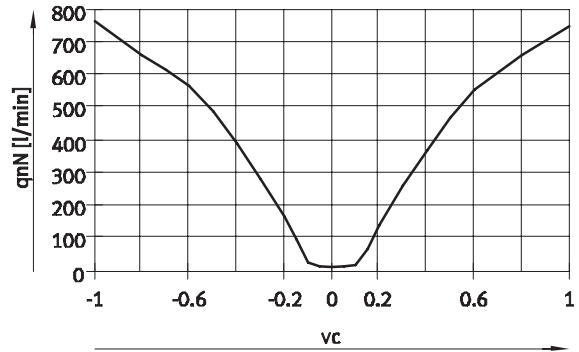

Nominal size 8

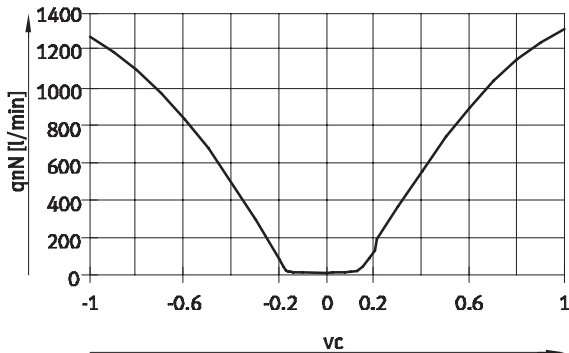

Materials

Sectional view

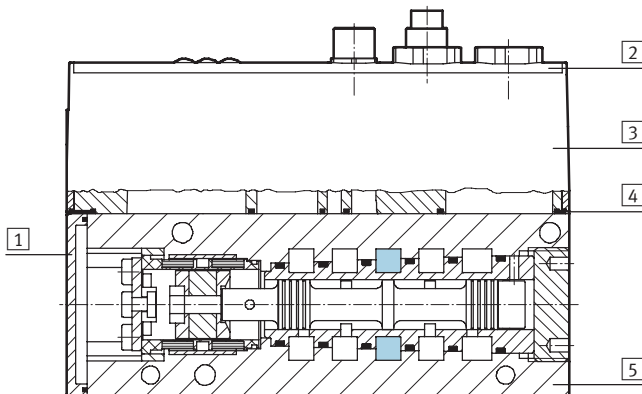

Proportional directional control valve

1	Cap	Reinforced polyamide
2	Inscription panel	Polyester
3	Electronics housing	Reinforced polyamide
4	Seals	Nitrile rubber
5	Valve housing	Anodised wrought aluminium alloy

Proportional directional control valves VPWP

Technical data

Dimensions

Download CAD data → www.festo.com

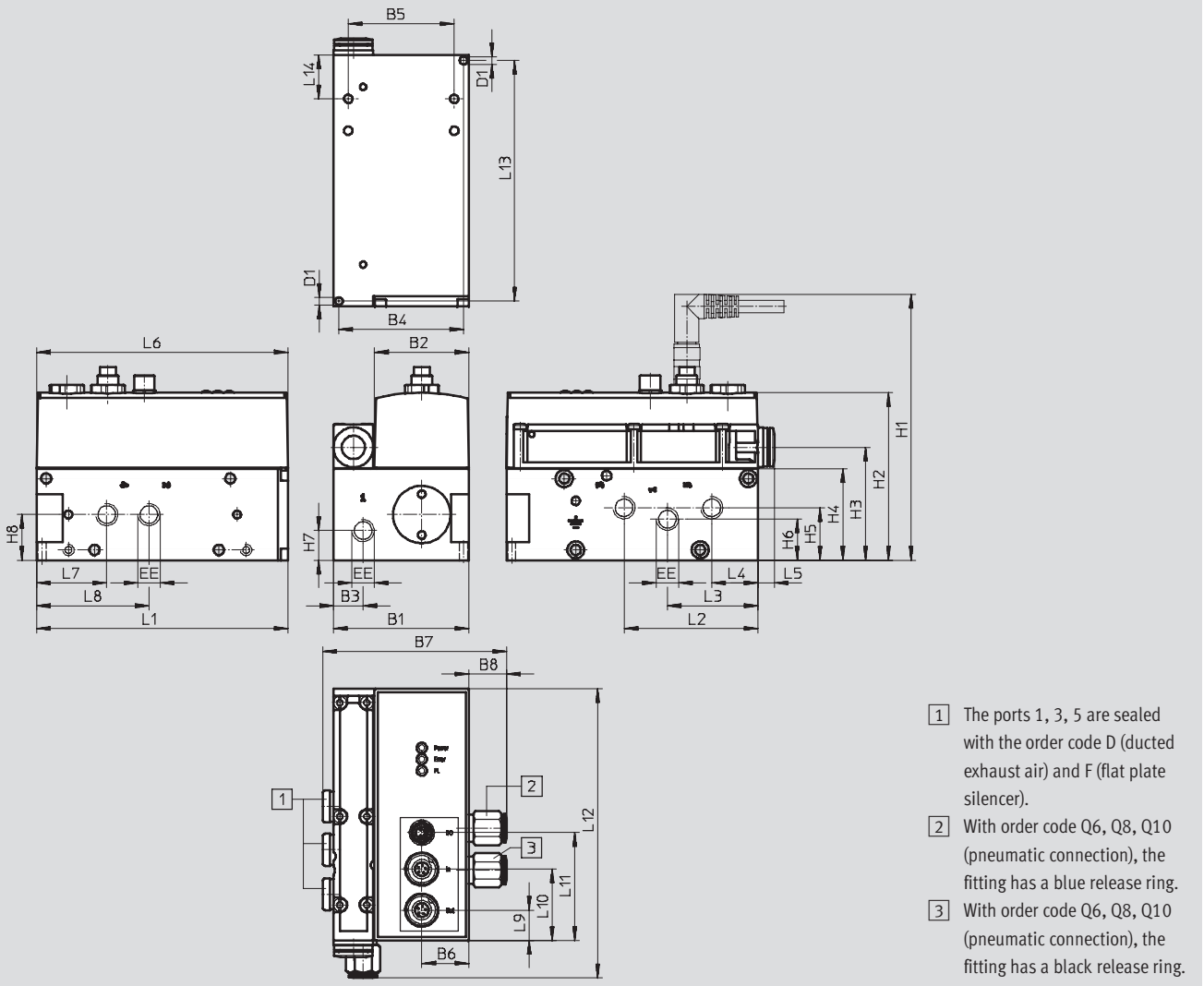

Nominal size	B1	B2	B3	B4	B5	B6	B7		B8		D1 ∅
							Q6	Q8	Q6	Q8	
4	59.5	41.5	13	54.7	46.5	20.75	80.4	85.6	16.4	21.6	3.4
6				64.5	56.5		85.6	85.6	21.6	21.6	
8				69.5	64.5		56.5	98.6	98.6	24.1	

Nominal size	EE	H1 ¹⁾	H2	H3 ²⁾	H4	H5	H6	H7	H8	L1	L2
4	G ¹ / ₈	approx. 116/124	73.5	50	40	23	18	13	20	110.4	58.8
6			81.5	58	48	28	22	15.5	24	122.3	67.6
8			approx. 124/132	81.5	58	48	28	22	15.5	24	122.3

Nominal size	L3	L4	L5 ²⁾	L6	L7	L8	L9	L10	L11	L12	L13	L14
4	39.8	20.3	7.2	110.4	30.8	49.3	13.3	31.3	47.3	132	105.6	19.3
6					34	56.4				146.5	117.3	22.5
8					45.2	22.8				-	34	56.4

1) Angled plug/straight plug
 2) Only with variant D

Proportional directional control valves VPWP

Ordering data – Modular products

Ordering table						
Size	4	6	8	Condi- tions	Code	Enter code
M Module No.	550170	550171	550172			
Series	Proportional directional control valve				VPWP	VPWP
Nominal size	4	–	–		-4	
	–	6	–		-6	
	–	–	8		-8	
Valve type	In-line valve				-L	-L
Valve function	5/3-way valve				-5	-5
Pneumatic connection	Push-in fitting 6 mm	–	–		-Q6	
	Push-in fitting 8 mm	–	–		-Q8	
	–	–	Push-in fitting 10 mm		-Q10	
	Thread without fitting G $\frac{1}{8}$	G $\frac{1}{8}$	G $\frac{1}{4}$		-Q	
Pressure range	0 ... 10 bar				-10	-10
Indicator type	LED only				-E	-E
Exhaust	Ducted exhaust air QSIK-S-10 QSIK-S-10 QSIK-S-10				-D	
	Flat plate silencer				-F	
	Thread without fitting G $\frac{1}{8}$	G $\frac{1}{8}$	G $\frac{1}{4}$		-G	

Transfer order code

	VPWP	-		-	L	-	5	-		-	10	-	E	-	
--	-------------	---	--	---	----------	---	----------	---	--	---	-----------	---	----------	---	--

Proportional directional control valves VPWP

Accessories

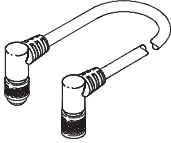
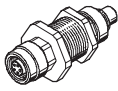
Ordering data – Connecting cables				
	Brief description	Cable length [m]	Part No.	Type
Connection between axis controller CPX-CMAX/end-position controller CPX-CMPX and proportional directional control valve VPWP or between proportional directional control valve VPWP and sensor interface CASM				
	Angled plug and angled socket	0.25	540 327	KVI-CP-3-WS-WD-0,25
		0.5	540 328	KVI-CP-3-WS-WD-0,5
		2	540 329	KVI-CP-3-WS-WD-2
		5	540 330	KVI-CP-3-WS-WD-5
		8	540 331	KVI-CP-3-WS-WD-8
	Straight plug and straight socket	2	540 332	KVI-CP-3-GS-GD-2
		5	540 333	KVI-CP-3-GS-GD-5
		8	540 334	KVI-CP-3-GS-GD-8
	Connector for control cabinet through-feed	–	543 252	KVI-CP-3-SSD

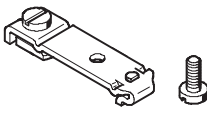
Ordering data – Mountings			
	Brief description	Part No.	Type
	For nominal size 4 and 6	527 392	CPASC1-BG-NGH
	For nominal size 8	162 556	CPV10/14-VI-BG-RH-35

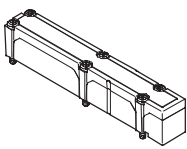
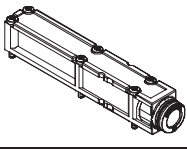
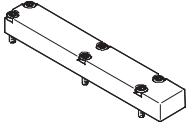
Ordering data – Exhaust variants			
	Brief description	Part No.	Type
	Plate with flat plate silencer	533 374	VMPA-APU
	Plate for ducted exhaust air	533 375	VMPA-AP
	Blanking plate, for using the connections on the valve block directly, for example for a silencer	563 896	VABB-P3-1

Ordering data – Push-in fittings			
	Nominal size	Part No.	Type
	Ports 2 and 4		
	4	186 096	QS-G $\frac{1}{8}$ -6
	4, 6	186 098	QS-G $\frac{1}{8}$ -8
	8	186 101	QS-G $\frac{1}{4}$ -10
	Port 1		
	4, 6	186 098	QS-G $\frac{1}{8}$ -8
	8	186 101	QS-G $\frac{1}{4}$ -10