

Ball valves VAPB, VZBA





Ball valves VAPB, VZBA, mechanically actuated

Key features and product range overview

Brief description

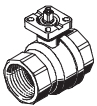
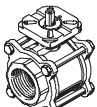
- 2 and 3-part designs
- Connecting thread to DIN 2999 or DIN ISO 228-1
- Mounting flange to ISO 5211
- Length to DIN 3202-M3
- Corrosion and acid resistant designs
- Blow-out proof shaft assembled from inside
- Housing made of brass and high grade-steel
- Ball valves capable of being automated

Function	Version	Type	Connection valve ¹⁾	Internal dia. [mm]	Flange hole pattern to ISO 5211	Max. operating pressure [bar]	→ Page/Internet
Ball valve 2-way	Brass						
		VAPB	Rp1/4	15	F03	40	4
			Rp3/8	15	F03	40	
			Rp1/2	15	F03	40	
			Rp3/4	20	F03	40	
			Rp1	25	F0304	40	
			Rp1 1/4	32	F0405	40	
			Rp1 1/2	40	F0405	25	
			Rp2	50	F05	25	
			Rp2 1/2	63	F07	25	
	Stainless steel, corrosion-resistant						
		VAPB-...-CR	Rp1/4	15	F0304	63	7
			Rp3/8	15	F0304		
			Rp1/2	15	F0304		
			Rp3/4	20	F0304		
			Rp1	25	F0405		
			Rp1 1/4	32	F0405		
			Rp1 1/2	40	F0507		
			Rp2	50	F0507		
			Rp2 1/2	63	F0710		
Rp3			80	F0710			
Rp4	100	F10					
Ball valve 3-way	Stainless steel, corrosion-resistant						
		VZBA	Rp1/4	11.6	F0304	63	11
			Rp3/8	12.5	F0304		
			Rp1/2	12.5	F0304		
			Rp3/4	15	F0405		
			Rp1	20	F0405		
			Rp1 1/4	25	F0405		
			Rp1 1/2	32	F0405		
			Rp2	40	F0507		

1) Cylindrical barrel with female thread to DIN 2999

Ball valves VAPB, mechanically actuated

Type codes

VAPB – 1 1/2 – F – 63 – F0507 – CR

Type	
VAPB	Ball valve for process automation

Connection to DIN 2999	
1/4	Barrel with female thread Rp1/4
3/8	Barrel with female thread Rp3/8
1/2	Barrel with female thread Rp1/2
3/4	Barrel with female thread Rp3/4
1	Barrel with female thread Rp1
1 1/4	Barrel with female thread Rp1 1/4
1 1/2	Barrel with female thread Rp1 1/2
2	Barrel with female thread Rp2
2 1/2	Barrel with female thread Rp2 1/2
3	Barrel with female thread Rp3
4	Barrel with female thread Rp4

Connection type	
F	Female thread

Max. operating pressure	
25	25 bar
40	40 bar
63	63 bar

Flange hole pattern to ISO 5211	
F03	1 pitch circle diameter of 36 mm
F0304	2 pitch circle diameters of 36 and 42 mm
F0405	2 pitch circle diameters of 42 and 50 mm
F05	1 pitch circle diameter of 50 mm
F0507	2 pitch circle diameters of 50 and 70 mm
F07	1 pitch circle diameter of 70 mm
F0710	2 pitch circle diameters of 70 and 102 mm
F10	1 pitch circle diameter of 102 mm

Material	
	Brass
CR	Special steel casting

Ball valves VAPB, mechanically actuated

Technical data – Brass design

FESTO

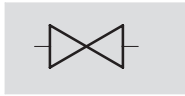

-  - Connecting thread
Rp1/4 ... Rp2 1/2

-  - Flow rate Kv
5.9 ... 535 m³/h

- Connecting thread to DIN 2999
- Mounting flange to ISO 5211
- Blow-out proof shaft assembled from inside
- Centring attachment for simple automation
- O-ring seal for use with a vacuum



General technical data									
Connection	Rp1/4	Rp3/8	Rp1/2	Rp3/4	Rp1	Rp1 1/4	Rp1 1/2	Rp2	Rp2 1/2
Valve function	2/2								
Design	2-way ball valve								
Sealing principle	Soft								
Actuation type	Mechanical								
Switching position display	Slot direction = flow direction								
Direction of flow	Reversible								
Type of mounting	In-line installation								
Assembly position	Any								
Working port 1, 2	1/4	3/8	1/2	3/4	1	1 1/4	1 1/2	2	2 1/2
Internal dia. [mm]	15	15	15	20	25	32	40	50	63
Flow rate Kv [m ³ /h]	5.9	9.4	17	41	70	121	200	292	535
Product weight [g]	500	500	400	500	800	1,300	1,900	3,100	3,100

Operating and environmental conditions									
Connection	Rp1/4	Rp3/8	Rp1/2	Rp3/4	Rp1	Rp1 1/4	Rp1 1/2	Rp2	Rp2 1/2
Operating medium	Compressed air, water, neutral gases, neutral fluids Vacuum								
Nominal pressure, valve [bar]	40	40	40	40	40	40	25	25	25
Temperature of medium [°C]	-20 ... +150								
Corrosion resistance class CRC	1 ¹⁾								
Approved for use in the food industry	No								

1) Corrosion resistance class 1 according to Festo standard 940 070
Components requiring low corrosion resistance. Transport and storage protection. Parts that do not have primarily decorative surface requirements, e.g. in internal areas that are not visible or behind covers.

Materials	
Housing	Brass, nickel-plated
Ball	Brass, hard-chromium plated
Shaft	Brass, nickel-plated
Seals	Housing Polytetrafluoroethylene, fibreglass reinforced
	Shaft Viton

Torque ¹⁾ [Nm]									
Connection, valve	Rp1/4	Rp3/8	Rp1/2	Rp3/4	Rp1	Rp1 1/4	Rp1 1/2	Rp2	Rp2 1/2
Δp = 0 bar	3.1	3.1	3.1	4.6	6.5	10.8	13.5	20	30
Δp = 10 bar	3.5	3.5	3.5	5.1	7.2	11.9	14.9	22	33
Δp = pN	5	5	5	6	8.5	15	19	29	45

1) Torque required for actuating the ball valve

Ball valves VAPB, mechanically actuated

Technical data – Brass design

Permissible operating pressure p as a function of the temperature of the medium t

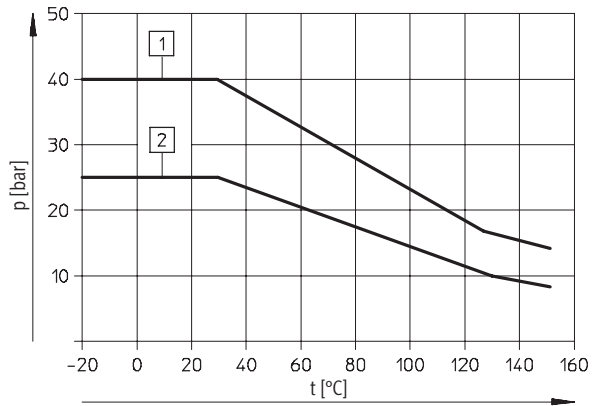

- 1 Rp $\frac{1}{4}$... Rp1 $\frac{1}{4}$
- 2 Rp1 $\frac{1}{2}$... Rp2 $\frac{1}{2}$

Dimensions

Download CAD data → www.festo.com

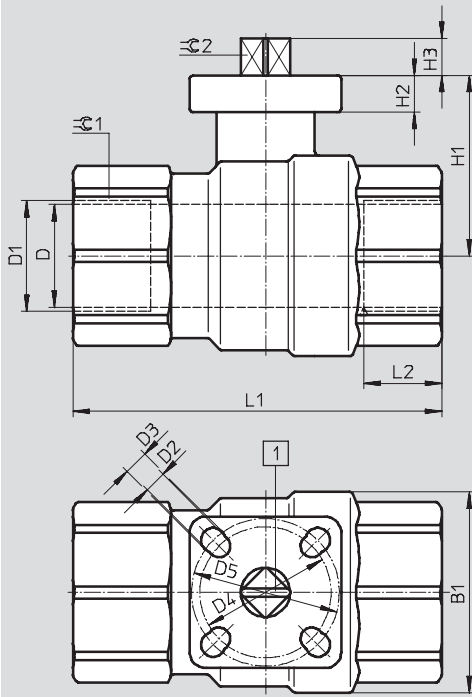

Note
 Switching position display: the slot direction 1 corresponds to the flow direction.

Connection, valve D1 ¹⁾	B1	D ∅ ±0.15	D2 ∅	D3 ∅	D4 ∅	D5 ∅	H1	H2	H3	L1 ±2	L2 max.	≙ 1	≙ 2 -0.1
Rp $\frac{1}{4}$	35	15	5.5	—	36	—	40	9	9	75	15	26	9
Rp $\frac{3}{8}$	35	15	5.5	—	36	—	40	9	9	75	15	26	9
Rp $\frac{1}{2}$	35	15	5.5	—	36	—	40	9	9	75	15	26	9
Rp $\frac{3}{4}$	45	20	5.5	—	36	—	45	9	9	80	16	32	9
Rp1	55	25	5.5	5.5	36	42	45	9	9	90	19	41	9
Rp1 $\frac{1}{4}$	65	32	5.5	6.5	42	50	60	10	11	110	21	50	11
Rp1 $\frac{1}{2}$	75	40	5.5	6.5	42	50	65	10	11	120	21	55	11
Rp2	90	50	6.5	—	50	—	75	12	14	140	25	70	14
Rp2 $\frac{1}{2}$	110	65	8.5	—	70	—	85	10	15.5	143	24	83	14

1) Cylindrical barrel with female thread to DIN 2999

Ball valves VAPB, mechanically actuated

Technical data – Brass design

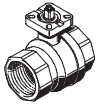
Ordering data			
Version	Connection, valve ¹⁾	Part No.	Type
	Rp $\frac{1}{4}$	534 302	VAPB- $\frac{1}{4}$ -F-40-F03
	Rp $\frac{3}{8}$	534 303	VAPB- $\frac{3}{8}$ -F-40-F03
	Rp $\frac{1}{2}$	534 304	VAPB- $\frac{1}{2}$ -F-40-F03
	Rp $\frac{3}{4}$	534 305	VAPB- $\frac{3}{4}$ -F-40-F03
	Rp1	534 306	VAPB-1-F-40-F0304
	Rp1 $\frac{1}{4}$	534 307	VAPB-1 $\frac{1}{4}$ -F-40-F0405
	Rp1 $\frac{1}{2}$	534 308	VAPB-1 $\frac{1}{2}$ -F-25-F0405
	Rp2	534 309	VAPB-2-F-25-F05
	Rp2 $\frac{1}{2}$	534 310	VAPB-2 $\frac{1}{2}$ -F-25-F07



1) Cylindrical barrel with female thread to DIN 2999

Ball valves VAPB, mechanically actuated

Technical data – Stainless steel design

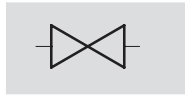
FESTO



-  - Connecting thread
Rp $\frac{1}{4}$... Rp4
-  - Flow rate Kv
16 ... 1,414 m³/h

- Connecting thread to DIN 2999
- Mounting flange to ISO 5211
- Blow-out proof shaft assembled from inside
- Centring attachment for simple automation
- O-ring seal for use with a vacuum



General technical data											
Connection	Rp $\frac{1}{4}$	Rp $\frac{3}{8}$	Rp $\frac{1}{2}$	Rp $\frac{3}{4}$	Rp1	Rp1 $\frac{1}{4}$	Rp1 $\frac{1}{2}$	Rp2	Rp2 $\frac{1}{2}$	Rp3	Rp4
Valve function	2/2										
Design	2-way ball valve										
Sealing principle	Soft										
Actuation type	Pneumatic										
Switching position display	Slot direction = flow direction										
Direction of flow	Reversible										
Type of mounting	In-line installation										
Assembly position	Any										
Internal dia. [mm]	10	12	16	20	25	32	40	50	63	80	100
Flow rate Kv [m ³ /h]	16	21	35	46	72	105	170	275	507	905	1,414
Product weight [g]	200	200	700	800	1,200	1,900	2,800	4,500	9,200	13,900	22,300

Operating and environmental conditions											
Connection	Rp $\frac{1}{4}$	Rp $\frac{3}{8}$	Rp $\frac{1}{2}$	Rp $\frac{3}{4}$	Rp1	Rp1 $\frac{1}{4}$	Rp1 $\frac{1}{2}$	Rp2	Rp2 $\frac{1}{2}$	Rp3	Rp4
Operating medium	Compressed air, water, neutral gases, neutral fluids Vacuum										
Nominal pressure, valve [bar]	63										
Temperature of medium ¹⁾ [°C]	-10 ... +180										
Corrosion resistance class CRC	3 ²⁾										

1) As a function of operating pressure → 8

2) Corrosion resistance class 3 according to Festo standard 940 070

Components requiring higher corrosion resistance. External visible parts in direct contact with industrial atmospheres or media such as solvents and cleaning agents, with a predominantly functional requirement for the surface

Materials		
Housing	High-alloy stainless steel	
Ball	High-alloy stainless steel	
Shaft	High-alloy stainless steel	
Seals	Housing	Polytetrafluoroethylene, fibreglass reinforced
	Shaft	Viton

Torque ¹⁾ [Nm]											
Connection, valve	Rp $\frac{1}{4}$	Rp $\frac{3}{8}$	Rp $\frac{1}{2}$	Rp $\frac{3}{4}$	Rp1	Rp1 $\frac{1}{4}$	Rp1 $\frac{1}{2}$	Rp2	Rp2 $\frac{1}{2}$	Rp3	Rp4
$\Delta p = 0$ bar	5	5	7	9	13	20	28	37	49	54	62
$\Delta p = 10$ bar	5.5	5.5	7.7	9.9	14.3	22	30.8	40.7	53.9	59.4	68.2
$\Delta p = pN$	7	7	10	13	17	28	43	64	69	78	95

1) Torque required for actuating the ball valve

Ball valves VAPB, mechanically actuated

Technical data – Stainless steel design

Permissible operating pressure p as a function of the temperature of the medium t

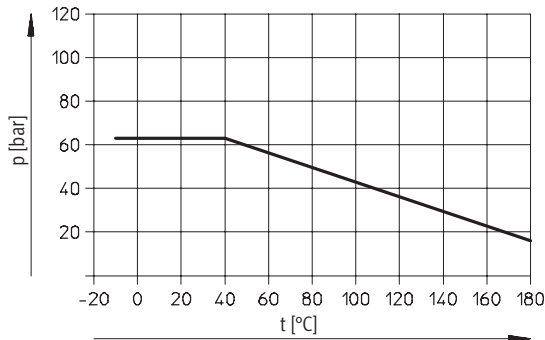

Dimensions

Download CAD data → www.festo.com

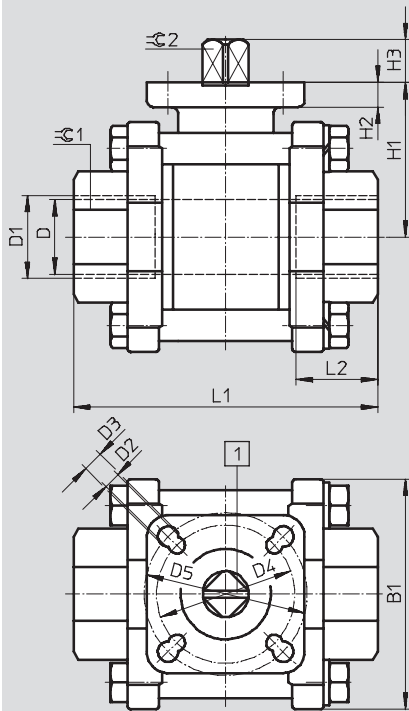

Note

Switching position display: the slot direction 1 corresponds to the flow direction.

Connection, valve D1 ¹⁾	B1	D ∅ ±0.15	D2 ∅	D3 ∅	D4 ∅	D5 ∅	H1	H2	H3	L1 ±2	L2 max.	≙ 1	≙ 2 -0.1
Rp1/4	50	10	5.5	5.5	36	42	40	9	7	65	14	19	9
Rp3/8	50	12	5.5	5.5	36	42	40	9	7	65	14	24	9
Rp1/2	50	16	5.5	5.5	36	42	40	9	7	75	18	29	9
Rp3/4	55	20	5.5	5.5	36	42	44	9	9	80	16	35	9
Rp1	65	25	5.5	6.5	42	50	52	10	12	90	18	41	11
Rp1 1/4	75	32	5.5	6.5	42	50	58	10	12	110	21	50	11
Rp1 1/2	85	40	6.5	9	50	70	68	13	16	120	21	58	14
Rp2	100	50	6.5	9	50	70	77	13	16	140	23	73	14
Rp2 1/2	170	65	9	11	70	102	98	13	19	185	36	90	17
Rp3	200	80	9	11	70	102	110	13	19	205	40	105	17
Rp4	250	100	11	—	102	—	138	20	24	240	40	135	22

1) Cylindrical barrel with female thread to DIN 2999

Ball valves VAPB, mechanically actuated

Technical data – Stainless steel design

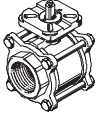
Ordering data			
Version	Connection, valve ¹⁾	Part No.	Type
	Rp1/4	542 843	VAPB-1/4-F-63-F0304-CR
	Rp3/8	542 844	VAPB-3/8-F-63-F0304-CR
	Rp1/2	534 313	VAPB-1/2-F-63-F0304-CR
	Rp3/4	534 314	VAPB-3/4-F-63-F0304-CR
	Rp1	534 315	VAPB-1-F-63-F0405-CR
	Rp1 1/4	534 316	VAPB-1 1/4-F-63-F0405-CR
	Rp1 1/2	534 317	VAPB-1 1/2-F-63-F0507-CR
	Rp2	534 318	VAPB-2-F-63-F0507-CR
	Rp2 1/2	534 319	VAPB-2 1/2-F-63-F0710-CR
	Rp3	534 320	VAPB-3-F-63-F0710-CR
	Rp4	534 321	VAPB-4-F-63-F10-CR

1) Cylindrical barrel with female thread to DIN 2999

Ball valves VZBA, mechanically actuated

Type codes

VZBA – R14 – 63 – 32 L – F0304 – R

Type	
VZBA	Ball valve for process automation

Connection to DIN 2999	
R14	Barrel with female thread Rp1/4
R38	Barrel with female thread Rp3/8
R12	Barrel with female thread Rp1/2
R34	Barrel with female thread Rp3/4
R1	Barrel with female thread Rp1
R114	Barrel with female thread Rp1 1/4
R112	Barrel with female thread Rp1 1/2
R2	Barrel with female thread Rp2

Operating pressure	
63	63 bar

Valve function	
32	3/2-way valve

Hole in ball	
L	L-shaped
T	T-shaped

Flange hole pattern to ISO 5211	
F0304	2 pitch circle diameters of 36 and 42 mm
F0405	2 pitch circle diameters of 42 and 50 mm
F0507	2 pitch circle diameters of 50 and 70 mm

Material	
R	High-alloy stainless steel

Ball valves VZBA, mechanically actuated

Technical data – Stainless steel design

FESTO

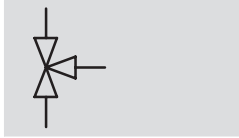

- - Connecting thread
Rp $\frac{1}{4}$... Rp2

- - Flow rate Kv
4.5 ... 1,000 m³/h

- Connecting thread to DIN 2999
- Mounting flange to ISO 5211
- Blow-out proof shaft assembled from inside
- Centring attachment for simple automation
- O-ring seal for use with a vacuum



General technical data		Rp $\frac{1}{4}$	Rp $\frac{3}{8}$	Rp $\frac{1}{2}$	Rp $\frac{3}{4}$	Rp1	Rp1 $\frac{1}{4}$	Rp1 $\frac{1}{2}$	Rp2
Connection, valve									
Valve function		3/2							
Design		3-way ball valve							
Sealing principle		Soft							
Actuation type		Mechanical							
Switching position display		Slot direction = flow direction							
Direction of flow		Reversible							
Type of mounting		In-line installation							
Assembly position		Any							
Working port 1, 2, 3		$\frac{1}{4}$	$\frac{3}{8}$	$\frac{1}{2}$	$\frac{3}{4}$	1	1 $\frac{1}{4}$	1 $\frac{1}{2}$	2
Internal dia.	[mm]	11.6	12.5	12.5	15	20	25	32	40
Flow rate Kv	Type L ¹⁾ [m ³ /h]	4.5	4.5	4.7	5.1	11.8	19.6	33.2	53.7
	Type T ²⁾ [m ³ /h]	8	8	8.3	8.3	22.4	36.5	62	100
	Type T ³⁾ [m ³ /h]	4.5	4.5	4.8	4.8	10.9	18	30	48.8
Product weight	[g]	700	700	700	1,000	1,600	2,800	3,800	7,400

- 1) Ball with L-shaped hole
- 2) Ball with T-shaped hole, straight flow
- 3) Ball with T-shaped hole, flow around corner

Operating and environmental conditions		Rp $\frac{1}{4}$	Rp $\frac{3}{8}$	Rp $\frac{1}{2}$	Rp $\frac{3}{4}$	Rp1	Rp1 $\frac{1}{4}$	Rp1 $\frac{1}{2}$	Rp2
Connection, valve									
Operating medium		Compressed air, water, neutral gases, neutral fluids Vacuum							
Nominal pressure, valve	[bar]	63							
Temperature of medium ¹⁾	[°C]	-10 ... +140							
Corrosion resistance class CRC		3 ²⁾							

- 1) As a function of operating pressure → 12
- 2) Corrosion resistance class 3 according to Festo standard 940 070
Components requiring higher corrosion resistance. External visible parts in direct contact with industrial atmospheres or media such as solvents and cleaning agents, with a predominantly functional requirement for the surface.

Materials	
Housing	High-alloy stainless steel
Ball	High-alloy stainless steel
Shaft	High-alloy stainless steel
Seals	Polytetrafluoroethylene, fibreglass reinforced

Torque ¹⁾ at 63 bar		Rp $\frac{1}{4}$	Rp $\frac{3}{8}$	Rp $\frac{1}{2}$	Rp $\frac{3}{4}$	Rp1	Rp1 $\frac{1}{4}$	Rp1 $\frac{1}{2}$	Rp2
Connection, valve									
$\Delta p = 1$ bar	[Nm]	8	8	8	11	18	26	32	37

- 1) Torque required for actuating the ball valve

Ball valves VZBA, mechanically actuated

Technical data – Stainless steel design



Permissible operating pressure p as a function of the temperature of the medium t

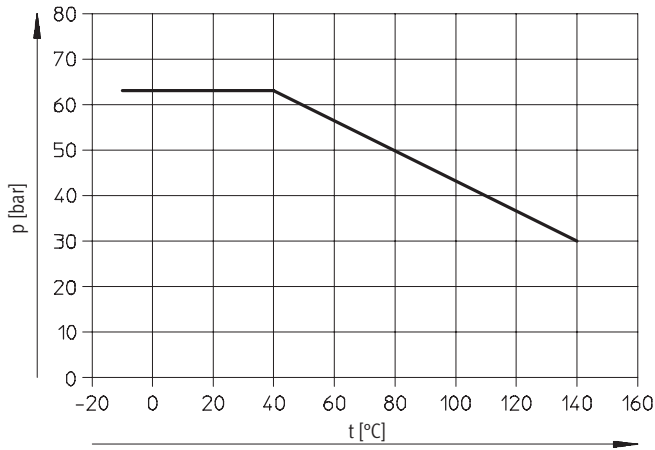

Dimensions

Download CAD data → www.festo.com

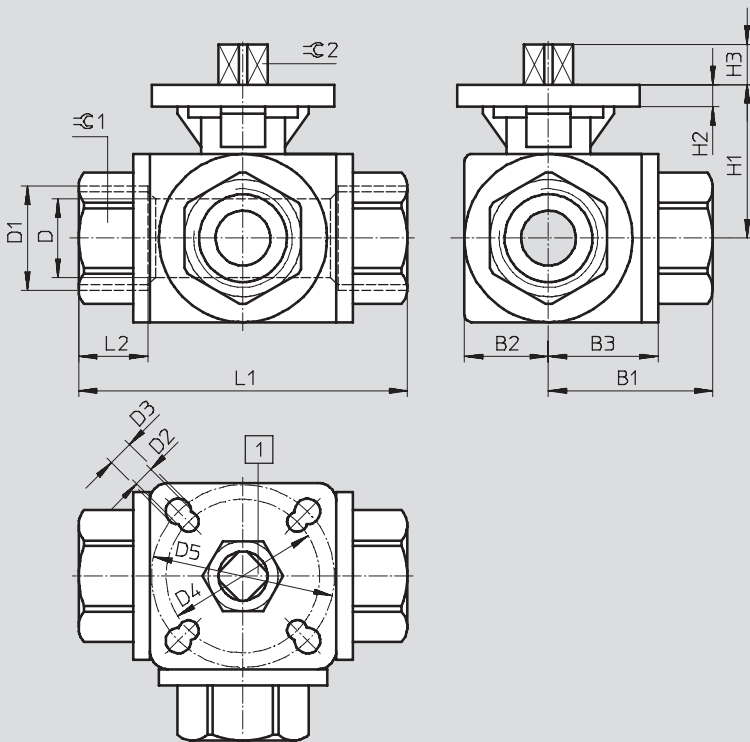

1] Switching position display
T = T-shaped hole

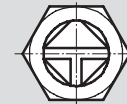

L = L-shaped hole

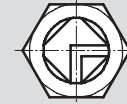

Note

Switching position display: the slot direction corresponds to the flow direction.

Connection, valve D1 ¹⁾	B1	B2	B3	D ∅	D2 ∅	D3 ∅	D4 ∅	D5 ∅	H1	H2	H3	L1	L2	≡C 1	≡C 2
Rp1/4	40	22.4	30	11.6	5.5	5.5	36	42	36	6	7.4	80	16	24	9
Rp3/8	40	22.4	30	12.5	5.5	5.5	36	42	36	6	7.4	80	16	24	9
Rp1/2	40	22	31	12.5	5.5	5.5	36	42	36	6	8.4	80	17.4	27	9
Rp3/4	44	23	34.7	15	5.5	6.5	42	50	42	6.2	12	88	20	34	11
Rp1	51	32	40	20	5.5	6.5	42	50	47	6.3	12	100	20.5	41	11
Rp1 1/4	62	36	47.2	25	5.5	6.5	42	50	53	6.7	11	123	24	50	11
Rp1 1/2	71	43	53	32	5.5	6.5	42	50	59	7	10.8	142	26.6	58	11
Rp2	86	55	63.5	40	6.5	8.5	50	70	66	6.2	15.8	171	27.6	70	14

1) Cylindrical barrel with female thread to DIN 2999

Ball valves VZBA, mechanically actuated

FESTO

Technical data – Stainless steel design

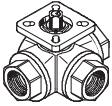
Ordering data					
Version	Connection, valve ¹⁾	L-shaped ball valve		T-shaped ball valve	
		Part No.	Type	Part No.	Type
	Rp1/4	542 005	VZBA-R14-63-32L-F0304-R	542 006	VZBA-R14-63-32T-F0304-R
	Rp3/8	542 007	VZBA-R38-63-32L-F0304-R	542 008	VZBA-R38-63-32T-F0304-R
	Rp1/2	542 009	VZBA-R12-63-32L-F0304-R	542 010	VZBA-R12-63-32T-F0304-R
	Rp3/4	542 011	VZBA-R34-63-32L-F0405-R	542 012	VZBA-R34-63-32T-F0405-R
	Rp1	542 013	VZBA-R1-63-32L-F0405-R	542 014	VZBA-R1-63-32T-F0405-R
	Rp1 1/4	542 015	VZBA-R114-63-32L-F0405-R	542 016	VZBA-R114-63-32T-F0405-R
	Rp1 1/2	542 017	VZBA-R112-63-32L-F0405-R	542 018	VZBA-R112-63-32T-F0405-R
	Rp2	542 019	VZBA-R2-63-32L-F0507-R	542 020	VZBA-R2-63-32T-F0507-R

1) Cylindrical barrel with female thread to DIN 2999

Hand lever for ball valves

Accessory

FESTO

Hand lever VAOH

Note on materials:

- High-alloy stainless steel
- Free of copper and PTFE
- Contains paint wetting impairment substances



Dimensions and ordering data

Download CAD data → www.festo.com

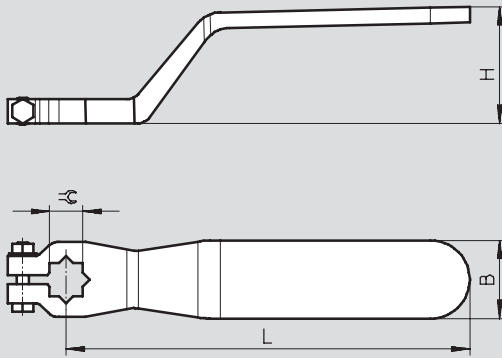

For connection	\varnothing $\pm 0,5$	L ± 10	H ± 5	B ± 5	Weight [g]	Part No.	Type
Rp1/4 ... Rp3/4	9	120	36	21	100	542 702	VAOH-9-H9
Rp1 ... Rp1 1/4	11	140	40	26	200	542 703	VAOH-11-H9
Rp1 1/2 ... Rp2	14	180	46	31	300	542 704	VAOH-14-H9
Rp2 1/2 ... Rp3	17	240	55	36	450	542 705	VAOH-17-H9
Rp4	22	280	70	36	750	542 706	VAOH-22-H9