



- Sturdy, modular valve terminal
- Two valve sizes on one valve terminal
- Flow rates of up to 1,250 l/min
- Vertical stacking at valve level
- Multi-functional electrical peripherals, choice of sturdy metal version Type 03 or modular terminal CPX
- Comprehensive diagnosis, module and channel oriented

# Valve terminal Type 03 VIMP-/VIFB-03, MIDI/MAXI multi-functional

FESTO

Key features



## Innovative

- Multi-functional valve terminal in robust metal housing
  - Flexibly expandable electrical manifold module
- Comprehensive selection of electrical connections:
- Multi-pin
  - All common fieldbuses
  - Integrated controllers for pre-processing
- Suitable for electrical peripherals Type 03 and CPX, consequently:
- Diagnosis right down to each individual valve
  - Parameterisable error characteristics
  - Valves can be supplied with load voltage separate from other outputs
  - On the spot diagnosis with LEDs or CPX handheld terminal (MMI)

## Flexible

- Versatile, configurable, modular system
  - Expandable up to 26 solenoid coils and 12 I/O modules
  - Subsequent conversion and expansion possible
  - Valves and valve functions can easily be switched
  - High pressure range -0.9 ... 10 bar
  - Versatile valve functions
  - Multiple pressure zones can be implemented
- Vertical stacking:
- Pressure regulator
  - Throttle plates

## Reliable

- Sturdy:
- Valve housing made of metal
  - I/O module housing made of metal
  - Electrical connection technology
  - Fast troubleshooting thanks to LED on the valve and diagnosis using fieldbus
  - Convenient servicing thanks to replaceable valves
  - Manual override non-detenting, detenting or protected against activation
  - Flexible labelling system based on inscription labels
- In conjunction with CPX:
- Diagnosis module and channel oriented
  - Comprehensive on the spot diagnosis without a PC, with CPX-MMI only

## Easy to assemble

- Assembled, ready to install and tested unit
- Sturdy mounting and design for harsh environments
- Minimised expenses in the area of selection, ordering, installation and commissioning
- Wall mounting or H-rail mounting

# Valve terminal Type 03 VIMP-/VIFB-03, MIDI/MAXI multi-functional

Key features

## Type 03 valve terminals

Valve terminals comprise the most comprehensive system range in intelligent pneumatics.

The multi-functional Festo valve terminals for MIDI/MAXI valves have a sturdy, modular design. It is possible to have mixed types with different valve sizes. A valve terminal can also have multiple pressure zones and vacuum operation as well as integrated pressure regulators and one-way flow control valves. The valve terminals are

therefore capable of providing versatile and flexible solutions to a wide variety of pneumatic control technology requirements, and the high-quality metal/plastic design and IP65 protection mean that they can be effective even in the harshest operating environments.

A worldwide service and consultation network complete the performance spectrum.

## Multi-pin variants



Valve terminals with multi-pin connections can be normally connected to the I/O cards of all current control systems or industrial PCs. The central control system

requires a powerful PLC with a correspondingly high number of I/O cards and must also be connected to the fieldbus devices with more complex parallel wiring.

Festo offers several installation-saving multiple connection nodes and the appropriate multi-pin connecting cables.

## Connection types

### Multi-pin



Multi-pin connection, round, sturdy design, for up to 24 solenoid coils

### Double multi-pin



Double multi-pin connection, round, up to 6 digital input modules can be attached for sensors

### Sub-D multi-pin connection



Multi-pin connection, Sub-D, protection class IP65, low-cost and slim, for up to 22 solenoid coils

### Control block with electrical I/O modules



Integrated controller and fieldbus interface, I/O modules same as fieldbus connection. Decentralised CP systems can also be connected.

## Fieldbus node with electrical I/O modules



Communication and diagnostics with all common bus systems:

- Up to 12 sturdy Type 03 I/O modules can be assembled
- IP65 connection technology with M12 or Sub-D plugs
- Digital I/O modules
- Analogue I/O modules
- Multi-functional I/O modules
- 2 A outputs for hydraulic valves

## Ordering

-  - Note

Valve terminals are equipped and assembled according to customer requirements. This results in minimal installation time.

Valve terminals are fully inspected before shipment and only need to be mounted with a few screws – ready to go.

A valve terminal Type 03 always consists of two order codes:  
**03P-... (pneumatic components)**  
**03E-... (electrical components)**

For information about the ordering system for Type 03 see the following pages:

Pneumatic components  
 → Internet: typ e03 midi maxi

Electrical peripherals  
 → Internet: type 03

# Valve terminal Type 03 VIMP-/VIFB-03, MIDI/MAXI multi-functional

Key features

FESTO

## User documentation – GSD, EDS, ...

Device description files and icons are used to explain integration of valve terminal Type 03 in the configuration software of the various controller

manufacturers. These can be downloaded quickly and conveniently from → [www.festo.com](http://www.festo.com)



## Valve terminal configurator

Online via: → [www.festo.com](http://www.festo.com)

A valve terminal configurator is available to help you select the right valve terminal to suit your application. This makes it much easier for you to find the right product.

Valve terminals are equipped and assembled according to customer requirements. This results in minimal installation time. They are supplied fully tested.



# Valve terminal Type 03 VIMP-/VIFB-03, MIDI/MAXI multi-functional

Peripherals overview

FESTO

## Electrical part



Control system flexibility thanks to an extensive range of connection nodes:

- Multi-pin connection
- Fieldbus connection
- DeviceNet Direct interface

Stand-alone solutions with integrated PLC (control block) from:

- Festo
- Allen Bradley

Electrical digital inputs/outputs:

- Max. 12 modules in conjunction with suitable nodes (see ordering data)
- Inputs for 24 V DC sensors, PNP or NPN outputs for small-load power consumers 24 V DC
- High-current outputs up to 2 A PNP/NPN, e.g. for hydraulic valves, can be connected directly to the valve terminal

Proportional pneumatics:

- Analogue modules optimised for proportional valves, e.g. for Festo MPYE and MPPES for regulating the force of a cylinder
- To detect, control/regulate universal variables (4 ... 20 mA or 0 ... 10 V) within the process – locally to IP65

Optimising and expanding applications:

- Modules for installation-saving connection using sturdy Sub-D plugs in IP65
- Low-cost connections to input/output stations and control units
- AS-interface master for connection to distributed inputs/outputs covering an extensive range, e.g. in conveyor systems
- Modules for connecting decentralised CPV and CPA valve terminals
- Extensions and supplements can be added at any time

Easy mounting:

- On H-rail
- On mounting surface
- With covers in welding environments

Simple servicing:

- LED display
- Manual override

Ease of maintenance thanks to clip-on inscription labels.

Convenient diagnostics via fieldbus connection and integrated PLC:

- Status bits
- Diagnostic bits
- Integrated self-test

Detailed information on electrical peripherals:

➔ Internet: type 03

# Valve terminal Type 03 VIMP-/VIFB-03, MIDI/MAXI multi-functional

FESTO

Peripherals overview

## Pneumatic components

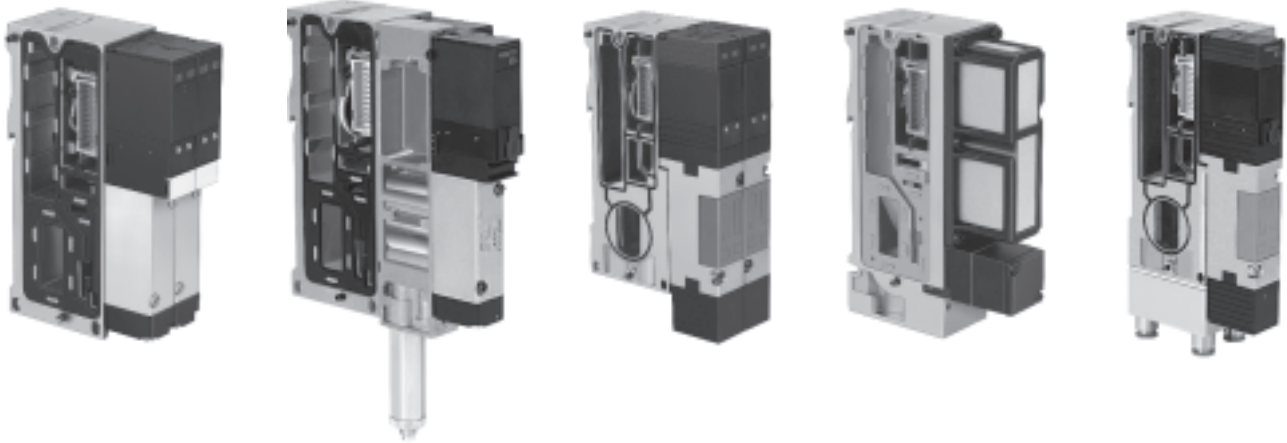

### Midi modules:

- Manifold for two MIDI valves
- 500 l/min
- Max. cylinder diameter 63 mm

### Maxi modules:

- Manifold for two MAXI valves
- 1,250 l/min
- Max. cylinder diameter 80 mm

### Valve actuation:

- All valves have external auxiliary pilot air supply and are therefore suitable for vacuum operation
- If the entire valve terminal is to be operated with a vacuum, the auxiliary pilot air supply must be regulated and supplied externally
- If the auxiliary pilot air supply is generated via one of the regulators of the valve terminal, working pressure of > 4 bar must be applied to this compressed-air supply
- All valves with manual override, non-detenting/detenting/protected against activation (on request)

### Auxiliary modules:

- One-way flow control valves so that the speed of travel can be set separately for single and double-acting cylinders
- One-way flow control valves and pressure regulators can be fitted in working connections
- Intermediate pressure regulator plates for setting the contact pressure of a cylinder via duct 1 or separately via ducts 2 or 4

### Flexible compressed air supply:

- Right-hand end plate with regulator for pilot air and large surface mounted silencer
- Additional compressed air supply with ducted exhaust air or integrated large surface mounted silencer
- Compressed air supply modules without regulator if pilot air is regulated externally
- Multiple pressure zones, including vacuum, are possible for all valve sizes

### Options:

- Spare positions for subsequent extensions
- All connections also supplied with pre-fitted QS fittings (on request)
- All connections can also be supplied with an NPT thread

### Service:

- Multiple valve sizes can be combined on a single terminal
- All valves can be replaced quickly and easily
- All valves are supplied with 1 or 2 LEDs
- All valves are prepared for identification clips
- Flat construction due to large surface mounted silencer
- Online valve terminal configurator available in the electronic catalogue or on the Internet

# Valve terminal Type 03 VIMP-/VIFB-03, MIDI/MAXI multi-functional

Peripherals overview

FESTO

## Multi-functional valve terminal

Components

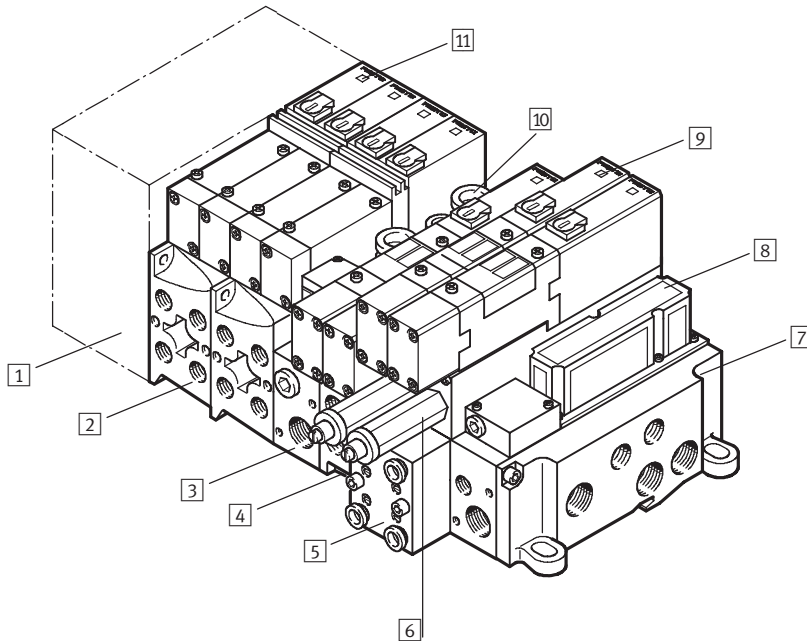

- 1 Multi-pin node/fieldbus node/control block
- 2 Manifold size 4.0 (MIDI)
- 3 Adapter plate sizes from 4.0 to 7.0 with regulator for auxiliary pilot air
- 4 Manifold size 7.0 (MAXI)
- 5 One-way flow control valve
- 6 Pressure regulator
- 7 End plate, right-hand
- 8 Additional compressed air supply with integrated silencer
- 9 Solenoid valve size 7.0, type MTH, JMTH
- 10 Port for ducted exhaust air
- 11 Solenoid valve size 4.0, type MT2H, JMT2H

## Description

Valve terminals Type 03 permit the combination of multiple valve sizes. This assures optimal adaptation to system requirements. The valves have a nominal diameter of 4.0 mm and 7.0 mm.

The transition from nominal diameter 4.0 mm (MIDI) to nominal diameter

7.0 mm (MAXI) is via an adapter plate. The adapter plate can only be used once in any given system. The MIDI valves must be mounted directly next to the nodes, followed by the MAXI valves.

Sequence:

- Node
- MIDI valves

- Adapter plate
- MAXI valves
- End plate

If no MIDI valve is used, the adapter plate must still be installed between the node and the first sub-base for the MAXI valves.

Only valves with separate pilot air supply are used. Pilot pressure is supplied either via the adapter plate or the right-hand end plate. In either case, the maximum permissible pilot pressure is 5 bar. To limit the control pressure, special pressure regulating valves are fitted on the adapter plate or the right-hand end plate.

## Creating pressure zones

### General information

A valve terminal can have multiple pressure zones and vacuum operation as well as integrated pressure regulators and one-way flow control valves.

For more than two pressure zones, multiple “compressed air supplies” or isolating discs can be combined. The isolating disc can only be inserted into a normal manifold and not in the supply block.

### MIDI

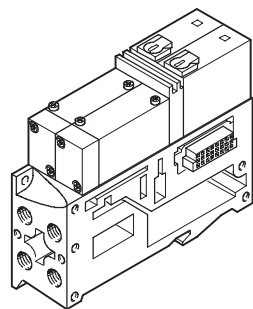

The formation of pressure zones for various pressures, including vacuum, is effected in MIDI valves via a “pressure zone supply”.

The lower pressures should be supplied closest to the node.

### MAXI

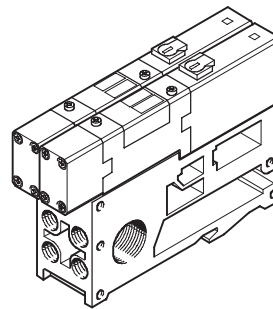

In MAXI valves, pressure zones are formed via the insertion of an isolating disc. Air is then supplied via the adapter plate.

### Additional power supply

 Note  
For valve terminals with more than ten valves and large-volume cylinders, at least one additional compressed air supply should be available.

# Valve terminal Type 03 VIMP-/VIFB-03, MIDI/MAXI multi-functional

Peripherals overview

## Vacuum operation

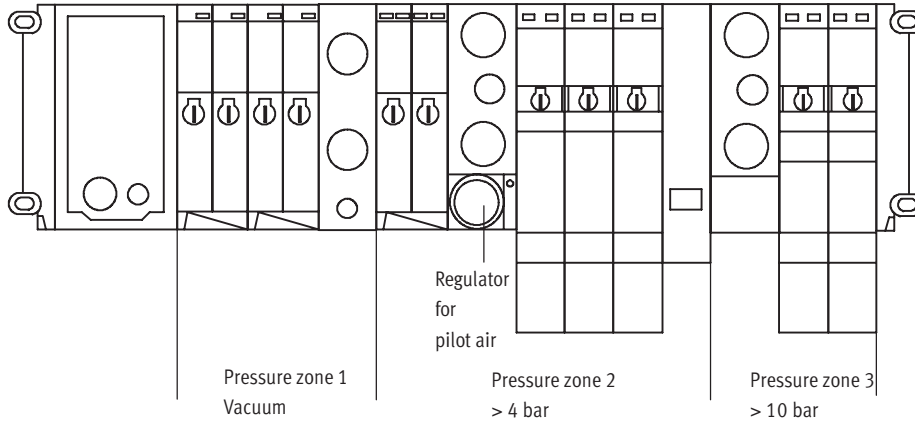

Note

If auxiliary pilot air is generated via one of the regulators of the valve terminal, working pressure of > 4 bar must be applied to this compressed air supply.

If the entire valve terminal is to be operated with a vacuum, the auxiliary pilot air supply must be regulated and supplied externally

For vacuum operation valves require a filter. This is to avoid that foreign matter is drawn into the valve (e.g. when using a suction cup).

## Vertical stacking

### General information

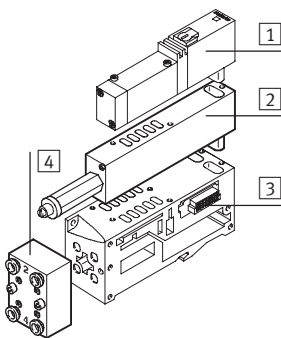

- 1 Solenoid valve
- 2 Pressure regulator
- 3 Manifold sub-base
- 4 One-way flow control block

### Pressure regulator

A pressure regulator can be installed between the sub-base and the valve in order to influence the force of the respective cylinder. There are three variations available:

- Regulation at port 1 (P)
- Regulation at port 2 (B)
- Regulation at port 4 (A)

### One-way flow control valve

A block with one-way flow control valves can be screwed to the front of the sub-base to control the speed of the respective cylinder. A block always contains 4 one-way flow control valves.

### Pressure regulator port 1 (P)

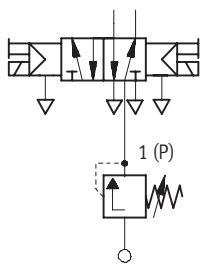

ILR-0,3-ZP-P-4,0  
ILR-0,3-ZP-P-7,0

### Pressure regulator port 2 (B)

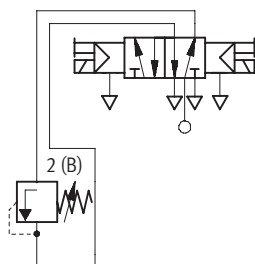

ILR-0,3-ZP-B-4,0  
ILR-0,3-ZP-B-7,0

### Pressure regulator port 4 (A)

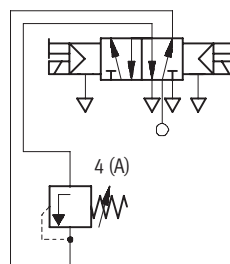

ILR-0,3-ZP-A-4,0  
ILR-0,3-ZP-A-7,0

### One-way flow control valve

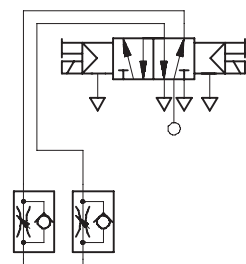

IGR-0,3-AP-A/B-QS-6  
IGR-0,3-AP-A/B-QS-8



# Valve terminal Type 03 VIMP-/VIFB-03, MIDI/MAXI multi-functional

Instructions for use

FESTO

## Equipment

Operate your equipment with unlubricated compressed air if possible. Festo valves and cylinders are designed for operation under normal use without any additional lubrication, yet still have a long service life. The quality of compressed air downstream from the compressor must correspond to that of unlubricated compressed air. If possible, do not operate all of your equipment with lubricated compressed air. The lubricators should, where possible, always be installed directly upstream of the actuators used.

Incorrect additional oil and too high an oil content in the compressed air reduce the service life of a valve terminal.

Use Festo special oil OFSW-32 or the alternatives listed in the Festo catalogue (as specified in DIN 51524 HLP32; basic oil viscosity 32 CST at 40 °C).

## Bio-oils

When using bio-oils (oils which are based upon synthetic or native ester, e.g. rapeseed oil methyl ester), the maximum residual oil content of 0.1 mg/m<sup>3</sup> must not be exceeded (see ISO 8573-1 Class 2).

## Mineral oils

When using mineral oils (e.g. HLP oils to DIN 51524, parts 1 through 3) or similar oils based on poly-alpha-olefins (PAO), the maximum residual oil content of 5 mg/m<sup>3</sup> must not be exceeded (see ISO 8573-1 Class 4)

A higher residual oil content irrespective of the compressor oil cannot be permitted, as the basic lubricant would be washed away over time.



## Welding environment

Valve terminal Type 03 has a high-quality metal/plastic design.

Suitable covers should be used to prevent the terminal being damaged as a result of welding spatter.

# Valve terminal Type 03 VIMP-/VIFB-03, MIDI/MAXI multi-functional

Technical data – Valve terminal Type 03 MIDI

-  - Flow rate  
 Type 03 MIDI:  
 300 ... 500 l/min  
 Type 03 MAXI:  
 1,250 l/min
  
-  - Valve width  
 Type 03 MIDI: 18 mm  
 Type 03 MAXI: 25 mm
  
-  - Voltage  
 24 V DC



General technical data – Type 03 MIDI						
Valve function	5/2-way valve			5/3-way valve		
	With pneumatic spring and pilot air supply	With spring return	Double solenoid valve with pilot air supply	Mid-position closed with pilot air	Mid-position exhausted with pilot air supply	Mid-position pressurised with pilot air supply
Valve function – Code	M, Y	L, Z	J	G	E	B
Constructional design	Piston spool valve					
Width [mm]	18					
Nominal size [mm]	4.0					
Lubrication	Lubrication for life, silicone-free					
Type of mounting	On MIDI/MAXI valve terminal with 2 combi screws					
Mounting position	Any					
Manual override	Detenting					
Nominal flow rate [l/min]	500	500	500	500	300	300

Pressure range [bar]						
Valve function – Code	M, Y	L, Z	J	G	E	B
Operating pressure	-0.9 ... +10					
Operating pressure for valve terminal with internal pilot air supply	4 ... 8					
Pilot pressure	4 ... 6					

Valve response times [ms]							
Valve function – Code	M, Y	L, Z	J	G	E	B	
Response times	On	12	10	-	12	12	12
	Off	22	26	-	25	25	25
	Change-over	-	-	10	-	-	-
Min. switching impulse	-	-	7	-	-	-	

# Valve terminal Type 03 VIMP-/VIFB-03, MIDI/MAXI multi-functional

Technical data – Valve terminal Type 03 MIDI

Ambient conditions	
Operating medium	Filtered compressed air, lubricated or unlubricated → 9
Grade of filtration [μm]	40
Storage temperature [°C]	-20 ... +40
Ambient temperature [°C]	-5 ... +50
Temperature of medium [°C]	-5 ... +50
Corrosion resistance class CRC <sup>1)</sup>	2

- 1) CRC2: Corrosion resistance class to Festo standard 940 070  
 Components requiring moderate corrosion resistance. Externally visible parts with primarily decorative surface requirements which are in direct contact with a surrounding industrial atmosphere or media such as cooling or lubricating agents.

Electrical data	
Protection against electric shock (protection against direct and indirect contact to EN 60204-1/IEC 204)	Through PELV power supply unit
Operating voltage DC	24 V (+10/−15%)
Electrical power consumption per solenoid coil	1.5 W
Protection class to EN 60 529	IP65 (for all types of signal transmission in assembled state)
Vibration resistance	To DIN/IEC 68/EN 60 068, Parts 2-6 <ul style="list-style-type: none"> <li>• Severity level 2 in the case of wall mounting</li> <li>• Severity level 1 in the case of H-rail mounting</li> </ul>
Shock resistance	To DIN/IEC 68/EN 60 068, Parts 2-27 <ul style="list-style-type: none"> <li>• Severity level 2 in the case of wall mounting</li> <li>• Severity level 1 in the case of H-rail mounting</li> </ul>

- 1) The maximum signal line length is 10 m

Materials	
Housing	Die-cast aluminium
Cover	Polyacetate, polyetheretherketone (PEEK), polyamide, steel
Seals	Nitrile rubber

Weights [g]	
End plate without connections	120
Input modules	360
Multi-pin node	580
Blanking plate	60
Bus node	Approx. 1000
Output modules	400
Manifold block	300
Valve	140 ... 160
Pressure regulator	100
One-way flow control valve	120

# Valve terminal Type 03 VIMP-/VIFB-03, MIDI/MAXI multi-functional

FESTO

Technical data – Valve terminal Type 03 MAXI

General technical data – Type 03 MAXI					
Valve function	5/2-way valve			5/3-way valve	
	With pneumatic spring and pilot air supply	Double solenoid valve with pilot air supply	Mid-position closed with pilot air supply	Mid-position exhausted with pilot air supply	Mid-position pressurised with pilot air supply
Valve function – Code	M, Y	J	G	E	B
Constructional design	Piston spool valve				
Width [mm]	25				
Nominal size [mm]	7				
Lubrication	Lubrication for life, silicone-free				
Type of mounting	On MIDI/MAXI valve terminal with 2 combi screws				
Mounting position	Any				
Manual override	Detenting				
Nominal flow rate [l/min]	1300				

Pressure range [bar]					
Valve function – Code	M, Y	J	G	E	B
Operating pressure	-0.9 ... +10				
Operating pressure for valve terminal with internal pilot air supply	4 ... 8				
Pilot pressure	4 ... 6				

Valve response times [ms]						
Valve function – Code	M, Y	J	G	E	B	
Response times	On	25	-	25	25	25
	Off	30	-	55	55	55
	Change-over	-	18	-	-	-
Min. switching impulse	10	10	10	10	10	

Ambient conditions	
Operating medium	Filtered compressed air, lubricated or unlubricated → 9
Grade of filtration [µm]	50
Storage temperature [°C]	-20 ... +40
Ambient temperature [°C]	-5 ... +50
Temperature of medium [°C]	-5 ... +50
Corrosion resistance classification CRC <sup>1)</sup>	2

1) CRC2: Corrosion resistance class to Festo standard 940 070  
Components requiring moderate corrosion resistance. Externally visible parts with primarily decorative surface requirements which are in direct contact with a surrounding industrial atmosphere or media such as cooling or lubricating agents.

# Valve terminal Type 03 VIMP-/VIFB-03, MIDI/MAXI multi-functional

Technical data – Valve terminal Type 03 MAXI

Electrical data	
Protection against electric shock (protection against direct and indirect contact to EN 60204-1/IEC 204)	Through PELV power supply unit
Operating voltage DC	24 V (+10/-15%)
Electrical power consumption per solenoid coil	2.2 W
Protection class to EN 60 529	IP65 (for all types of signal transmission in assembled state)
Vibration resistance	To DIN/IEC 68/EN 60 068, Parts 2-6 <ul style="list-style-type: none"> <li>• Severity level 2 in the case of wall mounting</li> <li>• Severity level 1 in the case of H-rail mounting</li> </ul>
Shock resistance	To DIN/IEC 68/EN 60 068, Parts 2-27 <ul style="list-style-type: none"> <li>• Severity level 2 in the case of wall mounting</li> <li>• Severity level 1 in the case of H-rail mounting</li> </ul>

1) The maximum signal line length is 10 m

Materials	
Housing	Die-cast aluminium
Cover	Polyacetate, polyetheretherketone (PEEK), polyamide, steel
Seals	Nitrile rubber

Weights [g]	
End plate without connections	435
Input modules	360
Multi-pin node	580
Blanking plate	63
Bus node	Approx. 1000
Output modules	400
Manifold block	552
Valve	Approx. 313
Pressure regulator	188
One-way flow control valve	237

## Connections

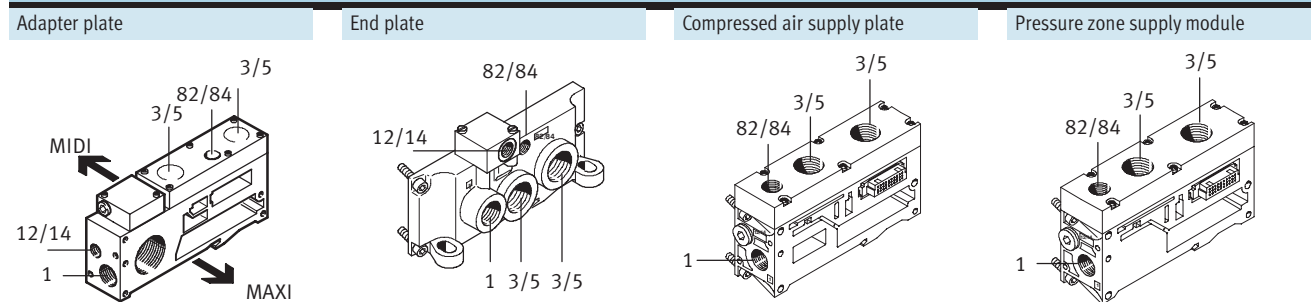

Connection	1	3/5	12/14	82/84	Valves
MIDI	G $\frac{3}{8}$	G $\frac{1}{2}$	G $\frac{1}{8}$	G $\frac{1}{8}$	G $\frac{1}{8}$
MAXI	G $\frac{1}{2}$	G $\frac{1}{2}$	G $\frac{1}{4}$	G $\frac{1}{4}$	G $\frac{1}{4}$

# Valve terminal Type 03 VIMP-/VIFB-03, MIDI/MAXI multi-functional

Technical data – Valve terminal Type 03 multi-pin

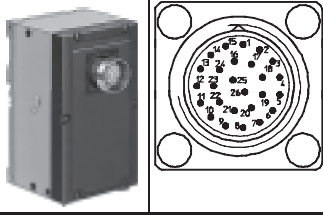
Pin allocation for multi-pin node with round plug MP 1							
View	Pin - Plug	Core - Cable 14 cores	Core - Cable 26 cores	Solenoid coil <sup>1)</sup>			
				Type PNP		Type NPN	
				Coil	Voltage	Coil	Voltage
	1 ... 12	1 ... 12	1 ... 12	0 ... 11	24 V	0 ... 11	0 V
	13 ... 24	-	13 ... 24	12 ... 23	24 V	12 ... 23	0 V
	25 ... 26	13 ... 14	25 ... 26	-	0 V (supply voltage)	-	24 V (supply voltage)

1) Counting of solenoid coils: Starting from the multi-pin node from left to right and from top to bottom continuously.

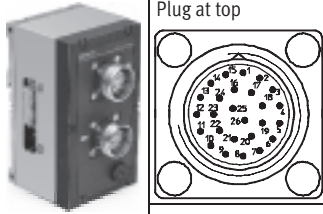
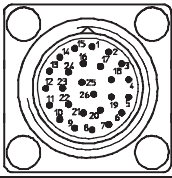
Pin allocation for multi-pin node with round plugs MP 2							
View	Pin - Plug	Core - Cable 26 cores	Type PNP		Type NPN		
			Coil	Supply voltage	Coil	Supply voltage	
	Plug at top	1 ... 12	1 ... 24	Solenoid coil <sup>1)</sup> 0 ... 23	-	Solenoid coil <sup>1)</sup> 0 ... 23	
		25 ... 26	25 ... 26	-	0 V	-	24 V
	Plug at bottom	1 ... 8	1 ... 8	Input <sup>2)</sup> 0 ... 7	-	Input <sup>2)</sup> 0 ... 7	
		9	9	-	0 V	-	24 V
		10	10	-	24 V	-	0 V
		25 ... 26	25 ... 26	Input <sup>2)</sup> 8 ... 23	-	Input <sup>2)</sup> 8 ... 23	-

1) Counting of solenoid coils: Starting from the multi-pin node from left to right and from top to bottom continuously.

2) Counting of inputs: Starting from the multi-pin node from left to right and from top to bottom continuously.  
The input module, 8 fold, has 2 inputs on a terminal socket.

# Valve terminal Type 03 VIMP-/VIFB-03, MIDI/MAXI multi-functional

Technical data – Valve terminal Type 03 multi-pin

Pin allocation for multi-pin node with Sub-D plug MP4					
View	Pin - Plug	R/3 - Pin	Signal		
			positive switching	negative switching	
 <div style="border: 1px solid black; padding: 5px; display: inline-block; margin-top: 10px;"> <p>14+ + 1 15+ + 2 16+ + 3 17+ + 4 18+ + 5 19+ + 6 20+ + 7 21+ + 8 22+ + 9 23+ +10 24+ +11 25+ +12 +13</p> </div>	1	A1	VSP0	VSP0	
	2	A2	VSP1	VSP1	
	3	B1	VSP2	VSP2	
	4	B2	VSP3	VSP3	
	5	C1	VSP4	VSP4	
	6	C2	VSP5	VSP5	
	7	A3	VSP6	VSP6	
	8	A4	VSP7	VSP7	
	9	B3	VSP8	VSP8	
	10	B4	VSP9	VSP9	
	11	C3	VSP10	VSP10	
	12	C4	VSP11	VSP11	
	13	A5	VSP12	VSP12	
	14	A6	VSP13	VSP13	
	15	B5	VSP14	VSP14	
	16	B6	VSP15	VSP15	
	17	C5	VSP16	VSP16	
	18	C6	VSP17	VSP17	
	19	A7	VSP18	VSP18	
	20	A8	VSP19	VSP19	
	21	B7	VSP20	VSP20	
	22	B8	VSP21	VSP21	
	23	C7	-	-	
	24	C10	0 V	24 V	
	25	B10	0 V	24 V	
Housing	A10	-	Earthing		
Housing	A9	-	Earthing		





# Valve terminal Type 03 VIMP-/VIFB-03, MIDI/MAXI multi-functional

Technical data – Valve terminal Type 03 MIDI/MAXI

## Dimensions

Download CAD data → [www.festo.com](http://www.festo.com)

Valve terminal Type 03 with multi-pin connection MP4

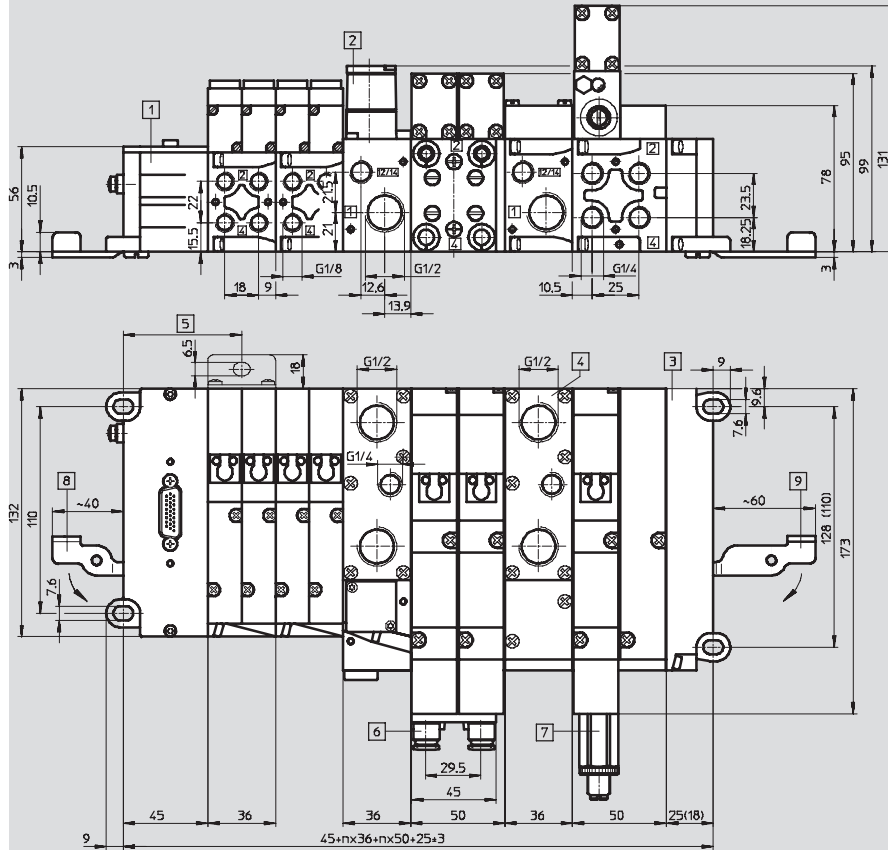

- |  |  |   |   |
|--|--|---|---|
| 1 Multi-pin node with SUB-D plug   | 4 Compressed air supply plate                                      | 7 Pressure regulator  | 9 Swivel lever IBGH-03-7,0<br>(opened out) for connection to<br>mounting rail |
| 2 Adapter plate MIDI + MAXI with<br>pressure regulator for pilot<br>pressure | 5 Mounting bracket<br>(for wall mounting required every<br>200 mm) | 8 Swivel lever IBGH-03-4,0<br>(opened out) for connection to<br>mounting rail |   |
| 3 End plate, right-hand  | 6 One-way flow control block                                       |   |   |

# Valve terminal Type 03 VIMP-/VIFB-03, MIDI/MAXI multi-functional

Technical data – Valve terminal Type 03 MIDI/MAXI

## Dimensions

Download CAD data → [www.festo.com](http://www.festo.com)

Valve terminal Type 03 with multi-pin connection MP2

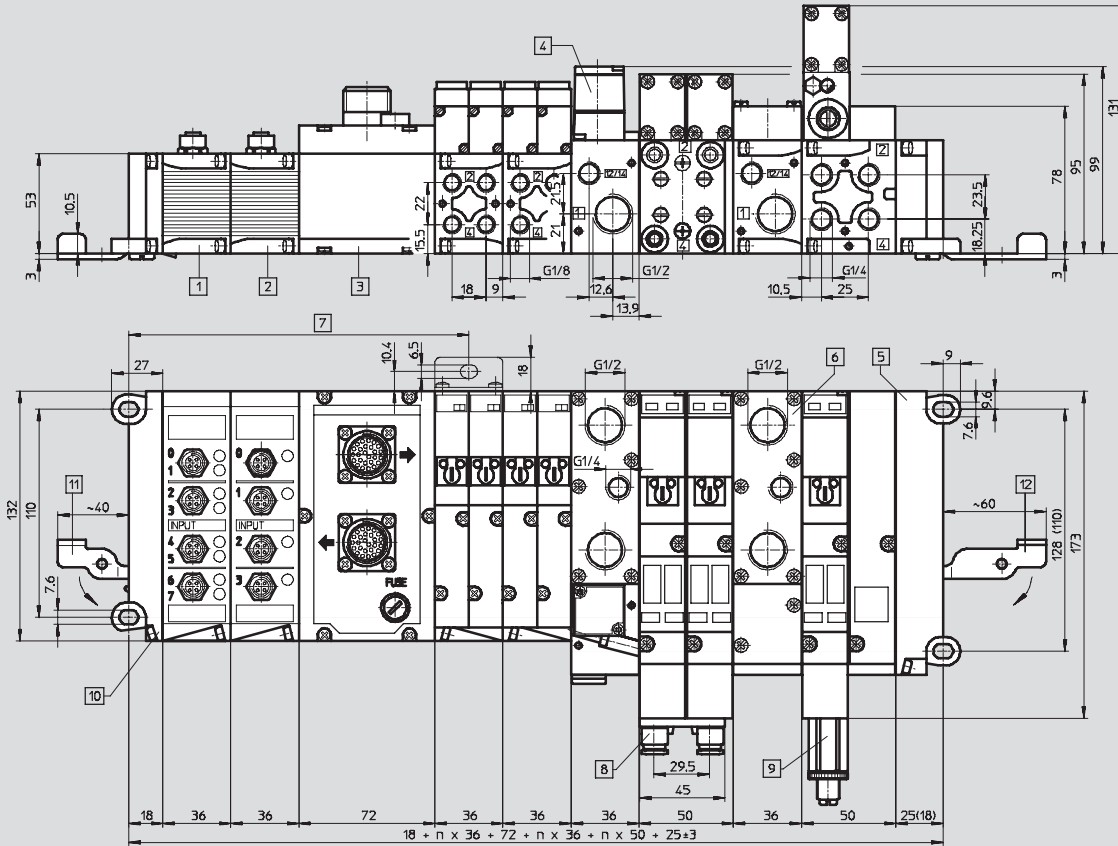

- |  |  |  |  |
|--|--|--|--|
| 1 8-fold input module  | 5 End plate, right-hand  | 9 Pressure regulator   | 12 Swivel lever IBGH-03-7,0<br>(opened out) for connection to<br>mounting rail |
| 2 4-fold input module  | 6 Compressed air supply plate                                      | 10 End plate, left-hand  |  |
| 3 Multi-pin node MP2 with round<br>plugs                                   | 7 Mounting bracket<br>(for wall mounting required every<br>200 mm) | 11 Swivel lever IBGH-03-4,0<br>(opened out) for connection to<br>mounting rail |  |
| 4 Adapter plate MIDI/MAXI with<br>pressure regulator for pilot<br>pressure | 8 One-way flow control block                                       |  |  |

# Valve terminal Type 03 VIMP-/VIFB-03, MIDI/MAXI multi-functional

Technical data – Valve terminal Type 03 MIDI/MAXI end plate

End plate, MIDI valves

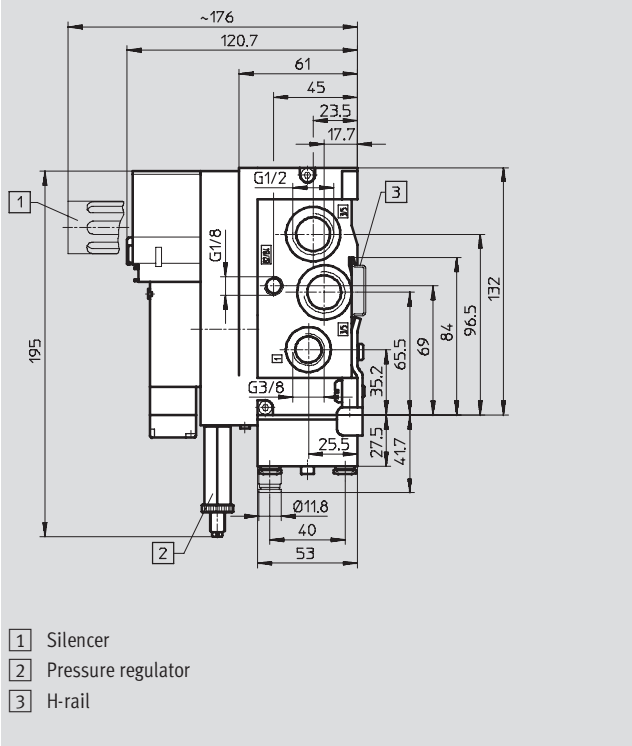

End plate, MAXI valves

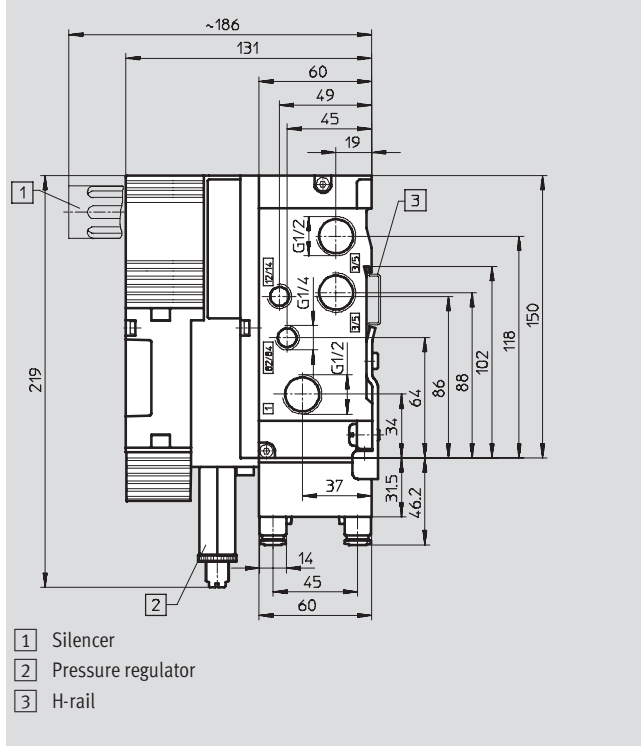

# Valve terminal Type 03 VIMP-/VIFB-03, MIDI/MAXI multi-functional

Technical data – Adjustable four-fold one-way flow control block for MIDI/MAXI valves

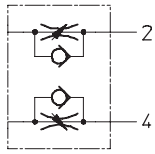

- Compact valve module
  - Direct attachment to the manifold
- These valves are used to regulate air flow, e.g. to control the piston speeds of single or double-acting cylinders. Non-return valves block air flow in one direction. Air is only able to flow via the cross section which is adjusted with the throttle screw. Air flows freely in the other direction through the open non-return valve.



General technical data			
Type		IGR-03-A-P-A/B-QS-6 (MIDI)	IGR-03-A-P-A/B-QS-8 (MAXI)
Part No.		164 947	164 948
Constructional design	Flow control valve	Annular gap	
	Non-return valve	Pressure relief gasket	
Width	[mm]	36	50
Nominal size	[mm]	4.0	7.0
Type of mounting		On MIDI/MAXI valve terminal with 2 combi screws	
Mounting position		Any	
Ambient temperature	[°C]	-10 ... +60	
Temperature of medium	[°C]	-10 ... +60	
Operating medium		Filtered compressed air, lubricated or unlubricated → 9	
Operating pressure	[bar]	0.3 ... +10	
Nominal flow rate in flow control direction, flow control valve open <sup>1)</sup>	[l/min]	270	570
Nominal flow rate in non-return direction, flow control valve open <sup>1)</sup>	[l/min]	270	550
Nominal flow rate in non-return direction, flow control valve closed	[l/min]	200	350
Weight	[g]	120	237

1) 10 turns

Materials	
Housing	Aluminium
Regulating screws	Brass
Seals	Nitrile rubber

# Valve terminal Type 03 VIMP-/VIFB-03, MIDI/MAXI multi-functional

Technical data – Adjustable four-fold one-way flow control block for MIDI/MAXI valves

## Control characteristic

Type IGR-03-...

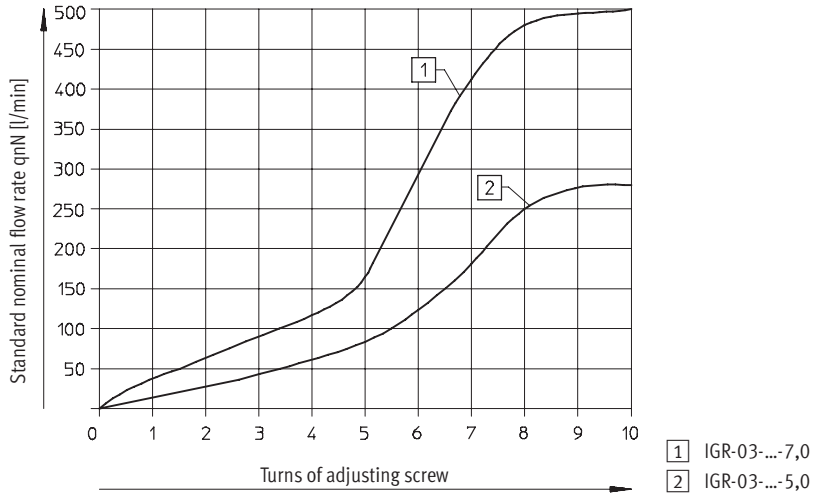

# Valve terminal Type 03 VIMP-/VIFB-03, MIDI/MAXI multi-functional

Technical data – Pressure regulator for MIDI/MAXI valves

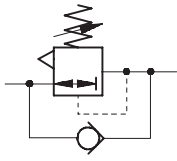

An adjustable pressure regulator can be installed between the sub-base and the valve in order to control the force of the respective cylinder. This pressure regulating valve maintains an essentially constant output pressure (secondary side) independent of pressure fluctuations (primary side) and air consumption.



General technical data (MIDI)			
Type	ILR-03-ZP-P-4,0	ILR-03-ZP-A-4,0	ILR-03-ZP-B-4,0
Part No.	164 941	164 943	164 945
Constructional design	Piston regulator		
Width [mm]	18		
Nominal size [mm]	4.0		
Type of mounting	On MIDI/MAXI valve terminal with 2 combi screws		
Mounting position	Any		
Ambient temperature [°C]	-10 ... +60		
Temperature of medium [°C]	-10 ... +60		
Operating medium	Filtered compressed air, lubricated or unlubricated → 9		
Input pressure [bar]	0 ... +10		
Output pressure [bar]	0 ... +8		
Weight [g]	100		

General technical data (MAXI)			
Type	ILR-03-ZP-P-7,0	ILR-03-ZP-A-7,0	ILR-03-ZP-B-7,0
Part No.	164 942	164 944	164 946
Constructional design	Piston regulator		
Width [mm]	25		
Nominal size [mm]	7.0		
Type of mounting	On MIDI/MAXI valve terminal with 2 combi screws		
Mounting position	Any		
Ambient temperature [°C]	-10 ... +60		
Temperature of medium [°C]	-10 ... +60		
Operating medium	Filtered compressed air, lubricated or unlubricated → 9		
Input pressure [bar]	0 ... +10		
Output pressure [bar]	0 ... +8		
Weight [g]	188		

Materials	
Housing	Aluminium
Seals	Nitrile rubber

# Valve terminal Type 03 VIMP-/VIFB-03, MIDI/MAXI multi-functional

Technical data – Pressure regulator for MIDI/MAXI valves

## Components

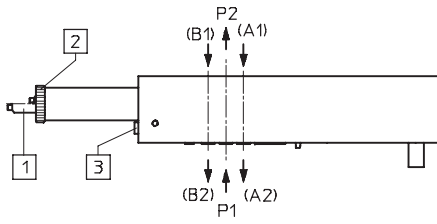

- 1 Pressure adjustment screw for 0 ... 8 bar range
- 2 Lock nut
- 3 Pressure indicator connection:
  - M3 (MIDI)
  - M5 (MAXI)

## Characteristic flow rate curve

MIDI

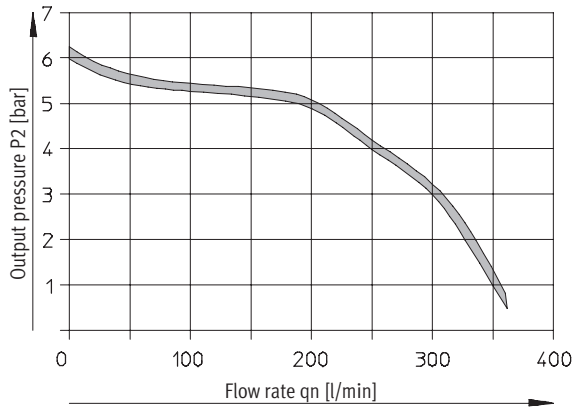

MAXI

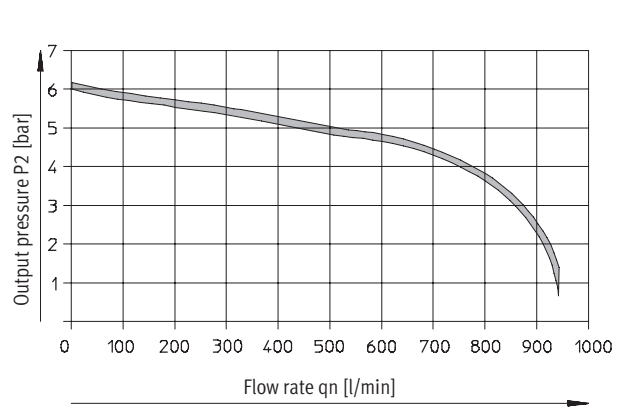

# Valve terminal Type 03 VIMP-/VIFB-03, MIDI/MAXI multi-functional

Technical data – Input module for multi-pin node

- Max. 24 inputs
- Input module for 24 V DC sensor signals
- M12 plug, single allocation connection technology in 4-fold modules, double allocation connection technology in 8-fold modules
- M12 plug, 4-pin
- The input statuses are indicated for each input signal on an assigned LED
- 24 V DC voltage supplied for all connected sensors
- Module width: 36 mm



**Note**  
The input module for multi-pin node MP4/8 can only be used with the multi-pin variant of valve terminal Type 03. It is not suitable for use with Type VIFB-03.

Application			
Applications	Overall power requirement	Sensor operation	
Input modules provide for the connection of cylinder sensors or other 24 V DC sensors (inductive, capacitive, etc.). Plugs with double allocation are separated using a DUO plug or DUO cable.	The overall power requirement for all connected sensors on a valve terminal may not exceed 2 A.	If negative switching sensors are used, 24 V DC and 0 V DC must be swapped on the multi-pin node, i.e. 24 V DC must be applied to pin 3 on the sensor socket, and 0 V DC must be applied to pin 1.	Pin allocations must therefore be checked before the sensors are connected. Positive switching sensors and negative switching sensors cannot be used together.

General technical data (MIDI)			
Type	VIGE-03-MP-4		VIGE-03-MP-8
Part No.	18 672		18 657
No. of inputs	4		8
No. of occupied module positions	1		
Sensor connection type	4 x M12, 4-pin, socket with single allocation		Socket with double allocation
Max. power supply per channel [A]	2		
Max. sensor supply per module [A]	2		
Fuse protection for sensor supply	Central fuse 2 A, on system supply		
Supply voltage of sensors [V DC]	24 ± 10%, coming from multi-pin node		
Ambient temperature [°C]	-5 ... +50		
Storage temperature [°C]	-20 ... +60		
Material	Aluminium die-cast		
Protection class to EN 60 529	IP65		
Dimensions [mm]	42 x 70 x 132		
Weight [g]	360		



# Valve terminal Type 03 VIMP-/VIFB-03, MIDI/MAXI multi-functional

Technical data – Input module for multi-pin node

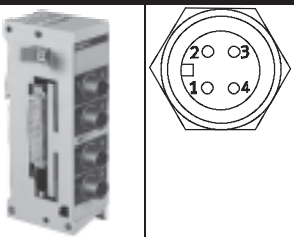
Pin allocation of inputs in multi-pin nodes							
View	Plug (from top to bottom)	Pin	MP4		MP8		
			Allocation	LED	Allocation	LED	
	1	1	24 V	0	24 V	0	
		2	Free		lx +1		
		3	0 V		0 V		1
		4	lx		lx		
	2	1	24 V	1	24 V	2	
		2	Free		lx +1		
		3	0 V		0 V		3
		4	lx +1		lx +2		
	3	1	24 V	2	24 V	4	
		2	Free		lx +1		
		3	0 V		0 V		5
		4	lx +2		lx +4		
	4	1	24 V	3	24 V	6	
		2	Free		lx +1		
		3	0 V		0 V		7
		4	lx +3		lx +4		

# Valve terminal Type 03 VIMP-/VIFB-03, MIDI/MAXI multi-functional

FESTO

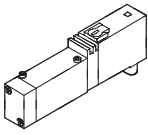
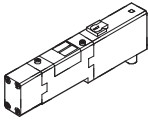
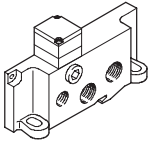
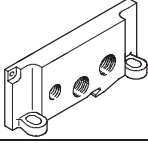
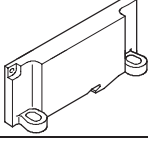
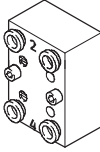
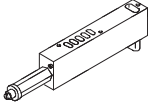

Ordering data – Accessories

Ordering data				
	Code	Description	Type	Part No.
<b>Solenoid valves MIDI</b>				
	M/Y	5/2-way valve, single solenoid, pneumatic spring return	MT2H-5/2-5,0-L-S-VI-B	159 452
	L/Z	5/2-way valve, single solenoid, mechanical spring return	MT2H-5/2-5,0-S-VI-B	159 454
	J	5/2-way valve, double solenoid	JMT2H-5/2-5,0-S-VI-B	159 453
	B	5/3-way valve, mid-position pressurised	MT2H-5/3B-5,0-S-VI-B	159 450
	E	5/3-way valve, mid-position exhausted	MT2H-5/3E-5,0-S-VI-B	159 449
	G	5/3-way valve, mid-position closed	MT2H-5/3G-5,0-S-VI-B	159 448
<b>Solenoid valves MAXI</b>				
	M/Y	5/2-way valve, single solenoid, pneumatic spring return	MTH-5/2-7,0-L-S-VI	151 700
	J	5/2-way valve, double solenoid	JMTH-5/2-7,0-S-VI	151 701
	B	5/3-way valve, mid-position pressurised	MTH-5/3B-7,0-S-VI	151 704
	E	5/3-way valve, mid-position exhausted	MTH-5/3E-7,0-S-VI	151 703
	G	5/3-way valve, mid-position closed	MTH-5/3G-7,0-S-VI	151 702
<b>Right-hand end plate</b>				
	R	With regulator MIDI	IEPR-03-4,0-LR	18 781
	H	Without regulator MIDI	IEPR-03-4,0-P	18 645
	H	Without regulator MAXI	IEPR-03-7,0-P	18 744
	E	Without connections MIDI	IEPR-03-4,0	175 205
	E	Without connections MAXI	IEPR-03-7,0	18 749
	<b>One-way flow control block</b>			
	Q	One-way flow control block MIDI	IGR-03-AP-A/B-QS-6	164 947
	Q	One-way flow control block MAXI	IGR-03-AP-A/B-QS-8	164 948
<b>Pressure regulator</b>				
	P	Port P MIDI	ILR-03-ZP-P-4,0	164 941
	P	Port P MAXI	ILR-03-ZP-P-7,0	164 942
	R	Port A MIDI	ILR-03-ZP-A-4,0	164 943
	R	Port A MAXI	ILR-03-ZP-A-7,0	164 944
	D	Port B MIDI	ILR-03-ZP-B-4,0	164 945
	D	Port B MAXI	ILR-03-ZP-B-7,0	164 946

# Valve terminal Type 03 VIMP-/VIFB-03, MIDI/MAXI multi-functional

FESTO

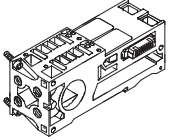
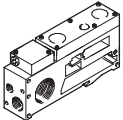
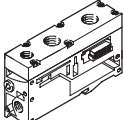
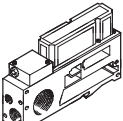
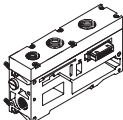
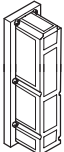
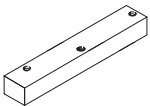
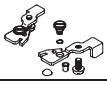
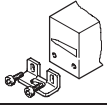



Ordering data – Accessories

Ordering data				
	Code	Description	Type	Part No.
<b>Manifold sub-base</b>				
		Single solenoid, MIDI	VIGM-03-4,0	18 652
		Single solenoid, MAXI	VIGM-03-7,0	18 742
		Double solenoid, MIDI	VIGI-03-4,0	18 653
		Double solenoid, MAXI	VIGI-03-7,0	18 743
<b>Adapter plate</b>				
	XX	Midi / Maxi	VIGP-03-7,0-4,0-LR	18 748
	WW	Without regulator	VIGP-03-7,0-4,0	18 740
	DD	Compressed air supply, MIDI	VIGP-03-4,0	18 654
	DD	Compressed air supply, MAXI	VIGP-03-7,0	18 741
	HH	Compressed air supply with silencer MIDI	VIGP-03-4,0-U	525 433
	HH	Compressed air supply with silencer MAXI	VIGP-03-7,0-U	525 435
	NN	MIDI/MAXI with silencer	VIGP-03-7,0-4,0-U	525 436
	FF	MIDI/MAXI with regulator and silencer	VIGP-03-7,0-4,0-LR-U	525 437
	UU	Additional pressure zone MIDI	VIGZ-03-4,0	18 638
	VV	Additional pressure zone MIDI with silencer	VIGZ-03-4,0-U	525 434
<b>Surface mounted silencer</b>				
		Large surface mounted silencer MIDI	IU-03-4,0	165 635
		Large surface mounted silencer MAXI	IU-03-7,0	165 636
<b>Cover</b>				
	C	Blanking plate MIDI	IAP-03-4,0	18 648
	A	Blanking plate MAXI	IAP-03-7,0	18 745
<b>Mounting</b>				
	B	For H-rail MIDI	IBGH-03-4,0	18 649
	B	For H-rail MAXI	IBGH-03-7,0	18 747
	W	Mounting bracket	IBGW-03	18 678
<b>Small parts</b>				
	S	Isolating disc, MAXI	NSC-1/2-03-7,0	18 746
		Inscription labels, 9x20 in frames (20 pieces)	IBS-9x20	18 182
		Inscription labels, 10x17 in frames (30 pieces)	IBS-10x17	160 238

# Valve terminal Type 03 VIMP-/VIFB-03, MIDI/MAXI multi-functional

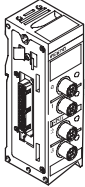
FESTO

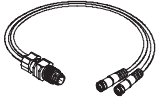
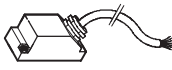
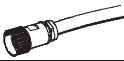
Ordering data – Accessories

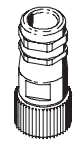
Ordering data				
	Code	Description	Type	Part No.
<b>Modules</b>				
	F	Input module for multi-pin, 4-fold	VIGE-03-MP-4	18 672
	E	Input module for multi-pin, 8-fold	VIGE-03-MP-8	18 657
<b>Plug</b>				
	S	Plug, straight socket, M12, 4-pin, PG7	SEA-GS-7	18 666
	W	4-pin, 2.5 mm <sup>2</sup> O.D.	SEA-4GS-7-2,5	192 008
	X	Plug for 2 sensor cables, M12, PG11, 4-pin	SEA-GS-11-DUO	18 779
<b>Cables</b>				
		DUO cable, 2x straight sockets	KM12-DUO-M8-GDGD	18 685
		DUO cable, straight/angled socket	KM12-DUO-M8-GDWD	18 688
		DUO cable, 2x angled sockets	KM12-DUO-M8-WDWD	18 687
<b>Multi-pin plug connection</b>				
	H	Connecting cable for multi-pin node MP4, with Sub-D connection, 5 m	KEA-1-25P-5	177 413
	J	Connecting cable for multi-pin node MP4, with Sub-D connection, 10 m	KEA-1-25P-10	177 414
		Connecting cable for multi-pin node MP4, with Sub-D connection, X length	KEA-1-25P-X	177 415
		Connecting cable, 26-pin, for inputs, 10 m	KMP2-03-E-10-26	175665
		Connecting cable, 26-pin, for valves, 10 m	KMP2-03-V-10-26	175667
	E	Socket for multi-pin node MP2, 25-pin	SD-SUB-D-BU25	18 709
	Y	Multi-pin plug socket for multi-pin node MP2, for valves	IMP2-SD-26-V	18 664
	Q	Multi-pin plug socket for multi-pin node MP2, for inputs/outputs	IMP2-SD-26-EA	18 665

# Valve terminal Type 03 VIMP-/VIFB-03, MIDI/MAXI multi-functional

**FESTO**

Ordering data – Accessories

Ordering data					
	Description	Allocation	Language	Type	Part No.
User documentation					
	User documentation valve terminals Type 03	Type 03 Pneumatics MIDI/MAXI	German	PBE-MIDI/MAXI-03-DE	152 770
			English	PBE-MIDI/MAXI-03-EN	152 771
			Spanish	PBE-MIDI/MAXI-03-ES	163 917
			French	PBE-MIDI/MAXI-03-FR	163 937
			Italian	PBE-MIDI/MAXI-03-IT	165 441
			Swedish	PBE-MIDI/MAXI-03-SV	165 471