

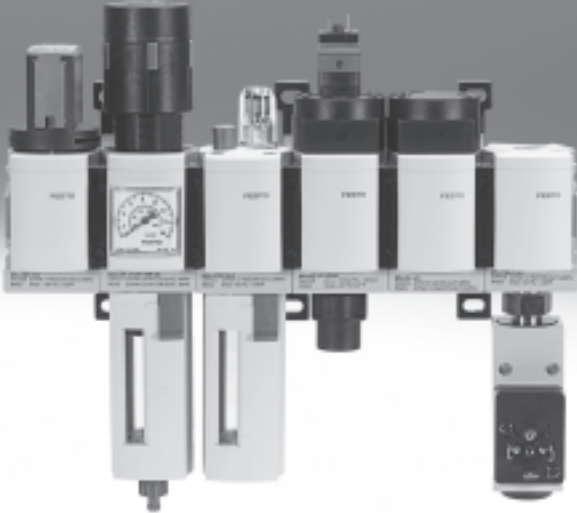

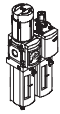

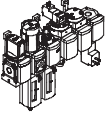

Service unit combinations MSB, MS series



Service unit combinations MSB, MS series

Product range overview – MS series service units

Type	Size	Pneumatic connection in housing	Connecting plate	Pressure regulation range [bar]						Grade of filtration [µm]				
				0.05	0.05	0.1	0.3	0.1	0.5					
				0.01	1	5	40	
Code			AG...	D2	D4	D5	D6	D7	D8	A	B	C	E	
Service units														
MSB-FRC 	4	G1/8, G1/4	G1/8, G1/4, G3/8	-	-	-	■	■	-	-	-	■	■	
	6	G1/4, G3/8, G1/2	G1/4, G3/8, G1/2, G3/4	-	-	-	■	■	-	-	-	■	■	
	9	-												
	12	-												
Service unit combinations (further variants can be ordered using the configurator → Internet: msb4, msb6 or msb9)														
MSB 	4	G1/4	G1/8, G1/4, G3/8	-	-	-	■	■	-	-	-	■	■	
	6	G1/2	G1/4, G3/8, G1/2, G3/4	-	-	-	■	■	-	-	-	■	■	
	9	-												
	12	-												
Individual devices														
Filter regulators MS-LFR 	4	G1/8, G1/4	G1/8, G1/4, G3/8	-	-	■	■	■	-	-	-	■	■	
	6	G1/4, G3/8, G1/2	G1/4, G3/8, G1/2, G3/4	-	-	■	■	■	■	-	-	■	■	
	9	-												
	12	-	G1, G1 1/4, G1 1/2, G2	-	-	-	■	■	■	-	-	■	■	
Filters MS-LF 	4	G1/8, G1/4	G1/8, G1/4, G3/8	-	-	-	-	-	-	-	-	■	■	
	6	G1/4, G3/8, G1/2	G1/4, G3/8, G1/2, G3/4	-	-	-	-	-	-	-	-	■	■	
	9	-												
	12	-	G1, G1 1/4, G1 1/2, G2	-	-	-	-	-	-	-	-	■	■	
Fine and micro filters MS-LFM 	4	G1/8, G1/4	G1/8, G1/4, G3/8	-	-	-	-	-	-	■	■	-	-	
	6	G1/4, G3/8, G1/2	G1/4, G3/8, G1/2, G3/4	-	-	-	-	-	-	■	■	-	-	
	9	G3/4, G1	G1/2, G3/4, G1, G1 1/4, G1 1/2	-	-	-	-	-	-	■	■	-	-	
	12	-	G1, G1 1/4, G1 1/2, G2	-	-	-	-	-	-	■	■	-	-	
Activated carbon filters MS-LFX 	4	G1/8, G1/4	G1/8, G1/4, G3/8	-	-	-	-	-	-	-	-	-	-	
	6	G1/4, G3/8, G1/2	G1/4, G3/8, G1/2, G3/4	-	-	-	-	-	-	-	-	-	-	
	9	G3/4, G1	G1/2, G3/4, G1, G1 1/4, G1 1/2	-	-	-	-	-	-	-	-	-	-	
	12	-	G1, G1 1/4, G1 1/2, G2	-	-	-	-	-	-	-	-	-	-	
Water separators MS-LWS 	4	-												
	6	G1/4, G3/8, G1/2	G1/4, G3/8, G1/2, G3/4	-	-	-	-	-	-	-	-	-	-	
	9	-												
	12	-												

Service unit combinations MSB, MS series

Product range overview – MS series service units

Type	Size	Bowl guard		Condensate drains				Pressure indicator					Actuator lock		Options		→ Page/ Internet
		Plastic bowl with plastic bowl guard	Metal bowl	Manual rotary	Semi-automatic	Fully automatic	External, fully automatic, electrical	Cover plate (without pressure gauge)	Integrated MS pressure gauge	Adapter plate for EN pressure gauge G1/8	Adapter plate for EN pressure gauge G1/4	Pressure sensor	Rotary knob, lockable	Rotary knob, long	Silencer	Flow direction from right to left	
Code		R	U	M	H	V	E...	VS	AG	A8	A4	AD...	AS	LD	S	Z	
Service units																	
MSB-FRC	4	■	-	■	-	■	-	-	■	-	-	-	■	-	-	■	msb4
	6	■	■	■	-	■	-	-	■	-	-	-	■	-	-	■	msb6
	9	-	-	-	-	-	-	-	-	-	-	-	-	-	-	-	-
	12	-	-	-	-	-	-	-	-	-	-	-	-	-	-	-	-
Service unit combinations																	
MSB	4	■	■	■	-	■	-	-	■	-	-	-	■	-	-	■	8
	6	■	■	■	-	■	-	-	■	-	-	-	■	-	-	■	8
	9	-	-	-	-	-	-	-	-	-	-	-	-	-	-	-	-
	12	-	-	-	-	-	-	-	-	-	-	-	-	-	-	-	-
Individual devices																	
Filter regulators MS-LFR	4	■	■	■	■	■	-	■	■	■	■	■	■	■	-	■	ms4-lfr
	6	■	■	■	■	■	■	■	■	-	■	■	■	■	-	■	ms6-lfr
	9	-	-	-	-	-	-	-	-	-	-	-	-	-	-	-	-
	12	-	■	■	-	■	■	■	■	-	■	-	■	■	-	■	ms12-lfr
Filters MS-LF	4	■	■	■	■	■	-	-	-	-	-	-	-	-	-	■	ms4-lf
	6	■	■	■	■	■	■	-	-	-	-	-	-	-	-	■	ms6-lf
	9	-	-	-	-	-	-	-	-	-	-	-	-	-	-	-	-
	12	-	■	■	-	■	■	-	-	-	-	-	-	-	-	■	ms12-lf
Fine and micro filters MS-LFM	4	■	■	■	■	■	-	-	-	-	-	-	-	-	-	■	ms4-lfm
	6	■	■	■	■	■	■	-	-	-	-	-	-	-	-	■	ms6-lfm
	9	-	■	■	-	■	■	-	-	-	-	-	-	-	-	■	ms9-lfm
	12	-	■	■	-	■	■	-	-	-	-	-	-	-	-	■	ms12-lfm
Activated carbon filters MS-LFX	4	■	■	-	-	-	-	-	-	-	-	-	-	-	-	■	ms4-lfx
	6	■	■	-	-	-	-	-	-	-	-	-	-	-	-	■	ms6-lfx
	9	-	■	-	-	-	-	-	-	-	-	-	-	-	-	■	ms9-lfx
	12	-	■	-	-	-	-	-	-	-	-	-	-	-	-	■	ms12-lfx
Water separators MS-LWS	4	-	-	-	-	-	-	-	-	-	-	-	-	-	-	-	-
	6	-	■	-	-	■	■	-	-	-	-	-	-	-	-	■	ms6-lws
	9	-	-	-	-	-	-	-	-	-	-	-	-	-	-	-	-
	12	-	-	-	-	-	-	-	-	-	-	-	-	-	-	-	-

Service unit combinations MSB, MS series



Product range overview – MS series service units

Type	Size	Pneumatic connection in housing	Connecting plate	Pressure regulation range [bar]						Supply voltage			
				0.05 ... 0.7	0.05 ... 2.5	0.1 ... 4	0.3 ... 7	0.1 ... 12	0.5 ... 16	24 V DC, connection pattern to EN 175301	24 V DC, connection pattern M12 to DESINA	110 V AC, connection pattern to EN 175301	230 V AC, connection pattern to EN 175301
Code			AG...	D2	D4	D5	D6	D7	D8	V24	V24P	V110	V230
Individual devices													
Pressure regulators MS-LR		4	G1/8, G1/4	G1/8, G1/4, G3/8	-	-	■	■	■	-	-	-	-
		6	G1/4, G3/8, G1/2	G1/4, G3/8, G1/2, G3/4	-	-	■	■	■	■	-	-	-
		9	-										
		12	-	G1, G1 1/4, G1 1/2, G2	-	-	-	■	■	■	-	-	-
Pressure regulators MS-LRB		4	G1/4	G1/8, G1/4, G3/8	-	-	■	■	■	-	-	-	-
		6	G1/2	G1/4, G3/8, G1/2, G3/4	-	-	■	■	■	■	-	-	-
		9	-										
		12	-										
Precision pressure regulators MS-LRP		4	-										
		6	G1/4, G3/8, G1/2	G1/4, G3/8, G1/2, G3/4	■	■	■	-	■	-	-	-	-
		9	-										
		12	-										
Precision pressure regulators MS-LRPB		4	-										
		6	G1/2	G1/4, G3/8, G1/2, G3/4	■	■	■	-	■	-	-	-	-
		9	-										
		12	-										
Electrical pressure regulators MS-LRE		4	-										
		6	G1/4, G3/8, G1/2	G1/4, G3/8, G1/2, G3/4	-	-	■	■	■	■	-	-	-
		9	-										
		12	-										
Lubricators MS-LOE		4	G1/8, G1/4	G1/8, G1/4, G3/8	-	-	-	-	-	-	-	-	-
		6	G1/4, G3/8, G1/2	G1/4, G3/8, G1/2, G3/4	-	-	-	-	-	-	-	-	-
		9	-										
		12	-	G1, G1 1/4, G1 1/2, G2	-	-	-	-	-	-	-	-	-
Electrical on-off valves MS-EM(1)		4	G1/8, G1/4	G1/8, G1/4, G3/8	-	-	-	-	-	-	-	-	-
		6	G1/4, G3/8, G1/2	G1/4, G3/8, G1/2, G3/4	-	-	-	-	-	-	-	-	-
		9	-										
		12	-	G1, G1 1/4, G1 1/2, G2	-	-	-	-	-	-	-	-	-
Electrical on-off valves MS-EE		4	G1/8, G1/4	G1/8, G1/4, G3/8	-	-	-	-	-	-	■	-	■
		6	G1/4, G3/8, G1/2	G1/4, G3/8, G1/2, G3/4	-	-	-	-	-	-	■	-	■
		9	-										
		12	-	G1, G1 1/4, G1 1/2, G2	-	-	-	-	-	-	■	■	■
Electrical soft-start valves MS-DL		4	G1/8, G1/4	G1/8, G1/4, G3/8	-	-	-	-	-	-	-	-	-
		6	G1/4, G3/8, G1/2	G1/4, G3/8, G1/2, G3/4	-	-	-	-	-	-	-	-	-
		9	-										
		12	-	G1, G1 1/4, G1 1/2, G2	-	-	-	-	-	-	-	-	-
Electrical soft-start valves MS-DE		4	G1/8, G1/4	G1/8, G1/4, G3/8	-	-	-	-	-	-	■	-	■
		6	G1/4, G3/8, G1/2	G1/4, G3/8, G1/2, G3/4	-	-	-	-	-	-	■	-	■
		9	-										
		12	-	G1, G1 1/4, G1 1/2, G2	-	-	-	-	-	-	■	■	■
Soft start and exhaust valves MS-SV		4	-										
		6	G1/2	G1/4, G3/8, G1/2, G3/4	-	-	-	-	-	-	■	-	-
		9	-										
		12	-										

Service unit combinations MSB, MS series

Product range overview – MS series service units

Type	Size	Bowl guard		Pressure indicator				Actuator lock		Options		→ Page/ Internet	
		Plastic bowl with plastic bowl guard	Metal bowl	Cover plate (without pressure gauge)	Integrated MS pressure gauge	Adapter plate for EN pressure gauge G1/8	Adapter plate for EN pressure gauge G1/4	Pressure sensor	Rotary knob, lockable	Rotary knob, long	Silencer		Flow direction from right to left
Code		R	U	VS	AG	A8	A4	AD...	AS	LD	S	Z	
Individual devices													
Pressure regulators MS-LR	4	-	-	■	■	■	■	■	■	■	-	■	ms4-lr
	6	-	-	■	■	-	■	■	■	■	-	■	ms6-lr
	9	-	-	-	-	-	-	-	-	-	-	-	-
	12	-	-	■	■	-	■	-	■	■	-	■	ms12-lr
Pressure regulators MS-LRB	4	-	-	■	■	■	■	■	■	■	-	■	ms4-lrb
	6	-	-	■	■	-	■	■	■	■	-	■	ms6-lrb
	9	-	-	-	-	-	-	-	-	-	-	-	-
	12	-	-	-	-	-	-	-	-	-	-	-	-
Precision pressure regulators MS-LRP	4	-	-	-	-	-	-	-	-	-	-	-	-
	6	-	-	■	-	■	■	■	■	■	-	■	ms6-lrp
	9	-	-	-	-	-	-	-	-	-	-	-	-
	12	-	-	-	-	-	-	-	-	-	-	-	-
Precision pressure regulators MS-LRPB	4	-	-	-	-	-	-	-	-	-	-	-	-
	6	-	-	■	-	■	■	■	■	■	-	■	ms6-lrpb
	9	-	-	-	-	-	-	-	-	-	-	-	-
	12	-	-	-	-	-	-	-	-	-	-	-	-
Electrical pressure regulators MS-LRE	4	-	-	-	-	-	-	-	-	-	-	-	-
	6	-	-	■	■	-	■	-	-	-	-	■	ms6-lre
	9	-	-	-	-	-	-	-	-	-	-	-	-
	12	-	-	-	-	-	-	-	-	-	-	-	-
Lubricators MS-LOE	4	■	■	-	-	-	-	-	-	-	-	■	ms4-loe
	6	■	■	-	-	-	-	-	-	-	-	■	ms6-loe
	9	-	-	-	-	-	-	-	-	-	-	-	-
	12	-	■	-	-	-	-	-	-	-	-	■	ms12-loe
Electrical on-off valves MS-EM(1)	4	-	-	■	■	■	■	■	-	-	■	■	ms4-em1
	6	-	-	■	■	-	■	■	-	-	■	■	ms6-em1
	9	-	-	-	-	-	-	-	-	-	-	-	-
	12	-	-	■	■	-	■	-	-	-	■	■	ms12-em
Electrical on-off valves MS-EE	4	-	-	■	■	■	■	■	-	-	■	■	ms4-ee
	6	-	-	■	■	-	■	■	-	-	■	■	ms6-ee
	9	-	-	-	-	-	-	-	-	-	-	-	-
	12	-	-	■	■	-	■	-	-	-	■	■	ms12-ee
Electrical soft-start valves MS-DL	4	-	-	■	■	■	■	■	-	-	-	■	ms4-dl
	6	-	-	■	■	-	■	■	-	-	-	■	ms6-dl
	9	-	-	-	-	-	-	-	-	-	-	-	-
	12	-	-	■	■	-	■	-	-	-	-	■	ms12-dl
Electrical soft-start valves MS-DE	4	-	-	■	■	■	■	■	-	-	-	■	ms4-de
	6	-	-	■	■	-	■	■	-	-	-	■	ms6-de
	9	-	-	-	-	-	-	-	-	-	-	-	-
	12	-	-	■	■	-	■	-	-	-	-	■	ms12-de
Soft start and exhaust valves MS-SV	4	-	-	-	-	-	-	-	-	-	-	-	-
	6	-	-	■	■	-	■	■	-	-	■	■	ms6-sv
	9	-	-	-	-	-	-	-	-	-	-	-	-
	12	-	-	-	-	-	-	-	-	-	-	-	-

Service unit combinations MSB, MS series

Product range overview – MS series service units

Type	Size	Pneumatic connection in housing	Connecting plate	Pressure regulation range [bar]				Supply voltage				
				0.1 ... 4	0.3 ... 7	0.1 ... 12	0.5 ... 16	24 V DC, connection pattern to EN 175301	24 V DC, connection pattern M12 to DESINA	110 V AC, connection pattern to EN 175301	230 V AC, connection pattern to EN 175301	
Code			AG...	D5	D6	D7	D8	V24	V24P	V110	V230	
Individual devices												
Membrane air dryers MS-LDM1		4	G1/8, G1/4	G1/8, G1/4, G3/8	-	-	-	-	-	-	-	-
		6	G1/4, G3/8, G1/2	G1/4, G3/8, G1/2, G3/4	-	-	-	-	-	-	-	-
		9	-	-	-	-	-	-	-	-	-	-
		12	-	-	-	-	-	-	-	-	-	-
Branching modules MS-FRM		4	G1/8, G1/4	G1/8, G1/4, G3/8	-	-	-	-	-	-	-	-
		6	G1/4, G3/8, G1/2	G1/4, G3/8, G1/2, G3/4	-	-	-	-	-	-	-	-
		9	-	-	-	-	-	-	-	-	-	-
		12	-	G1, G1 1/4, G1 1/2, G2	-	-	-	-	-	-	-	-
Distributor blocks MS-FRM-FRZ		4	G1/4	-	-	-	-	-	-	-	-	-
		6	G1/2	-	-	-	-	-	-	-	-	-
		9	-	-	-	-	-	-	-	-	-	-
		12	-	-	-	-	-	-	-	-	-	-
Flow sensors MS-SFE		4	-	-	-	-	-	-	-	-	-	-
		6	G1/2	G1/2	-	-	-	-	-	-	-	-
		9	-	-	-	-	-	-	-	-	-	-
		12	-	-	-	-	-	-	-	-	-	-
Flow sensors SFAM		4	-	-	-	-	-	-	-	-	-	-
		6	G1/2	G1/2	-	-	-	-	-	-	-	-
		9	-	-	-	-	-	-	-	-	-	-
		12	-	-	-	-	-	-	-	-	-	-

Service unit combinations MSB, MS series

Product range overview – MS series service units

Type	Size	Bowl guard		Pressure indicator				Switch output		Options		→ Page/ Internet	
		Plastic bowl with plastic bowl guard	Metal bowl	Cover plate (without pressure gauge)	Integrated MS pressure gauge	Adapter plate for EN pressure gauge G1/8	Adapter plate for EN pressure gauge G1/4	Pressure sensor	2x PNP	2x NPN	Silencer		Flow direction from right to left
Code		R	U	VS	AG	A8	A4	AD...	P2/2S	N2/2S	S	Z/R	
Individual devices													
Membrane air dryers MS-LDM1	4	-	■	-	-	-	-	-	-	-	-	■	ms4-ldm1
	6	-	■	-	-	-	-	-	-	-	-	■	ms6-ldm1
	9	-	-	-	-	-	-	-	-	-	-	-	-
	12	-	-	-	-	-	-	-	-	-	-	-	-
Branching modules MS-FRM	4	-	-	■	■	■	■	■	-	-	-	■	ms4-frm
	6	-	-	■	■	-	■	■	-	-	-	■	ms6-frm
	9	-	-	-	-	-	-	-	-	-	-	-	-
	12	-	-	■	-	-	-	-	-	-	-	-	ms12-frm
Distributor blocks MS-FRM-FRZ	4	-	-	-	-	-	-	-	-	-	-	■	ms4-frm
	6	-	-	-	-	-	-	-	-	-	-	■	ms6-frm
	9	-	-	-	-	-	-	-	-	-	-	-	-
	12	-	-	-	-	-	-	-	-	-	-	-	-
Flow sensors MS-SFE	4	-	-	-	-	-	-	-	-	-	-	-	-
	6	-	-	-	-	-	-	-	■	■	-	■ ¹⁾	ms6-sfe
	9	-	-	-	-	-	-	-	-	-	-	-	-
	12	-	-	-	-	-	-	-	-	-	-	-	-
Flow sensors SFAM	4	-	-	-	-	-	-	-	-	-	-	-	-
	6	-	-	-	-	-	-	-	■	■	-	■	sfam
	9	-	-	-	-	-	-	-	-	-	-	-	-
	12	-	-	-	-	-	-	-	-	-	-	-	-

1) Can only be ordered using the configurator → Internet: ms6-sfe

Service unit combinations MSB4/MSB6, MS series

Product range overview

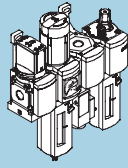
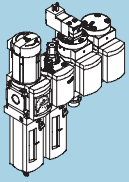
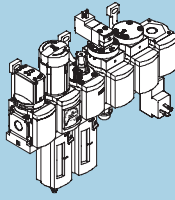
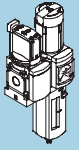
Combinations					
consisting of:					
On-off valve manually actuated	EM1	■	-	■	■
Filter regulator with pressure gauge, lockable	LFR	■	■	■	■
Pressure regulator with pressure gauge, lockable	LR	-	-	-	-
Filter	LF	-	-	-	-
Lubricator	LOE	■	■	■	-
On-off valve solenoid actuated	EE	-	■	■	-
Soft-start valve pneumatically actuated	DL	-	■	■	-
Branching module with pressure switch	FRM	■	-	■	-
Mounting bracket	WP	■	■	■	■
Type codes → Page/Internet	10	10	10	10	
Technical data → Page/Internet	11	14	18	22	

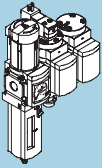
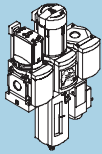
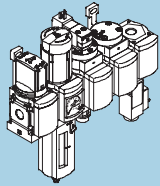
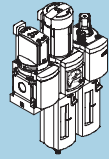
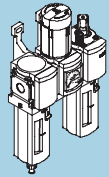
Combinations						
consisting of:						
On-off valve manually actuated	EM1	-	■	■	■	-
Filter regulator with pressure gauge, lockable	LFR	■	■	■	■	-
Pressure regulator with pressure gauge, lockable	LR	-	-	-	-	■
Filter	LF	-	-	-	-	■
Lubricator	LOE	-	-	-	■	■
On-off valve solenoid actuated	EE	■	-	■	-	-
Soft-start valve pneumatically actuated	DL	■	-	■	-	-
Branching module with pressure switch	FRM	-	■	■	-	-
Mounting bracket	WP	■	■	■	■	■
Type codes → Page/Internet	10	10	10	10	10	
Technical data → Page/Internet	25	29	32	36	39	

Service unit combinations MSB4/MSB6, MS series

Peripherals overview

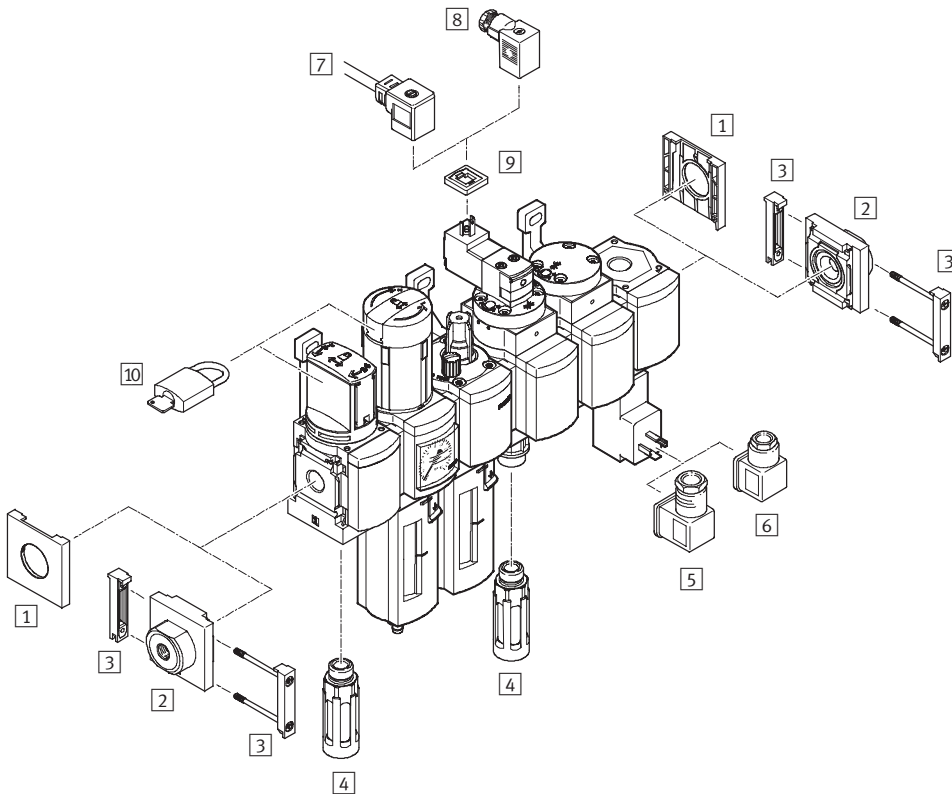

-  - Note
 The choice of accessories depends on the selected service unit combination.
 Range of accessories
 → Peripherals pages of the individual devices

Mounting attachments and accessories		→ Page/Internet
1	Cover cap MS4/6-END	ms4-end, ms6-end
2	Connecting plate MS4/6-AG...	ms4-ag, ms6-ag
3	Module connector MS4/6-MV	ms4-mv, ms6-mv
4	Silencer U	43
5	Angled socket PEV-1/4-WD-LED	43
6	Plug socket MSSD-C-4P	43
7	Plug socket with cable KMEB	43
8	Plug socket MSSD-EB	43
9	Illuminating seal MEB-LD	43
10	Padlock LRVS-D	43
-	Mounting bracket MS4/6-WP/WPB/WPE/WPM	ms4-wp, ms6-wp

Service unit combinations MSB4/MSB6, MS series

Type codes

MSB 6 - 1/2 : H7 N3 M2 - WP

Series

MSB	Service unit combination
-----	--------------------------

Size

4	Grid dimension 40 mm
6	Grid dimension 62 mm

Pneumatic connection

MSB4	
1/4	Thread G1/4
MSB6	
1/2	Thread G1/2

Service unit combination

On-off valve → Internet: ms4-em1, ms6-em1	
C3	MS...-EM1
Filters → Internet: ms4-lf, ms6-lf	
H1	MS...-LF-ERV
H2	MS...-LF-ERM
H3	MS...-LF-CRM
H4	MS...-LF-CRV
H7	MS...-LF-EUV
H8	MS...-LF-EUM
Filter regulator → Internet: ms4-lfr, ms6-lfr	
J1	MS...-LFR-D7-ERM-AS
J2	MS...-LFR-D7-ERV-AS
J3	MS...-LFR-D7-CRM-AS
J4	MS...-LFR-D7-CRV-AS
Pressure regulator → Internet: ms4-lr, ms6-lr	
N2	MS...-LR-D6-AS
N3	MS...-LR-D7-AS
Soft-start valve → Internet: ms4-dl, ms6-dl	
A1	MS...-DL
Lubricator → Internet: ms4-loe, ms6-loe	
M1	MS...-LOE-R
M2	MS...-LOE-U
On-off valve → Internet: ms4-ee, ms6-ee	
D1	MS...-EE-V24
D7	MS...-EE-10V24
Branching module → Internet: ms4-frm, ms6-frm	
F3	MS...-FRM-Y

Type of mounting

WP	Mounting bracket
----	------------------

Further variants can be ordered using the modular system → www.festo.com

- Connection size
- Connecting plates
- Service unit equipment
- Alternative flow direction

Service unit combinations MSB4/MSB6, MS series

Technical data – Combination 1

Function

With condensate drain
manual rotary

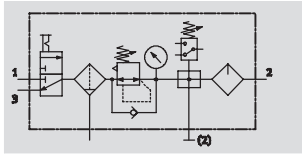

With condensate drain
fully automatic

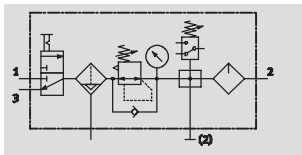

- Flow rate
900 ... 3,300 l/min
- Temperature range
-10 ... +60 °C
- Pressure regulation range
1 ... 12 bar



- On-off valve MS...-EM1 manually actuated
- Filter regulator MS...-LFR-D7
- Branching module MS...-FRM-Y with pressure switch without display
- Lubricator MS...-LOE-R
- Mounting bracket MS...-WP

- For filtered and lubricated compressed air
- Supply pressure can be opened and closed
- Output pressure is infinitely adjustable within the pressure regulation range
- The unit is vented when switched off
- Electrical pressure monitoring with adjustable switching pressure
- Removal of filtered and unlubricated compressed air at the branching module connections

General technical data		
Size	MSB4	MSB6
Pneumatic connection 1, 2, 3	G1/4	G1/2
Regulating function	With primary pressure compensation	
	With return flow function	
	With secondary venting	
	Output pressure constant	
Type of mounting	Via accessories	
Assembly position	Vertical ±5°	
Grade of filtration [µm]	5 (air purity class at the output 3.7.- to DIN ISO 8573-1)	
	40 (air purity class at the output 5.7.- to DIN ISO 8573-1)	
Bowl guard	Plastic bowl guard	
Condensate drain	Manual rotary	
	Fully automatic	
Actuator lock	Rotary knob with detent	
	Lockable with accessories	
Pressure regulation range [bar]	1 ... 12	
Pressure indicator	With pressure gauge	

- | - Note: This product conforms with the ISO 1179-1 standard and the ISO 228-1 standard.

Standard nominal flow rate qnN [l/min]		
Size	MSB4	MSB6
Grade of filtration	5 µm	900
	40 µm	950
		3,200
		3,300

Service unit combinations MSB4/MSB6, MS series

Technical data – Combination 1

Operating and environmental conditions				
Condensate drain		Manual rotary		Fully automatic
Size	MSB4	MSB6	MSB4	MSB6
Supply pressure [bar]	1.5 ... 14	1.5 ... 18	1.5 ... 12	1.5 ... 12
Operating medium	Filtered compressed air, lubricated or unlubricated, grade of filtration 40 µm			
Ambient temperature [°C]	-10 ... +60		+5 ... +60	
Temperature of medium [°C]	-10 ... +60		+5 ... +60	
Storage temperature [°C]	-10 ... +60		-10 ... +60	
Corrosion resistance CRC ¹⁾	2			

1) Corrosion resistance class 2 according to Festo standard 940 070
 Components requiring moderate corrosion resistance. Externally visible parts with primarily decorative surface requirements which are in direct contact with a normal industrial environment or media such as coolants or lubricating agents.

Weights [g]		
Size	MSB4	MSB6
Service unit combination	1,700	2,550
Mounting bracket	40	76

-  - Note
 Materials → Technical data of the individual devices

Standard flow rate qn as a function of output pressure p2

Pressure regulation range 1 ... 12 bar Grade of filtration 5 µm Grade of filtration 40 µm
 MSB4-1/4

Primary pressure p1 = 10 bar

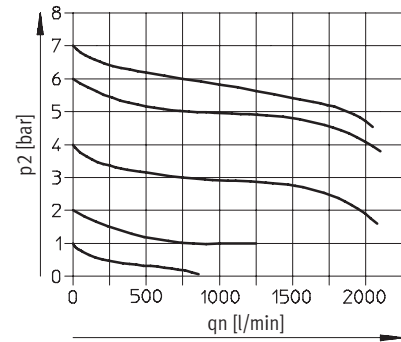
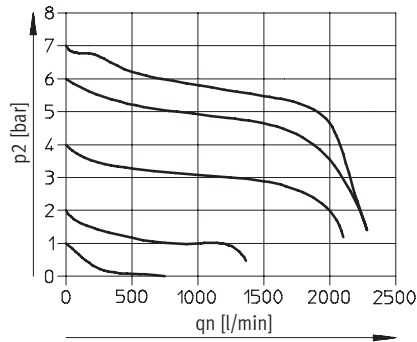

MSB6-1/2

Primary pressure p1 = 10 bar

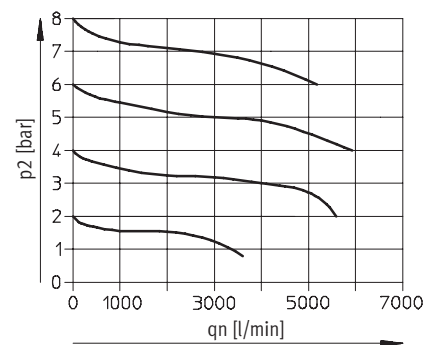
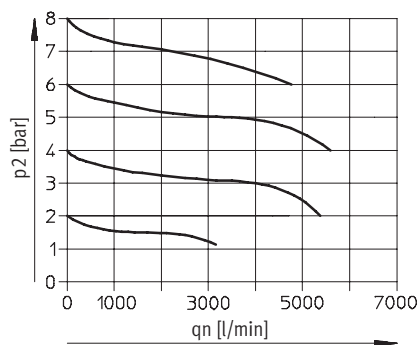

Service unit combinations MSB4/MSB6, MS series

Technical data – Combination 1

Dimensions

Download CAD data → www.festo.com

With pressure gauge, display unit [bar]

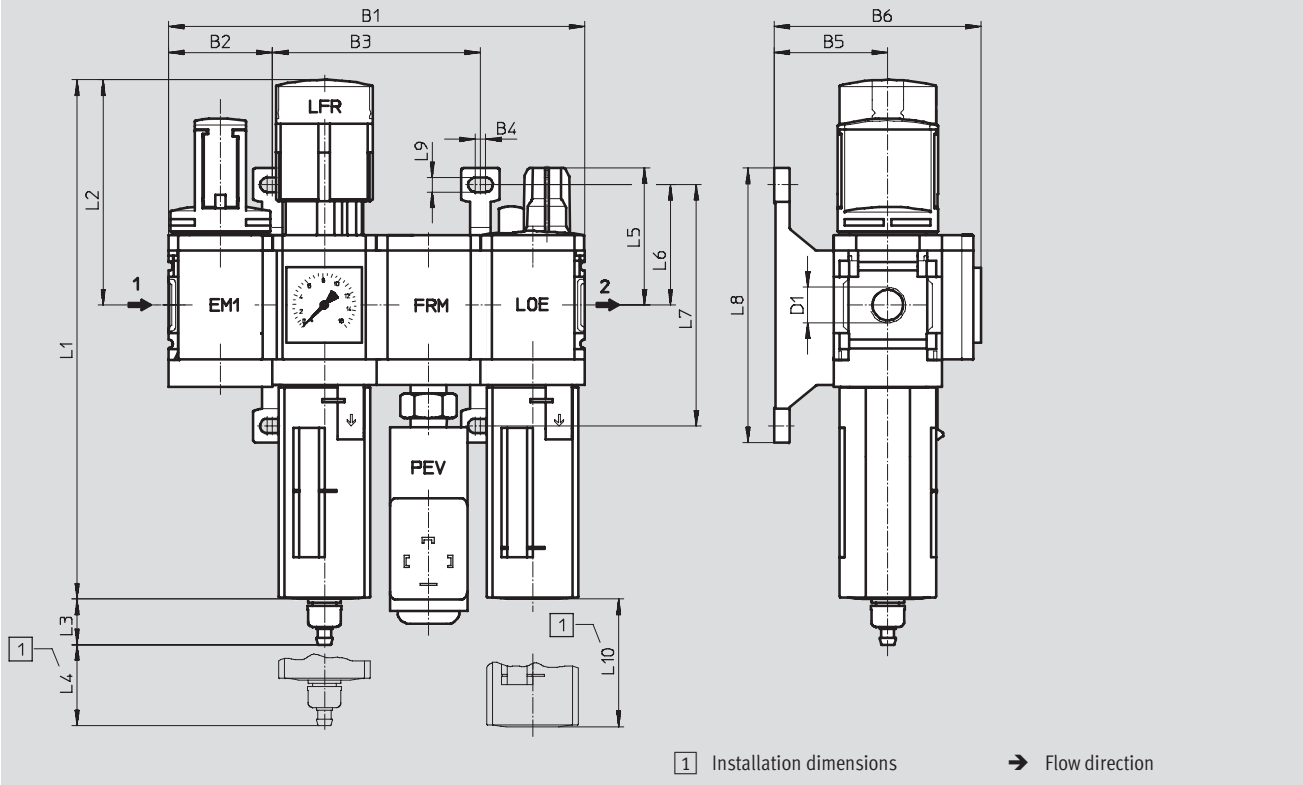

Type	B1	B2	B3	B4	B5	B6	D1	L1	L2
MSB4	160.8	40.2	80.4	4	44	80	G $\frac{1}{4}$	201	87
MSB6	248	62	124	4.5	54	100	G $\frac{1}{2}$	285	134.5

Type	L3 Condensate drain		L4	L5	L6	L7	L8	L9	L10
	manual rotary	fully automatic							
MSB4	17.7	20.4	25	53	46.5	93.2	106	5.6	80
MSB6	15.8	18.5	68	66	71	142	158	6.6	130

Note: This product conforms with the ISO 1179-1 standard and the ISO 228-1 standard.

Ordering data

Pressure regulation range 1... 12 bar

Size	Condensate drain	Connection	Grade of filtration 5 μ m		Grade of filtration 40 μ m	
			Part No.	Type	Part No.	Type
Plastic bowl guard						
MSB4	manual rotary	G $\frac{1}{4}$	542307	MSB4- $\frac{1}{4}$:C3J3F3M1-WP	542295	MSB4- $\frac{1}{4}$:C3J1F3M1-WP
	fully automatic	G $\frac{1}{4}$	542313	MSB4- $\frac{1}{4}$:C3J4F3M1-WP	542301	MSB4- $\frac{1}{4}$:C3J2F3M1-WP
MSB6	manual rotary	G $\frac{1}{2}$	542283	MSB6- $\frac{1}{2}$:C3J3F3M1-WP	542271	MSB6- $\frac{1}{2}$:C3J1F3M1-WP
	fully automatic	G $\frac{1}{2}$	542289	MSB6- $\frac{1}{2}$:C3J4F3M1-WP	542277	MSB6- $\frac{1}{2}$:C3J2F3M1-WP

Service unit combinations MSB4/MSB6, MS series

Technical data – Combination 2

Function
With condensate drain
manual rotary

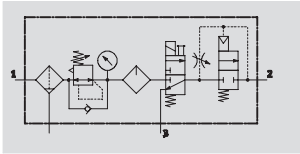

With condensate drain
fully automatic

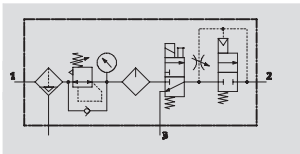

- Flow rate
550 ... 2,000 l/min
- Temperature range
-10 ... +60 °C
- Pressure regulation range
4 ... 12 bar



- Filter regulator MS...-LFR-D7
- Lubricator MS...-LOE-R
- On-off valve MS...-EE-10V24 or MS...-EE-V24 solenoid actuated
- Soft-start valve MS...-DL pneumatically actuated
- Mounting bracket MS...-WP

- For filtered and lubricated compressed air
- Output pressure is infinitely adjustable within the pressure regulation range
- Gradual pressure build-up prevents sudden, unpredictable movements
- When supply pressure is closed, quick venting ensures rapid pressure reduction

General technical data		
Size	MSB4	MSB6
Pneumatic connection 1, 2, 3	G1/4	G1/2
Regulating function	With primary pressure compensation	
	With return flow function	
	With secondary venting	
	Output pressure constant	
Type of mounting	Via accessories	
Assembly position	Vertical ±5°	
Grade of filtration [µm]	5 (air purity class at the output 3.7.- to DIN ISO 8573-1)	
	40 (air purity class at the output 5.7.- to DIN ISO 8573-1)	
Bowl guard	Plastic bowl guard	
Condensate drain	Manual rotary	
	Fully automatic	
Actuator lock	Rotary knob with detent	
	Lockable with accessories	
Pressure regulation range [bar]	4 ... 9 (with on-off valve MS...-EE-10V24)	
	4 ... 12 (with on-off valve MS...-EE-V24)	
Pressure indicator	With pressure gauge	
Supply voltage [V DC]	24	

- - Note: This product conforms with the ISO 1179-1 standard and the ISO 228-1 standard.

Standard nominal flow rate qnN [l/min]		
Size	MSB4	MSB6
Grade of filtration	5 µm	1,900
	40 µm	2,000

Service unit combinations MSB4/MSB6, MS series

Technical data – Combination 2

Operating and environmental conditions								
	Pressure regulation range 4 ... 9 bar				Pressure regulation range 4 ... 12 bar			
Condensate drain	Manual rotary		Fully automatic		Manual rotary		Fully automatic	
Size	MSB4	MSB6	MSB4	MSB6	MSB4	MSB6	MSB4	MSB6
Supply pressure [bar]	4.5 ... 10	4.5 ... 10	4.5 ... 10	4.5 ... 10	4.5 ... 14	4.5 ... 18	4.5 ... 12	4.5 ... 12
Operating medium	Filtered compressed air, lubricated or unlubricated, grade of filtration 40 µm							
Ambient temperature [°C]	-10 ... +50		+5 ... +50		-10 ... +60		+5 ... +60	
Temperature of medium [°C]	-10 ... +50		+5 ... +50		-10 ... +60		+5 ... +60	
Storage temperature [°C]	-10 ... +60		-10 ... +60		-10 ... +60		-10 ... +60	
Corrosion resistance CRC ¹⁾	2							

1) Corrosion resistance class 2 according to Festo standard 940 070
 Components requiring moderate corrosion resistance. Externally visible parts with primarily decorative surface requirements which are in direct contact with a normal industrial environment or media such as coolants or lubricating agents.

Weights [g]		
Size	MSB4	MSB6
Service unit combination	1,800	3,000
Mounting bracket	40	76

 - Note
 Materials → Technical data of the individual devices

Standard flow rate qn as a function of output pressure p2
 Pressure regulation range 4 ... 9 bar / 4 ... 12 bar
 MSB4-1/4

Primary pressure p1 = 10 bar

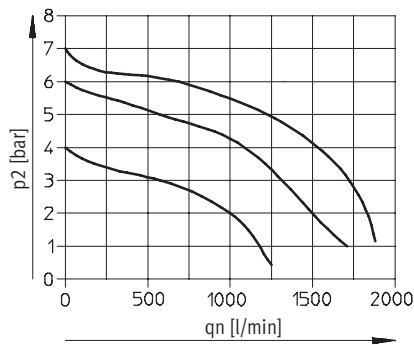

Grade of filtration 40 µm

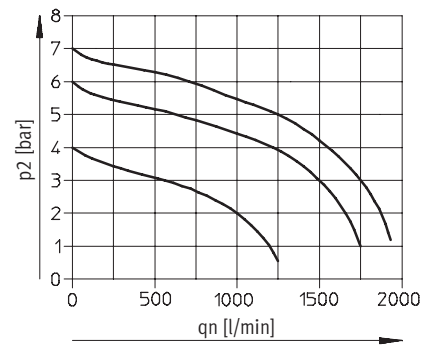

MSB6-1/2

Primary pressure p1 = 10 bar

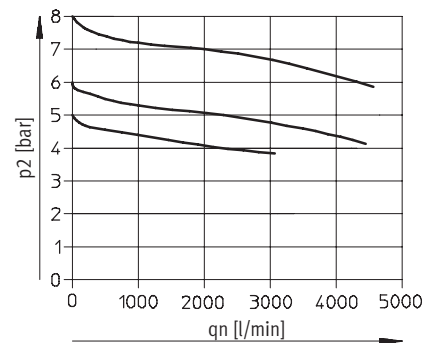
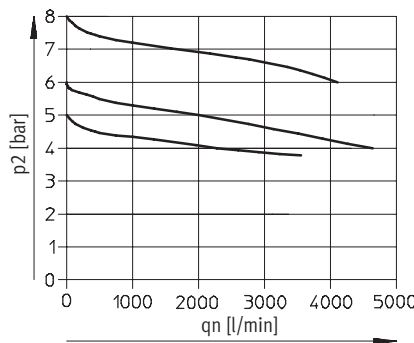

Service unit combinations MSB4/MSB6, MS series

Technical data – Combination 2

Dimensions

Download CAD data → www.festo.com

With pressure gauge, display unit [bar]

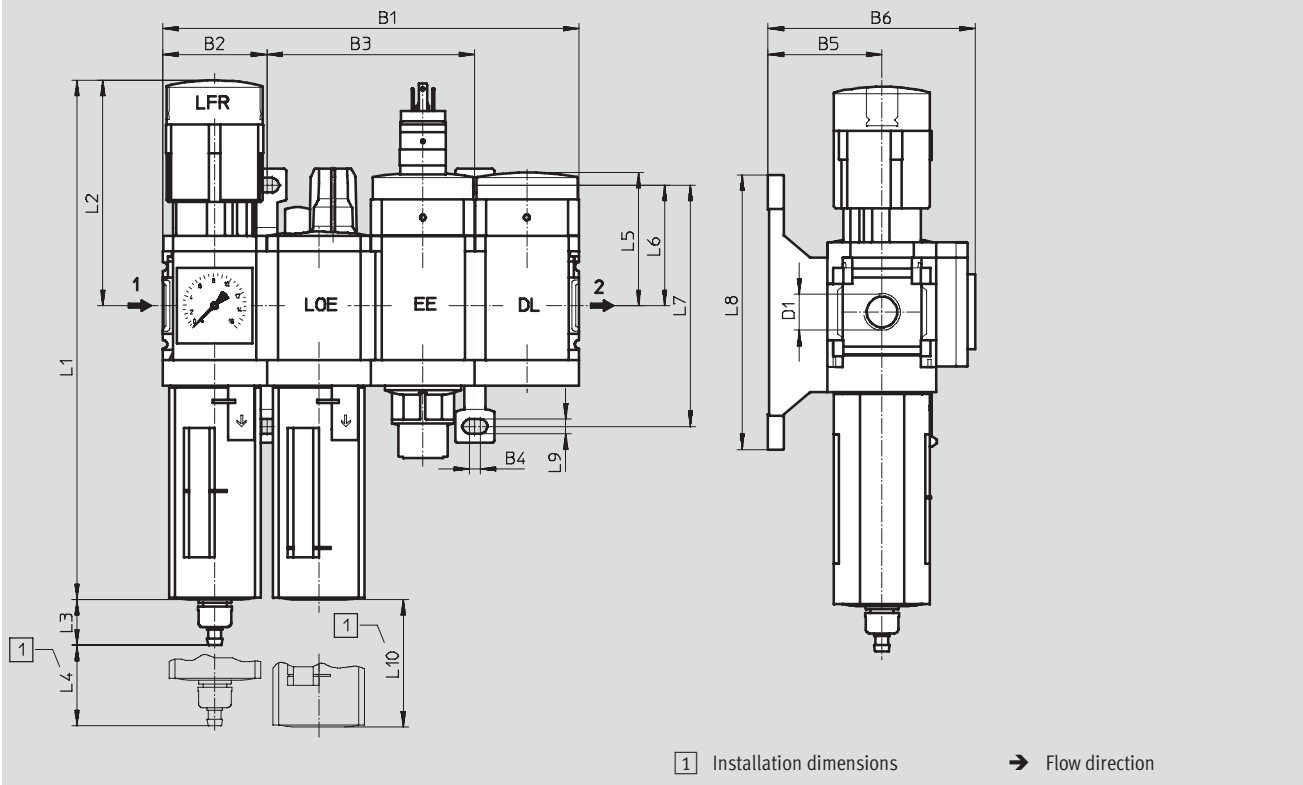

Type	B1	B2	B3	B4	B5	B6	D1	L1	L2
MSB4	160.8	40.2	80.4	4	44	80	G $\frac{1}{4}$	201	87
MSB6	248	62	124	4.5	54	100	G $\frac{1}{2}$	285	134.5

Type	L3 Condensate drain		L4	L5	L6	L7	L8	L9	L10
	manual rotary	fully auto- matic							
MSB4	17.7	20.4	25	51.7	46.5	93.2	106	5.6	80
MSB6	15.8	18.5	68	71	71	142	158	6.6	130

– † – Note: This product conforms with the ISO 1179-1 standard and the ISO 228-1 standard.

Service unit combinations MSB4/MSB6, MS series

FESTO

Technical data – Combination 2

Ordering data						
Pressure regulation range 4 ... 9 bar						
Size	Condensate drain	Connection	Grade of filtration 5 µm		Grade of filtration 40 µm	
			Part No.	Type	Part No.	Type
Plastic bowl guard						
MSB4	manual rotary	G ¹ / ₄	542632	MSB4- ¹ / ₄ :J3M1D7A1-WP	542628	MSB4- ¹ / ₄ :J1M1D7A1-WP
	fully automatic	G ¹ / ₄	542634	MSB4- ¹ / ₄ :J4M1D7A1-WP	542630	MSB4- ¹ / ₄ :J2M1D7A1-WP
MSB6	manual rotary	G ¹ / ₂	542648	MSB6- ¹ / ₂ :J3M1D7A1-WP	542644	MSB6- ¹ / ₂ :J1M1D7A1-WP
	fully automatic	G ¹ / ₂	542650	MSB6- ¹ / ₂ :J4M1D7A1-WP	542646	MSB6- ¹ / ₂ :J2M1D7A1-WP

Ordering data						
Pressure regulation range 4 ... 12 bar						
Size	Condensate drain	Connection	Grade of filtration 5 µm		Grade of filtration 40 µm	
			Part No.	Type	Part No.	Type
Plastic bowl guard						
MSB4	manual rotary	G ¹ / ₄	531106	MSB4- ¹ / ₄ :J3M1D1A1-WP	531102	MSB4- ¹ / ₄ :J1M1D1A1-WP
	fully automatic	G ¹ / ₄	531108	MSB4- ¹ / ₄ :J4M1D1A1-WP	531104	MSB4- ¹ / ₄ :J2M1D1A1-WP
MSB6	manual rotary	G ¹ / ₂	530227	MSB6- ¹ / ₂ :J3M1D1A1-WP	530223	MSB6- ¹ / ₂ :J1M1D1A1-WP
	fully automatic	G ¹ / ₂	530229	MSB6- ¹ / ₂ :J4M1D1A1-WP	530225	MSB6- ¹ / ₂ :J2M1D1A1-WP

Service unit combinations MSB4/MSB6, MS series

Technical data – Combination 3

Function
With condensate drain
manual rotary

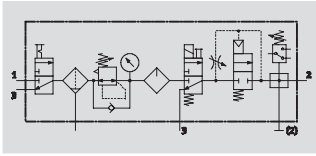

With condensate drain
fully automatic

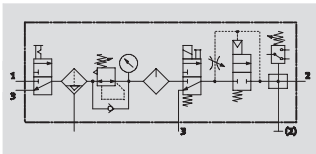

- - Flow rate
550 ... 2,300 l/min
- - Temperature range
-10 ... +60 °C
- - Pressure regulation range
4 ... 12 bar



- On-off valve MS...-EM1 manually actuated
- Filter regulator MS...-LFR-D7
- Lubricator MS...-LOE-R
- On-off valve MS...-EE-10V24 or MS...-EE-V24 solenoid actuated
- Soft-start valve MS...-DL pneumatically actuated
- Branching module MS...-FRM-Y with pressure switch without display
- Mounting bracket MS...-WP

- For filtered and lubricated compressed air
- Supply pressure can be opened and closed
- Output pressure is infinitely adjustable within the pressure regulation range
- Gradual pressure build-up prevents sudden, unpredictable movements
- To shut-off and vent the following device or the system
- Electrical pressure monitoring with adjustable switching pressure

General technical data		
Size	MSB4	MSB6
Pneumatic connection 1, 2, 3	G1/4	G1/2
Regulating function	With primary pressure compensation	
	With return flow function	
	With secondary venting	
	Output pressure constant	
Type of mounting	Via accessories	
Assembly position	Vertical ±5°	
Grade of filtration [µm]	5 (air purity class at the output 3.7.- to DIN ISO 8573-1)	
	40 (air purity class at the output 5.7.- to DIN ISO 8573-1)	
Bowl guard	Plastic bowl guard	
Condensate drain	Manual rotary	
	Fully automatic	
Actuator lock	Rotary knob with detent	
	Lockable with accessories	
Pressure regulation range [bar]	4 ... 9 (with on-off valve MS...-EE-10V24)	
	4 ... 12 (with on-off valve MS...-EE-V24)	
Pressure indicator	With pressure gauge	
Supply voltage [V DC]	24	

- - Note: This product conforms with the ISO 1179-1 standard and the ISO 228-1 standard.

Standard nominal flow rate qnN [l/min]		
Size	MSB4	MSB6
Grade of filtration	5 µm	2,100
	40 µm	2,300

Service unit combinations MSB4/MSB6, MS series

Technical data – Combination 3

Operating and environmental conditions								
	Pressure regulation range 4 ... 9 bar				Pressure regulation range 4 ... 12 bar			
	Manual rotary		Fully automatic		Manual rotary		Fully automatic	
Size	MSB4	MSB6	MSB4	MSB6	MSB4	MSB6	MSB4	MSB6
Supply pressure [bar]	4.5 ... 10	4.5 ... 10	4.5 ... 10	4.5 ... 10	4.5 ... 14	4.5 ... 18	4.5 ... 12	4.5 ... 12
Operating medium	Filtered compressed air, lubricated or unlubricated, grade of filtration 40 µm							
Ambient temperature [°C]	-10 ... +50		+5 ... +50		-10 ... +60		+5 ... +60	
Temperature of medium [°C]	-10 ... +50		+5 ... +50		-10 ... +60		+5 ... +60	
Storage temperature [°C]	-10 ... +60		-10 ... +60		-10 ... +60		-10 ... +60	
Corrosion resistance CRC ¹⁾	2							

1) Corrosion resistance class 2 according to Festo standard 940 070
 Components requiring moderate corrosion resistance. Externally visible parts with primarily decorative surface requirements which are in direct contact with a normal industrial environment or media such as coolants or lubricating agents.

Weights [g]		
Size	MSB4	MSB6
Service unit combination	2,200	4,000
Mounting bracket	40	76

 - Note
 Materials → Technical data of the individual devices

Standard flow rate qn as a function of output pressure p2
 Pressure regulation range 4 ... 9 bar / 4 ... 12 bar
 MSB4-1/4

Primary pressure p1 = 10 bar

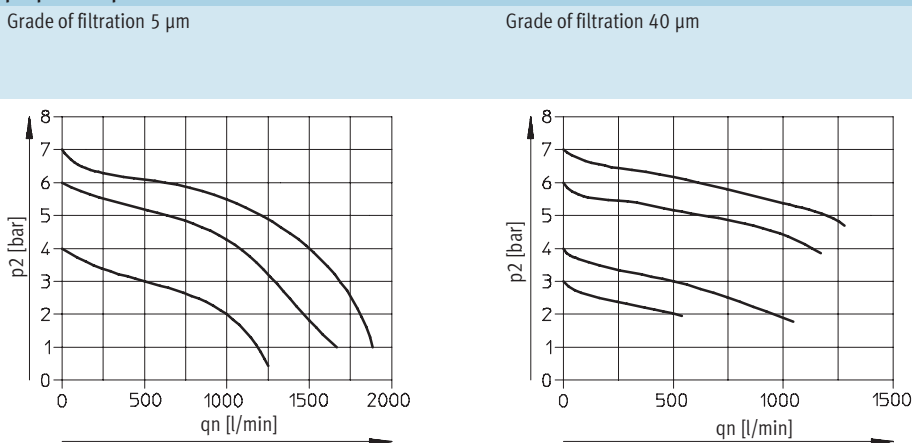

MSB6-1/2

Primary pressure p1 = 10 bar

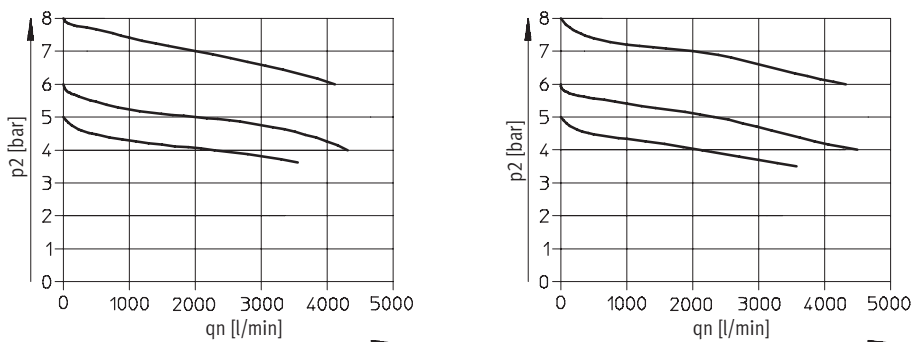

Service unit combinations MSB4/MSB6, MS series

Technical data – Combination 3

Dimensions

Download CAD data → www.festo.com

With pressure gauge, display unit [bar]

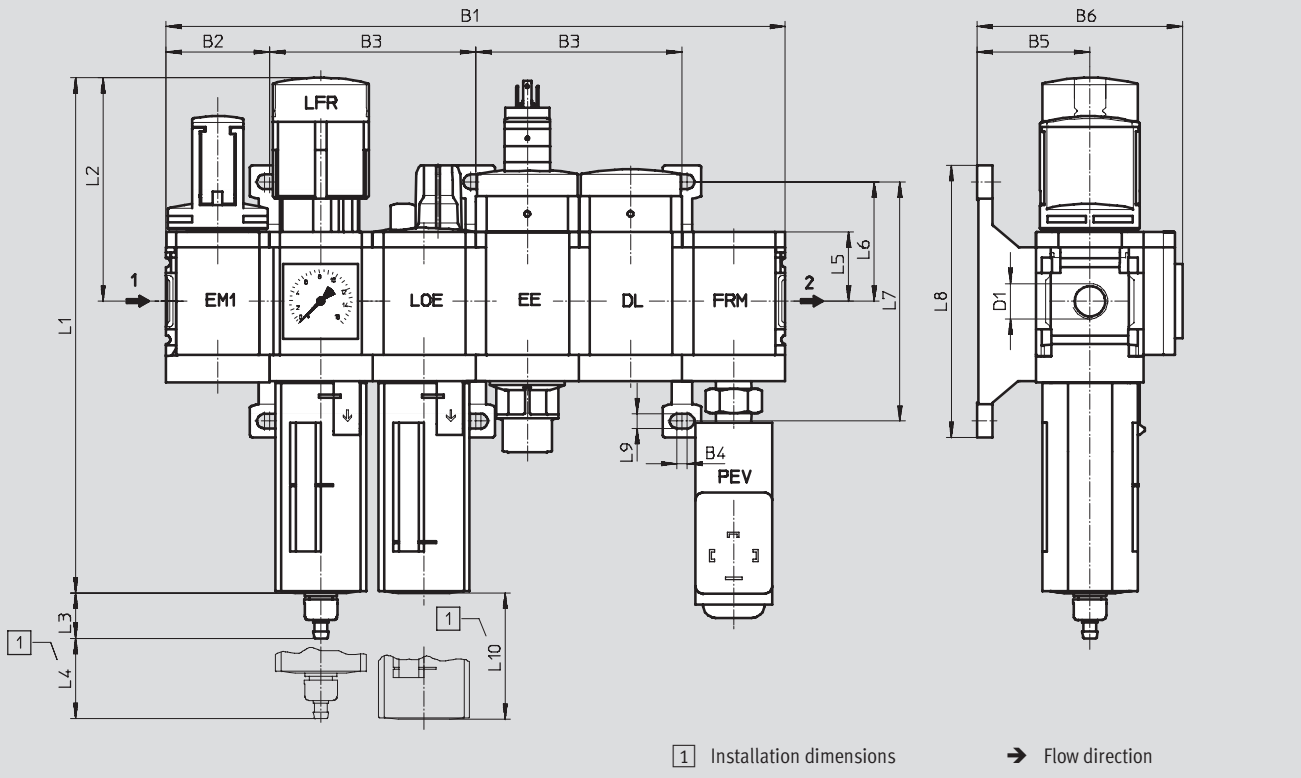

Type	B1	B2	B3	B4	B5	B6	D1	L1	L2
MSB4	241.2	40.2	80.4	4	44	80	G $\frac{1}{4}$	201	87
MSB6	372	62	124	4.5	54	100	G $\frac{1}{2}$	285	134.5

Type	L3 Condensate drain		L4	L5	L6	L7	L8	L9	L10
	manual rotary	fully auto- matic							
MSB4	17.7	20.4	25	27	46.5	93.2	106	5.6	80
MSB6	15.8	18.5	68	39	71	142	158	6.6	130

• - Note: This product conforms with the ISO 1179-1 standard and the ISO 228-1 standard.

Service unit combinations MSB4/MSB6, MS series

FESTO

Technical data – Combination 3

Ordering data						
Pressure regulation range 4 ... 9 bar						
Size	Condensate drain	Connection	Grade of filtration 5 µm		Grade of filtration 40 µm	
			Part No.	Type	Part No.	Type
Plastic bowl guard						
MSB4	manual rotary	G $\frac{1}{4}$	542624	MSB4- $\frac{1}{4}$:C3J3M1D7A1F3-WP	542619	MSB4- $\frac{1}{4}$:C3J1M1D7A1F3-WP
	fully automatic	G $\frac{1}{4}$	542626	MSB4- $\frac{1}{4}$:C3J4M1D7A1F3-WP	542622	MSB4- $\frac{1}{4}$:C3J2M1D7A1F3-WP
MSB6	manual rotary	G $\frac{1}{2}$	542640	MSB6- $\frac{1}{2}$:C3J3M1D7A1F3-WP	542636	MSB6- $\frac{1}{2}$:C3J1M1D7A1F3-WP
	fully automatic	G $\frac{1}{2}$	542642	MSB6- $\frac{1}{2}$:C3J4M1D7A1F3-WP	542638	MSB6- $\frac{1}{2}$:C3J2M1D7A1F3-WP

Ordering data						
Pressure regulation range 4 ... 12 bar						
Size	Condensate drain	Connection	Grade of filtration 5 µm		Grade of filtration 40 µm	
			Part No.	Type	Part No.	Type
Plastic bowl guard						
MSB4	manual rotary	G $\frac{1}{4}$	542309	MSB4- $\frac{1}{4}$:C3J3M1D1A1F3-WP	542297	MSB4- $\frac{1}{4}$:C3J1M1D1A1F3-WP
	fully automatic	G $\frac{1}{4}$	542315	MSB4- $\frac{1}{4}$:C3J4M1D1A1F3-WP	542303	MSB4- $\frac{1}{4}$:C3J2M1D1A1F3-WP
MSB6	manual rotary	G $\frac{1}{2}$	542285	MSB6- $\frac{1}{2}$:C3J3M1D1A1F3-WP	542273	MSB6- $\frac{1}{2}$:C3J1M1D1A1F3-WP
	fully automatic	G $\frac{1}{2}$	542291	MSB6- $\frac{1}{2}$:C3J4M1D1A1F3-WP	542279	MSB6- $\frac{1}{2}$:C3J2M1D1A1F3-WP

Service unit combinations MSB4/MSB6, MS series

Technical data – Combination 4

Function

With condensate drain
manual rotary

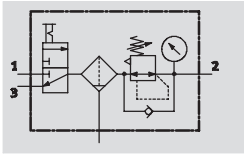

With condensate drain
fully automatic

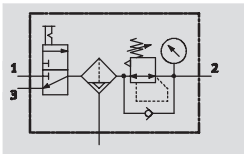

- - Flow rate
950 ... 5,100 l/min
- - Temperature range
-10 ... +60 °C
- - Pressure regulation
range
0.5 ... 12 bar



- On-off valve MS...-EM1
manually actuated
- Filter regulator MS...-LFR-D7
- Mounting bracket MS...-WP

- For filtered and unlubricated compressed air
- Supply pressure can be opened and closed
- Output pressure is infinitely adjustable within the pressure regulation range

General technical data		
Size	MSB4	MSB6
Pneumatic connection 1, 2, 3	G1/4	G1/2
Regulating function	With primary pressure compensation	
	With return flow function	
	With secondary venting	
	Output pressure constant	
Type of mounting	Via accessories	
Assembly position	Vertical ±5°	
Grade of filtration [µm]	5 (air purity class at the output 3.7.- to DIN ISO 8573-1)	
	40 (air purity class at the output 5.7.- to DIN ISO 8573-1)	
Bowl guard	Plastic bowl guard	
Condensate drain	Manual rotary	
	Fully automatic	
Actuator lock	Rotary knob with detent	
	Lockable with accessories	
Pressure regulation range [bar]	0.5 ... 12	
Pressure indicator	With pressure gauge	

• Note: This product conforms with the ISO 1179-1 standard and the ISO 228-1 standard.

Standard nominal flow rate qnN [l/min]		
Size	MSB4	MSB6
Grade of filtration	5 µm	950
	40 µm	1,000
		4,800
		5,100

Service unit combinations MSB4/MSB6, MS series

Technical data – Combination 4

Operating and environmental conditions				
Condensate drain	Manual rotary		Fully automatic	
Size	MSB4	MSB6	MSB4	MSB6
Supply pressure [bar]	0.8 ... 14	0.8 ... 18	1.5 ... 12	1.5 ... 12
Operating medium	Filtered compressed air, lubricated or unlubricated, grade of filtration 40 µm			
Ambient temperature [°C]	-10 ... +60		+5 ... +60	
Temperature of medium [°C]	-10 ... +60		+5 ... +60	
Storage temperature [°C]	-10 ... +60		-10 ... +60	
Corrosion resistance CRC ¹⁾	2			

1) Corrosion resistance class 2 according to Festo standard 940 070
 Components requiring moderate corrosion resistance. Externally visible parts with primarily decorative surface requirements which are in direct contact with a normal industrial environment or media such as coolants or lubricating agents.

Weights [g]		
Size	MSB4	MSB6
Service unit combination	1,300	1,100
Mounting bracket	40	76

 Note
 Materials → Technical data of the individual devices

Standard flow rate qn as a function of output pressure p2

Pressure regulation range 0.5 ... 12 bar Grade of filtration 5 µm Grade of filtration 40 µm
 MSB4-1/4

Primary pressure p1 = 10 bar

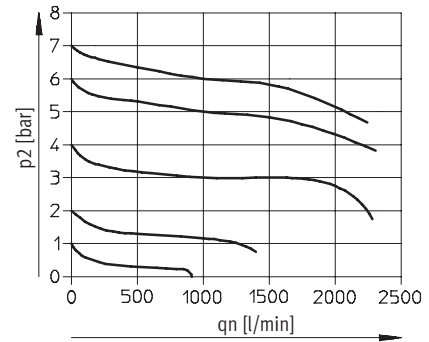
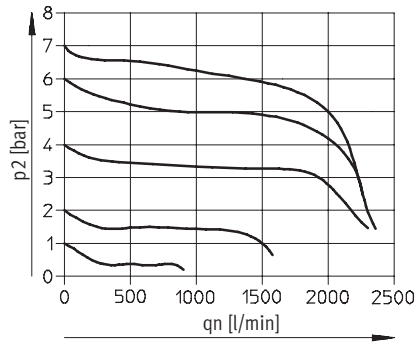

MSB6-1/2

Primary pressure p1 = 10 bar

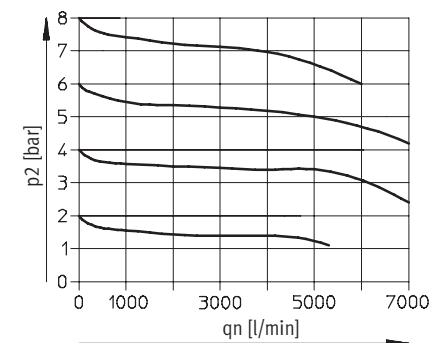
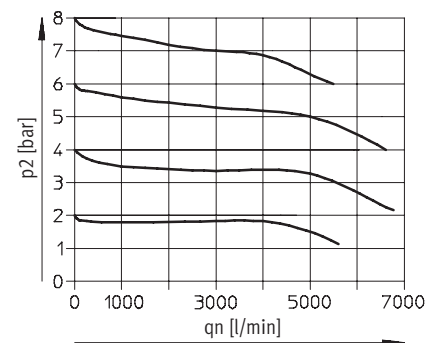

Service unit combinations MSB4/MSB6, MS series

Technical data – Combination 4

Dimensions Download CAD data → www.festo.com

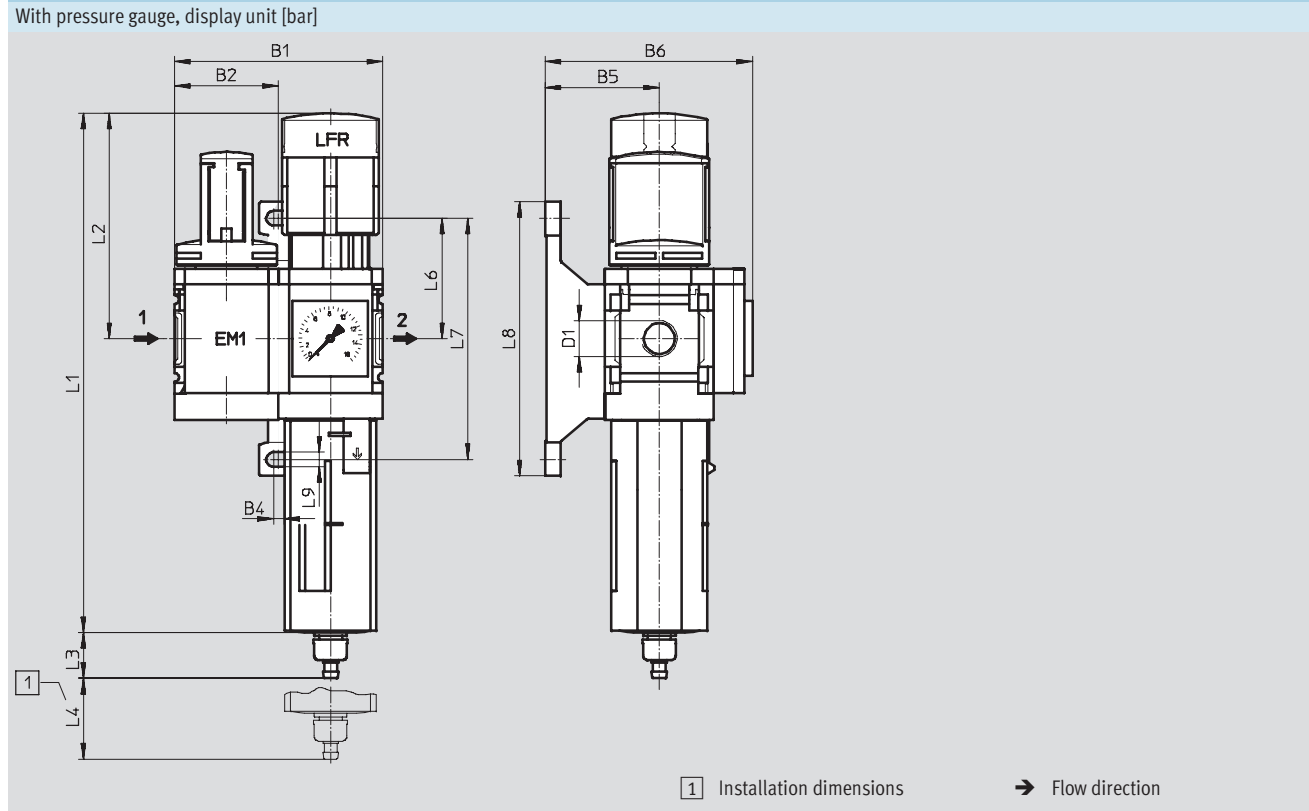

Type	B1	B2	B4	B5	B6	D1	L1	L2
MSB4	80.4	40.2	4	44	80	G $\frac{1}{4}$	201	87
MSB6	124	62	4.5	54	100	G $\frac{1}{2}$	285	134.5

Type	L3 Condensate drain		L4	L6	L7	L8	L9
	manual rotary	fully automatic					
MSB4	17.7	20.4	25	46.5	93.2	106	5.6
MSB6	15.8	18.5	68	71	142	158	6.6

• Note: This product conforms with the ISO 1179-1 standard and the ISO 228-1 standard.

Ordering data							
Pressure regulation range 0.5 ... 12 bar							
Size	Condensate drain	Connection	Grade of filtration 5 μ m		Grade of filtration 40 μ m		
			Part No.	Type	Part No.	Type	
Plastic bowl guard							
MSB4	manual rotary	G $\frac{1}{4}$	542304	MSB4- $\frac{1}{4}$:C3J3-WP	542292	MSB4- $\frac{1}{4}$:C3J1-WP	
	fully automatic	G $\frac{1}{4}$	542310	MSB4- $\frac{1}{4}$:C3J4-WP	542298	MSB4- $\frac{1}{4}$:C3J2-WP	
MSB6	manual rotary	G $\frac{1}{2}$	542280	MSB6- $\frac{1}{2}$:C3J3-WP	542268	MSB6- $\frac{1}{2}$:C3J1-WP	
	fully automatic	G $\frac{1}{2}$	542286	MSB6- $\frac{1}{2}$:C3J4-WP	542274	MSB6- $\frac{1}{2}$:C3J2-WP	

Service unit combinations MSB4/MSB6, MS series

Technical data – Combination 5

Function

With condensate drain
manual rotary

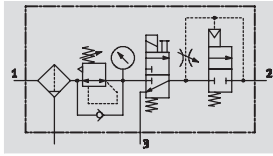

With condensate drain
fully automatic

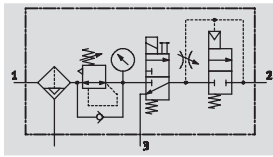

- Filter regulator MS...-LFR-D7
- On-off valve MS...-EE-10V24 or MS...-EE-V24 solenoid actuated
- Soft-start valve MS...-DL pneumatically actuated
- Mounting bracket MS...-WP

- Flow rate
700 ... 3,100 l/min
- Temperature range
-10 ... +60 °C
- Pressure regulation range
4 ... 12 bar



- For filtered and unlubricated compressed air
- Output pressure is infinitely adjustable within the pressure regulation range
- Gradual pressure build-up prevents sudden, unpredictable movements
- When supply pressure is closed, quick venting ensures rapid pressure reduction

General technical data		
Size	MSB4	MSB6
Pneumatic connection 1, 2, 3	G1/4	G1/2
Regulating function	With primary pressure compensation	
	With return flow function	
	With secondary venting	
	Output pressure constant	
Type of mounting	Via accessories	
Assembly position	Vertical ±5°	
Grade of filtration [µm]	5 (air purity class at the output 3.7.- to DIN ISO 8573-1)	
	40 (air purity class at the output 5.7.- to DIN ISO 8573-1)	
Bowl guard	Plastic bowl guard	
Condensate drain	Manual rotary	
	Fully automatic	
Actuator lock	Rotary knob with detent	
	Lockable with accessories	
Pressure regulation range [bar]	4 ... 9 (with on-off valve MS...-EE-10V24)	
	4 ... 12 (with on-off valve MS...-EE-V24)	
Pressure indicator	With pressure gauge	
Supply voltage [V DC]	24	

- | - Note: This product conforms with the ISO 1179-1 standard and the ISO 228-1 standard.

Standard nominal flow rate qnN [l/min]		
Size	MSB4	MSB6
Grade of filtration	5 µm	700
	40 µm	750
		3,000
		3,100

Service unit combinations MSB4/MSB6, MS series

Technical data – Combination 5

Operating and environmental conditions								
	Pressure regulation range 4 ... 9 bar				Pressure regulation range 4 ... 12 bar			
Condensate drain	Manual rotary		Fully automatic		Manual rotary		Fully automatic	
Size	MSB4	MSB6	MSB4	MSB6	MSB4	MSB6	MSB4	MSB6
Supply pressure [bar]	4.5 ... 10	4.5 ... 10	4.5 ... 10	4.5 ... 10	4.5 ... 14	4.5 ... 18	4.5 ... 12	4.5 ... 12
Operating medium	Filtered compressed air, lubricated or unlubricated, grade of filtration 40 µm							
Ambient temperature [°C]	-10 ... +50		+5 ... +50		-10 ... +60		+5 ... +60	
Temperature of medium [°C]	-10 ... +50		+5 ... +50		-10 ... +60		+5 ... +60	
Storage temperature [°C]	-10 ... +60		-10 ... +60		-10 ... +60		-10 ... +60	
Corrosion resistance CRC ¹⁾	2							

1) Corrosion resistance class 2 according to Festo standard 940 070
 Components requiring moderate corrosion resistance. Externally visible parts with primarily decorative surface requirements which are in direct contact with a normal industrial environment or media such as coolants or lubricating agents.

Weights [g]		
Size	MSB4	MSB6
Service unit combination	1,600	2,400
Mounting bracket	40	76

-  - Note
 Materials → Technical data of the individual devices

Standard flow rate qn as a function of output pressure p2

Pressure regulation range 4 ... 9 bar / 4 ... 12 bar
 MSB4-1/4

Primary pressure p1 = 10 bar

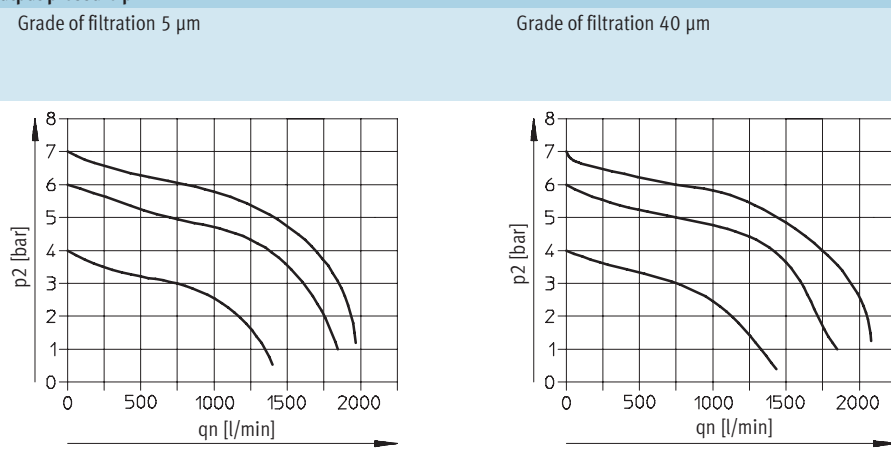

MSB6-1/2

Primary pressure p1 = 10 bar

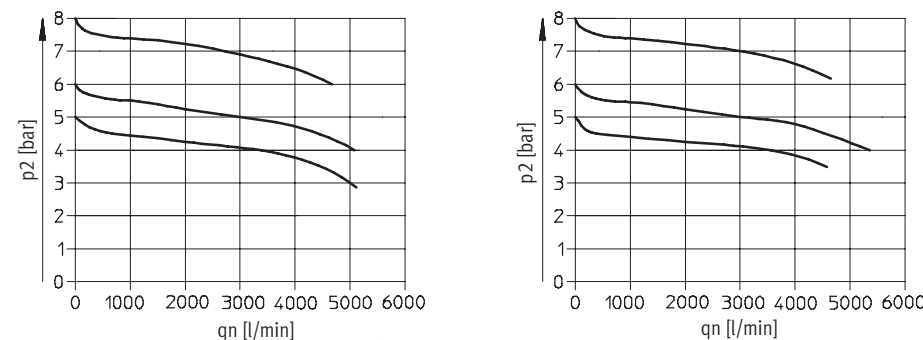

Service unit combinations MSB4/MSB6, MS series

Technical data – Combination 5

Dimensions

Download CAD data → www.festo.com

With pressure gauge, display unit [bar]

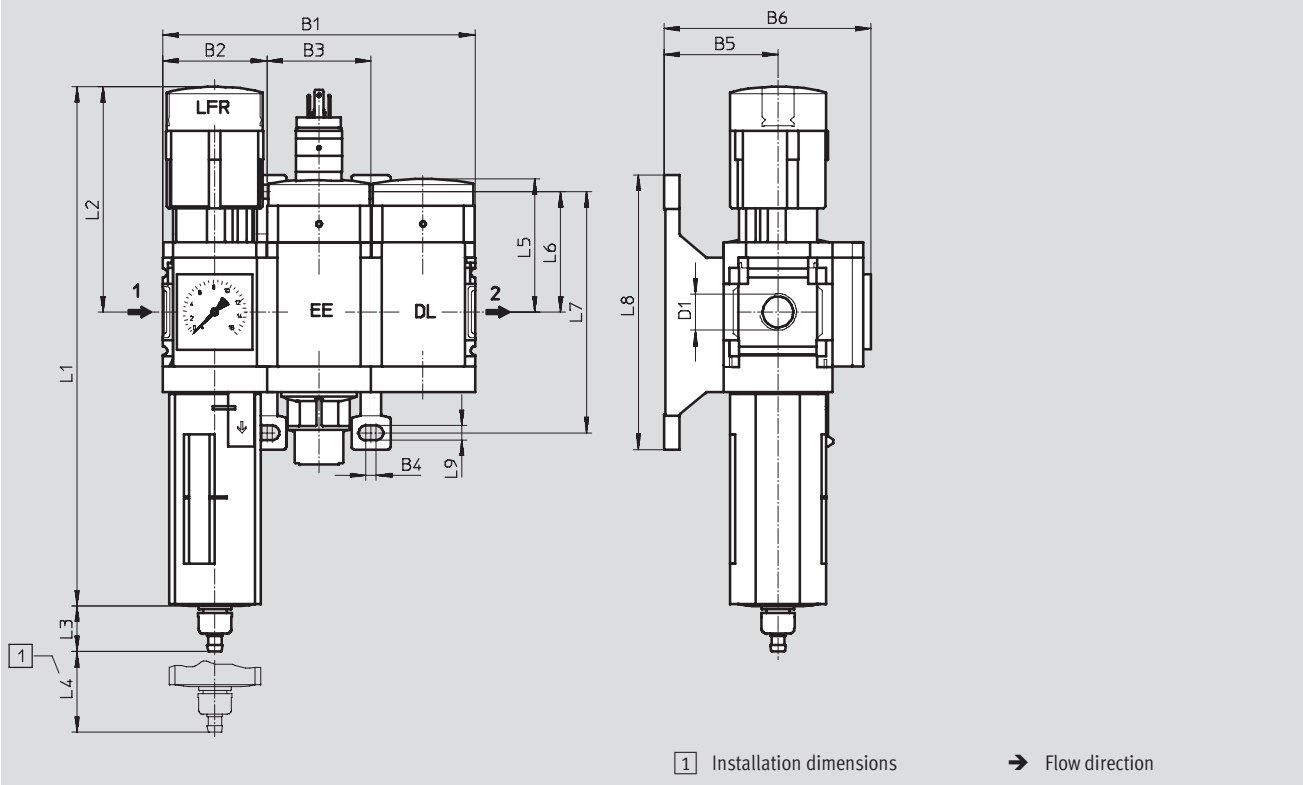

Type	B1	B2	B3	B4	B5	B6	D1	L1	L2
MSB4	120.6	40.2	40.2	4	44	80	G¼	201	87
MSB6	186	62	62	4.5	54	100	G½	285	134.5

Type	L3 Condensate drain		L4	L5	L6	L7	L8	L9
	manual rotary	fully automatic						
MSB4	17.7	20.4	25	51.7	46.5	93.2	106	5.6
MSB6	15.8	18.5	68	71	71	142	158	6.6

- | - Note: This product conforms with the ISO 1179-1 standard and the ISO 228-1 standard.

Service unit combinations MSB4/MSB6, MS series

FESTO

Technical data – Combination 5

Ordering data						
Pressure regulation range 4 ... 9 bar						
Size	Condensate drain	Connection	Grade of filtration 5 µm		Grade of filtration 40 µm	
			Part No.	Type	Part No.	Type
Plastic bowl guard						
MSB4	manual rotary	G $\frac{1}{4}$	542631	MSB4- $\frac{1}{4}$:J3D7A1-WP	542627	MSB4- $\frac{1}{4}$:J1D7A1-WP
	fully automatic	G $\frac{1}{4}$	542633	MSB4- $\frac{1}{4}$:J4D7A1-WP	542629	MSB4- $\frac{1}{4}$:J2D7A1-WP
MSB6	manual rotary	G $\frac{1}{2}$	542647	MSB6- $\frac{1}{2}$:J3D7A1-WP	542643	MSB6- $\frac{1}{2}$:J1D7A1-WP
	fully automatic	G $\frac{1}{2}$	542649	MSB6- $\frac{1}{2}$:J4D7A1-WP	542645	MSB6- $\frac{1}{2}$:J2D7A1-WP

Ordering data						
Pressure regulation range 4 ... 12 bar						
Size	Condensate drain	Connection	Grade of filtration 5 µm		Grade of filtration 40 µm	
			Part No.	Type	Part No.	Type
Plastic bowl guard						
MSB4	manual rotary	G $\frac{1}{4}$	531105	MSB4- $\frac{1}{4}$:J3D1A1-WP	531101	MSB4- $\frac{1}{4}$:J1D1A1-WP
	fully automatic	G $\frac{1}{4}$	531107	MSB4- $\frac{1}{4}$:J4D1A1-WP	531103	MSB4- $\frac{1}{4}$:J2D1A1-WP
MSB6	manual rotary	G $\frac{1}{2}$	530226	MSB6- $\frac{1}{2}$:J3D1A1-WP	530222	MSB6- $\frac{1}{2}$:J1D1A1-WP
	fully automatic	G $\frac{1}{2}$	530228	MSB6- $\frac{1}{2}$:J4D1A1-WP	530224	MSB6- $\frac{1}{2}$:J2D1A1-WP

Service unit combinations MSB4/MSB6, MS series

Technical data – Combination 6

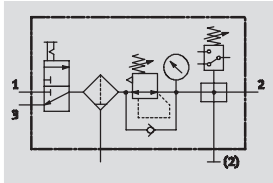

Function

With condensate drain
manual rotary

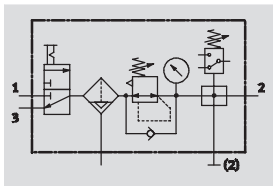

With condensate drain
fully automatic



-  Flow rate
1,250 ... 4,500 l/min
-  Temperature range
-10 ... +60 °C
-  Pressure regulation range
0.5 ... 12 bar



- For filtered and unlubricated compressed air
- Supply pressure can be opened and closed
- Output pressure is infinitely adjustable within the pressure regulation range
- Electrical pressure monitoring with adjustable switching pressure

- On-off valve MS...-EM1 manually actuated
- Filter regulator MS...-LFR-D7
- Branching module MS...-FRM-Y with pressure switch without display
- Mounting bracket MS...-WP

General technical data		
Size	MSB4	MSB6
Pneumatic connection 1, 2, 3	G1/4	G1/2
Regulating function	With primary pressure compensation	
	With return flow function	
	With secondary venting	
	Output pressure constant	
Type of mounting	Via accessories	
Assembly position	Vertical ±5°	
Grade of filtration [µm]	5 (air purity class at the output 3.7.- to DIN ISO 8573-1)	
	40 (air purity class at the output 5.7.- to DIN ISO 8573-1)	
Bowl guard	Plastic bowl guard	
Condensate drain	Manual rotary	
	Fully automatic	
Actuator lock	Rotary knob with detent	
	Lockable with accessories	
Pressure regulation range [bar]	0.5 ... 12	
Pressure indicator	With pressure gauge	

- || - Note: This product conforms with the ISO 1179-1 standard and the ISO 228-1 standard.

Standard nominal flow rate qnN [l/min]			
Size	MSB4	MSB6	
Grade of filtration	5 µm	1,250	4,400
	40 µm	1,300	4,500

Service unit combinations MSB4/MSB6, MS series

Technical data – Combination 6

Operating and environmental conditions				
Condensate drain		Manual rotary		Fully automatic
Size	MSB4	MSB6	MSB4	MSB6
Supply pressure [bar]	0.8 ... 14	0.8 ... 18	1.5 ... 12	1.5 ... 12
Operating medium	Filtered compressed air, lubricated or unlubricated, grade of filtration 40 µm			
Ambient temperature [°C]	-10 ... +60		+5 ... +60	
Temperature of medium [°C]	-10 ... +60		+5 ... +60	
Storage temperature [°C]	-10 ... +60		-10 ... +60	
Corrosion resistance CRC ¹⁾	2			

1) Corrosion resistance class 2 according to Festo standard 940 070
 Components requiring moderate corrosion resistance. Externally visible parts with primarily decorative surface requirements which are in direct contact with a normal industrial environment or media such as coolants or lubricating agents.

Weights [g]		
Size	MSB4	MSB6
Service unit combination	1,500	2,000
Mounting bracket	40	76

-  - Note
 Materials → Technical data of the individual devices

Standard flow rate qn as a function of output pressure p2

Pressure regulation range 0.5 ... 12 bar Grade of filtration 5 µm Grade of filtration 40 µm
 MSB4-1/4

Primary pressure p1 = 10 bar

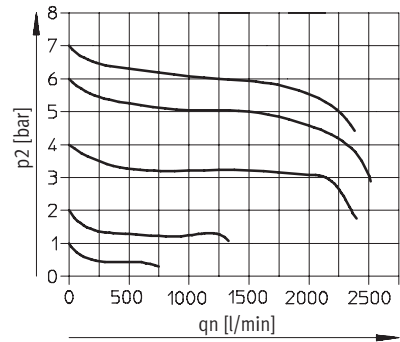
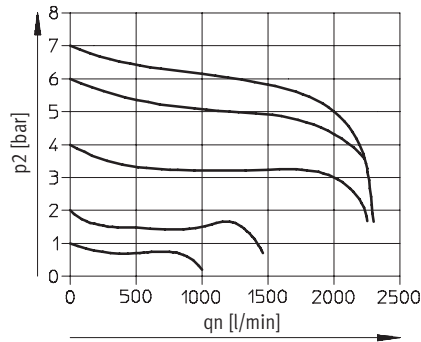

MSB6-1/2

Primary pressure p1 = 10 bar

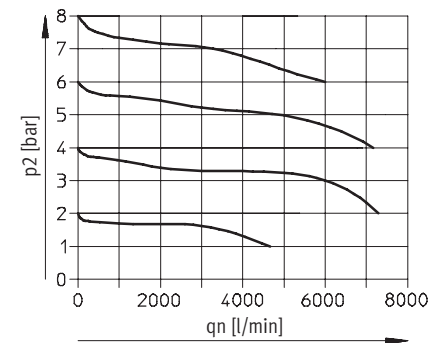
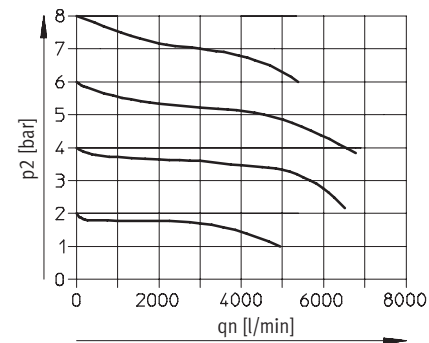

Service unit combinations MSB4/MSB6, MS series

Technical data – Combination 6

Dimensions

Download CAD data → www.festo.com

With pressure gauge, display unit [bar]

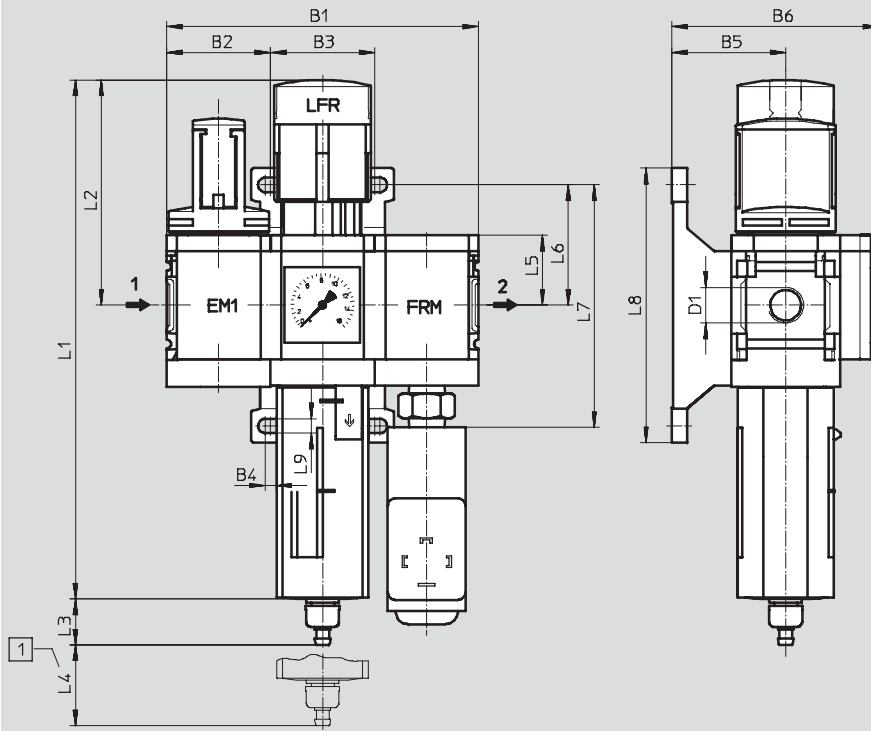

1 Installation dimensions

→ Flow direction

Type	B1	B2	B3	B4	B5	B6	D1	L1	L2
MSB4	120.6	40.2	40.2	4	44	80	G $\frac{1}{4}$	201	87
MSB6	186	62	62	4.5	54	100	G $\frac{1}{2}$	285	134.5

Type	L3 Condensate drain		L4	L5	L6	L7	L8	L9
	manual rotary	fully automatic						
MSB4	17.7	20.4	25	27	46.5	93.2	106	5.6
MSB6	15.8	18.5	68	39	71	142	158	6.6

• Note: This product conforms with the ISO 1179-1 standard and the ISO 228-1 standard.

Ordering data

Pressure regulation range 0.5 ... 12 bar

Size	Condensate drain	Connection	Grade of filtration 5 μ m		Grade of filtration 40 μ m	
			Part No.	Type	Part No.	Type
Plastic bowl guard						
MSB4	manual rotary	G $\frac{1}{4}$	542306	MSB4- $\frac{1}{4}$:C3J3F3-WP	542294	MSB4- $\frac{1}{4}$:C3J1F3-WP
	fully automatic	G $\frac{1}{4}$	542312	MSB4- $\frac{1}{4}$:C3J4F3-WP	542300	MSB4- $\frac{1}{4}$:C3J2F3-WP
MSB6	manual rotary	G $\frac{1}{2}$	542282	MSB6- $\frac{1}{2}$:C3J3F3-WP	542270	MSB6- $\frac{1}{2}$:C3J1F3-WP
	fully automatic	G $\frac{1}{2}$	542288	MSB6- $\frac{1}{2}$:C3J4F3-WP	542276	MSB6- $\frac{1}{2}$:C3J2F3-WP

Service unit combinations MSB4/MSB6, MS series

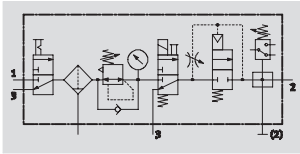

Technical data – Combination 7

Function
With condensate drain
manual rotary

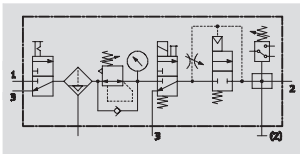

With condensate drain
fully automatic



-  Flow rate
700 ... 3,100 l/min
-  Temperature range
-10 ... +60 °C
-  Pressure regulation range
4 ... 12 bar



- On-off valve MS...-EM1
manually actuated
- Filter regulator MS...-LFR-D7
- On-off valve MS...-EE-10V24 or MS...-EE-V24
solenoid actuated
- Soft-start valve MS...-DL
pneumatically actuated
- Branching module MS...-FRM-Y
with pressure switch without display
- Mounting bracket MS...-WP

- For filtered and unlubricated compressed air
- Supply pressure can be opened and closed
- Output pressure is infinitely adjustable within the pressure regulation range
- Gradual pressure build-up prevents sudden, unpredictable movements
- To shut-off and vent the following device or the system
- Electrical pressure monitoring with adjustable switching pressure

General technical data		
Size	MSB4	MSB6
Pneumatic connection 1, 2, 3	G1/4	G1/2
Regulating function	With primary pressure compensation	
	With return flow function	
	With secondary venting	
	Output pressure constant	
Type of mounting	Via accessories	
Assembly position	Vertical ±5°	
Grade of filtration [µm]	5 (air purity class at the output 3.7.- to DIN ISO 8573-1)	
	40 (air purity class at the output 5.7.- to DIN ISO 8573-1)	
Bowl guard	Plastic bowl guard	
Condensate drain	Manual rotary	
	Fully automatic	
Actuator lock	Rotary knob with detent	
	Lockable with accessories	
Pressure regulation range [bar]	4 ... 9 (with on-off valve MS...-EE-10V24)	
	4 ... 12 (with on-off valve MS...-EE-V24)	
Pressure indicator	With pressure gauge	
Supply voltage [V DC]	24	

- || - Note: This product conforms with the ISO 1179-1 standard and the ISO 228-1 standard.

Standard nominal flow rate qnN [l/min]		
Size	MSB4	MSB6
Grade of filtration	5 µm	700
	40 µm	750
		3,000
		3,100

Service unit combinations MSB4/MSB6, MS series

Technical data – Combination 7

Operating and environmental conditions								
	Pressure regulation range 4 ... 9 bar				Pressure regulation range 4 ... 12 bar			
Condensate drain	Manual rotary		Fully automatic		Manual rotary		Fully automatic	
Size	MSB4	MSB6	MSB4	MSB6	MSB4	MSB6	MSB4	MSB6
Supply pressure [bar]	4.5 ... 10	4.5 ... 10	4.5 ... 10	4.5 ... 10	4.5 ... 14	4.5 ... 18	4.5 ... 12	4.5 ... 12
Operating medium	Filtered compressed air, lubricated or unlubricated, grade of filtration 40 µm							
Ambient temperature [°C]	-10 ... +50		+5 ... +50		-10 ... +60		+5 ... +60	
Temperature of medium [°C]	-10 ... +50		+5 ... +50		-10 ... +60		+5 ... +60	
Storage temperature [°C]	-10 ... +60		-10 ... +60		-10 ... +60		-10 ... +60	
Corrosion resistance CRC ¹⁾	2							

1) Corrosion resistance class 2 according to Festo standard 940 070
 Components requiring moderate corrosion resistance. Externally visible parts with primarily decorative surface requirements which are in direct contact with a normal industrial environment or media such as coolants or lubricating agents.

Weights [g]		
Size	MSB4	MSB6
Service unit combination	2,200	3,500
Mounting bracket	40	76

 - Note
 Materials → Technical data of the individual devices

Standard flow rate qn as a function of output pressure p2

Pressure regulation range 4 ... 9 bar / 4 ... 12 bar
 MSB4-1/4

Primary pressure p1 = 10 bar

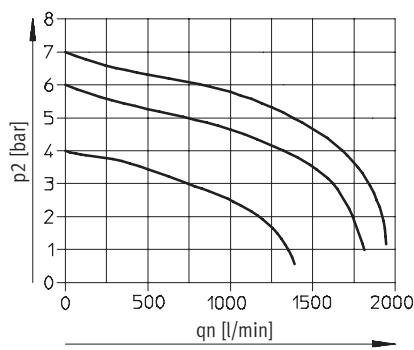

Grade of filtration 40 µm

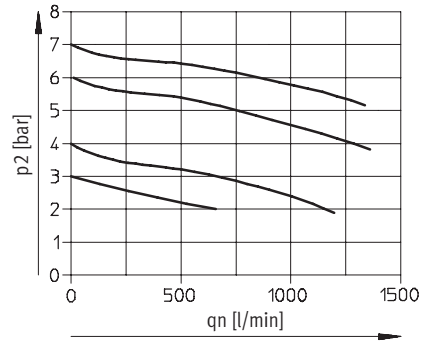

MSB6-1/2

Primary pressure p1 = 10 bar

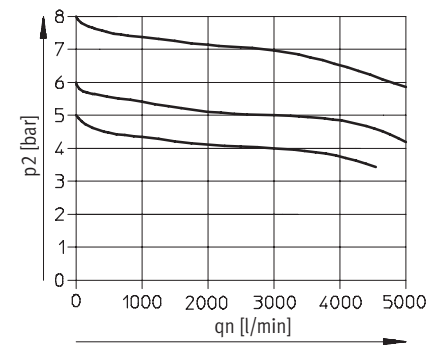
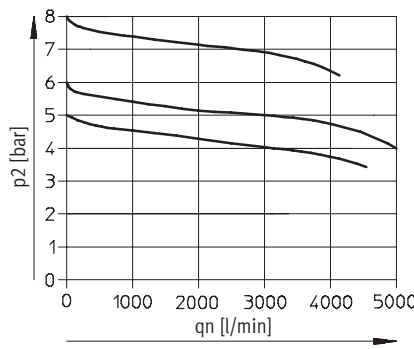

Service unit combinations MSB4/MSB6, MS series

Technical data – Combination 7

Dimensions

Download CAD data → www.festo.com

With pressure gauge, display unit [bar]

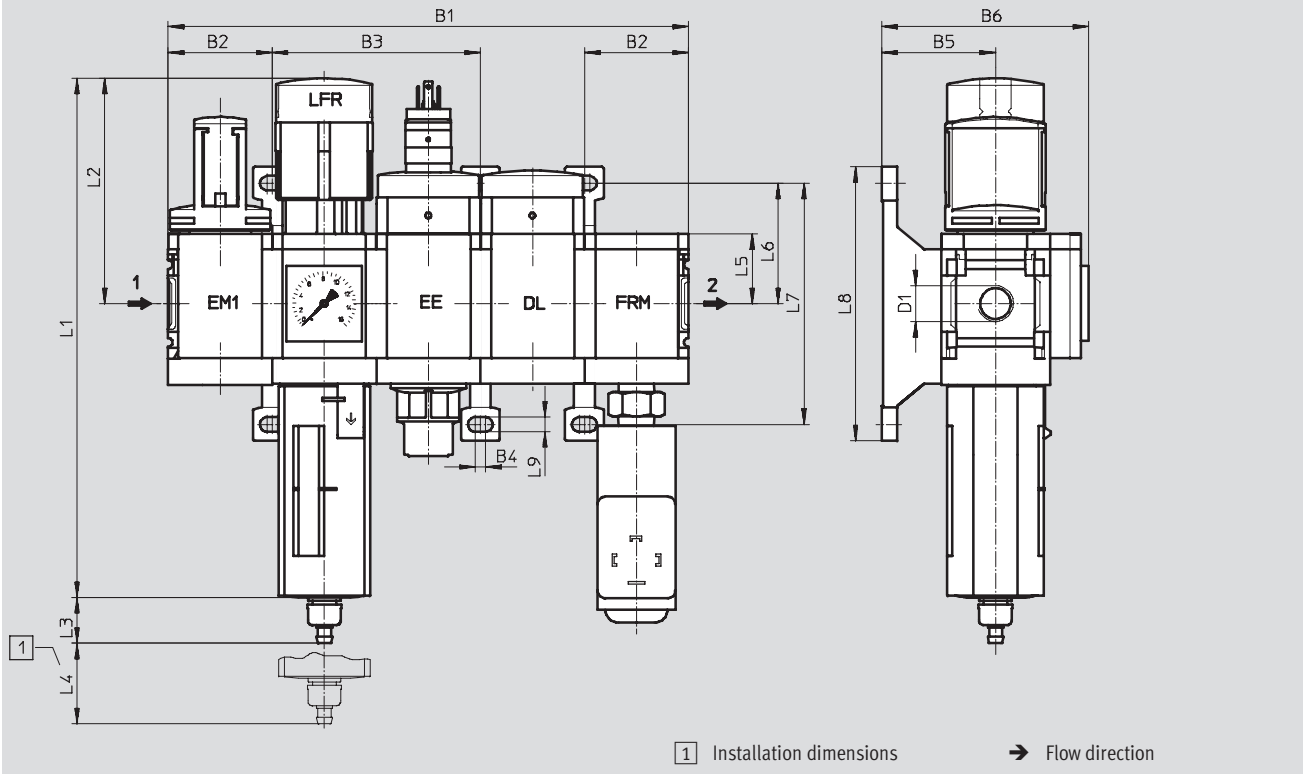

Type	B1	B2	B3	B4	B5	B6	D1	L1	L2
MSB4	201	40.2	80.4	4	44	80	G $\frac{1}{4}$	201	87
MSB6	310	62	124	4.5	54	100	G $\frac{1}{2}$	285	134.5

Type	L3 Condensate drain		L4	L5	L6	L7	L8	L9
	manual rotary	fully automatic						
MSB4	17.7	20.4	25	27	46.5	93.2	106	5.6
MSB6	15.8	18.5	68	39	71	142	158	6.6

• • Note: This product conforms with the ISO 1179-1 standard and the ISO 228-1 standard.

Service unit combinations MSB4/MSB6, MS series

FESTO

Technical data – Combination 7

Ordering data						
Pressure regulation range 4 ... 9 bar						
Size	Condensate drain	Connection	Grade of filtration 5 µm		Grade of filtration 40 µm	
			Part No.	Type	Part No.	Type
Plastic bowl guard						
MSB4	manual rotary	G $\frac{1}{4}$	542623	MSB4- $\frac{1}{4}$:C3J3D7A1F3-WP	542618	MSB4- $\frac{1}{4}$:C3J1D7A1F3-WP
	fully automatic	G $\frac{1}{4}$	542625	MSB4- $\frac{1}{4}$:C3J4D7A1F3-WP	542621	MSB4- $\frac{1}{4}$:C3J2D7A1F3-WP
MSB6	manual rotary	G $\frac{1}{2}$	542639	MSB6- $\frac{1}{2}$:C3J3D7A1F3-WP	542635	MSB6- $\frac{1}{2}$:C3J1D7A1F3-WP
	fully automatic	G $\frac{1}{2}$	542641	MSB6- $\frac{1}{2}$:C3J4D7A1F3-WP	542637	MSB6- $\frac{1}{2}$:C3J2D7A1F3-WP

Ordering data						
Pressure regulation range 4 ... 12 bar						
Size	Condensate drain	Connection	Grade of filtration 5 µm		Grade of filtration 40 µm	
			Part No.	Type	Part No.	Type
Plastic bowl guard						
MSB4	manual rotary	G $\frac{1}{4}$	542305	MSB4- $\frac{1}{4}$:C3J3D1A1F3-WP	542293	MSB4- $\frac{1}{4}$:C3J1D1A1F3-WP
	fully automatic	G $\frac{1}{4}$	542311	MSB4- $\frac{1}{4}$:C3J4D1A1F3-WP	542299	MSB4- $\frac{1}{4}$:C3J2D1A1F3-WP
MSB6	manual rotary	G $\frac{1}{2}$	542281	MSB6- $\frac{1}{2}$:C3J3D1A1F3-WP	542269	MSB6- $\frac{1}{2}$:C3J1D1A1F3-WP
	fully automatic	G $\frac{1}{2}$	542287	MSB6- $\frac{1}{2}$:C3J4D1A1F3-WP	542275	MSB6- $\frac{1}{2}$:C3J2D1A1F3-WP

Service unit combinations MSB4/MSB6, MS series

Technical data – Combination 8

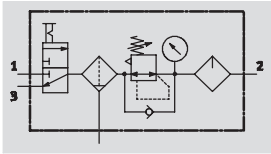

Function

With condensate drain
manual rotary

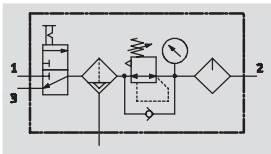

With condensate drain
fully automatic



-  Flow rate
700 ... 3,100 l/min
-  Temperature range
-10 ... +60 °C
-  Pressure regulation
range
1 ... 12 bar



- On-off valve MS...-EM1
manually actuated
- Filter regulator MS...-LFR-D7
- Lubricator MS...-LOE-R
- Mounting bracket MS...-WP

- For filtered and lubricated compressed air
- Supply pressure can be opened and closed
- Output pressure is infinitely adjustable within the pressure regulation range

General technical data		
Size	MSB4	MSB6
Pneumatic connection 1, 2, 3	G1/4	G1/2
Regulating function	With primary pressure compensation	
	With return flow function	
	With secondary venting	
	Output pressure constant	
Type of mounting	Via accessories	
Assembly position	Vertical ±5°	
Grade of filtration [µm]	5 (air purity class at the output 3.7.- to DIN ISO 8573-1)	
	40 (air purity class at the output 5.7.- to DIN ISO 8573-1)	
Bowl guard	Plastic bowl guard	
Condensate drain	Manual rotary	
	Fully automatic	
Actuator lock	Rotary knob with detent	
	Lockable with accessories	
Pressure regulation range [bar]	1 ... 12	
Pressure indicator	With pressure gauge	

- | - Note: This product conforms with the ISO 1179-1 standard and the ISO 228-1 standard.

Standard nominal flow rate qnN [l/min]			
Size		MSB4	MSB6
Grade of filtration	5 µm	700	3,000
	40 µm	750	3,100

Service unit combinations MSB4/MSB6, MS series

Technical data – Combination 8

Operating and environmental conditions				
Condensate drain	Manual rotary		Fully automatic	
Size	MSB4	MSB6	MSB4	MSB6
Supply pressure [bar]	1.5 ... 14	1.5 ... 18	1.5 ... 12	1.5 ... 12
Operating medium	Filtered compressed air, lubricated or unlubricated, grade of filtration 40 µm			
Ambient temperature [°C]	-10 ... +60		+5 ... +60	
Temperature of medium [°C]	-10 ... +60		+5 ... +60	
Storage temperature [°C]	-10 ... +60		-10 ... +60	
Corrosion resistance CRC ¹⁾	2			

1) Corrosion resistance class 2 according to Festo standard 940 070
 Components requiring moderate corrosion resistance. Externally visible parts with primarily decorative surface requirements which are in direct contact with a normal industrial environment or media such as coolants or lubricating agents.

Weights [g]		
Size	MSB4	MSB6
Service unit combination	1,500	1,750
Mounting bracket	40	76

 Note
 Materials → Technical data of the individual devices

Standard flow rate qn as a function of output pressure p2

Pressure regulation range 1 ... 12 bar Grade of filtration 5 µm Grade of filtration 40 µm
 MSB4-1/4

Primary pressure p1 = 10 bar

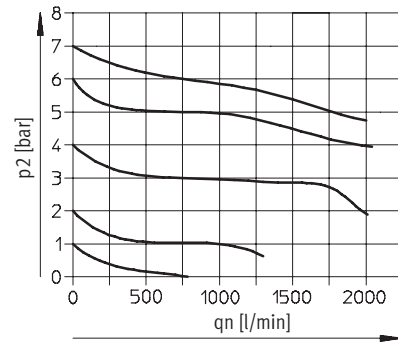
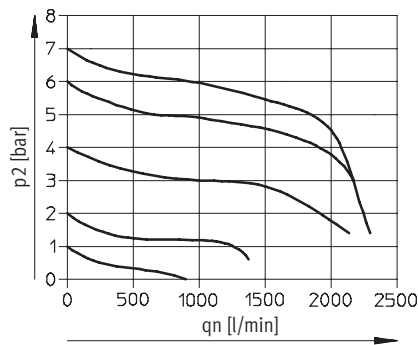

MSB6-1/2

Primary pressure p1 = 10 bar

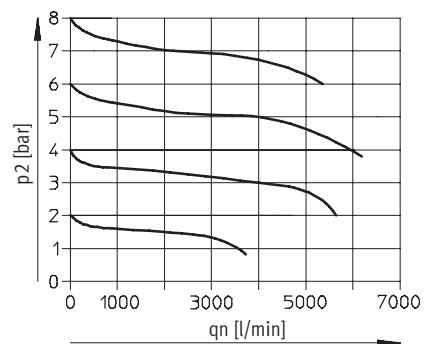
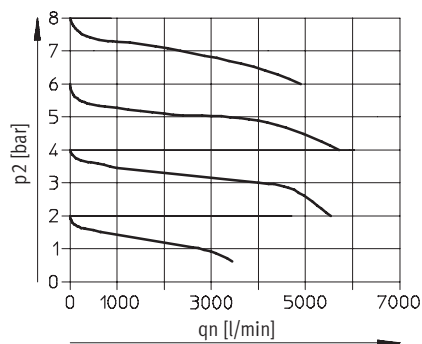

Service unit combinations MSB4/MSB6, MS series

Technical data – Combination 8

Dimensions Download CAD data → www.festo.com

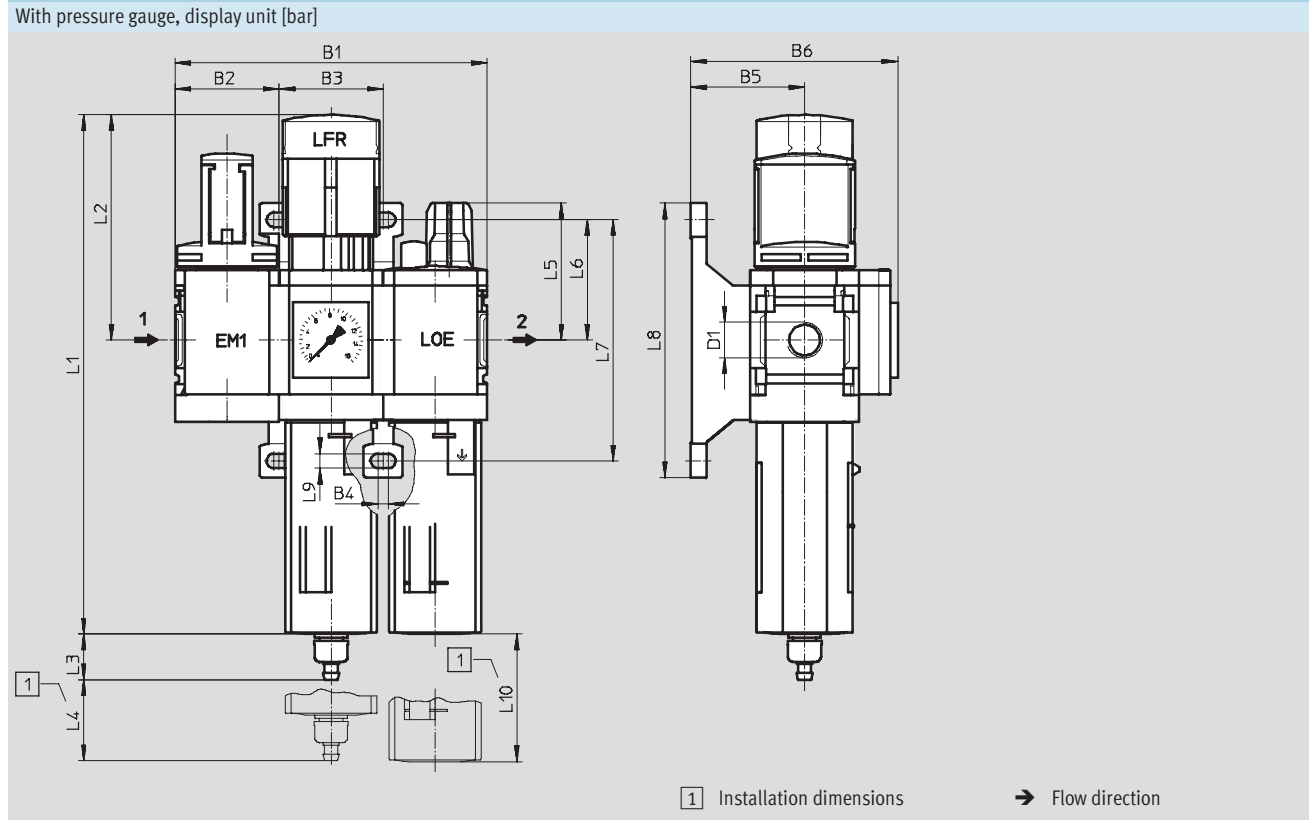

Type	B1	B2	B3	B4	B5	B6	D1	L1	L2
MSB4	120.6	40.2	40.2	4	44	80	G $\frac{1}{4}$	201	87
MSB6	186	62	62	4.5	54	100	G $\frac{1}{2}$	285	134.5

Type	L3 Condensate drain		L4	L5	L6	L7	L8	L9	L10
	manual rotary	fully automatic							
MSB4	17.7	20.4	25	53	46.5	93.2	106	5.6	80
MSB6	15.8	18.5	68	66	71	142	158	6.6	130

Note: This product conforms with the ISO 1179-1 standard and the ISO 228-1 standard.

Ordering data									
Pressure regulation range 1 ... 12 bar									
Size	Condensate drain	Connection	Grade of filtration 5 μ m				Grade of filtration 40 μ m		
			Part No.	Type	Part No.	Type	Part No.	Type	
Plastic bowl guard									
MSB4	manual rotary	G $\frac{1}{4}$	542308	MSB4- $\frac{1}{4}$:C3J3M1-WP	542296	MSB4- $\frac{1}{4}$:C3J1M1-WP			
	fully automatic	G $\frac{1}{4}$	542314	MSB4- $\frac{1}{4}$:C3J4M1-WP	542302	MSB4- $\frac{1}{4}$:C3J2M1-WP			
MSB6	manual rotary	G $\frac{1}{2}$	542284	MSB6- $\frac{1}{2}$:C3J3M1-WP	542272	MSB6- $\frac{1}{2}$:C3J1M1-WP			
	fully automatic	G $\frac{1}{2}$	542290	MSB6- $\frac{1}{2}$:C3J4M1-WP	542278	MSB6- $\frac{1}{2}$:C3J2M1-WP			

Service unit combinations MSB4/MSB6, MS series

Technical data – Combination 9

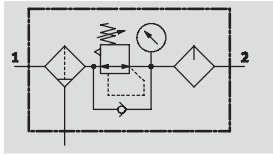

Function

With condensate drain
manual rotary

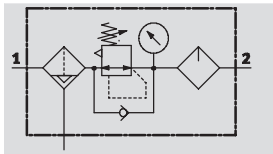

With condensate drain
fully automatic



-  Flow rate
700 ... 4,700 l/min
-  Temperature range
-10 ... +60 °C
-  Pressure regulation range
1 ... 12 bar



- For filtered and lubricated compressed air
- Output pressure is infinitely adjustable within the pressure regulation range

- Filter MS...-LF
- Pressure regulator MS...-LR
- Lubricator MS...-LOE
- Mounting bracket MS...-WP

General technical data		
Size	MSB4	MSB6
Pneumatic connection 1, 2	G1/4	G1/2
Type of mounting	Via accessories	
Assembly position	Vertical ±5°	
Grade of filtration [µm]	5 (air purity class at the output 3.7.- to DIN ISO 8573-1)	
	40 (air purity class at the output 5.7.- to DIN ISO 8573-1)	
Bowl guard	Plastic bowl guard	
	Metal bowl guard	
Condensate drain	Manual rotary	
	Fully automatic	
Actuator lock	Rotary knob with detent	
	Lockable with accessories	
Pressure regulation range	N2 [bar]	1 ... 7
	N3 [bar]	1 ... 12
Pressure indicator	With pressure gauge	

• † - Note: This product conforms with the ISO 1179-1 standard and the ISO 228-1 standard.

Standard nominal flow rate qnN [l/min]			
Size	MSB4		MSB6
N2 – Pressure regulation range 1 ... 7 bar			
Grade of filtration	40 µm	1,300	4,700
N3 – Pressure regulation range 1 ... 12 bar			
Grade of filtration	5 µm	700	3,500
	40 µm	800	3,500

Service unit combinations MSB4/MSB6, MS series

Technical data – Combination 9

Operating and environmental conditions				
Condensate drain	Manual rotary		Fully automatic	
Size	MSB4	MSB6	MSB4	MSB6
Supply pressure [bar]	1.5 ... 14	1.5 ... 18	1.5 ... 12	1.5 ... 12
Operating medium	Filtered compressed air, lubricated or unlubricated, grade of filtration 40 µm			
Ambient temperature [°C]	-10 ... +60		+5 ... +60	
Temperature of medium [°C]	-10 ... +60		+5 ... +60	
Storage temperature [°C]	-10 ... +60		-10 ... +60	
Corrosion resistance CRC ¹⁾	2			

1) Corrosion resistance class 2 according to Festo standard 940 070
 Components requiring moderate corrosion resistance. Externally visible parts with primarily decorative surface requirements which are in direct contact with a normal industrial environment or media such as coolants or lubricating agents.

Weights [g]		
Size	MSB4	MSB6
Service unit combination		
With plastic bowl guard	1,000	2,000
With metal bowl guard	-	2,400
Mounting bracket		
	40	76

-  - Note
 Materials → Technical data of the individual devices

Standard flow rate qn as a function of output pressure p2

Pressure regulation range N2 or N3 MSB4-1/4 Grade of filtration 5 µm Grade of filtration 40 µm

Primary pressure p1 = 10 bar

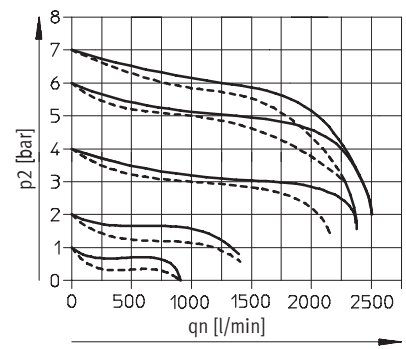
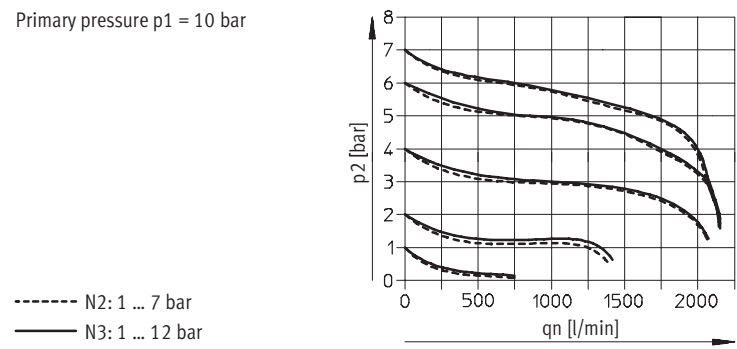

MSB6-1/2

Primary pressure p1 = 10 bar

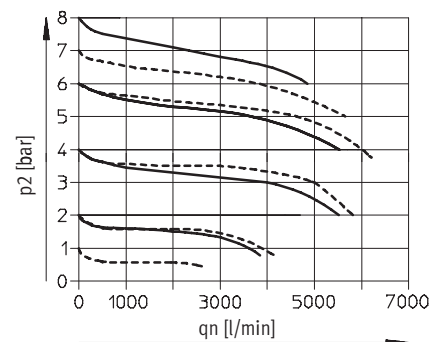
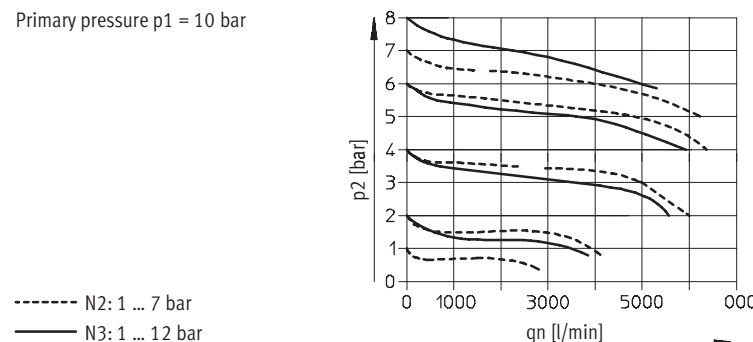

Service unit combinations MSB4/MSB6, MS series

Technical data – Combination 9

Dimensions

Download CAD data → www.festo.com

With pressure gauge, display unit [bar]

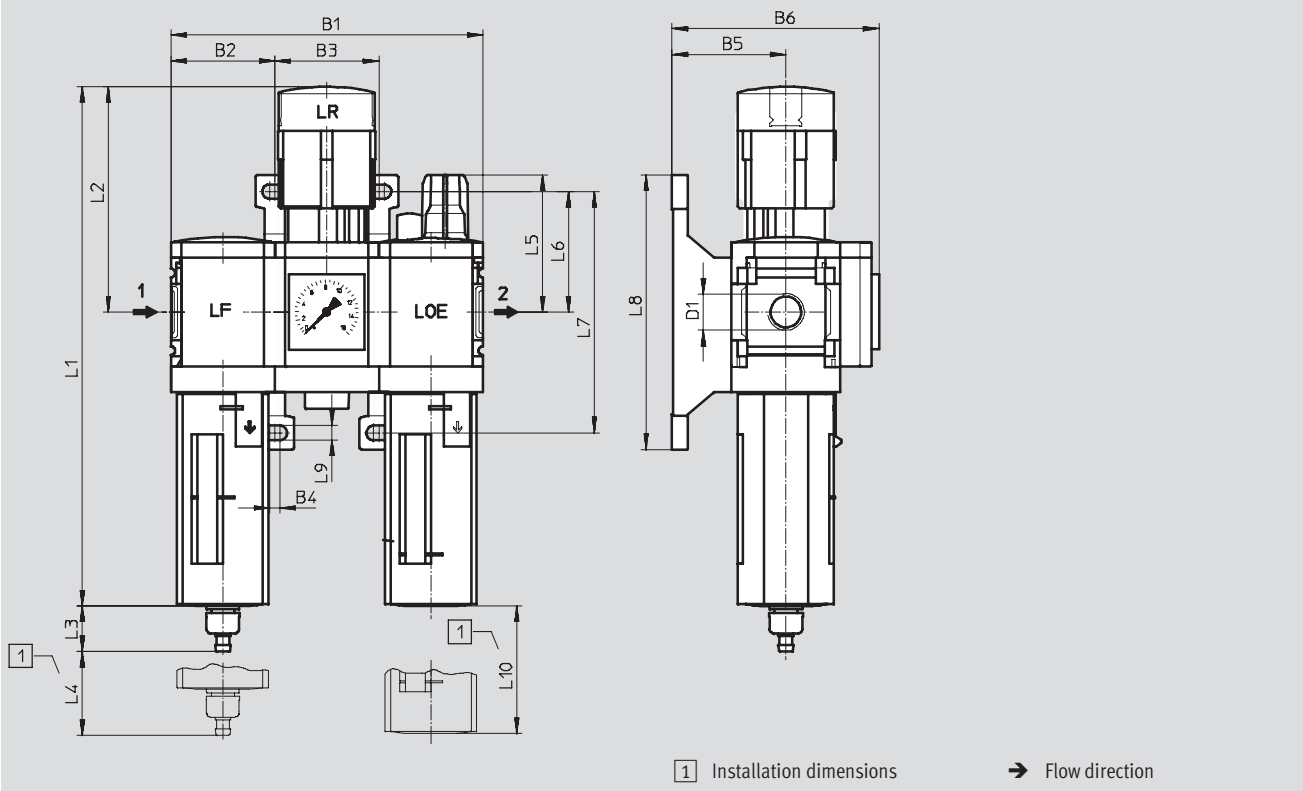

Type	B1	B2	B3	B4	B5	B6	D1	L1	L2
MSB4	120.6	40.2	40.2	4	44	80	G $\frac{1}{4}$	201	87
MSB6	186	62	62	4.5	54	100	G $\frac{1}{2}$	285	134.5

Type	L3 Condensate drain		L4	L5	L6	L7	L8	L9	L10
	manual rotary	fully auto-matic							
MSB4	17.7	20.4	25	53	46.5	93.2	106	5.6	80
MSB6	15.8	18.5	68	66	71	142	158	6.6	130

– † – Note: This product conforms with the ISO 1179-1 standard and the ISO 228-1 standard.

Service unit combinations MSB4/MSB6, MS series

FESTO

Technical data – Combination 9

Ordering data				
Pressure regulation range 1 ... 7 bar				
Size	Condensate drain	Connection	Grade of filtration 40 µm	
			Part No.	Type
Plastic bowl guard				
MSB4	manual rotary	G $\frac{1}{4}$	531091	MSB4- $\frac{1}{4}$:H2N2M1-WP
	fully automatic	G $\frac{1}{4}$	531085	MSB4- $\frac{1}{4}$:H1N2M1-WP
MSB6	manual rotary	G $\frac{1}{2}$	530212	MSB6- $\frac{1}{2}$:H2N2M1-WP
	fully automatic	G $\frac{1}{2}$	530206	MSB6- $\frac{1}{2}$:H1N2M1-WP

Ordering data						
Pressure regulation range 1 ... 12 bar						
Size	Condensate drain	Connection	Grade of filtration 5 µm		Grade of filtration 40 µm	
			Part No.	Type	Part No.	Type
Plastic bowl guard						
MSB4	manual rotary	G $\frac{1}{4}$	531097	MSB4- $\frac{1}{4}$:H3N3M1-WP	531093	MSB4- $\frac{1}{4}$:H2N3M1-WP
	fully automatic	G $\frac{1}{4}$	531099	MSB4- $\frac{1}{4}$:H4N3M1-WP	531087	MSB4- $\frac{1}{4}$:H1N3M1-WP
MSB6	manual rotary	G $\frac{1}{2}$	530218	MSB6- $\frac{1}{2}$:H3N3M1-WP	530214	MSB6- $\frac{1}{2}$:H2N3M1-WP
	fully automatic	G $\frac{1}{2}$	530220	MSB6- $\frac{1}{2}$:H4N3M1-WP	530208	MSB6- $\frac{1}{2}$:H1N3M1-WP
Metal bowl guard						
MSB4	manual rotary	G $\frac{1}{4}$	-	-	531095	MSB4- $\frac{1}{4}$:H8N3M2-WP
	fully automatic	G $\frac{1}{4}$	-	-	531089	MSB4- $\frac{1}{4}$:H7N3M2-WP
MSB6	manual rotary	G $\frac{1}{2}$	-	-	530216	MSB6- $\frac{1}{2}$:H8N3M2-WP
	fully automatic	G $\frac{1}{2}$	-	-	530210	MSB6- $\frac{1}{2}$:H7N3M2-WP

Service unit combinations MSB, MS series

FESTO

Accessories

Ordering data – Silencer U				Technical data → Internet: u	
	Description	Pneumatic connection	Part No.	Type	
	for MS4-EM1/EE	G $\frac{1}{4}$	6842	U- $\frac{1}{4}$ -B	
	for MS6-EM1/EE	G $\frac{1}{2}$	6844	U- $\frac{1}{2}$ -B	

Ordering data – Angled socket PEV					Technical data → Internet: pev	
	Description	Operating voltage range	Electrical connection	Switching status display	Part No.	Type
	for PEV- $\frac{1}{4}$ -...-OD	15 ... 30 V DC	4-pin	Yellow LED	164274	PEV- $\frac{1}{4}$ -WD-LED-24
		≤ 230 V AC	4-pin	Yellow LED	164275	PEV- $\frac{1}{4}$ -WD-LED-230
		≤ 180 V DC				

Ordering data – Plug socket MSSD					Technical data → Internet: mssd	
	Description	Operating voltage range	Electrical connection	Type of mounting cable connection	Part No.	Type
	for PEV- $\frac{1}{4}$ -...-OD	≤ 250 V AC/DC	3-pin	Clamping screws	171157	MSSD-C-4P
	for MS4/6-EE/DE	≤ 250 V AC/DC	3-pin	Clamping screws	151687	MSSD-EB
			4-pin	Insulation displacement technology	192745	MSSD-EB-S-M14

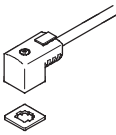
Ordering data – Plug socket with cable KMEB						Technical data → Internet: kmeb	
	Description	Operating voltage range	Electrical connection	Switching status display	Cable length [m]	Part No.	Type
	for MS4/6-EE/DE	24 V DC	2-pin	LED	2.5	547268	KMEB-3-24-2,5-LED
					5	547269	KMEB-3-24-5-LED
					2.5	547270	KMEB-3-24-2,5
			5	547271	KMEB-3-24-5		
			3-pin	LED	2.5	151688	KMEB-1-24-2,5-LED
					5	151689	KMEB-1-24-5-LED
		10			193457	KMEB-1-24-10-LED	
		230 V AC	3-pin	-	2.5	151690	KMEB-1-230AC-2,5
					5	151691	KMEB-1-230AC-5

Ordering data – Illuminating seal MEB-LD				Technical data → Internet: meb	
	Description	Operating voltage range	Part No.	Type	
	for plug socket with cable KMEB and plug socket MSSD-EB	12 ... 24 V DC	151717	MEB-LD-12-24DC	
		230 V DC/AC ±10%	151718	MEB-LD-230AC	

Ordering data – Padlock LRVS-D			
	Description	Weight [g]	Part No. Type
	for filter or pressure regulators	120	193786 LRVS-D