

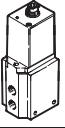

- Multiple pressure ranges selectable
- Special adaptation to individual pressure ranges
- Setpoint value input as analogue voltage or current signal
- Optional setpoint module
- Connection sizes
G $\frac{1}{8}$, G $\frac{1}{4}$, G $\frac{1}{2}$

Proportional pressure regulators MPPE/VPPE/MPPES

Product range overview

Function	Version	Type	Constructional design	Pneumatic connection 1	Nominal size pressurising/exhaust [mm]	Pressure regulation range ¹⁾ [bar]	Setpoint value input		→ Page/Internet
							Voltage type 0 ... 10 V	Current type 4 ... 20 mA	
Pressure regulators	with pilot control via 2/2-way valves (switching valves)								
		MPPE	Pilot-actuated poppet valve	G1/8	5/5	0 ... 1 0 ... 2.5 0 ... 6 0 ... 10	■	■	8
				G1/4	7/7		■	■	
				G1/2	11/12		■	■	
		VPPE	Pilot-actuated poppet valve	G1/8	5/2.5	0.15 ... 6	■	-	4
	with proportional solenoid								
		MPPES	Directly-actuated valve	G1/8	3/2	0 ... 2 0 ... 6 0 ... 10	■	■	14
			Pilot-actuated valve	G1/4	7/7		■	■	
				G1/2	11/12		■	■	

1) Pressure regulation range also by customer request

Proportional pressure regulators MPPE/VPPE/MPPES

Peripherals overview

FESTO

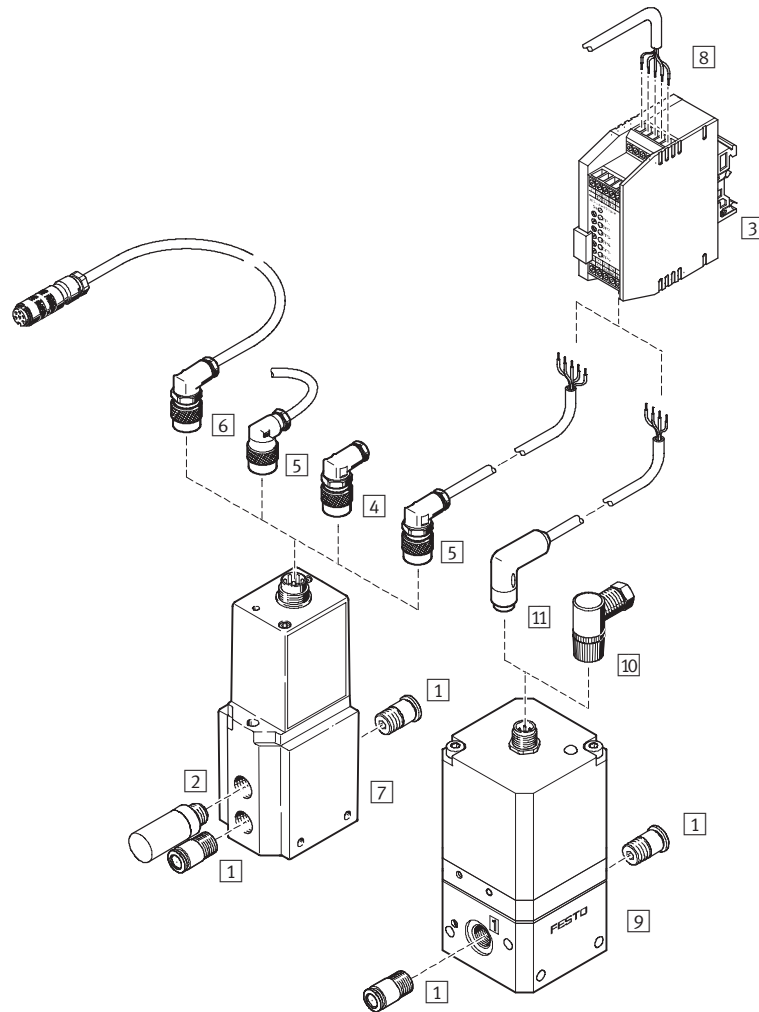

Accessories			
	Brief description	→ Page/Internet	
1	Push-in fitting QS	For connecting compressed air tubing with standard O.D.	quick star
2	Silencer	For fitting in exhaust ports	u
3	Setpoint value module MPZ	For generating 6+1 analogue voltage signals	–
4	Angled plug socket MPPE-3-B	–	22
5	Plug socket with cable KMPE-B	–	22
6	Connecting cable KVIA-MPPE	–	22
7	Proportional pressure regulator MPPE	–	5
8	Digital input/output	For controlling the setpoint module	–
9	Proportional pressure regulator VPPE	–	5
10	Plug socket, angled SIE-WD-TR	–	sie-wd
–	Plug socket, straight SIE-GD	–	sie-gd
11	Plug socket with cable, angled SIM-M12-4WD-5PU	–	22
–	Plug socket with cable, straight SIM-M12-4GD-5PU	–	22



Proportional pressure regulators VPPE

Type codes

		VPPE	-	3	-	1/8	-	6	-	010
Type										
VPPE	Proportional pressure regulator with switching valve head									
Valve function										
3	3-way pressure regulator									
Pneumatic connection										
1/8	Female thread G1/8									
Pressure regulation range										
6	0.15 ... 6 bar									
Analogue setpoint value input										
010	0 ... 10 V									

Proportional pressure regulators VPPE

Technical data

-  - Flow rate
600 l/min
-  - Voltage
21.6 ... 26.4 V DC
-  - Pressure regulation range
0.15 ... 6 bar

- Variants
- Setpoint value input as analogue voltage signal 0 ... 10 V



General technical data		
Pneumatic connection 1 and 2		G $\frac{1}{8}$
Constructional design		Pilot-actuated piston regulator
Sealing principle		Soft
Actuation mode		Electrical
Pilot control mode		Pilot actuated via 2/2-way valves
Type of mounting		Via through-holes
Assembly position		Any
Nominal size	Ventilation	[mm] 5
	Exhaust	[mm] 2.5
Standard nominal flow rate		[l/min] → Graphs
Product weight		[g] 420

Flow rate qn as a function of the output pressure p2

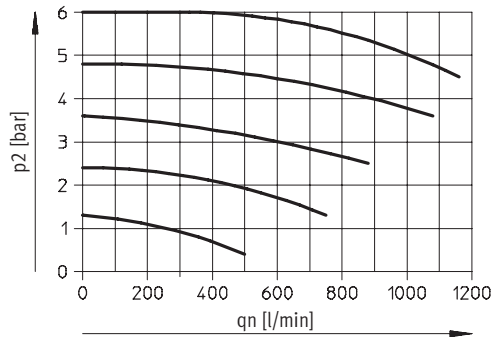

Electrical data	
Electrical connection	Plug, round design, 4-pin, M12x1
Operating voltage range	[V DC] 21.6 ... 26.4
Residual ripple	10 %
Max. electrical power consumption	[W] 2.5
Signal setpoint value input	[V DC] 0 ... 10
Protection against short circuit	For all electrical connections
Protection against polarity reversal	For all electrical connections
Protection class	IP65
CE symbol	EU conformity in accordance with the directive 89/336/EEC (EMC)

Proportional pressure regulators VPPE

Technical data

FESTO

Operating and environmental conditions	
Operating medium	Filtered compressed air, grade of filtration 40µm Neutral gases
Input pressure 1 [bar]	7 ... 8
Pressure regulation range [bar]	0.15 ... 6
Max. hysteresis [bar]	0.15
Ambient temperature [°C]	10 ... 50
Temperature of medium [°C]	10 ... 50
Corrosion resistance class CRC ¹⁾	2

1) Corrosion resistance class 2 according to Festo standard 940 070

Components requiring moderate corrosion resistance. Externally visible parts with primarily decorative surface requirements which are in direct contact with a normal industrial environment or media such as coolants or lubricating agents.

-  - Safety advice

If the power supply cable is interrupted, output pressure is maintained unregulated.

Materials

Sectional view

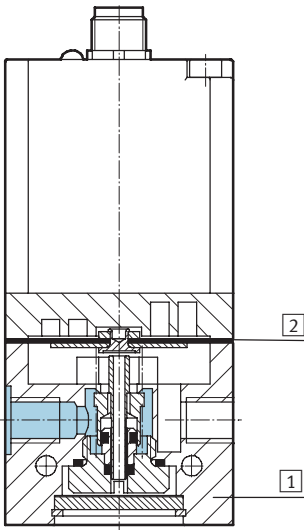

1	Housing	Wrought aluminium alloy
2	Diaphragm	Nitrile rubber

Proportional pressure regulators VPPE

Technical data

FESTO

Dimensions

Download CAD data → www.festo.com

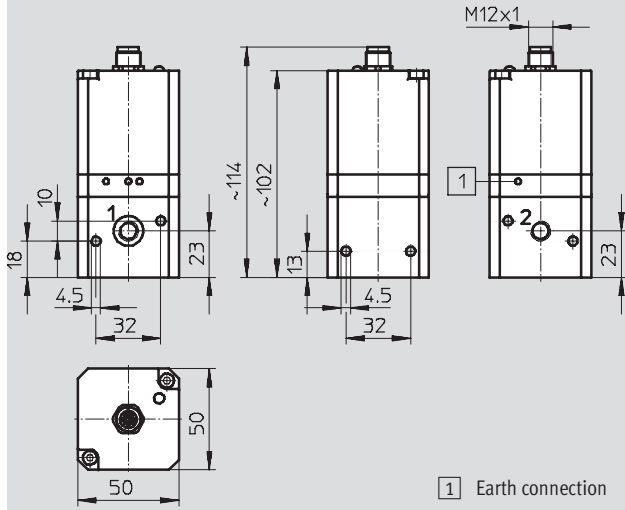

1 Earth connection

M12x1 – Terminal allocation

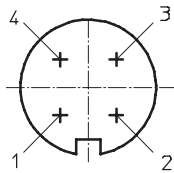

- 1 Power supply
21.6 ... 26.4 V DC
- 2 Nominal value (-)
- 3 GND (-)
- 4 Nominal value (+) 0 ... 10 V DC

Ordering data

Pneumatic connection	Pressure regulation range [bar]	Part No.	Type
G $\frac{1}{8}$	0 ... 6	539 639	VPPE-3- $\frac{1}{8}$ -6-010

Proportional pressure regulators MPPE

Type codes

FESTO

Basic version



MPPE		-	3	-	1/8	-	1	-	010	-	B
Type											
MPPE	Proportional pressure regulator with switching valve										
Valve function											
3	3-way pressure regulator										
Pneumatic connection											
1/8	G1/8										
1/4	G1/4										
1/2	G1/2										
Pressure regulation range											
1	0 ... 1 bar										
2.5	0 ... 2.5 bar										
6	0 ... 6 bar										
10	0 ... 10 bar										
Setpoint value input											
010	Analogue voltage signal										
420	Analogue current signal										
Generation											
B	B series										

Special pressure regulation range by customer request

MPPE		-	3	-	1/8	-	1	-	6	-	010	-	B
Type													
MPPE	Proportional pressure regulator with switching valve												
Valve function													
3	3-way pressure regulator												
Pneumatic connection													
1/8	G1/8												
1/4	G1/4												
1/2	G1/2												
Required pressure at 0 V or 4 mA [bar]													
Required pressure at 10 V or 20 mA [bar]													
Setpoint value input													
010	Analogue voltage signal												
420	Analogue current signal												
Generation													
B	B series												

Proportional pressure regulators MPPE

Technical data

-  Flow rate
350 ... 5,500 l/min
-  Voltage
18 ... 30 V DC
-  Pressure regulation ranges
0 ... 1 bar
0 ... 2.5 bar
0 ... 6 bar
0 ... 10 bar

- Variants
- Setpoint value input as analogue voltage signal 0 ... 10 V
 - Setpoint value input as analogue current signal 4 ... 20 mA



General technical data					
Pneumatic connection		G ¹ / ₈	G ¹ / ₄	G ¹ / ₂	
Constructional design	Pilot actuated piston regulator				
Sealing principle	Soft				
Actuation type	Electrical				
Type of pilot control	Pilot actuated using 2/2-way valves				
Type of mounting	Via through-holes				
Mounting position	Any				
Nominal size	Ventilation	[mm]	5	7	11
	Exhaust	[mm]	5	7	12
Standard nominal flow rate	[l/min]	→ Diagrams			
Product weight	[g]	710	920	2,400	

Flow rate qn as a function of the output pressure p2

Pneumatic connection G¹/₈

Pressure regulation range 0 ... 1 bar

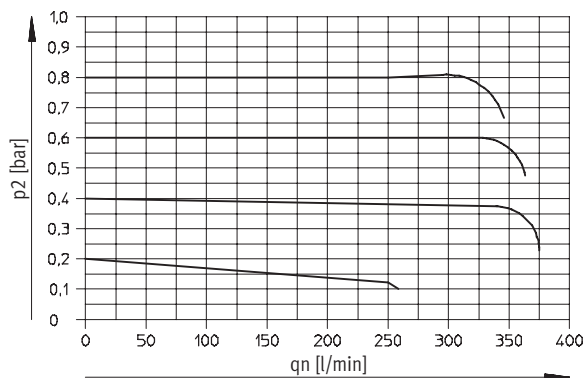

Pressure regulation range 0 ... 2.5 bar

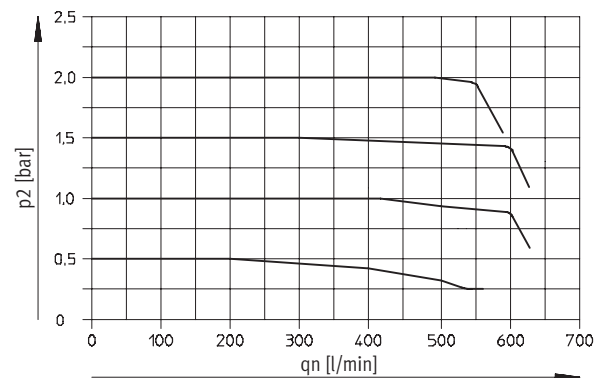

Pressure regulation range 0 ... 6 bar

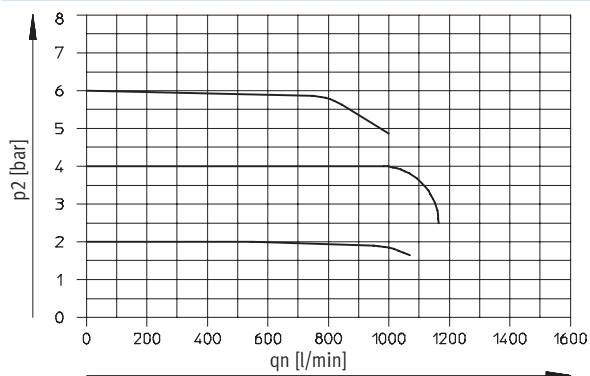

Pressure regulation range 0 ... 10 bar

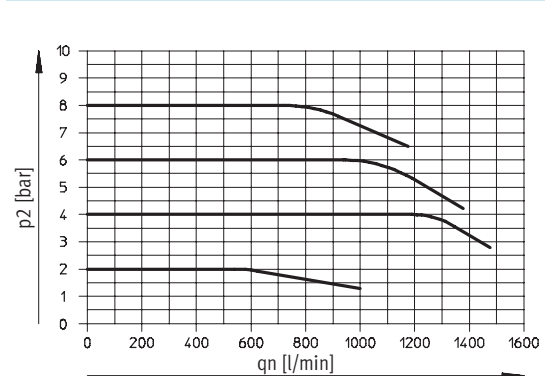

Proportional pressure regulators MPPE

Technical data

FESTO

Flow rate q_n as a function of the output pressure p_2

Pneumatic connection G $\frac{1}{4}$

Pressure regulation range 0 ... 1 bar

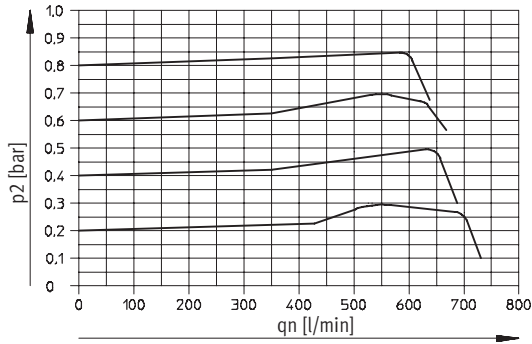

Pressure regulation range 0 ... 2.5 bar

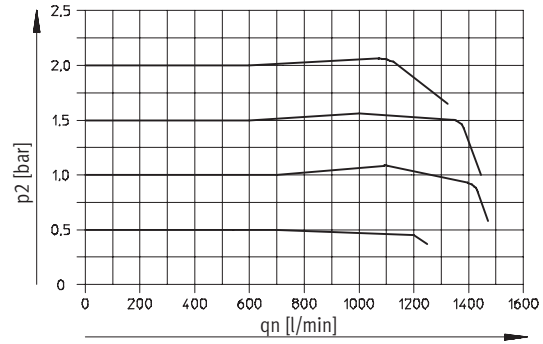

Pressure regulation range 0 ... 6 bar

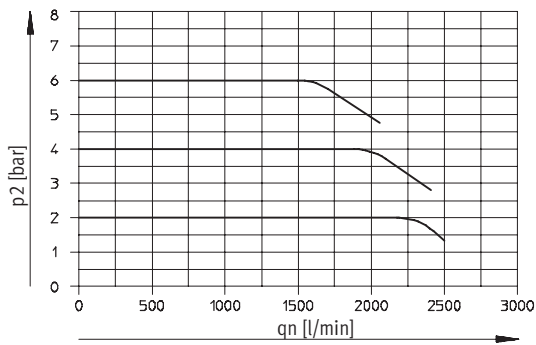

Pressure regulation range 0 ... 10 bar

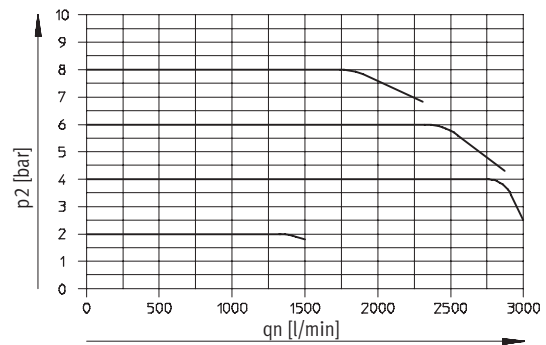

Pneumatic connection G $\frac{1}{2}$

Pressure regulation range 0 ... 1 bar

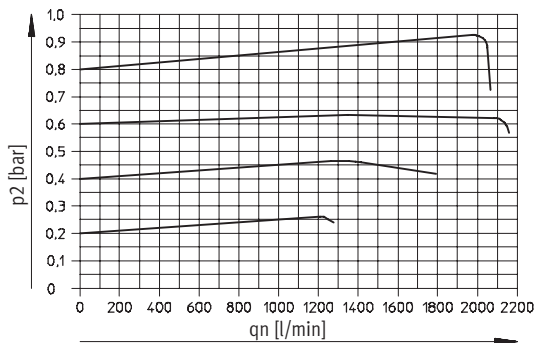

Pressure regulation range 0 ... 2.5 bar

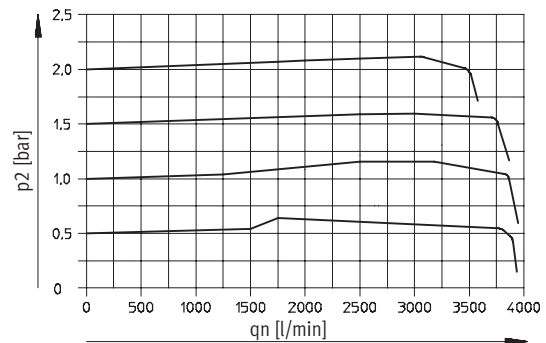

Pressure regulation range 0 ... 6 bar

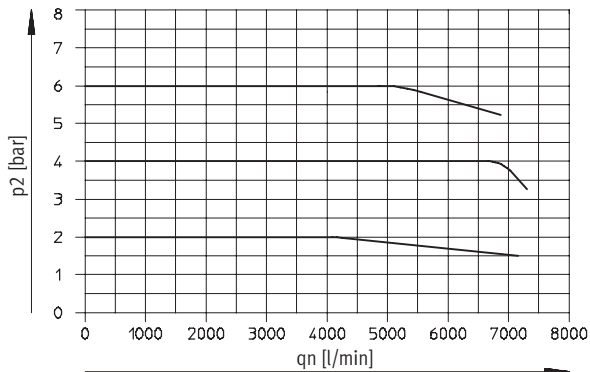

Pressure regulation range 0 ... 10 bar

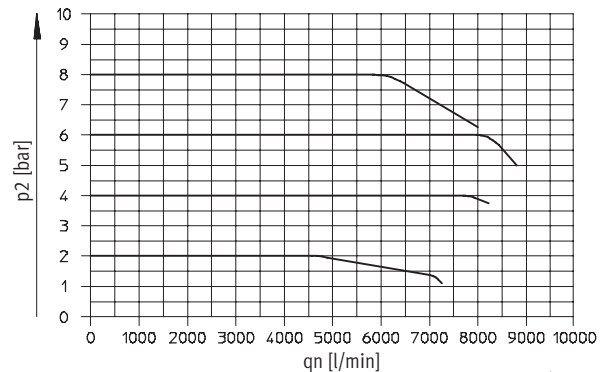

Proportional pressure regulators MPPE

Technical data

Operating and environmental conditions					
Pressure regulation range	[bar]	0 ... 1	0 ... 2.5	0 ... 6	0 ... 10
Operating medium		Filtered compressed air, lubricated or unlubricated Neutral gases			
Input pressure 1	[bar]	1.5 ... 2	3.5 ... 4.5	7 ... 8	11 ... 12
Max. hysteresis	[mbar]	30	40	40	50
Ambient temperature	[°C]	0 ... 50			
Temperature of medium	[°C]	0 ... 60			
Corrosion resistance class CRC ¹⁾		2	2	2	2

- 1) Corrosion resistance class 2 according to Festo standard 940 070
Components requiring moderate corrosion resistance. Externally visible parts with primarily decorative surface requirements which are in direct contact with a surrounding industrial atmosphere or media such as cooling or lubricating agents.

Response times/step responses to output 2 at p _{1max} [s]									
Pressure regulation range [bar]	Volume to output 2	0 ... 1		0 ... 2.5		0 ... 6		0 ... 10	
		On ¹⁾	Off ²⁾	On ¹⁾	Off ²⁾	On ¹⁾	Off ²⁾	On ¹⁾	Off ²⁾
0 l	G1/8	0.095	0.165	0.100	0.180	0.100	0.190	0.125	0.220
	G1/4	0.140	0.225	0.150	0.260	0.150	0.260	0.160	0.280
	G1/2	0.170	0.500	0.170	0.500	0.170	0.510	0.140	0.535
0.7 l	G1/8	0.140	0.250	0.180	0.310	0.220	0.340	0.250	0.380
	G1/4	0.150	0.280	0.170	0.320	0.180	0.360	0.200	0.390
	G1/2	0.120	0.510	0.130	0.520	0.160	0.560	0.180	0.600
2 l	G1/8	0.340	0.730	0.380	0.990	0.430	1.250	0.600	1.160
	G1/4	0.360	0.620	0.400	0.700	0.540	0.930	0.540	1.050
	G1/2	0.330	0.600	0.410	0.720	0.570	1.000	0.540	1.000

- 1) On = 0 ... 90% p_{2max}.
2) Off = 100 ... 10% p_{2max}.

Electrical data					
Pressure regulation range	[bar]	0 ... 1	0 ... 2.5	0 ... 6	0 ... 10
Electrical connection		Plug, round design to DIN 45 326, M16 x 0.75, 8-pin			
Operating voltage range	U _B	[V DC]	18 ... 30		
Residual ripple		10%			
Power consumption	P _{max.}	[W]	3.6 (at 30 V DC and 100% duty cycle)		
Signal setpoint value input	Voltage	U _w	[V DC]	0 ... 10	
	Current	I _w	[mA]	4 ... 20	
Signal actual value output	Voltage	U _x	[V DC]	0 ... 10	
	Current	I _x	[mA]	4 ... 20	
Signal actual value input external	Voltage	U _{x,ext.}	[V DC]	0 ... 10	
	Current	I _{x,ext.}	[mA]	4 ... 20	
Protection class to DIN 60 529		IP65 (with connection socket)			
Safety note		If the power supply cable is interrupted, output pressure is maintained unregulated			
Protection against polarity reversal	Setpoint value input	For all electrical connections			
	Voltage signal 0 ... 10 V	Setpoint value input	For operating voltage		
	Current signal 4 ... 20 mA				
Protection against short circuit		No			

Proportional pressure regulators MPPE

Technical data

FESTO

Materials

Sectional view

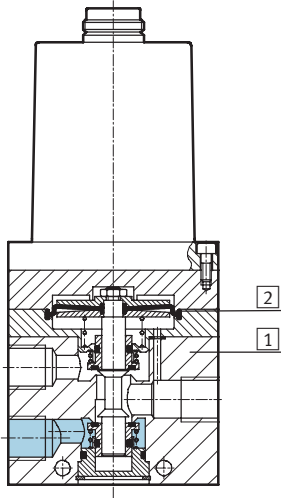

1	Housing	Wrought aluminium alloy
2	Diaphragm	Nitrile rubber

Dimensions

Download CAD data → www.festo.com

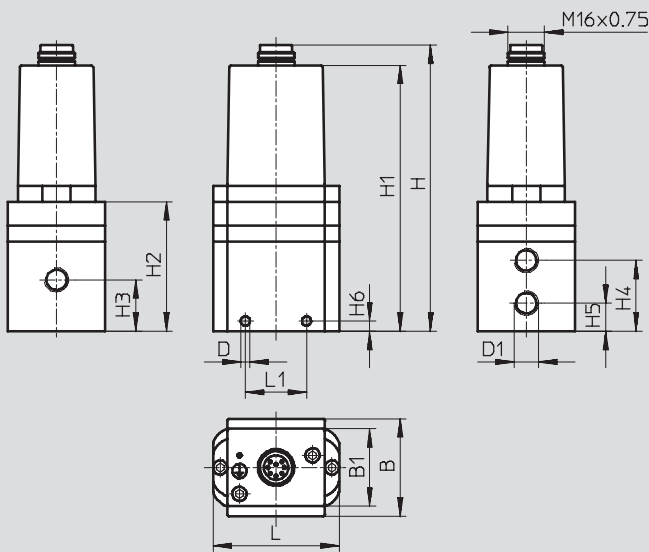

Pneumatic connection D1	B	B1	D Ø	H	H1	H2	H3	H4	H5	H6	L	L1
G ¹ / ₈	38	-	4.5	129.1	119.1	60.2	18.8	26.8	9.3	4	62	34
G ¹ / ₄	48	38	4.5	140.7	130.7	63.6	25.3	34.8	13.8	5	62	30
G ¹ / ₂	76	38	7	194.6	184.6	117.5	53	74	32	18	86	50

Proportional pressure regulators MPPE

Technical data

FESTO

Terminal allocation

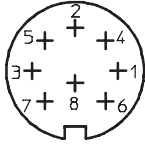

1	WH	$X_{\text{ext,in}}$ (external actual value input)
2	BN	GND
3	GN	GND
4	YE	W_{in} (setpoint value input)
5	GY	10 V _{out} (external potentiometer supply)
6	PK	X_{out} (actual value output)
7	RD	24 V DC (supply voltage)
8	BU	GND

Switching function

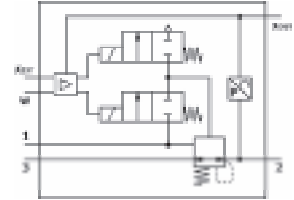

Ordering data					
Pneumatic connection	Pressure regulation range [bar]	Voltage type 0 ... 10 V		Current type 4 ... 20 mA	
		Part No.	Type	Part No.	Type
Basic version					
G ¹ / ₈	0 ... 1	161 160	MPPE-3-1/8-1-010-B	161 163	MPPE-3-1/8-1-420-B
	0 ... 2.5	164 315	MPPE-3-1/8-2,5-010-B	164 316	MPPE-3-1/8-2,5-420-B
	0 ... 6	161 161	MPPE-3-1/8-6-010-B	161 164	MPPE-3-1/8-6-420-B
	0 ... 10	161 162	MPPE-3-1/8-10-010-B	161 165	MPPE-3-1/8-10-420-B
G ¹ / ₄	0 ... 1	161 166	MPPE-3-1/4-1-010-B	161 169	MPPE-3-1/4-1-420-B
	0 ... 2.5	164 317	MPPE-3-1/4-2,5-010-B	164 318	MPPE-3-1/4-2,5-420-B
	0 ... 6	161 167	MPPE-3-1/4-6-010-B	161 170	MPPE-3-1/4-6-420-B
	0 ... 10	161 168	MPPE-3-1/4-10-010-B	161 171	MPPE-3-1/4-10-420-B
G ¹ / ₂	0 ... 1	161 172	MPPE-3-1/2-1-010-B	161 175	MPPE-3-1/2-1-420-B
	0 ... 2.5	164 319	MPPE-3-1/2-2,5-010-B	164 320	MPPE-3-1/2-2,5-420-B
	0 ... 6	161 173	MPPE-3-1/2-6-010-B	161 176	MPPE-3-1/2-6-420-B
	0 ... 10	161 174	MPPE-3-1/2-10-010-B	161 177	MPPE-3-1/2-10-420-B
Special adaptation type¹⁾					
G ¹ / ₈	0 ... 10	164 330	MPPE-3-1/8-...-...-010-B ¹⁾	164 330	MPPE-3-1/8-...-...-420-B ¹⁾
G ¹ / ₄	0 ... 10	164 331	MPPE-3-1/4-...-...-010-B ¹⁾	164 331	MPPE-3-1/4-...-...-420-B ¹⁾
G ¹ / ₂	0 ... 10	164 332	MPPE-3-1/2-...-...-010-B ¹⁾	164 332	MPPE-3-1/2-...-...-420-B ¹⁾

1) The special adaptation type allows a lower pressure to be assigned to the setpoint value 0 V or 4 mA and an upper pressure to be assigned to the setpoint value 10 V or 20 mA. Upper and lower pressure by customer request.

Proportional pressure regulators MPPES

Type codes

Basic version



		MPPES	-	3	-	1/8	-	1	-	010
Type										
MPPES	Proportional pressure regulator with proportional solenoid									
Valve function										
3	3-way pressure regulator									
Pneumatic connection										
1/8	G1/8									
1/4	G1/4									
1/2	G1/2									
Pressure regulation range										
2	0 ... 2 bar									
6	0 ... 6 bar									
10	0 ... 10 bar									
Setpoint value input										
010	Analogue voltage signal									
420	Analogue current signal									

Special pressure regulation range by customer request

		MPPES	-	3	-	1/8	-	1	-	6	-	010
Type												
MPPES	Proportional pressure regulator with proportional solenoid											
Valve function												
3	3-way pressure regulator											
Pneumatic connection												
1/8	G1/8											
1/4	G1/4											
1/2	G1/2											
Required pressure at 0 V or 4 mA [bar]												
Required pressure at 10 V or 20 mA [bar]												
Setpoint value input												
010	Analogue voltage signal											
420	Analogue current signal											

Proportional pressure regulators MPPES

Technical data

-  - Flow rate
230 ... 5,500 l/min
-  - Voltage
18 ... 30 V DC
-  - Pressure regulation ranges
0 ... 2 bar
0 ... 6 bar
0 ... 10 bar

- Variants
- Setpoint value input as analogue voltage signal 0 ... 10 V
 - Setpoint value input as analogue current signal 4 ... 20 mA



General technical data			
Pneumatic connection	G ¹ / ₈	G ¹ / ₄	G ¹ / ₂
Constructional design	Directly actuated piston regulator	Pilot actuated piston regulator	
Sealing principle	Soft		
Actuation type	Electrical		
Type of pilot control	Direct	Pilot actuated	
Type of mounting	Via through-holes		
Mounting position	Any		
Nominal size	Ventilation [mm]	3	7
	Exhaust [mm]	2	7
Standard nominal flow rate	[l/min]	→ Diagrams	
Product weight	[g]	1 310	2 670

Flow rate qn as a function of the output pressure p2

Pneumatic connection G¹/₈

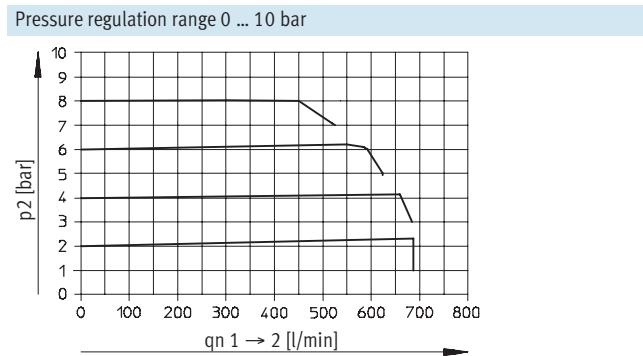
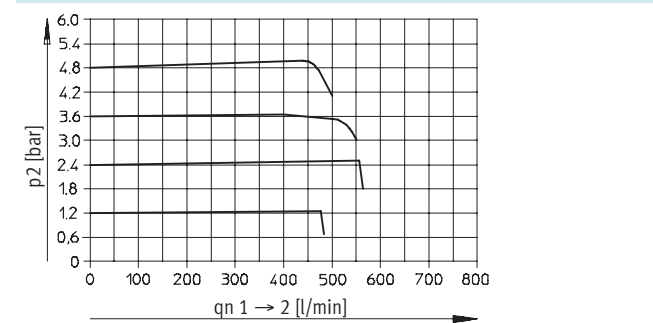
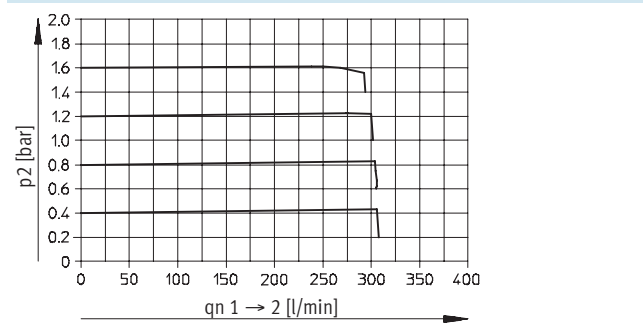

Proportional pressure regulators MPPES

Technical data

FESTO

Flow rate q_n as a function of the output pressure p_2

Pneumatic connection G $\frac{1}{4}$

Pressure regulation range 0 ... 2 bar

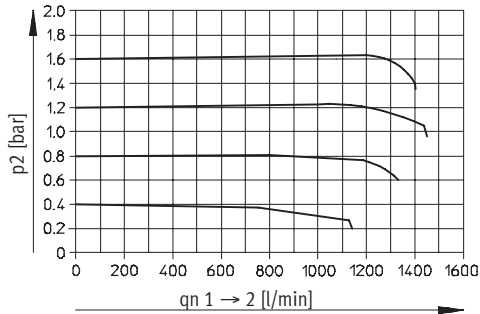

Pressure regulation range 0 ... 6 bar

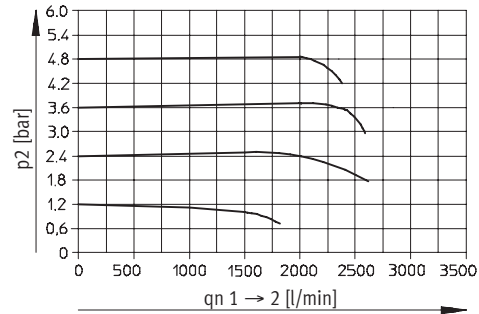

Pressure regulation range 0 ... 10 bar

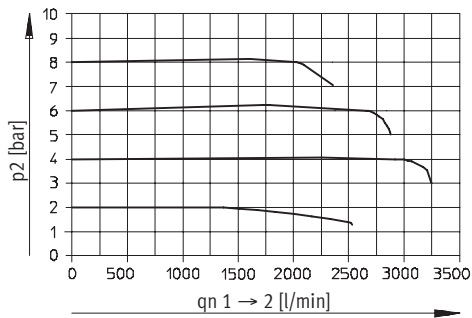

Pneumatic connection G $\frac{1}{2}$

Pressure regulation range 0 ... 2 bar

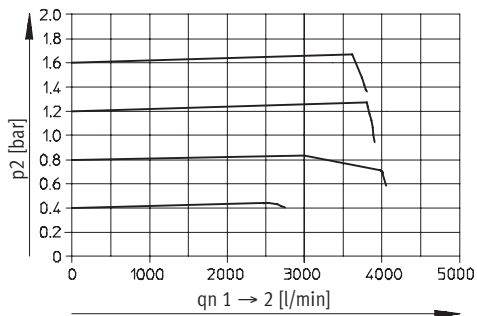

Pressure regulation range 0 ... 6 bar

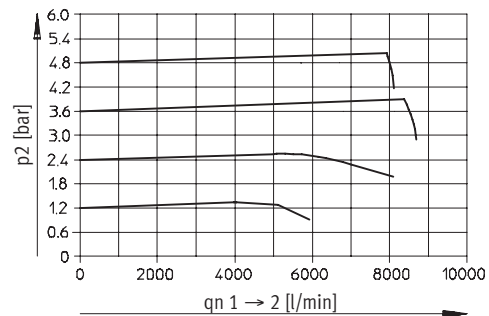

Pressure regulation range 0 ... 10 bar

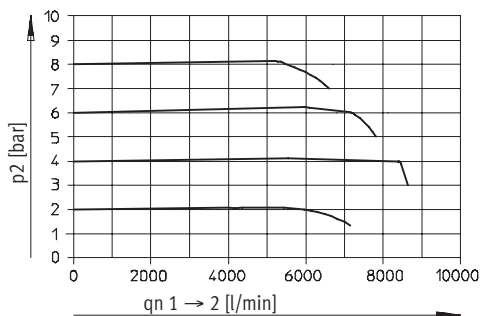

Proportional pressure regulators MPPES

Technical data

Operating and environmental conditions				
Pressure regulation range	[bar]	0 ... 2	0 ... 6	0 ... 10
Operating medium		Filtered compressed air, lubricated or unlubricated Neutral gases		
Input pressure 1	[bar]	3 ... 4	7 ... 8	11 ... 12
Max. hysteresis	[mbar]	10	50	50
Ambient temperature	[°C]	0 ... 50		
Temperature of medium	[°C]	0 ... 60		
Corrosion resistance class CRC ¹⁾		2	2	2

- 1) Corrosion resistance class 2 according to Festo standard 940 070
Components requiring moderate corrosion resistance. Externally visible parts with primarily decorative surface requirements which are in direct contact with a surrounding industrial atmosphere or media such as cooling or lubricating agents.

Response times/step responses to output 2 at p _{1max} [s]							
Pressure regulation range [bar]	Volume to output 2	0 ... 2		0 ... 6		0 ... 10	
		On ¹⁾	Off ²⁾	On ¹⁾	Off ²⁾	On ¹⁾	Off ²⁾
0 l	G1/8	0.220	0.410	0.210	0.280	0.200	0.290
	G1/4	0.200	0.890	0.200	0.640	0.200	0.360
	G1/2	0.220	1.000	0.230	0.660	0.230	0.450
2 l	G1/8	0.660	2.530	1.200	5.760	1.370	6.300
	G1/4	0.200	1.000	0.450	0.760	0.460	0.900
	G1/2	0.320	1.000	0.340	0.570	0.350	0.630
10 l	G1/8	2.700	2.800	5.150	24.000	5.800	27.000
	G1/4	0.900	2.700	1.500	3.000	1.900	3.400
	G1/2	0.800	1.400	1.100	1.500	1.300	1.800

- 1) On = 0 ... 90% p_{2max}.
2) Off = 100 ... 10% p_{2max}.

Electrical data				
Pressure regulation range	[bar]	0 ... 2	0 ... 6	0 ... 10
Electrical connection		Plug, round design to DIN 45 326, M16 x 0.75, 8-pin		
Operating voltage range	U _B	[V DC]	18 ... 30	
Residual ripple			10%	
Power consumption	P _{max.}	[W]	20 (at 30 V DC)	
Signal setpoint value input	Voltage	U _w	[V DC]	0 ... 10
	Current	I _w	[mA]	4 ... 20
Signal actual value input	Voltage	U _x	[V DC]	0 ... 10
	Current	I _x	[mA]	4 ... 20
Signal actual value input external	Voltage	U _{x,ext.}	[V DC]	0 ... 10
	Current	I _{x,ext.}	[mA]	4 ... 20
Protection class to DIN 60 529			IP65 (with connection socket)	
Safety note			If the power supply cable is interrupted, output pressure is maintained unregulated.	
Protection against polarity reversal	Setpoint value input	For all electrical connections		
	Voltage signal 0 ... 10 V	Setpoint value input	For operating voltage	
	Current signal 4 ... 20 mA			
Protection against short circuit			No	

Proportional pressure regulators MPPES

Technical data

FESTO

Materials

Sectional view

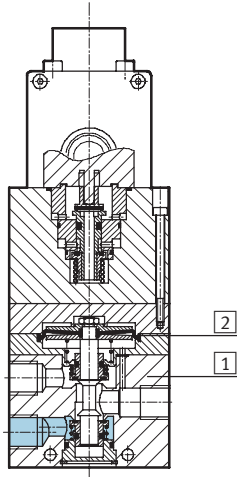

1	Housing	Wrought aluminium alloy
2	Diaphragm	Nitrile rubber

-  - Note

If the power supply cable is interrupted, output pressure is maintained unregulated.

Dimensions

Download CAD data → www.festo.com

MPPES-3-1/8-...

MPPES-3-1/4-...
MPPES-3-1/2-...

MPPES-3-1/4-...
MPPES-3-1/2-...

MPPES-3-1/8-...

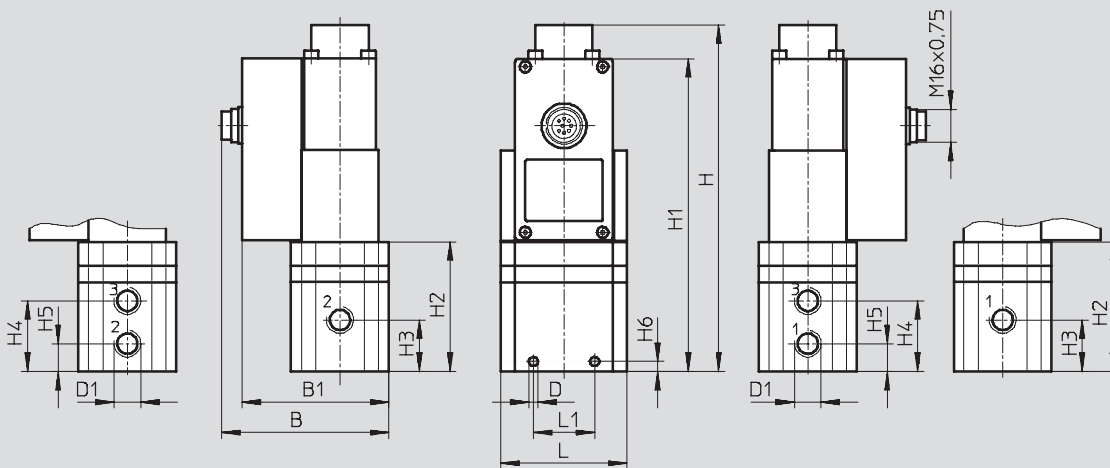

Pneumatic connection D1	B	B1	D Ø	H	H1	H2	H3	H4	H5	H6	L	L1
G1/8	77.1	67.1	4.4	116.5	100	55	34	45	23	4	62	34
G1/4	82.1	72.1	4.5	170.2	153.7	63.7	25.3	34.8	13.8	5	62	30
G1/2	96.1	86.1	7	227.1	210.6	120.6	53	74	32	18	86	50

Proportional pressure regulators MPPES

Technical data

FESTO

Connections

Terminal allocation

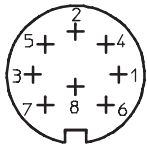

1	WH	n. c.
2	BN	GND
3	GN	GND
4	YE	W_{in} (setpoint value input)
5	GY	n. c.
6	PK	X_{out} (actual value output)
7	RD	24 V DC (supply voltage)
8	BU	GND

Switching function

MPPES-3-1/8-...

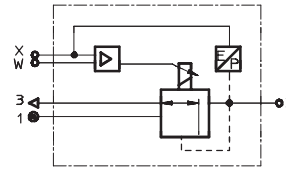

MPPES-3-1/4-.../MPPES-3-1/2-...

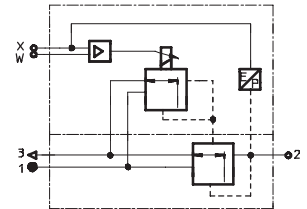

Ordering data

Pneumatic connection	Pressure regulation range [bar]	Voltage type 0 ... 10 V		Current type 4 ... 20 mA	
		Part No.	Type	Part No.	Type
Basic version					
G ¹ / ₈	0 ... 2	187 350	MPPES-3-1/8-2-010	187 351	MPPES-3-1/8-2-420
	0 ... 6	187 352	MPPES-3-1/8-6-010	187 353	MPPES-3-1/8-6-420
	0 ... 10	187 348	MPPES-3-1/8-10-010	187 349	MPPES-3-1/8-10-420
G ¹ / ₄	0 ... 2	187 335	MPPES-3-1/4-2-010	187 336	MPPES-3-1/4-2-420
	0 ... 6	187 337	MPPES-3-1/4-6-010	187 338	MPPES-3-1/4-6-420
	0 ... 10	187 333	MPPES-3-1/4-10-010	187 334	MPPES-3-1/4-10-420
G ¹ / ₂	0 ... 2	187 328	MPPES-3-1/2-2-010	187 329	MPPES-3-1/2-2-420
	0 ... 6	187 330	MPPES-3-1/2-6-010	187 331	MPPES-3-1/2-6-420
	0 ... 10	187 326	MPPES-3-1/2-10-010	187 327	MPPES-3-1/2-10-420
Special adaptation type¹⁾					
G ¹ / ₈	0 ... 10	187 347	MPPES-3-1/8-PU-PO-010	187 762	MPPES-3-1/8-PU-PO-420
G ¹ / ₄	0 ... 10	187 339	MPPES-3-1/4-PU-PO-010	187 744	MPPES-3-1/4-PU-PO-420
G ¹ / ₂	0 ... 10	187 332	MPPES-3-1/2-PU-PO-010	187 735	MPPES-3-1/2-PU-PO-420

1) The special adaptation type allows a lower pressure PU to be assigned to the setpoint value 0 V or 4 mA and an upper pressure PO to be assigned to the setpoint value 10 V or 20 mA. PU and PO by customer request.

Proportional pressure regulators MPPE/VPPE/MPPES

FESTO

Accessories

Setpoint module MPZ

 Voltage
20 ... 30 V DC

Function

- Generation of 6+1 analogue setpoint values for the proportional pressure regulators MPPE, MPPES and MPYE
- Digital controller
- Output voltage adjustable via spindle potentiometer



General technical data			
Mode of operation		Digital-analogue circuit with analogue output	
Electrical connection		Screw terminal	
Connection cross section		[mm ²]	2.5
Operating voltage range		[V DC]	20 ... 30
Adjustable output voltage		[V DC]	0 ... 10
Max. output current		[mA]	27
Power consumption at 24 V DC		[W]	1.5
Supply setpoint value adjustment	Voltage	[V]	10 ... 10.6
	Current	[mA]	6 ... 6.36
External setpoint input	Voltage	[V DC]	0 ... 10
	Potentiometer	[kΩ]	2.5 ... 10
Setpoint controller	Input resistance	[kΩ]	3
Residual ripple		[%]	Max. 10
Display	Ready	Green LED	
	Setpoint active	Yellow LED	
Type of mounting		On H-rail	
Assembly position		Any	
Product weight		[g]	80

Operating and environmental conditions			
Ambient temperature		[°C]	0 ... 60
Protection class		IP20	
CE symbol (declaration of conformity)		In accordance with EU EMC directive	
Corrosion resistance class CRC ¹⁾		2	

1) Corrosion resistance class 2 according to Festo standard 940 070
Components requiring moderate corrosion resistance. Externally visible parts with primarily decorative surface requirements which are in direct contact with a normal industrial environment or media such as coolants or lubricating agents

Proportional pressure regulators MPPE/VPPE/MPPES

Accessories



Connections and control elements

Connections			Priority
31	Activate setpoint 1	SP1	1 (highest)
32	Activate setpoint 2	SP2	2
33	Activate setpoint 3	SP3	3
34	Activate setpoint 4	SP4	4
35	Activate setpoint 5	SP5	5
11	Activate setpoint 6	SP6	6
13	Control line	0 V	-
21	Control line	0 V	-
22	External setpoint input	$U_{w, in} = 0 \dots 10 \text{ V DC}$	7 (lowest)
23	Control line	10 V DC	-
24	Screening	PE	-
41	Control line	0 V DC	-
42	Setpoint output	$U_{w, out}$	-
43	Power supply	-	-
45	Power supply	+	-

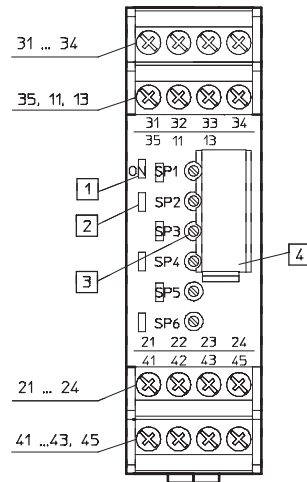

- 1 Operational status display, green LED
- 2 Setpoint display active (SP1 ... SP6), yellow LED
- 3 Setpoint potentiometer SP1 ... SP6
- 4 Inscription label

Dimensions

Download CAD data → www.festo.com

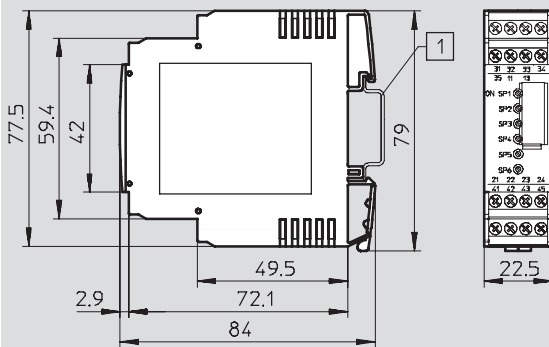

- 1 H-rail to DIN EN 60715



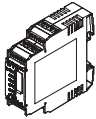



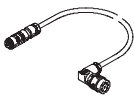
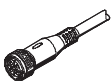

Ordering data

	Description	Part No.	Type
	Setpoint module for generating 6 + 1 analogue voltage signals	546 224	MPZ-1-24DC-SGH-6-SW

Proportional pressure regulators MPPE/VPPE/MPPES

Accessories

FESTO

Ordering data				
	Description	Cable length [m]	Part No.	Type
Connecting cable Technical data → Internet: kvia				
	Connecting cable to the analogue module of valve terminal type 03/04	5	163 882	KVIA-MPPE-5
		10	163 883	KVIA-MPPE-10
Plug socket with cable Technical data → Internet: sim-m12				
	Straight, 4-pin, M12x1	5	164 259	SIM-M12-4GD-5-PU
Plug socket with cable Technical data → Internet: sim-m12				
	Angled, 4-pin, M12x1	5	164 258	SIM-M12-4WD-5-PU
Plug socket with cable Technical data → Internet: kmppe				
	Angled, 8-pin, M16x0.75	2.5	161 879	KMPPE-B-2,5
		5	161 878	KMPPE-B-5
Sensor socket Technical data → Internet: sie-gd				
	Straight, 4-pin, M12x1	–	18 494	SIE-GD
Sensor socket Technical data → Internet: sie-wd				
	Angled, 4-pin, M12x1	–	12 956	SIE-WD-TR
Angled plug socket Technical data → Internet: mppe				
	Angled, 8-pin, M16x0.75	–	161 839	MPPE-3-B
Push-in fitting Technical data → Internet: quick star				
	For connecting compressed air tubing with standard external diameters			
Silencer Technical data → Internet: u				
	For fitting in exhaust ports			
Reducing nipple				
	–			

1) Max. 10 m