

Parallel grippers HGPL, robust, with long stroke

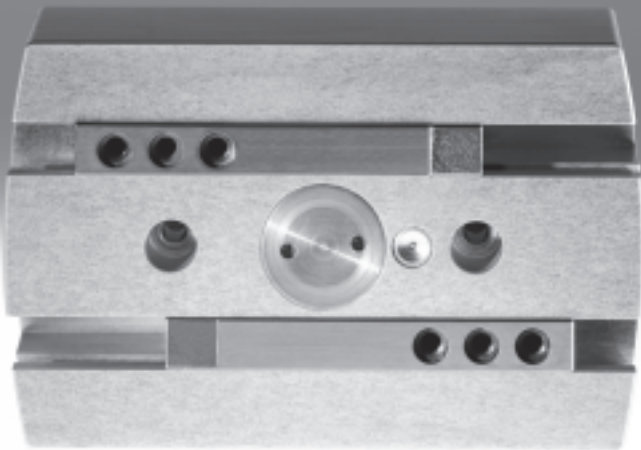

Parallel grippers HGPL, robust, with long stroke

Key features

At a glance

- Space-saving and suitable for high forces
 - Two parallel and opposing pistons move the gripper jaws directly and without loss of force
- Reliable
 - A pinion that synchronises the movement of both gripper jaws ensures controlled, precise and centred gripping
 - The space-saving design of the parallel gripper jaws permits a long guide length for the gripper jaws
- Sturdy
 - The T-slot in combination with a long guide length allows the gripper jaws to withstand high forces and torques
- Flexible range of applications
 - Double-acting gripper suitable for external and internal gripping.
 - Versatile mounting options and compressed air connections
 - Opening stroke can be adjusted to optimise time

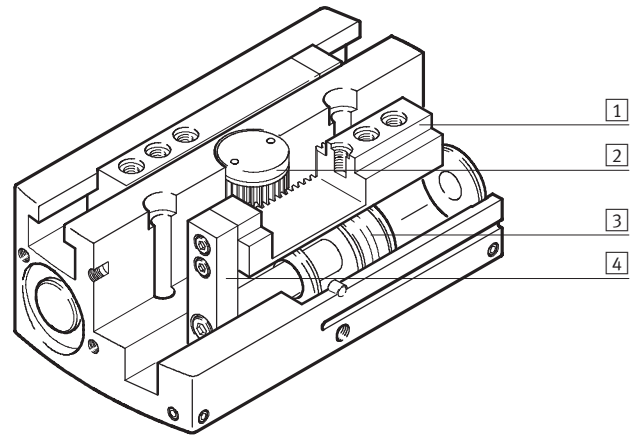

- 1 Gripper jaw
- 2 Synchronising gear
- 3 Piston with magnet
- 4 Driver

-  - Note

Sizing software
Gripper selection
→ www.festo.com

Versatile compressed air connections

Direct from the front

Via adapter plate from underneath

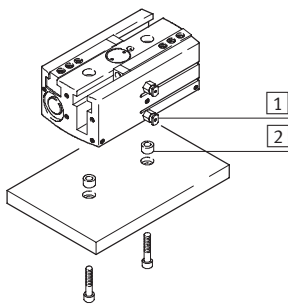

- 1 Compressed air connections
- 2 Centring sleeves
- 3 O-rings

Mounting options

Direct mounting from above

from underneath

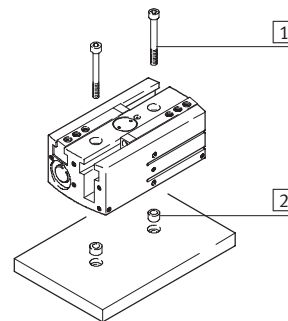

- 1 Mounting screws
- 2 Centring sleeves

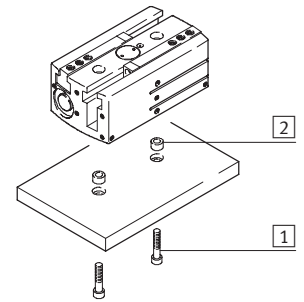

-  - Note

Grippers are not designed for the following or similar applications:

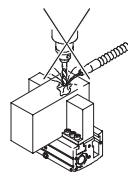

- Aggressive media
- Machining

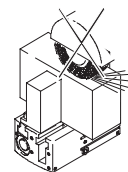

- Grinding dust

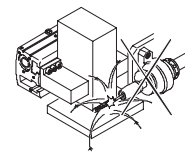

- Welding spatter

Parallel grippers HGPL, robust, with long stroke

Peripherals overview and type codes

Peripherals overview

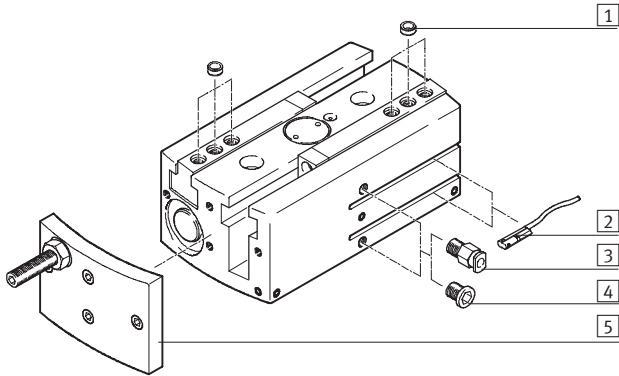

System product for handling and assembly technology

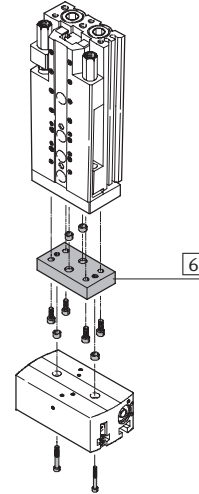

Accessories		
Type	Brief description	→ Page/Internet
1 Centring sleeve ZBH	For centring when attaching gripper fingers	16
2 Proximity sensor SME/SMT-10	For sensing the piston position	17
3 Push-in fitting QS	For connecting compressed air tubing with standard external diameters	quick star
4 Blanking plug B	For sealing compressed air connections when using air connections at the front	16
5 Stroke reducing plate HGPL-HR-...	For reducing the opening stroke	15
6 -	Drive/gripper connections	adapter kit
- Unmachined gripper finger BUB-HGPL	Unmachined part specially matched to the gripper jaws for custom building of gripper fingers	16

Type codes

HGPL		-	14	-	40	-	A
Type							
HGPL	Parallel gripper						
Size							
Stroke [mm]							
Position sensing							
A	For proximity sensing						

Parallel grippers HGPL, robust, with long stroke

FESTO

Technical data

Function
Double-acting
HGPL...-A

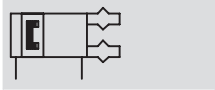

www.festo.com
Wearing parts kits
→ 14



- - Size
14 ... 40 mm
- - Stroke
80 ... 160 mm

General technical data							
Size	14		25		40		
Design	Synchronised pneumatic pistons Guided motion sequence						
Mode of operation	Double-acting						
Gripper function	Parallel						
Number of gripper jaws	2						
Max. applied load per external gripper finger ¹⁾ [N]	0.8		2.5		4.2		
Stroke per gripper jaw [mm]	40	80	40	80	40	80	
Pneumatic connection	M5						
Repetition accuracy ²⁾ [mm]	< 0.03						
Max. interchangeability [mm]	< 0.2						
Max. gripper jaw backlash ³⁾ [mm]	< 0.05						
Max. operating frequency [Hz]	< 1						
Rotational symmetry [mm]	< Ø 0.2						
Position sensing	For proximity sensing						
Type of mounting	Via through-holes and centring sleeves With female thread and centring sleeves						
Fitting position	Any						

- 1) Valid for unthrottled operation
- 2) End-position drift under constant conditions of use with 100 consecutive strokes in the direction of movement of the gripper jaws
- 3) In the direction of the gripper jaw movement

Operating and environmental conditions		
Operating pressure [bar]	3 ... 8	
Operating medium	Filtered compressed air, lubricated or unlubricated	
Ambient temperature ¹⁾ [°C]	+5 ... +60	
Corrosion resistance class CRC ²⁾	2	

- 1) Note operating range of proximity sensors
- 2) Corrosion resistance class 2 according to Festo standard 940 070
Components requiring moderate corrosion resistance. Externally visible parts with primarily decorative surface requirements which are in direct contact with a normal industrial environment or media such as coolants or lubricating agents

Weight [g]						
Size	14		25		40	
Stroke per gripper jaw	40 mm	440	1400	3300		
	80 mm	720	2200	4800		

Parallel grippers HGPL, robust, with long stroke

Technical data

Materials

Sectional view

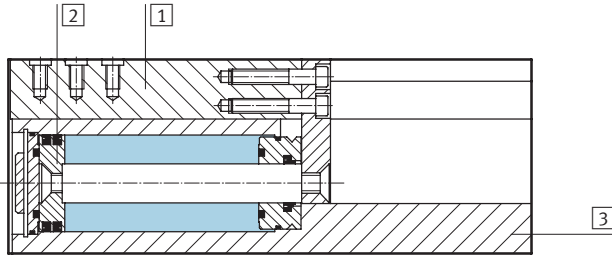

Parallel gripper		
1	Gripper jaw	Hardened steel, CitroX-coated
2	Piston	High-alloy steel
3	Housing	Wrought aluminium alloy with CompCote
-	Seals	Nitrile rubber, polyurethane
-	Note on materials	Free of copper, PTFE and silicone Conforms to RoHS

Gripping force [N] at 6 bar

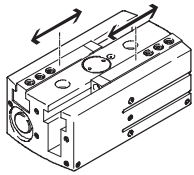

Size	Stroke	14	25	40
Gripping force per gripper jaw				
Opening	40 mm	60	180	440
	80 mm	64	205	520
Closing	40 mm	80	240	550
	80 mm	80	255	605
Total gripping force				
Opening	40 mm	120	360	880
	80 mm	128	410	1040
Closing	40 mm	160	480	1100
	80 mm	160	510	1210

Characteristic load values at the gripper jaws

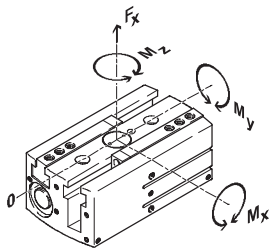

The indicated permissible forces and torques refer to a single gripper jaw. The indicated values include the lever arm, additional applied loads caused

by the workpiece or external gripper fingers, as well as forces which occur during movement. The zero coordinate line (gripper finger guide slot) must be

taken into consideration for the calculation of torques.

Size		14	25	40
Max. permissible force F_z	[N]	500	1500	2500
Max. permissible torque M_x	[Nm]	35	100	125
Max. permissible torque M_y	[Nm]	35	60	80
Max. permissible torque M_z	[Nm]	35	70	100

Parallel grippers HGPL, robust, with long stroke

Technical data

FESTO

Mass moment of inertia [kgm²x10⁻⁴]

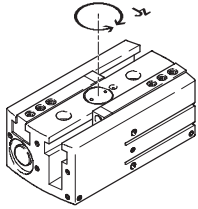

Mass moment of inertia [kgm²x10⁻⁴] for parallel grippers in relation to the central axis with no load.

Size		14	25	40
Stroke per gripper jaw	40 mm	4.69	18.88	66.83
	80 mm	21.93	78.7	198.87

Opening and closing times [ms] at 6 bar

without external gripper fingers

with external gripper fingers

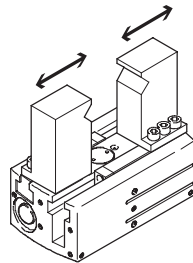
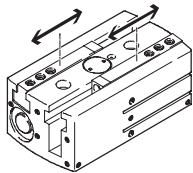

The indicated opening and closing times [ms] have been measured at room temperature and at 6 bar operating pressure with horizontally mounted additional gripper fingers.

The grippers must be throttled for greater applied loads. Opening and closing times must then be adjusted correspondingly.

Size		14	25	40
without external gripper fingers – opening				
Stroke per gripper finger	40 mm	104	194	238
	80 mm	234	360	414
without external gripper fingers – closing				
Stroke per gripper finger	40 mm	86	192	205
	80 mm	217	366	438
with external gripper fingers as a function of applied load				
Stroke per gripper finger	40 mm			
Applied load	1 N	108	–	–
	2 N	136	–	–
	3 N	167	210	–
	4 N	192	243	–
	5 N	–	272	260
	6 N	–	–	284
	8 N	–	–	328
	Stroke per gripper finger	80 mm		
Applied load	1 N	243	–	–
	2 N	343	–	–
	3 N	420	401	–
	4 N	485	463	–
	5 N	–	518	478
	6 N	–	–	524
	8 N	–	–	604

Parallel grippers HGPL, robust, with long stroke

Technical data

Gripping force F_{Grip} per gripper jaw as a function of operating pressure and lever arm x

Gripping forces related to operating pressure and lever arm can be determined for the various sizes using the following graphs.

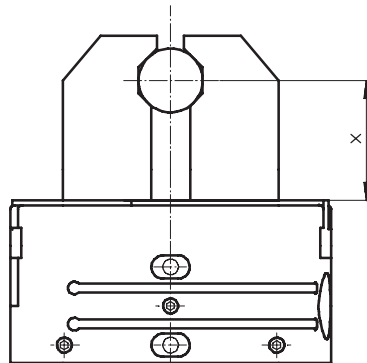

As external gripper: Closing operation

HGPL-14-40-A

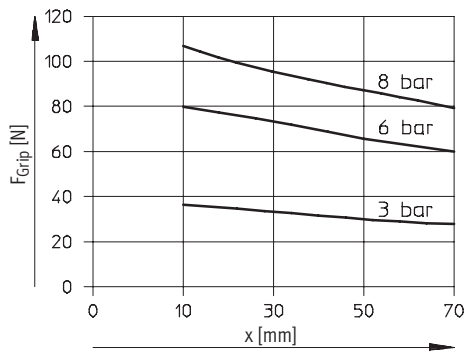

HGPL-14-80-A

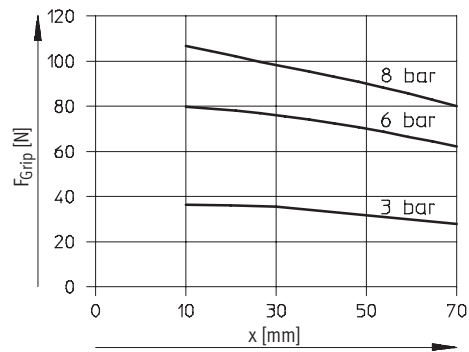

HGPL-25-40-A

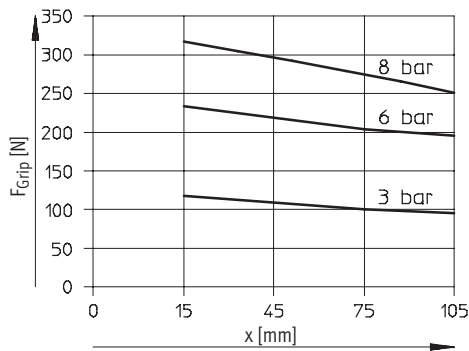

HGPL-25-80-A

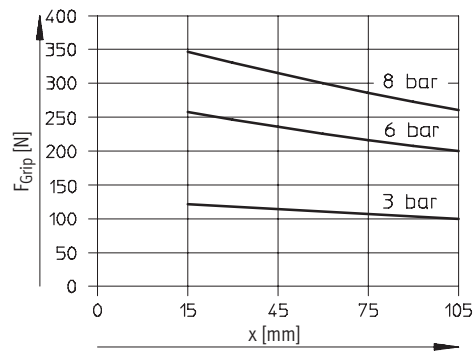

HGPL-40-40-A

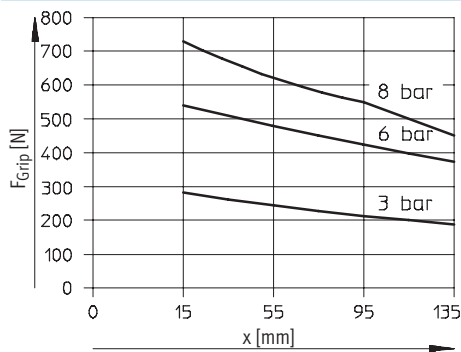

HGPL-40-80-A

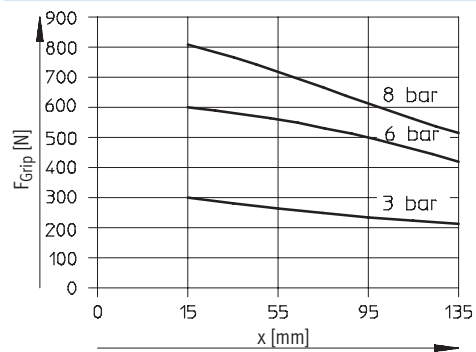

Parallel grippers HGPL, robust, with long stroke

Technical data

FESTO

Gripping force F_{Grip} per gripper jaw as a function of operating pressure and lever arm x
As internal gripper: Opening operation

HGPL-14-40-A

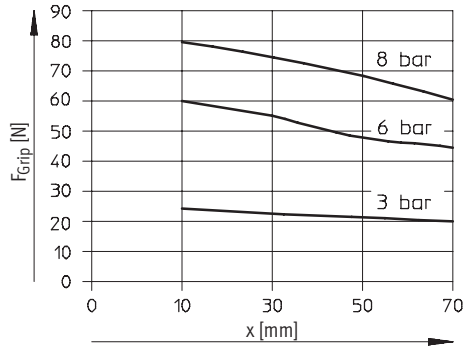

HGPL-14-80-A

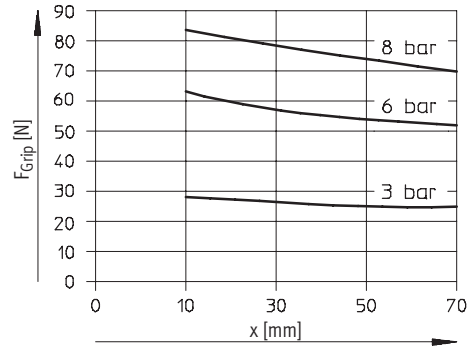

HGPL-25-40-A

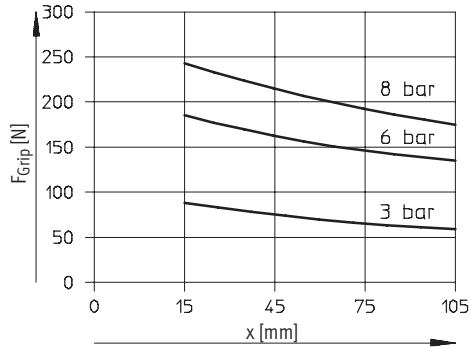

HGPL-25-80-A

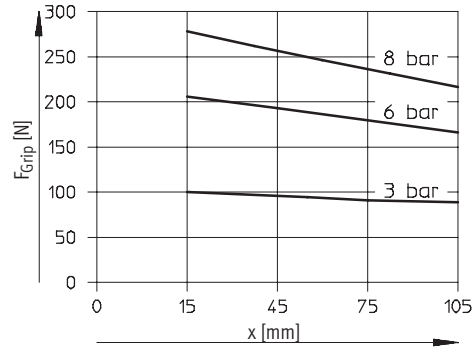

HGPL-40-40-A

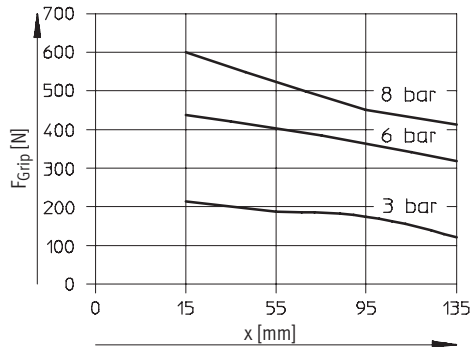

HGPL-40-80-A

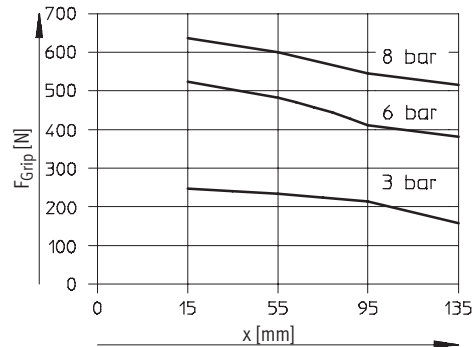

Parallel grippers HGPL, robust, with long stroke

Technical data

Gripping force F_{Grip} per gripper jaw as a function of lever arm x and eccentricity y

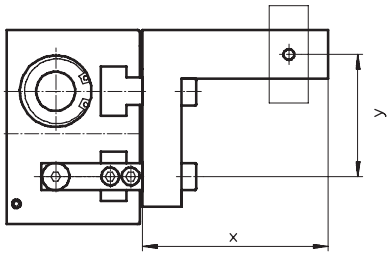

Gripping forces at 6 bar dependent upon eccentric application of force and the maximum permissible off-centre point of force application can be determined for the various sizes using the following graphs.

Calculation example

Given:

Lever arm $x = 32$ mm

Eccentricity $y = 22$ mm

To be found:

Gripping force at 6 bar

Procedure:

- Determine the intersection xy between lever arm x and eccentricity y in the graph for HGPL-14-40-A
- Draw an arc (with centre at origin) through intersection xy
- Determine the intersection between the arc and the X axis
- Read the gripping force

Result:

Gripping force = approx. 68.3 N

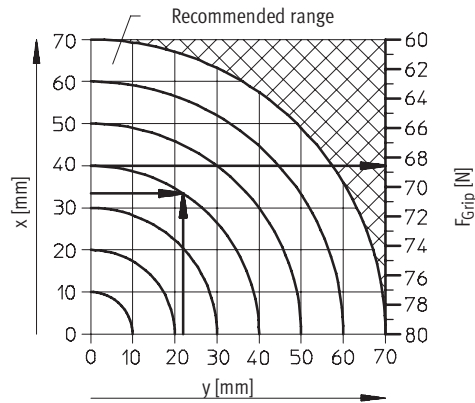

As external gripper: Closing operation

HGPL-14-40-A

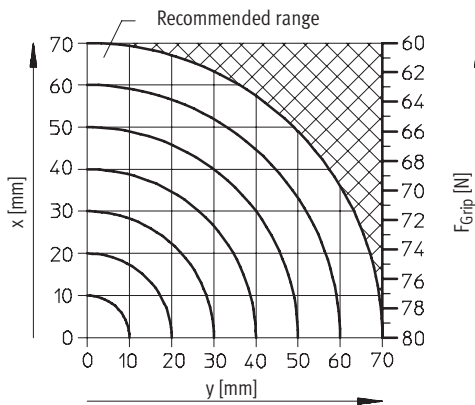

HGPL-14-80-A

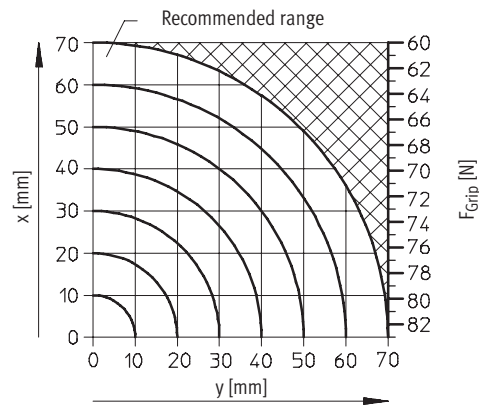

HGPL-25-40-A

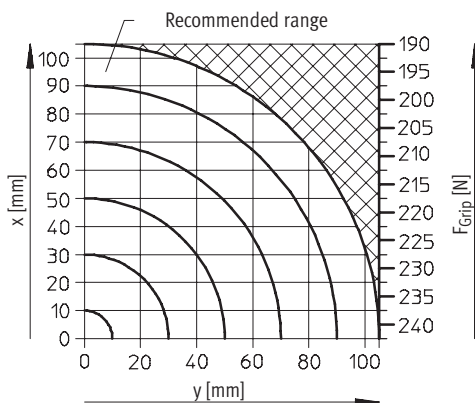

HGPL-25-80-A

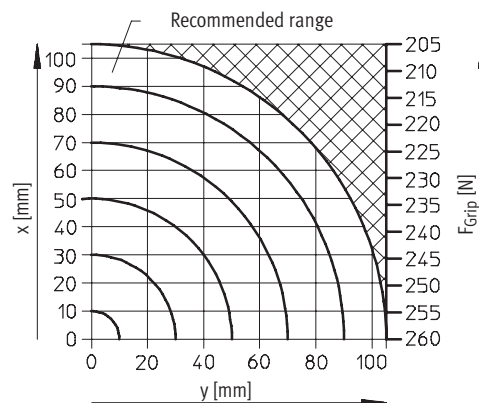

Parallel grippers HGPL, robust, with long stroke

Technical data

Gripping force F_{Grip} per gripper jaw as a function of lever arm x and eccentricity y

HGPL-40-40-A

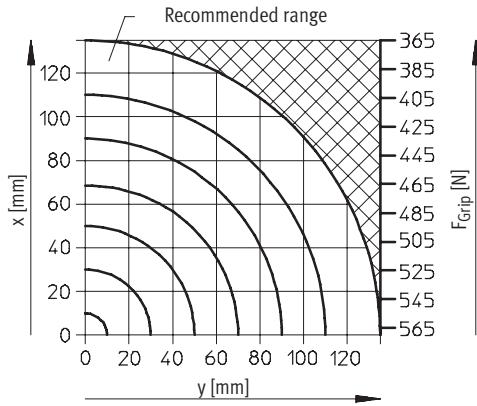

HGPL-40-80-A

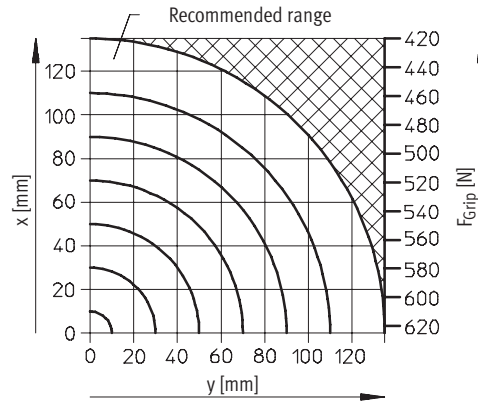

As internal gripper: Closing operation

HGPL-14-40-A

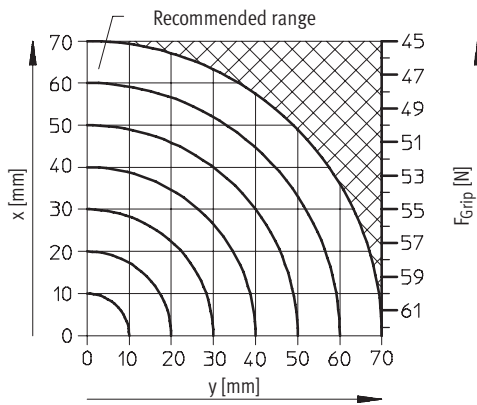

HGPL-14-80-A

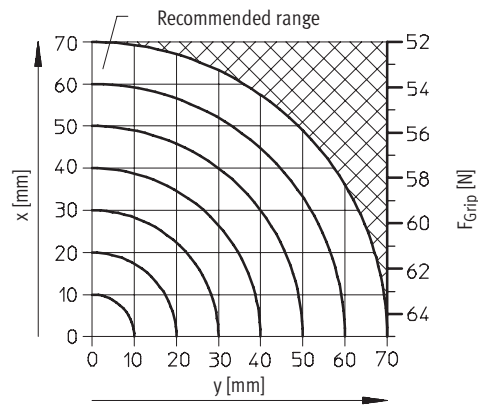

HGPL-25-40-A

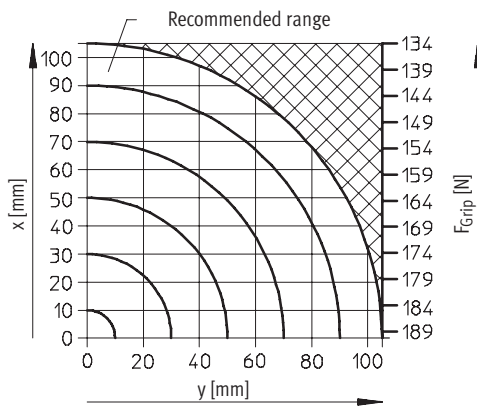

HGPL-25-80-A

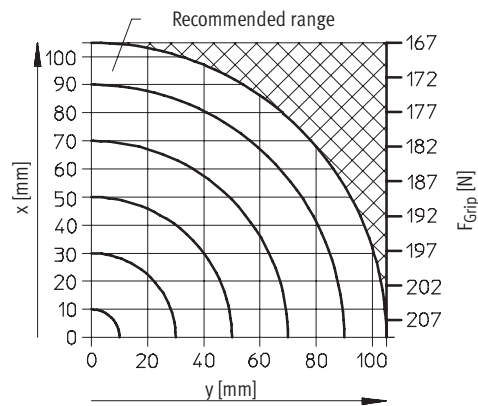

Parallel grippers HGPL, robust, with long stroke

Technical data

Gripping force F_{Grip} per gripper jaw as a function of lever arm x and eccentricity y

HGPL-40-40-A

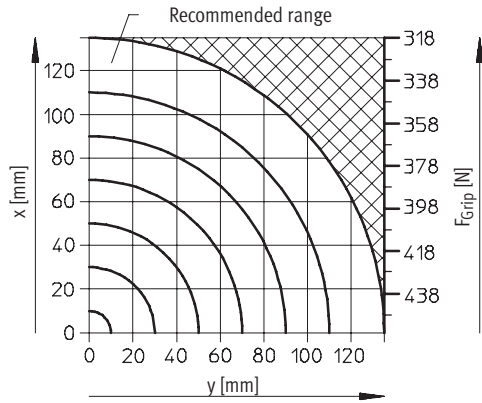

HGPL-40-80-A

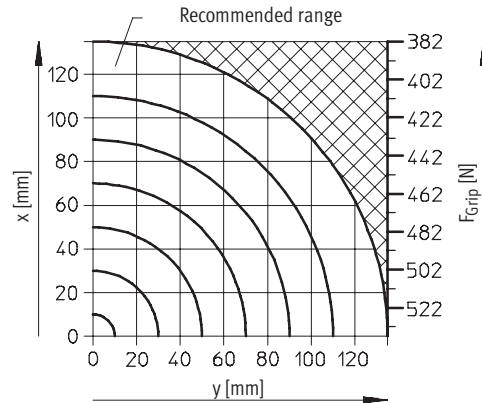

Parallel grippers HGPL, robust, with long stroke

Technical data

FESTO

Dimensions

Download CAD data → www.festo.com

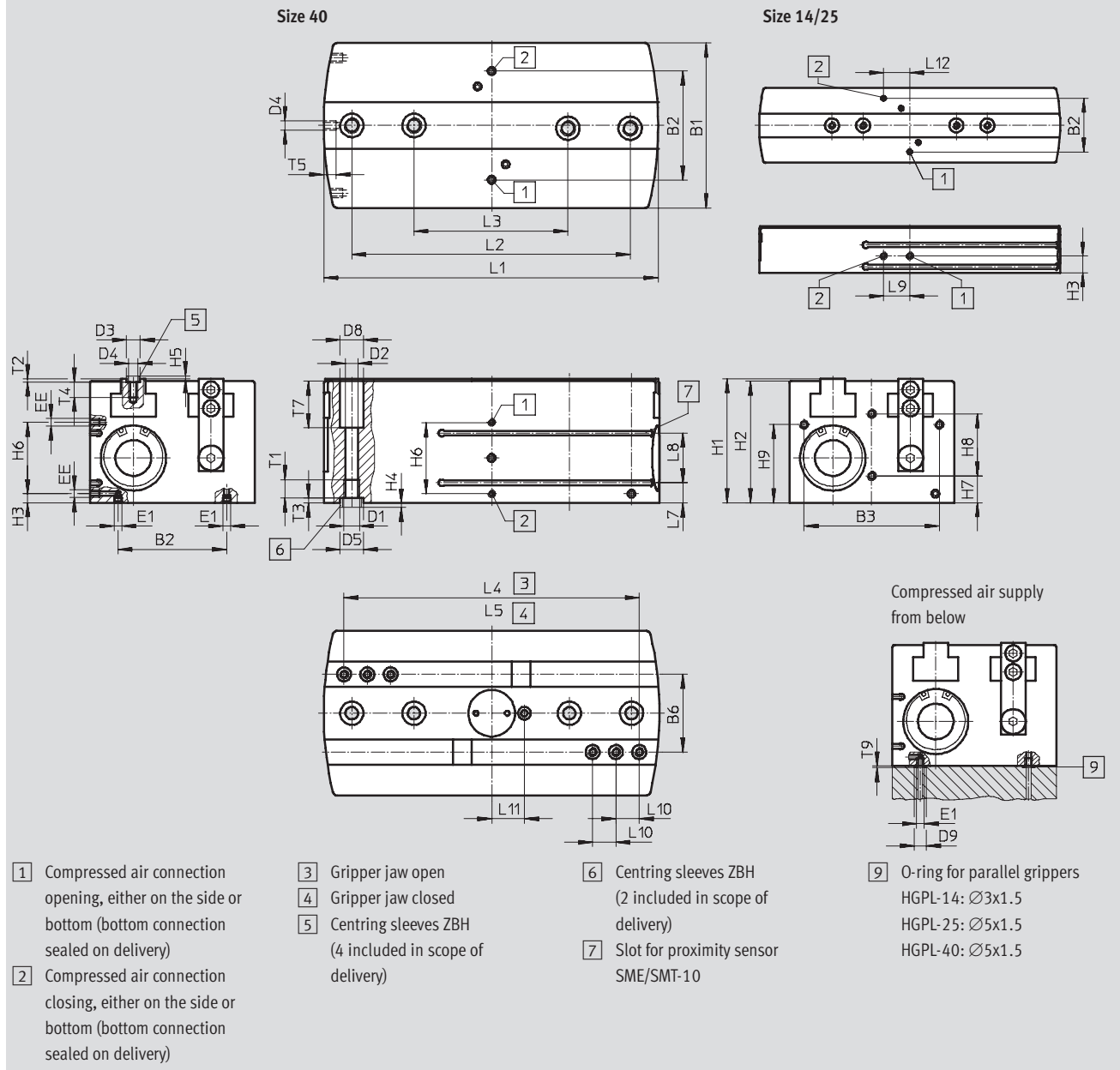

Parallel grippers HGPL, robust, with long stroke

Technical data

Type	B1 ±0.05	B2 ±0.1	B3 ±0.1	B6 ±0.01	D1	D2 ∅ +0.1	D3 ∅ H8/h7	D4	D5 ∅ H8/h7	D8 ∅ H13	D9	EE	E1
HGPL-14-40	48	34.5	37	22	M5	4.2	5	M3	9	7.4	6	M5	M3
HGPL-14-80													
HGPL-25-40	80	60	65	38	M6	5.1	7	M5	9	10	8	M5	M5
HGPL-25-80													
HGPL-40-40	106	70	87	50	M10	8.5	9	M6	15	15	8	M5	M5
HGPL-40-80													

Type	H1	H2 ±0.1	H3 ±0.1	H4 -0.3	H5 -0.3	H6 ±0.1	H7 ±0.1	H8 ±0.1	H9 ±0.1	L1 ±0.1	L2 ±0.02 ¹⁾ ±0.1 ²⁾	L3 ±0.02 ¹⁾ ±0.1 ²⁾	L4 ±0.5
HGPL-14-40	30	29	11	1.9	1.2	-	10	12	18	113.6	-	60	102
HGPL-14-80										193.6	100	60	182
HGPL-25-40	50	49	18	1.9	1.4	-	18	20	30	126	-	60	104
HGPL-25-80										206	100	60	184
HGPL-40-40	80	78.5	6	2.9	1.9	46	17.5	40	50.5	136	-	100	110
HGPL-40-80										216	180	100	190

Type	L5 ±0.5	L7 ±0.1	L8 ±0.1	L9 ±0.2	L10 ±0.02 ¹⁾ ±0.1 ²⁾	L11 ±0.5	L12 ±0.1	T1 min.	T2 +0.1	T3 +0.1	T4 min.	T5 min.	T7 +0.1	T9
HGPL-14-40	22	4	14	16.8	8	9	16.8	12	1.3	2.1	5	6	10	1
HGPL-14-80	22													
HGPL-25-40	24	11	14	20	10	17.5	20	12	1.6	2.1	8	7	17	1
HGPL-25-80	24													
HGPL-40-40	30	13	32	-	15	21	-	15	2.1	3.1	10	8	30	1
HGPL-40-80	30													

1) For centring
2) For through-hole

Parallel grippers HGPL, robust, with long stroke

Technical data

Ordering data			
Size [mm]	Stroke [mm]	Double-acting without compression spring	
		Part No.	Type
14			
	40	535 852	HGPL-14-40-A
	80	535 853	HGPL-14-80-A
25			
	40	535 854	HGPL-25-40-A
	80	535 855	HGPL-25-80-A
40			
	40	535 856	HGPL-40-40-A
	80	535 857	HGPL-40-80-A

Ordering data – Wearing parts kits			
Size [mm]	Part No. Type		
14	701 585	HGPL-14	
25	701 586	HGPL-25	
40	701 587	HGPL-40	

Parallel grippers HGPL, robust, with long stroke

Accessories

Stroke reducing plate HGPL-HR

Material:
Aluminium
Free of copper, PTFE and silicone

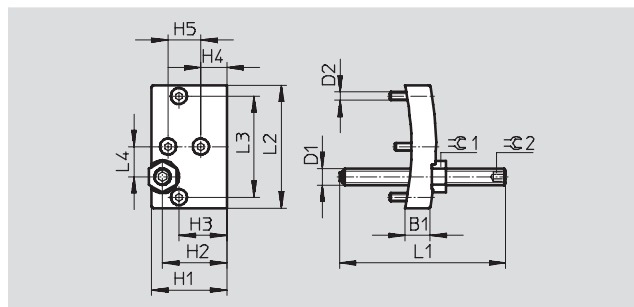

Dimensions and ordering data								
For size	B1	D1	D2	H1	H2	H3	H4	H5
[mm]	±0.1			±0.1	±0.1	±0.1	±0.1	±0.1
14	9	M6	M3	27.5	23.5	17.5	9.5	12
25	12	M8	M5	47.5	37.5	29.5	17.5	20
40	18	M12	M6	77	63	50	17	40

For size	L1	L2	L3	L4	∅C1	∅C2	Weight	Part No.	Type
[mm]	±1	±0.1	±0.1	±0.1			[g]		
14	61	45	37	11	10	3	45	539 092	HGPL-HR-14
25	61	77	65	19	13	4	150	539 093	HGPL-HR-25
40	61	103	87	25	19	6	455	539 094	HGPL-HR-40

Parallel grippers HGPL, robust, with long stroke

FESTO

Accessories

Unmachined gripper finger

BUB-HGPL

(Scope of delivery: 2 pcs.)

Material:

Aluminium

Free of copper, PTFE and silicone

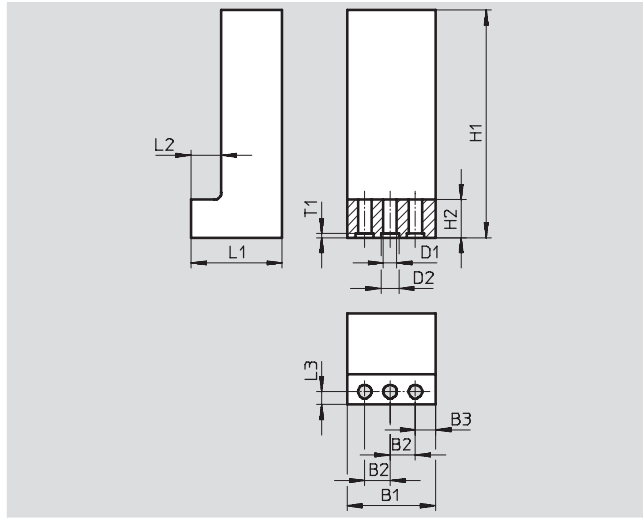

Dimensions and ordering data							
For size	B1	B2	B3	D1	D2	H1	H2
[mm]	±0.1	+0.02		+0.1	H8	±0.1	
14	25	8	4	3.2	5	80	11
25	35	10	8	5.3	7	120	15
40	50	15	10	6.4	9	150	18

For size	L1	L2	L3	T1	Weight per unmachined gripper finger [g]	Part No.	Type
[mm]	±0.1	+0.1	+0.1	+0.1			
14	20.5	8	3.3	1.3	75	537 316	BUB-HGPL-14
25	36	12	5	1.6	295	537 317	BUB-HGPL-25
40	49.5	16.5	8	2.1	720	537 318	BUB-HGPL-40



Ordering data						
	For size [mm]	Weight [g]	Part No.	Type	PU ¹⁾	
Centring sleeve for the gripper jaws ZBH Technical data → Internet: zbh						
	14	1	189 652	ZBH-5	10	
	25	1	186 717	ZBH-7	10	
	40	1	150 927	ZBH-9	10	
Centring sleeve for the gripper ZBH Technical data → Internet: zbh						
	14	1	189 652	ZBH-9	10	
	25					
	40	3	191 409	ZBH-15	10	
Blanking plug B Technical data → Internet: b						
	14 (at front)	0.6	30 979	B-M3-S9	10	
	14, 25, 40	1	174 308	B-M5-B	10	



1) Packaging unit quantity



Parallel grippers HGPL, robust, with long stroke

Accessories

FESTO

Ordering data – Proximity sensors for C-slot, magneto-resistive					Technical data → Internet: smt	
	Type of mounting	Switch output	Electrical connection, connection direction	Cable length [m]	Part No.	Type
N/O contact						
	Insertable in the slot from above, flush with cylinder profile	PNP	Cable, 3-wire, in-line	2.5	525 915	SMT-10F-PS-24V-K2,5L-OE
			Plug M8x1, 3-pin, in-line	0.3	525 916	SMT-10F-PS-24V-K0,3L-M8D
			Plug M8x1, 3-pin, lateral	0.3	526 675	SMT-10F-PS-24V-K0,3Q-M8D
	Insertable in the slot lengthwise	PNP	Plug M8x1, 3-pin, in-line	0.3	173 220	SMT-10-PS-SL-LED-24
			Cable, 3-wire, in-line	2.5	173 218	SMT-10-PS-KL-LED-24

Ordering data – Proximity sensors for C-slot, magnetic reed					Technical data → Internet: sme	
	Type of mounting	Switch output	Electrical connection, connection direction	Cable length [m]	Part No.	Type
N/O contact						
	Insertable in the slot from above, flush with cylinder profile	Contacting	Plug M8x1, 3-pin, in-line	0.3	525 914	SME-10F-DS-24V-K0,3L-M8D
			Cable, 3-wire, in-line	2.5	525 913	SME-10F-DS-24V-K2,5L-OE
			Cable, 2-wire, in-line	2.5	526 672	SME-10F-ZS-24V-K2,5L-OE
	Insertable in the slot lengthwise	Contacting	Plug M8x1, 3-pin, in-line	0.3	173 212	SME-10-SL-LED-24
			Cable, 3-wire, in-line	2.5	173 210	SME-10-KL-LED-24

Ordering data – Connecting cables				Technical data → Internet: nebu	
	Electrical connection, left	Electrical connection, right	Cable length [m]	Part No.	Type
	Straight socket, M8x1, 3-pin	Cable, open end, 3-wire	2.5	541 333	NEBU-M8G3-K-2.5-LE3
			5	541 334	NEBU-M8G3-K-5-LE3
	Angled socket, M8x1, 3-pin	Cable, open end, 3-wire	2.5	541 338	NEBU-M8W3-K-2.5-LE3
			5	541 341	NEBU-M8W3-K-5-LE3