

Spindle axes EGC-BS-KF, with recirculating ball bearing guide



Spindle axes EGC-BS-KF, with recirculating ball bearing guide

Key features

At a glance

Powerful

- Generously sized profiles with an optimised cross section afford the drives maximum rigidity and load capacity
- Speed, acceleration and torque resistance set a new standard

Economical

- In addition to the technical data, the EGC is a winner with its excellent price/performance ratio
- Due to the EGC's high performance it is often possible to use a smaller size

Versatile

- Different spindle pitches, numerous sizes and variants such as protected guides open up a broad range of applications
- Space-saving position sensing with proximity sensor in the profile slot is possible
- Wide range of options for mounting on drive units
- Comprehensive range of mounting accessories for multi-axis combinations

Broad range for the most varied load conditions

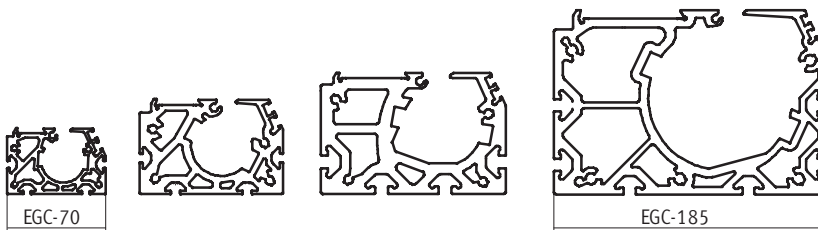

Characteristic values of the axes

The specifications shown in the table are maximum values.

The precise values for each of the variants can be found in the relevant technical data in the catalogue.

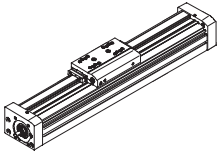
Version	Size	Working stroke [mm]	Speed [m/s]	Repetition accuracy [mm]	Feed force [N]	Guide characteristics				
						Forces and torques				
						F _y [N]	F _z [N]	M _x [Nm]	M _y [Nm]	M _z [Nm]
Recirculating ball bearing guide										
	70	50 ... 1,000	0.5	±0.02	300	1,850	1,850	16	132	132
	80	50 ... 2,000	1.0	±0.02	600	3,050	3,050	36	228	228
	120	50 ... 2,500	1.5	±0.02	1,300	6,890	6,890	144	680	680
	185	50 ... 3,000	2.0	±0.02	3,000	15,200	15,200	529	1,820	1,820

Note

Sizing software
PositioningDrives
→ www.festo.com

Spindle axes EGC-BS-KF, with recirculating ball bearing guide

Key features

Complete system comprising spindle axis, motor, motor controller and motor mounting kit
Spindle axis with recirculating ball bearing guide



Motor

→ 26



- 1 Servo motor EMMS-AS
- 2 Stepper motor EMMS-ST

 **Note**
A range of specially adapted complete solutions is available for the spindle axis EGC and the motors.

Motor controller

Technical data → Internet: motor controller



- 1 Servo motor controller CMMP-AS, CMMS-AS
- 2 Stepper motor controller EMMS-ST

Motor mounting kit

→ 26

Axial kit



- Kit comprising:
- Motor flange
 - Coupling housing
 - Coupling
 - Screws

Spindle axes EGC-BS-KF, with recirculating ball bearing guide

Peripherals overview

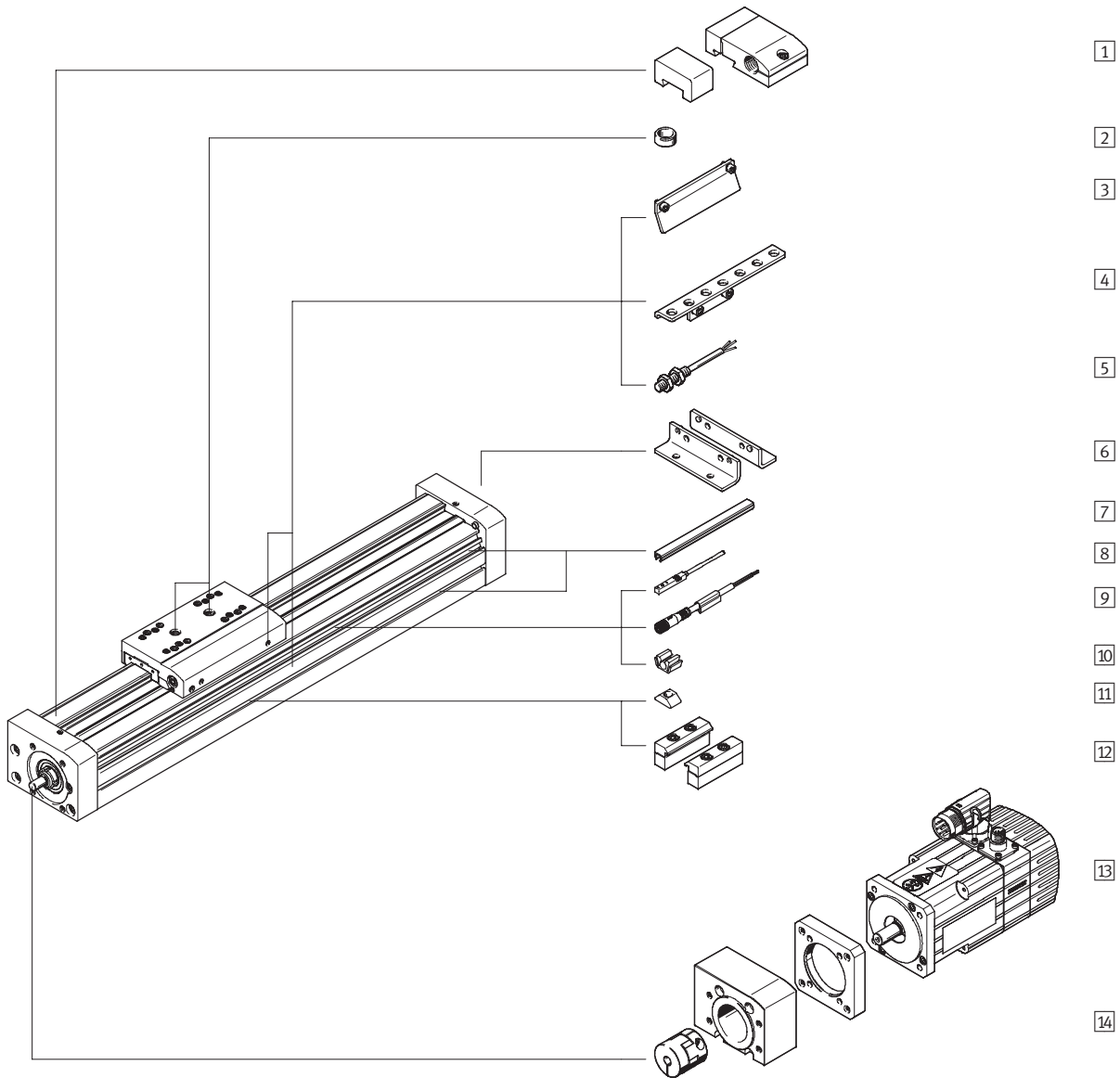

Spindle axes EGC-BS-KF, with recirculating ball bearing guide

Peripherals overview

FESTO

Variants and accessories		
Type	Brief description	→ Page/Internet
1 Emergency buffer with retainer A	For avoiding damage at the end stop in the event of malfunction	30
2 Centring pin/sleeve ZBS, ZBH	<ul style="list-style-type: none"> For centring loads and attachments on the slide 6 centring pins/sleeves included in the scope of delivery for the axis 	32
3 Switch lug X, Z, O, P, W, R	For sensing the slide position	30
4 Sensor retainer O, P, W, R	Adapter for mounting the inductive proximity sensors (round design) on the axis	31
5 Proximity sensor, M8 O, P, W, R	<ul style="list-style-type: none"> Inductive proximity sensor, round design With the order code O, P, W, R, 1 switch lug and max. 2 sensor retainers are included in the scope of delivery 	33
6 Foot mounting F	For mounting the axis on the end cap (only possible on one side)	29
7 Slot cover B, S	<ul style="list-style-type: none"> For protecting against ingress of dirt 	32
8 Proximity sensor, slot type 8 X, Z	<ul style="list-style-type: none"> Inductive proximity sensor, for slot type 8 For the order code X, Z, 1 switch lug is included in the scope of delivery 	32
9 Plug socket with cable V	For proximity sensor (order code W and R)	33
10 Clip CL	For mounting the proximity sensor cable in the slot	32
11 Slot nut Y	For mounting attachments	32
12 Profile mounting M	For mounting the axis on the profile	29
13 Motor EMMS	Motors specially matched to the axis, with or without brake	26
14 Axial kit EAMM	For axial motor mounting (comprising: clutch, clutch housing and motor flange)	26
– Passive guide axis EGC-FA	Axis without drive	egc-fa

Spindle axes EGC-BS-KF, with recirculating ball bearing guide

Type codes

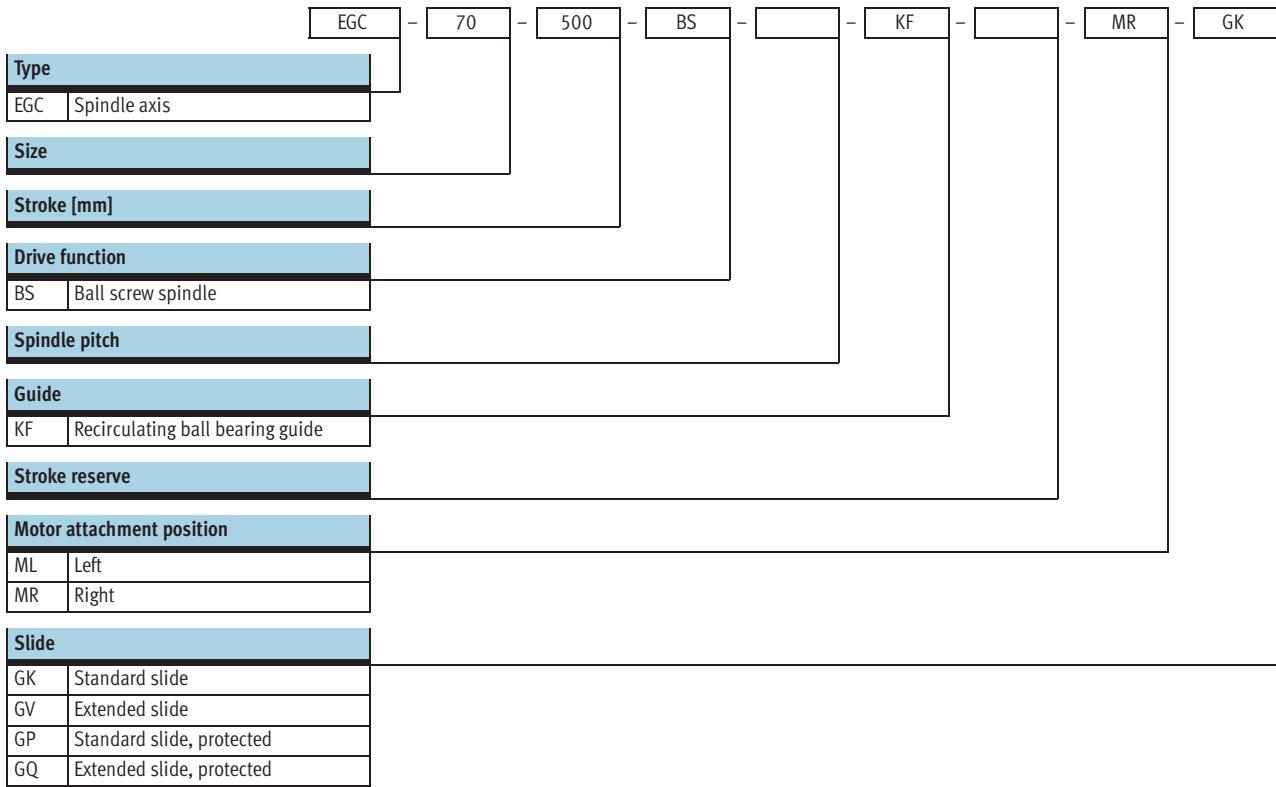

Spindle axes EGC-BS-KF, with recirculating ball bearing guide

FESTO

Type codes



→		-		-	ZUB -	-	F2MX2Z	-	DN
Additional slide									
KL	Standard, left								
Additional slide									
KR	Standard, right								
Accessories enclosed separately									
F	Foot mounting								
...M	Profile mounting								
...B	Mounting slot cover								
...S	Sensor slot cover								
...Y	Slot nut for mounting slot								
...X	Proximity sensor (SIES), inductive, slot type 8, PNP, normally open contact, cable 7.5 m								
...Z	Proximity sensor (SIES), inductive, slot type 8, PNP, normally closed contact, cable 7.5 m								
...A	Emergency buffer with retainer								
...O	Proximity sensor (SIEN), inductive, M8, PNP, normally open contact, cable 2.5 m								
...P	Proximity sensor (SIEN), inductive, M8, PNP, normally closed contact, cable 2.5 m								
...W	Proximity sensor (SIEN), inductive, M8, PNP, normally open contact, M8 plug								
...R	Proximity sensor (SIEN), inductive, M8, PNP, normally closed contact, M8 plug								
...V	Plug socket with cable								
...CL	Cable clip								
Operating instructions									
DN	No								

Spindle axes EGC-BS-KF, with recirculating ball bearing guide

Technical data

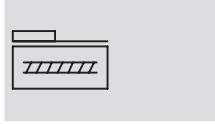
Function



-  - Size
70 ... 185
-  - Stroke length
50 ... 3,000 mm

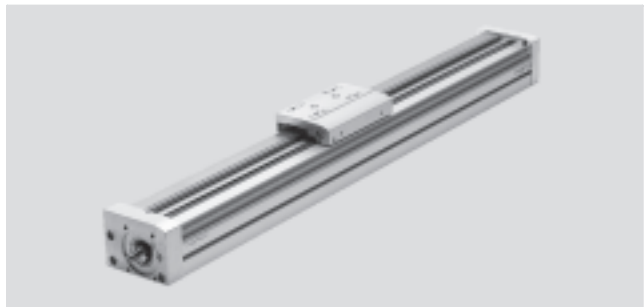

General technical data							
Size	70		80		120		185
Spindle pitch	10		10	20	10	25	40
Constructional design	Electromechanical axis with recirculating ball bearing spindle						
Guide	Recirculating ball bearing guide						
Mounting position	Any						
Working stroke	GK/GP	[mm]	50 ... 1,000	50 ... 2,000	50 ... 2,500		50 ... 3,000
	GV/GQ	[mm]	50 ... 900	50 ... 1,900	50 ... 2,400		50 ... 2,900
Max. feed force F_x	[N]	300	600		1,300		3,000
No-load torque at min. speed of travel	[Nm]	0.1	0.1	0.2	0.5	0.6	1.5
	[m/s]	0.05	0.1	0.1	0.2	0.2	0.2
No-load torque at max. speed of travel	[Nm]	0.2	0.3	0.45	1	1.4	4.3
	[m/s]	0.5	0.5	1	0.6	1.5	2
Max. radial force ¹⁾	[N]	220	250		500		4,000
Max. rotational speed ²⁾	[rpm]	3,000	3,000		3,600		3,000
Max. acceleration	[m/s ²]	15					
Repetition accuracy	[mm]	±0.02					

- 1) On the drive shaft
- 2) Rotational speed and speed are stroke-dependent

Operating and environmental conditions	
Ambient temperature	[°C] -10 ... +60
Protection class	IP40
Duty cycle	[%] 100

Weight [kg]							
Size	70		80		120		185
Basic weight with 0 mm stroke ¹⁾	GK/GP	1.5	2.7		12.5		30
	GV/GQ	2	3.5		14.4		34.5
Additional weight per 1,000 mm stroke		5	8		19		39
Moving load	GK/GP	0.4	0.74		2.4		8.6
	GV/GQ	0.6	0.95		2.9		9.85
Additional slide	KL/KR	0.3	0.55		2		6

- 1) Incl. slide

Spindle axes EGC-BS-KF, with recirculating ball bearing guide

FESTO

Technical data

Spindle							
Size		70	80	120	185		
Diameter	[mm]	12	15	25	40		
Pitch	[mm/rev.]	10	10	20	10	25	40

Mass moment of inertia							
Size		70	80	120	185		
Spindle pitch		10	10	20	10	25	40
J_0	GK [kg mm ²]	1.99	5.2	5.2	64.46	64.46	594
	GV [kg mm ²]	3.41	8.67	8.68	92	92	774.71
J_H per metre stroke	[kg mm ² /m]	1.42	3.46	3.46	27.56	27.56	180.31
J_L per kg working load	[kg mm ² /Kg]	2.53	2.53	10.13	2.53	15.83	40.53
J_W	GK [kg mm ²]	1.04	1.86	7.46	6.09	38.06	348.87
	GV [kg mm ²]	1.48	2.34	9.35	7.34	45.85	399.08

The mass moment of inertia J_A of the entire axis is calculated as follows:

$$J_A = J_0 + J_W + J_H \times \text{working stroke [m]} + J_L \times m_{\text{working load [kg]}}$$

Materials

Sectional view

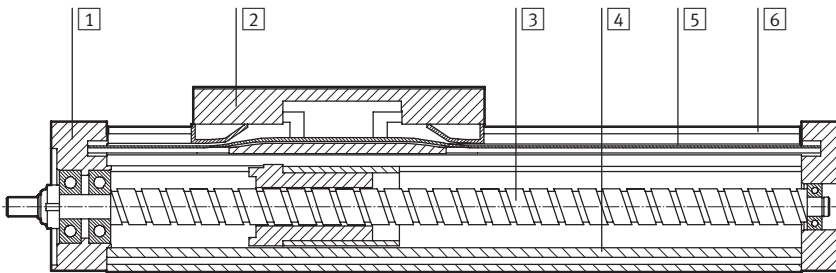

Axis		
1	End cap	Wrought aluminium alloy, anodised
2	Slide	Wrought aluminium alloy, anodised
3	Spindle	Steel
4	Profile	Anodised aluminium
5	Cover strip	Polyurethane
6	Guide rail	High-alloy steel
Note on materials		RoHS-compliant

Spindle axes EGC-BS-KF, with recirculating ball bearing guide

Technical data

Characteristic load values

The indicated forces and torques refer to the slide surface. The point of application of force is the point where the centre of the guide and the lengthwise centre of the slide intersect. They must not be exceeded during dynamic operation. Special attention must be paid to the cushioning phase.

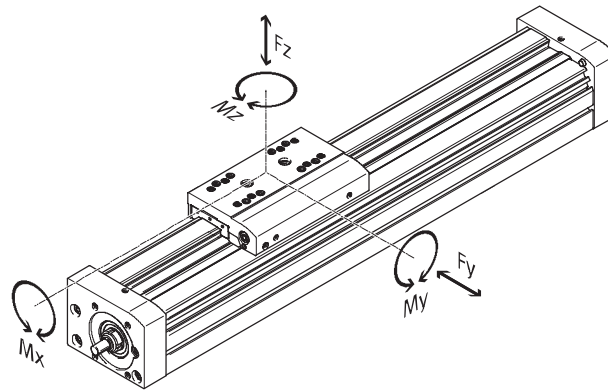

If the axis is subjected to more than two of the indicated forces and torques simultaneously, the following equation must be satisfied in addition to the indicated maximum loads:

Calculation of the guide index value:

$$f_v = \frac{|F_{y,dyn}|}{F_{y,max}} + \frac{|F_{z,dyn}|}{F_{z,max}} + \frac{|M_{x,dyn}|}{M_{x,max}} + \frac{|M_{y,dyn}|}{M_{y,max}} + \frac{|M_{z,dyn}|}{M_{z,max}}$$

Permissible forces and torques		70	80	120	185
F _{y,max.}	[N]	1,850	3,050	6,890	15,200
F _{z,max.}	[N]	1,850	3,050	6,890	15,200
M _{x,max.}	[Nm]	16	36	144	529
M _{y,max.}	GK/GP [Nm]	51	97	380	1,157
M _{z,max.}	GK/GP [Nm]	51	97	380	1,157
M _{y,max.}	GV/GQ [Nm]	132	228	680	1,820
M _{z,max.}	GV/GQ [Nm]	132	228	680	1,820

Rated loads		70	80	120	185		
Size		70	80	120	185		
Spindle pitch		10	10	20	10	25	40
Ball screw							
Dynamic C _{dyn,KGT}	[N]	4,000	6,820	7,480	16,000	13,700	36,200

Spindle axes EGC-BS-KF, with recirculating ball bearing guide

Technical data

FESTO

Service life

The service life of the guide depends on the load. In order to make an approximate assessment of the service life of the guide, the guide

index value f_v in relation to the service life is presented in the diagram below as a characteristic.

This chart only lists the theoretical value. If guide index values f_v greater than 1.5 are returned, then it is

essential that you contact your local contact person at Festo.

Guide index value f_v as a function of service life

Example:

A user wants to move a mass weighing X kg. Using the above calculation, a value of 1.5 is returned for the guide index value. According to the diagram, the guide has a service life

of approx. 1,500 km. Reducing the acceleration reduces the value M_z and M_y . Now with a guide index value of 1, the service life is 5,000 km.

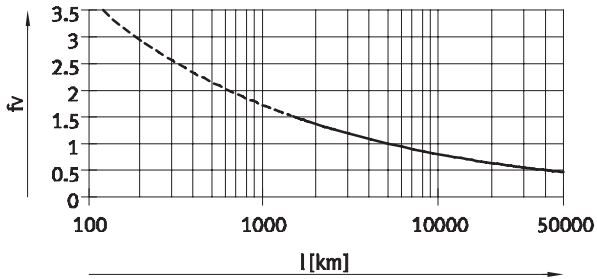

 Note
Design software
PositioningDrives
www.festo.com

The load comparison factor f_v can also be calculated using the sizing software.

f_v values > 1.5 are only theoretical comparison values for the recirculating ball bearing guide.

Spindle axes EGC-BS-KF, with recirculating ball bearing guide

Technical data

Speed v as a function of working stroke l

EGC-70/-80

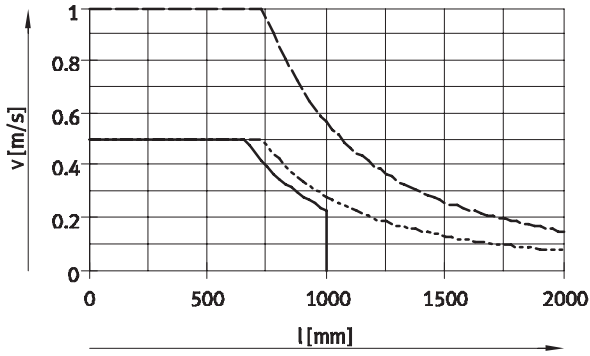

— EGC-70-10P - - - EGC-80-20P
 - · - · - EGC-80-10P

EGC-120/-185

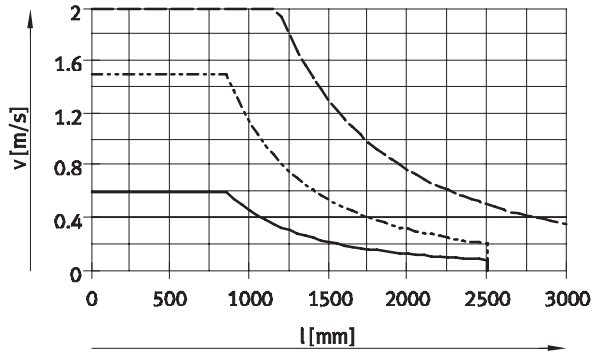

— EGC-120-10P - - - EGC-185-40P
 - · - · - EGC-120-25P - · - · - EGC-185-20P

Speed v as a function of rotational speed n

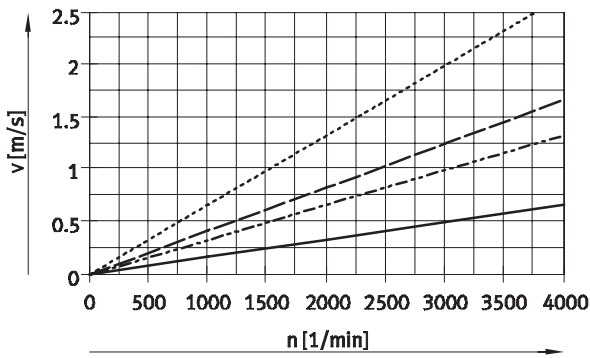

 Note
 Rotational speed is stroke-dependent.
 Note maximum rotational speed.

— EGC-70/-80-10P/-120-10P
 - - - EGC-80-20P
 - · - · - EGC-120-25P
 - · - · - EGC-185
 - · - · - EGC-185-40P

Spindle axes EGC-BS-KF, with recirculating ball bearing guide

Technical data

Maximum acceleration a as a function of applied load m

EGC-70

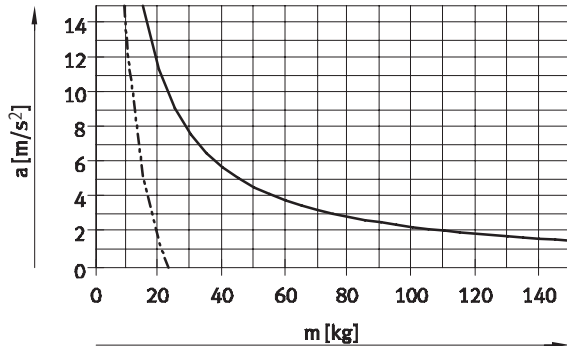

EGC-80

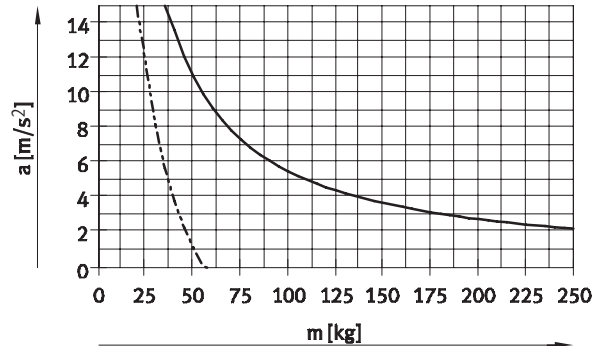

EGC-120

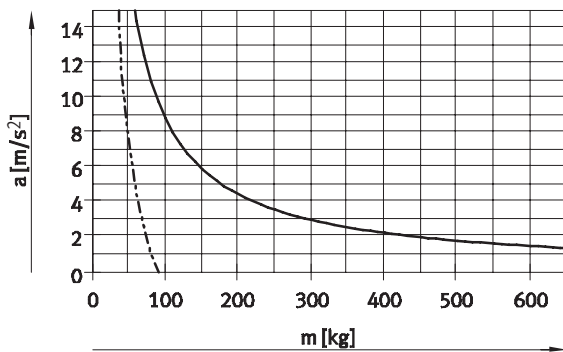

EGC-185

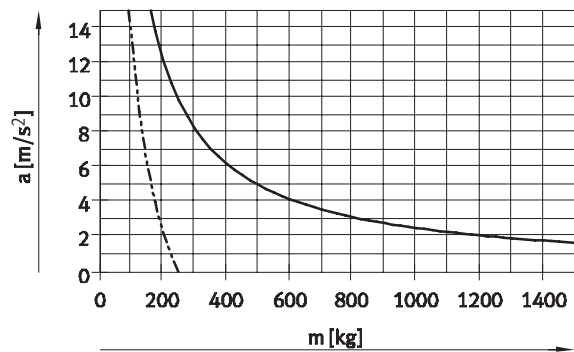

— Horizontal mounting position - - - - Vertical mounting position

Effective force F as a function of input torque M

EGC-70/-80

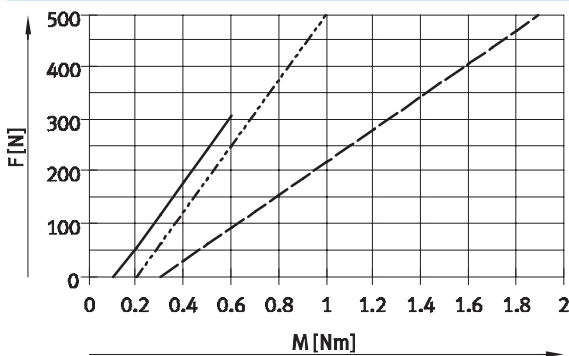

— EGC-70-10P - - - EGC-80-20P
 ····· EGC-80-10P - · - · EGC-70-20P

EGC-120/-185

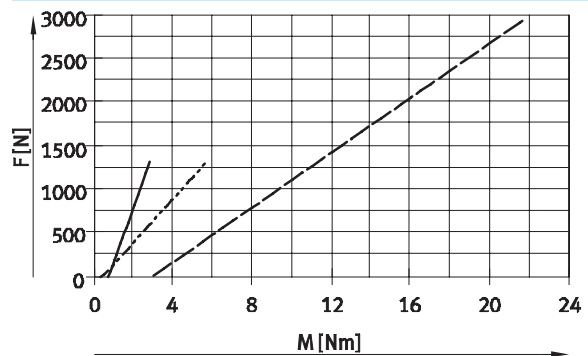

— EGC-120-BS-10P - - - EGC-185-BS-40P
 ····· EGC-120-BS-25P - · - · EGC-185-BS-10P

Spindle axes EGC-BS-KF, with recirculating ball bearing guide

Technical data

Stroke reserve

Stroke length	Stroke reserve					
The selected stroke always corresponds to the required work stroke. With the variants GK/GV there is no wiper seal on the guide. On these variants therefore there is a safety gap between the drive cover and the slide which is not intended as a work stroke.	If a safety gap (similar to GK/GV) between the drive cover and the slide is also to be defined for the variants GP/GQ, this is possible via the feature "Stroke reserve" of the modular product system. With the variants GK/GV the stroke reserve and the safety gap are added per end position.					
	<ul style="list-style-type: none"> The length of the stroke reserve can be selected as desired. The sum of the stroke length and 2x stroke reserve must not exceed the maximum work stroke. 					
	Example: EGC-70-500-BS-10P-KF-20H-... Working stroke = 500 mm 2x stroke reserve = 40 mm Total length = 540 mm (540 mm = 500 mm + 2x 20 mm)					

Size	70		80		120		185
Spindle pitch	10		10	20	10	25	40
Safety gap with GK/GV (per end position) [mm]	10.5		13	13	18	18	21

Working stroke reduction

in standard slide GK/GP / extended slide GV/GQ with additional slide KL/KR

- L16 = Slide length
- L17 = Additional slide length
- L18 = Distance between both slides
- 1 Additional slide

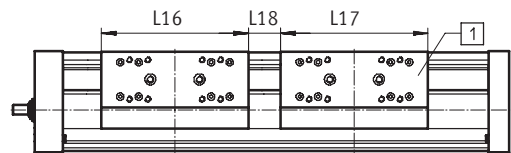

- For a spindle axis with additional slide, the working stroke is reduced by the length of the additional slide and the distance between both slides
 - When ordering the variant GP/GQ, the additional slide is also protected
 - When ordering the variant GV/GQ, the additional slide is not extended
- Example:**
 Type EGC-70-500-BS-...-GK-KR
 Working stroke without additional slide = 500 mm
 L18 = 20 mm
 L16, L17 = 100 mm
 Working stroke with additional slide = 380 mm
 (500 mm - 20 mm - 100 mm)

Dimensions – Additional slide

Size	70		80		120		185
	GK/GV	GP/GQ	GK/GV	GP/GQ	GK/GV	GP/GQ	GK/GV
Length L17 [mm]	100	121	120	146	200	236	280
Min. distance between the slides L18 [mm]	-	21	-	26	-	36	-

Working stroke reduction per side

with integrated emergency buffer NPE and shock absorber retainer KYE

Where a spindle axis is used, the working stroke is reduced by the total dimension of the emergency buffer and shock absorber retainer. The rubber buffer in the lid must be removed.

Size	70		80		120		185
With emergency buffer [mm]	43		68		98		133

Spindle axes EGC-BS-KF, with recirculating ball bearing guide

Technical data

2nd moment of area

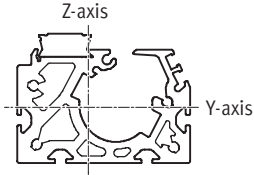

Size		70	80	120	185
I_y	[mm ⁴]	4.19×10^5	9.81×10^5	5.01×10^6	2.61×10^7
I_z	[mm ⁴]	5.78×10^5	1.32×10^6	5.82×10^6	2.6×10^7

Maximum permissible support span L (without profile mounting) as a function of force F

In order to limit deflection in the case of large strokes, the axis may need to be supported.

The following diagrams help to determine the maximum permissible support span L as a function of force F acting on the axis. The deflection is $f = 0.5$ mm.

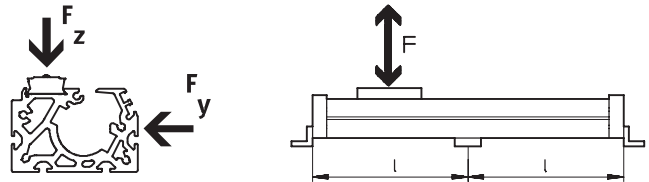

Force Fy

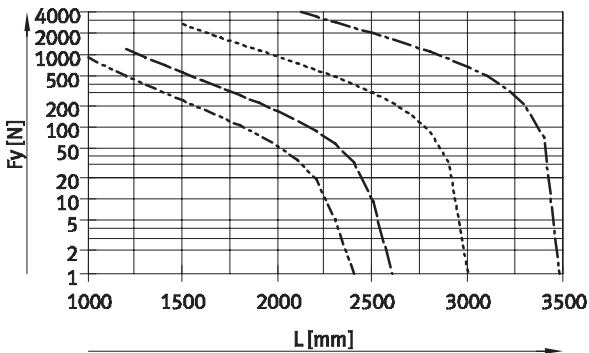

Force Fz

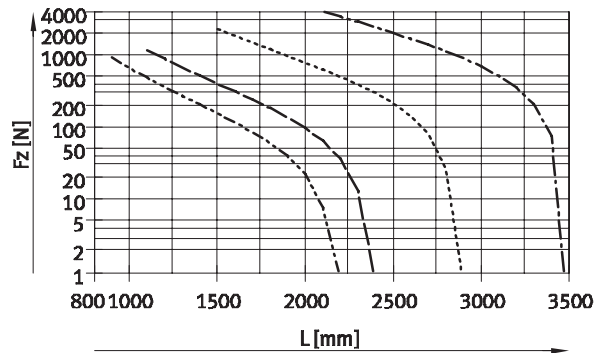

- EGC-70
- EGC-80
- EGC-120
- EGC-185

Recommended deflection limit values

To ensure that the performance of the axes is not impaired, adherence to the following deflection limit values is recommended.

Higher deformations can lead to increased friction, greater wear and a reduced service life.

Size	Dyn. deflection (load is moving)	Stat. deflection (load at standstill)
70 ... 185	0.05% of the length of the axis, max. 0.5 mm	0.1% of the length of the axis

Spindle axes EGC-BS-KF, with recirculating ball bearing guide

Technical data

Dimensions

Download CAD data → www.festo.com

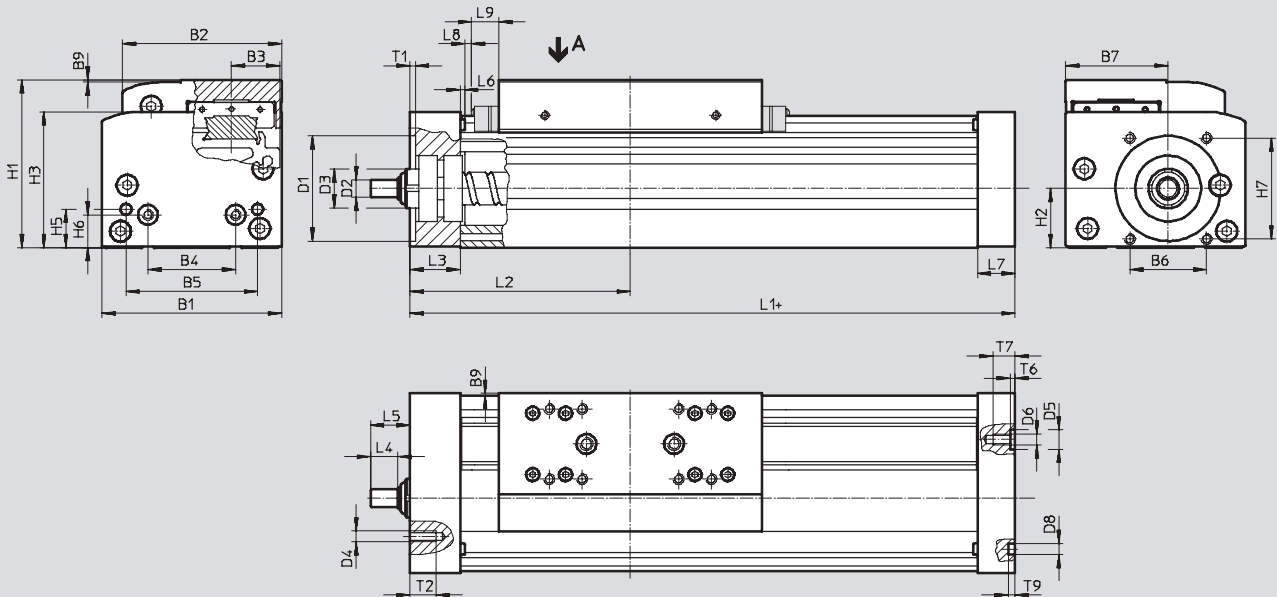

+ = plus stroke length + 2x stroke reserve
 L9 For GK/GV safety distance per end position
 For GP/GQ size for scraper → 14

Profile

Size 70

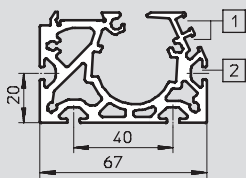

Size 80

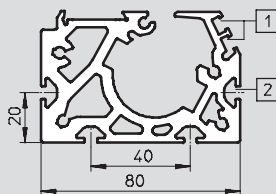

Size 120

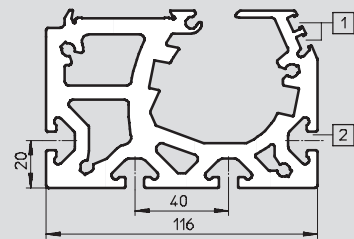

Size 185

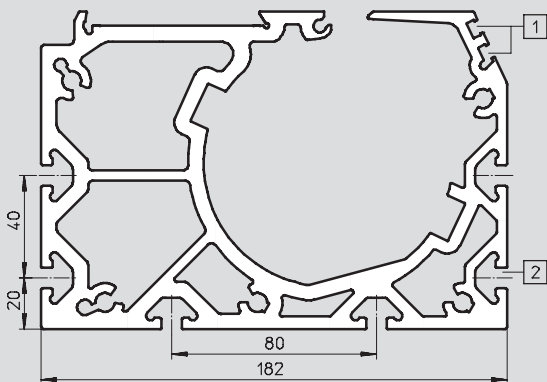

1 Sensor slot for proximity sensor
 2 Mounting slot for slot nut

 Note

To avoid distortions in the slide, the bearing surfaces of the attachments must maintain a flatness of at least 0.01 mm.

Spindle axes EGC-BS-KF, with recirculating ball bearing guide

Technical data

FESTO

Size	Variant	Stroke	B1	B2	B3	B4	B5	B6	B7	B9	D1 ∅ H7	D2 ∅ h7	D3
70	GK/GP	50 ... 1,000	69	58.6	16.5	30	45	29	39	1	38	6	≈13
	GV/GQ	50 ... 900											
80	GK/GP	< 1,477	82	72.6	22	40	60	35	46.75	1	48	8	∅18
		> 1,477											
	GV/GQ	< 1,377											
		> 1,377											
120	GK/GP	< 1,704	120	107	33	80	40	64	78	1	62	12	∅28
		> 1,704											
	GV/GQ	< 1,604											
		> 1,604											
185	GK/GP	< 2,361	186	169	53	120	80	80	114	1	95	25	∅44
		> 2,361											
	GV/GQ	< 2,261											
		> 2,261											

Size	Variant	Stroke	D4	D5 ∅ H7	D6	D8 ∅ H7	H1	H2	H3	H5	H6	H7	L1	L2
70	GK/GP	50 ... 1,000	M5	-	M5	5	64	22.5	50.5	13	13	36	168	86.5
	GV/GQ	50 ... 900											268	136.5
80	GK/GP	< 1,477	M5	9	M5	5	76.5	27	62	17.5	15	46	196	101
		> 1,477											236	121
	GV/GQ	< 1,377											296	151
		> 1,377											336	171
120	GK/GP	< 1,704	M6	-	M8	9	111.5	42.5	89.5	22	22	54	309	156
		> 1,704											369	186
	GV/GQ	< 1,604											409	206
		> 1,604											469	236
185	GK/GP	< 2,361	M8	-	M10	9	172.5	65.2	141.5	25	25	80	412	209
		> 2,361											512	259
	GV/GQ	< 2,261											512	259
		> 2,261											612	309

Size	Variant	Stroke	L3	L4	L5	L6	L7	L8	L9	T1	T2	T6	T7	T9
70	GK/GP	50 ... 1,000	21	8	14	1.8	16	3	10.5	2.5	12	-	10	3.1
	GV/GQ	50 ... 900												
80	GK/GP	< 1,477	23	12.5	18	2	17	3	13	2.5	12	2.1	10	3.1
		> 1,477												
	GV/GQ	< 1,377												
		> 1,377												
120	GK/GP	< 1,704	33	17.5	25.5	2	30	3	18	3	12	-	16	2.1
		> 1,704												
	GV/GQ	< 1,604												
		> 1,604												
185	GK/GP	< 2,361	43	23	30.5	2	37	3	21	3	20	-	20	2.1
		> 2,361												
	GV/GQ	< 2,261												
		> 2,261												

Spindle axes EGC-BS-KF, with recirculating ball bearing guide

Technical data

Dimensions

Download CAD data → www.festo.com

GK – Standard slide / GP – Standard slide, protected

Size 70

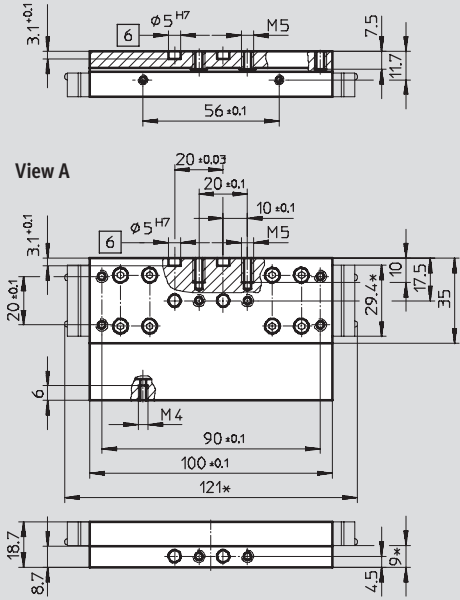

Size 80

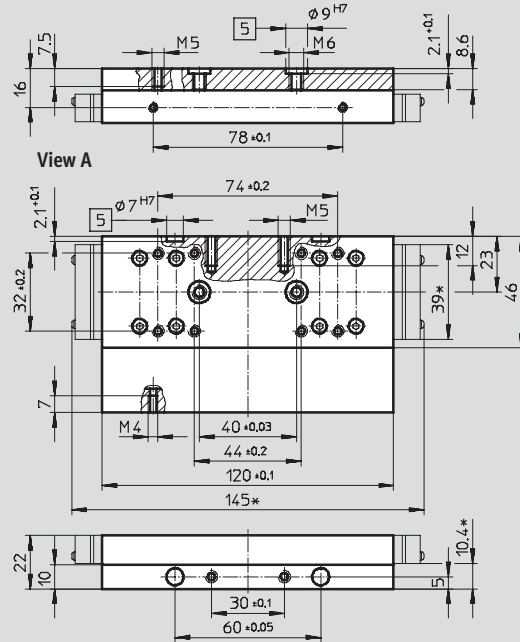

Size 120

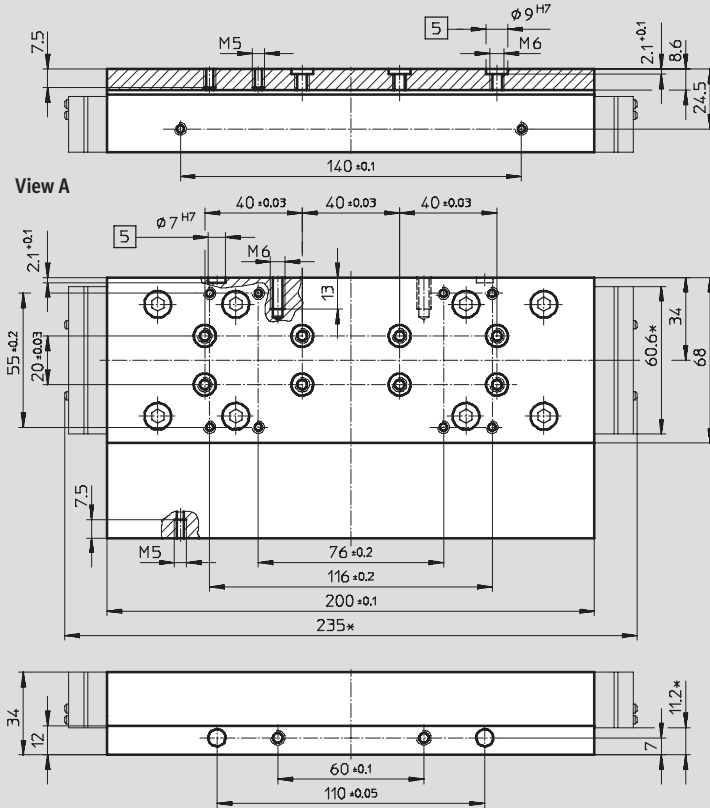

- 5 Hole for centring sleeve
- 6 Hole for centring pin
- * protected version

Spindle axes EGC-BS-KF, with recirculating ball bearing guide

Technical data

FESTO

Dimensions

Download CAD data → www.festo.com

GK – Standard slide

Size 185

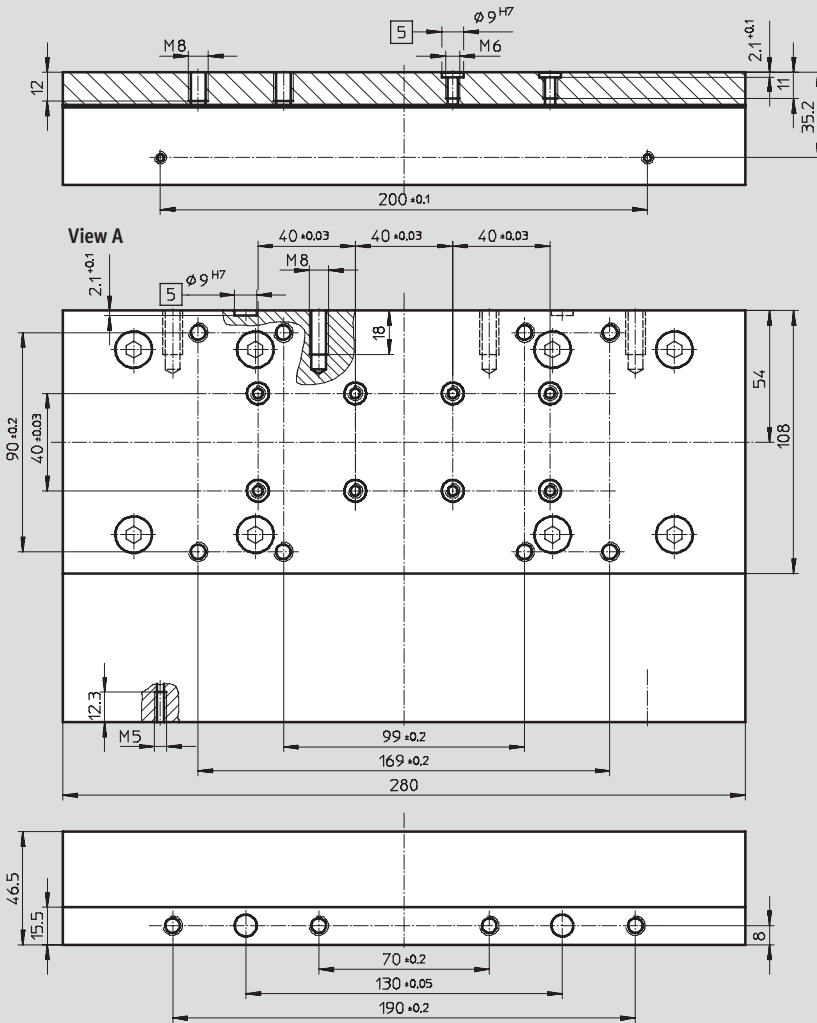

5 Hole for centring sleeve

Spindle axes EGC-BS-KF, with recirculating ball bearing guide

Technical data

Dimensions

Download CAD data → www.festo.com

GV – Extended slide / GQ – Extended slide, protected

Size 120

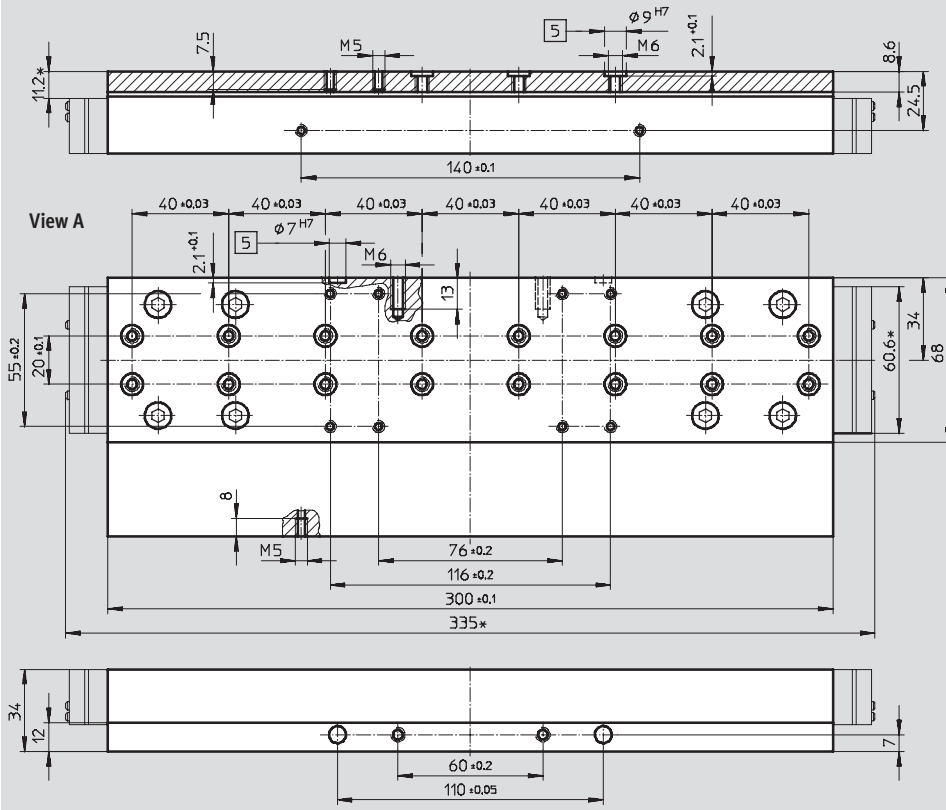

5 Hole for centring sleeve
* protected version

Spindle axes EGC-BS-KF, with recirculating ball bearing guide

Technical data

Dimensions

Download CAD data → www.festo.com

GV – Extended slide

Size 185

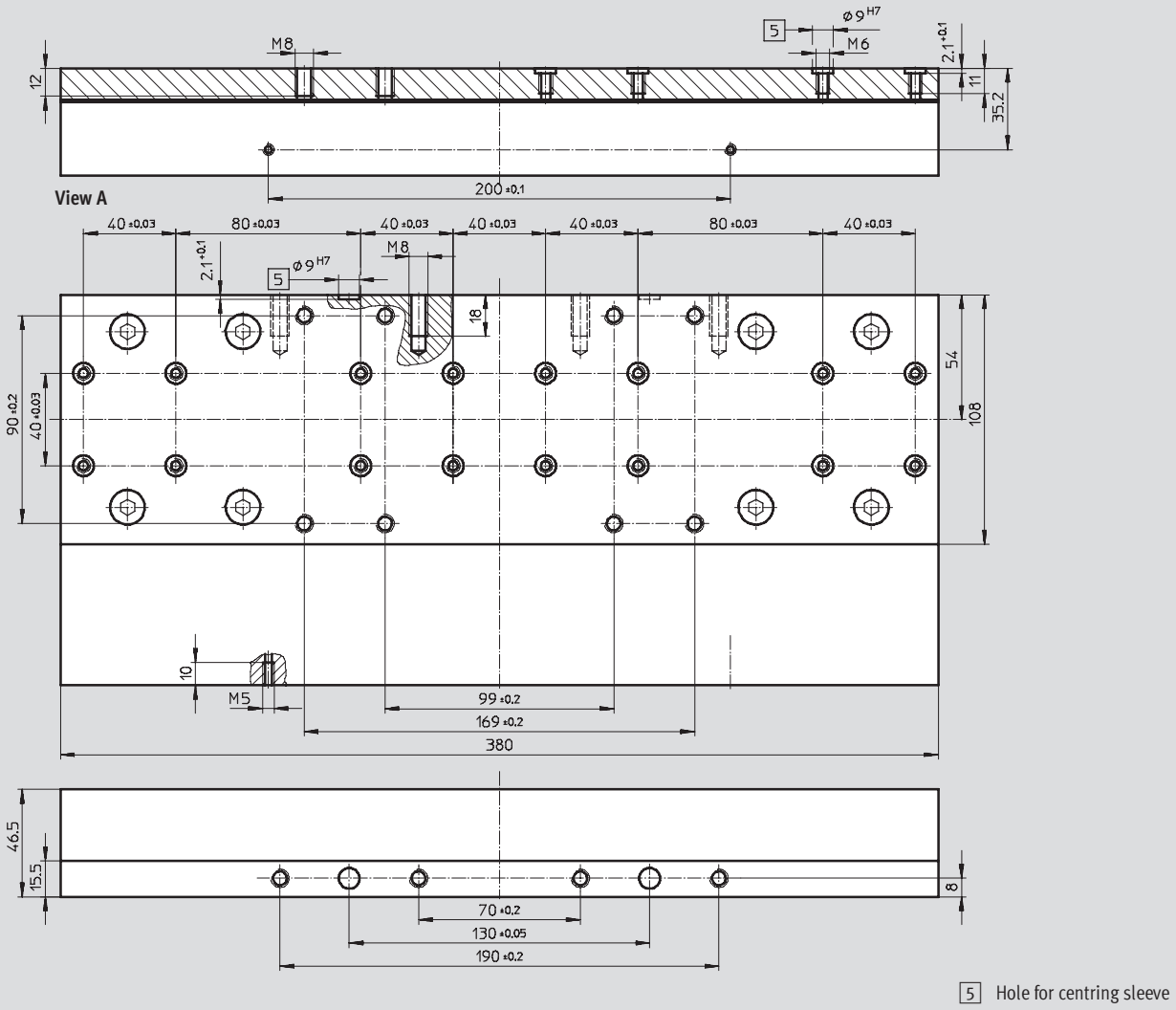

Spindle axes EGC-BS-KF, with recirculating ball bearing guide

Ordering data – Modular products

Order code

Mandatory data

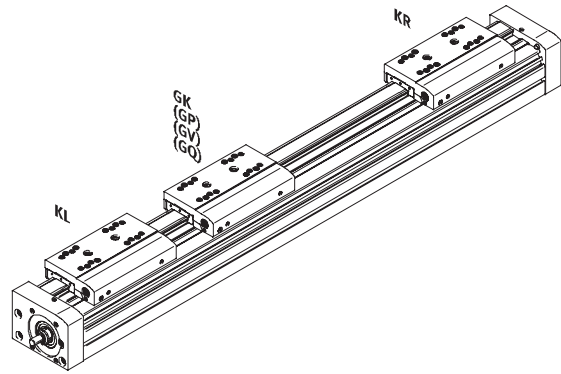
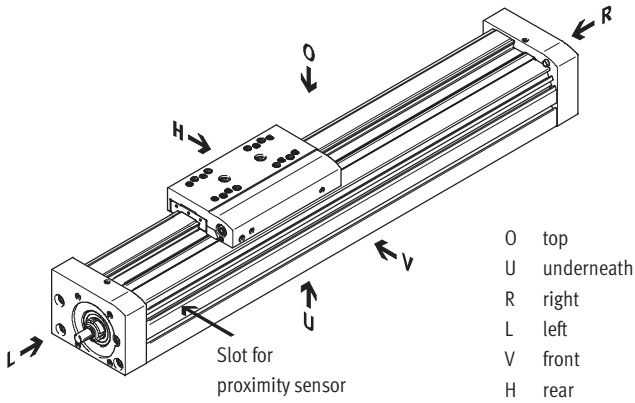

- O top
- U underneath
- R right
- L left
- V front
- H rear

Accessories

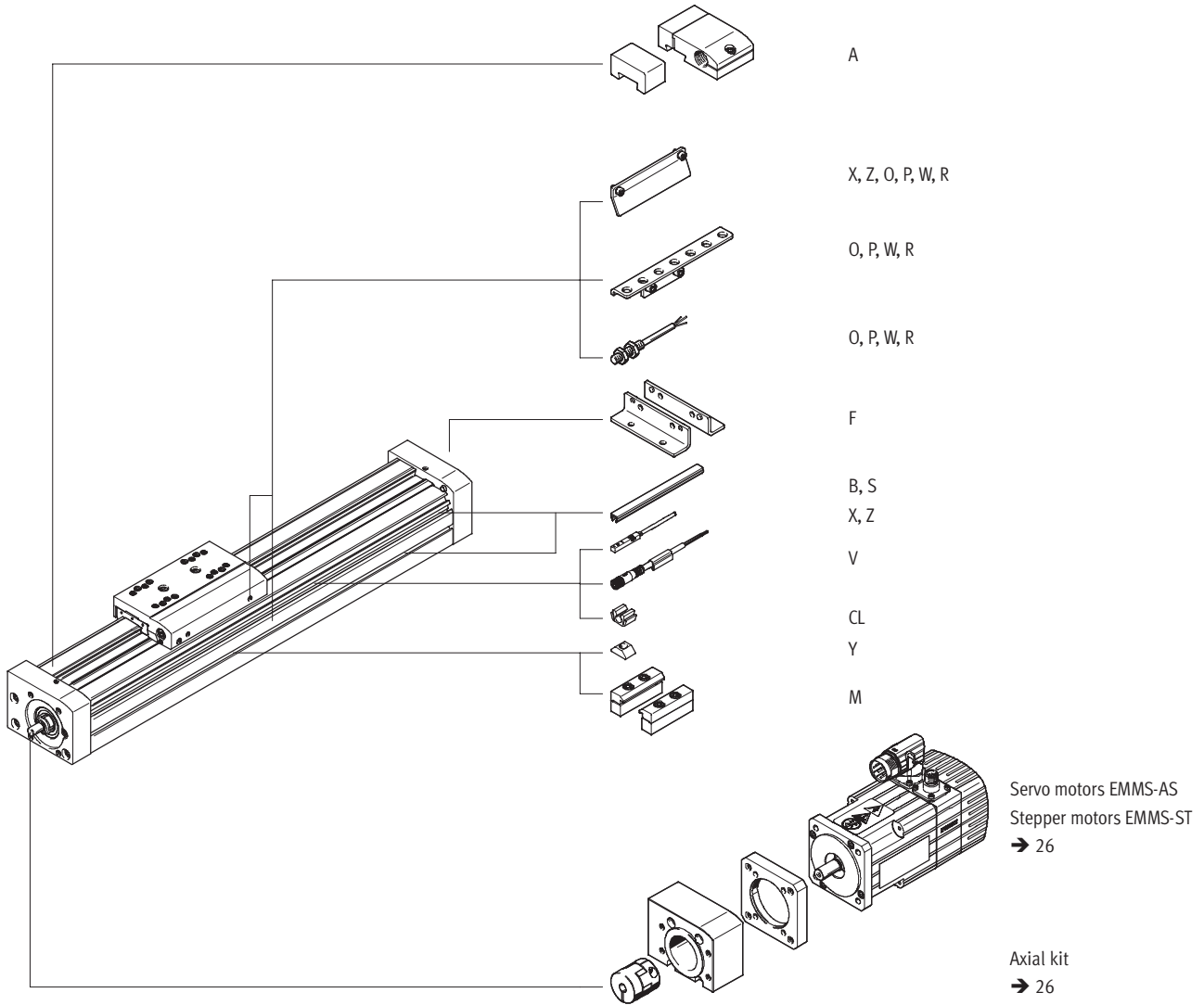

Spindle axes EGC-BS-KF, with recirculating ball bearing guide

Ordering data – Modular products

Ordering table							
Size	70	80	120	185	Condi- tions	Code	Enter code
M Module No.	556807	556808	556809	556811			
Design	Linear axis					EGC	EGC
Size	70	80	120	185		-...	-...
Stroke for GK, GP [mm] (without stroke reserve)	100, 200, 300, 400, 500, 600, 700, 800, 1,000	100, 200, 300, 500, 600, 800, 1,000, 1,400, 1,500, 1,800, 2,000	200, 300, 500, 600, 800, 1,000, 1,400, 1,500, 2,000, 2,500	300, 500, 600, 1,000, 1,500, 2,000, 2,500, 3,000		-...	-...
Stroke for GV, GQ [mm] (without stroke reserve)	100, 200, 300, 400, 500, 600, 700, 900	100, 200, 400, 500, 700, 900, 1,300, 1,400, 1,700, 1,900	100, 200, 400, 500, 700, 900, 1,300, 1,400, 1,900, 2,400	200, 400, 500, 900, 1400, 1,900, 2,400, 2,900		-...	-...
Function	Ball screw spindle					-BS	-BS
Spindle pitch	10	10	10	-		-10P	
	-	20	-	-		-20P	
	-	-	25	-		-25P	
	-	-	-	40		-40P	
Guide	Recirculating ball bearing guide					-KF	-KF
Stroke reserve [mm]	0 ... 999 (0 = no stroke reserve)				¹	-...H	
Motor attachment position	Motor left					-ML	
	Motor right					-MR	
Slide	Standard slide					-GK	
	Extended slide, protected				-	-GQ	
	Standard slide, protected				-	-GP	
	Elongated slide					-GV	
O Additional slide	Left	Additional slide, standard, at left			²	-KL	
↓	Right	Additional slide, standard, at right			²	-KR	

- ¹ -... The sum of the stroke length and 2x stroke reserve must not exceed the maximum stroke length
- ² **KL, KR** If the slide was chosen as a protected variant (GQ, GP), the additional slide (KL, KR) is also protected
If the slide was chosen as an extended variant (GQ, GV), the additional slide (KL, KR) is not extended

Order code

EGC - - - - **BS** - - **KF** - - - -

Spindle axes EGC-BS-KF, with recirculating ball bearing guide

Ordering data – Modular products

Ordering table		70	80	120	185	Condi- tions	Code	Enter code	
Size									
↓ Accessories	Accessories enclosed separately							ZUB-	ZUB-
0 Foot mounting		1					F		
Profile mounting		1 ... 50					...M		
Cover	Mounting slot	1 ... 50 (1 = 2 units 500 mm long)					...B		
	Sensor slot	1 ... 50 (1 = 2 units 500 mm long)					...S		
Slot nut for mounting slot		1 ... 99					...Y		
Proximity sensor (SIES) inductive, slot 8, PNP, incl. switch lug	Normally open contact, cable 7.5 m	1 ... 6					...X		
	Normally closed contact, cable length 7.5 m	1 ... 6					...Z		
Emergency buffer with retainer		1 ... 2				³	...A		
Proximity sensor (SIEN) inductive, M8, PNP, incl. switch lug with sensor retainer	Normally open contact, cable 2.5 m	1 ... 99					...O		
	Normally closed contact, cable length 2.5 m	1 ... 99					...P		
	Normally open contact, M8 plug	1 ... 99					...W		
	Normally closed contact, plug M8	1 ... 99					...R		
Plug socket with cable 2.5 m, M8, 3-wire		1 ... 99					...V		
Cable clip		10, 20, 30, 40, 50, 60, 70, 80, 90					...CL		
Operating instructions	Express waiver – no user documentation to be included (already available) (operating instructions in PDF format are available free of charge on the Internet www.festo.com)						-DN		

³ ... A Emergency buffer with retainer A cannot be combined with slides GP, GQ

 Note

With code X, Z, one switch lug is included in the scope of delivery.
With code O, P, W, R, one switch lug and max. two sensor retainers are included in the scope of delivery.

Transfer order code

ZUB - -

Spindle axes EGC-BS-KF, with recirculating ball bearing guide

Accessories

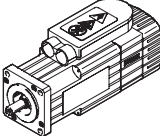
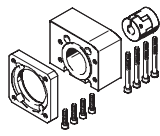
Permissible axis/motor combinations with axial kit		
Motor	Axial kit	
		
Type	Part No.	Type
EGC-70		
with servo motor		
EMMS-AS-40-M-...	558162	EAMM-A-S38-40A
EMMS-AS-55-S-...	558163	EAMM-A-S38-55A
with stepper motor		
EMMS-ST-42-S-...	560685	EAMM-A-S38-42A
EMMS-ST-57-S-...	560686	EAMM-A-S38-57A
EGC-80		
with servo motor		
EMMS-AS-55-S-...	558164	EAMM-A-S48-55A
EMMS-AS-70-S-...	558165	EAMM-A-S48-70A
with stepper motor		
EMMS-ST-57-S-...	560687	EAMM-A-S48-57A
EMMS-ST-87-S-... ¹⁾²⁾	560688	EAMM-A-S48-87A
EMMS-ST-87-M-... ²⁾		
EGC-120		
with servo motor		
EMMS-AS-70-M-...	558166	EAMM-A-S62-70A
EMMS-AS-100-S-...	558167	EAMM-A-S62-100A
EMMS-AS-140-S-...	558168	EAMM-A-S62-140A
with stepper motor		
EMMS-ST-87-S-... ¹⁾	560689	EAMM-A-S62-87A
EMMS-ST-87-M-... ³⁾		
EMMS-ST-87-L-... ³⁾		
EGC-185		
with servo motor		
EMMS-AS-100-M-...	558169	EAMM-A-S95-100A
EMMS-AS-140-M-...	558170	EAMM-A-S95-140A





1) In combination with spindle pitch 10
 2) In combination with spindle pitch 20
 3) In combination with spindle pitch 25

 **Note**
 For the optimum selection of axis/motor combinations → Sizing software PositioningDrives www.festo.com

Spindle axes EGC-BS-KF, with recirculating ball bearing guide

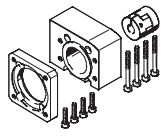
FESTO

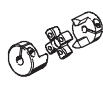
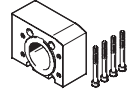
Accessories

Individual components of the axial kit				
Axial kit	Axial kit comprising:			
	Motor flange	Coupling	Coupling housing	Screws
				
Part No. Type	Part No. Type	Part No. Type	Part No. Type	Part No. Type
EGC-70				
558162 EAMM-A-S38-40A	558175 EAMF-A-38B-40A	558312 EAMC-30-32-6-6	558171 EAMK-A-S38-38A/B	–
558163 EAMM-A-S38-55A	558176 EAMF-A-38A-55A	551003 EAMC-30-32-6-9	558171 EAMK-A-S38-38A/B	567488 EAHM-L2-M5-50
560685 EAMM-A-S38-42A	560691 EAMF-A-38B-42A	561333 EAMC-30-32-5-6	558171 EAMK-A-S38-38A/B	–
560686 EAMM-A-S38-57A	560692 EAMF-A-38A-57A	551002 EAMC-30-32-6-6.35	558171 EAMK-A-S38-38A/B	567488 EAHM-L2-M5-50
EGC-80				
558164 EAMM-A-S48-55A	558177 EAMF-A-48B-55A	543423 EAMC-30-32-8-9	558172 EAMK-A-S48-48A/B	–
558165 EAMM-A-S48-70A	558025 EAMF-A-48A-70A	551004 EAMC-30-32-8-11	558172 EAMK-A-S48-48A/B	567488 EAHM-L2-M5-50
560687 EAMM-A-S48-57A	560694 EAMF-A-48B-57A	543421 EAMC-30-32-6.35-8	558172 EAMK-A-S48-48A/B	–
560688 EAMM-A-S48-87A	560695 EAMF-A-48A-87A	551004 EAMC-30-32-8-11	558172 EAMK-A-S48-48A/B	567489 EAHM-L2-M5-55
EGC-120				
558166 EAMM-A-S62-70A	558179 EAMF-A-62B-70A	558313 EAMC-42-66-11-12	558173 EAMK-A-S62-62A/B	–
558167 EAMM-A-S62-100A	558026 EAMF-A-62A-100A	551005 EAMC-42-50-12-19	558173 EAMK-A-S62-62A/B	567494 EAHM-L2-M6-80
558168 EAMM-A-S62-140A	558022 EAMF-A-62A-140A	558314 EAMC-42-50-12-24	558173 EAMK-A-S62-62A/B	567495 EAHM-L2-M6-90
560689 EAMM-A-S62-87A	560696 EAMF-A-62B-87A	558313 EAMC-42-66-11-12	558173 EAMK-A-S62-62A/B	–
EGC-185				
558169 EAMM-A-S95-100A	558182 EAMF-A-95B-100A	558315 EAMC-56-58-19-25	558174 EAMK-A-S95-95A/B	–
558170 EAMM-A-S95-140A	558023 EAMF-A-95A-140A	558316 EAMC-56-58-24-25	558174 EAMK-A-S95-95A/B	567498 EAHM-L2-M8-100

Spindle axes EGC-BS-KF, with recirculating ball bearing guide

Accessories

Axial kit EAMM-A-...

Material:

Coupling housing, coupling hubs,

motor flange: Aluminium

Screws: Steel

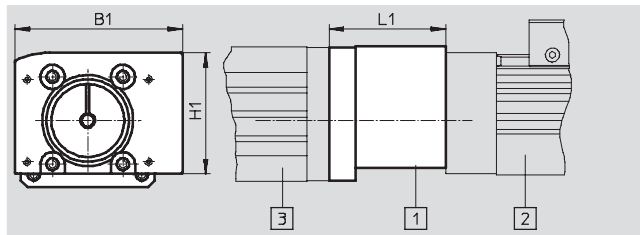

Diagram:

- 1 Axial kit
- 2 Spindle axis
- 3 Motor

General technical data									
EAMM-A-...		S38-				S48-			
		40A	42A	55A	57A	55A	57A	70A	87A
Transferable torque	[Nm]	6.5	3.5	6.5	6.5	12.5	6.5	12.5	12.5
Mass moment of inertia	[kgmm ²]	5.87	5.88	5.87	5.87	5.87	5.87	5.87	5.87
Max. rotational speed	[rpm]	8,000	8,000	8,000	8,000	8,000	8,000	8,000	8,000
Mounting position		Any							

EAMM-A-...		S62-				S95-	
		70A	87A	100A	140A	100A	140A
Transferable torque	[Nm]	17	17	17	17	60	60
Mass moment of inertia	[kgmm ²]	45.5	45.5	34.8	34.1	128	127
Max. rotational speed	[rpm]	6,000	6,000	6,000	6,000	5,500	5,500
Mounting position		Any					

Operating and environmental conditions		
Ambient temperature	[°C]	-10 ... +60
Storage temperature	[°C]	-25 ... +60
Protection class ¹⁾		IP40
Relative air humidity	[%]	0 ... 95

1) Only with combined attachment of motor and axis

Dimensions and ordering data						
Type	B1	H1	L1	Weight [g]	Part No.	Type
EAMM-A-S38-40A	69	50	44	370	558162	EAMM-A-S38-40A
EAMM-A-S38-42A			52	412	560685	EAMM-A-S38-42A
EAMM-A-S38-55A			48	400	558163	EAMM-A-S38-55A
EAMM-A-S38-57A			48	400	560686	EAMM-A-S38-57A
EAMM-A-S48-55A	82	61.5	47.2	590	558164	EAMM-A-S48-55A
EAMM-A-S48-57A			47.2	580	560687	EAMM-A-S48-57A
EAMM-A-S48-70A			50.2	610	558165	EAMM-A-S48-70A
EAMM-A-S48-87A			54	760	560688	EAMM-A-S48-87A
EAMM-A-S62-70A	120	88.5	78.5	1,950	558166	EAMM-A-S62-70A
EAMM-A-S62-87A			81.5	2,070	560689	EAMM-A-S62-87A
EAMM-A-S62-100A			81	2,050	558167	EAMM-A-S62-100A
EAMM-A-S62-140A			91	2,870	558168	EAMM-A-S62-140A
EAMM-A-S95-100A	186	140.5	85.5	4,910	558169	EAMM-A-S95-100A
EAMM-A-S95-140A			95.5	5,500	558170	EAMM-A-S95-140A

Spindle axes EGC-BS-KF, with recirculating ball bearing guide

Accessories

Foot mounting HPE
 (order code F)

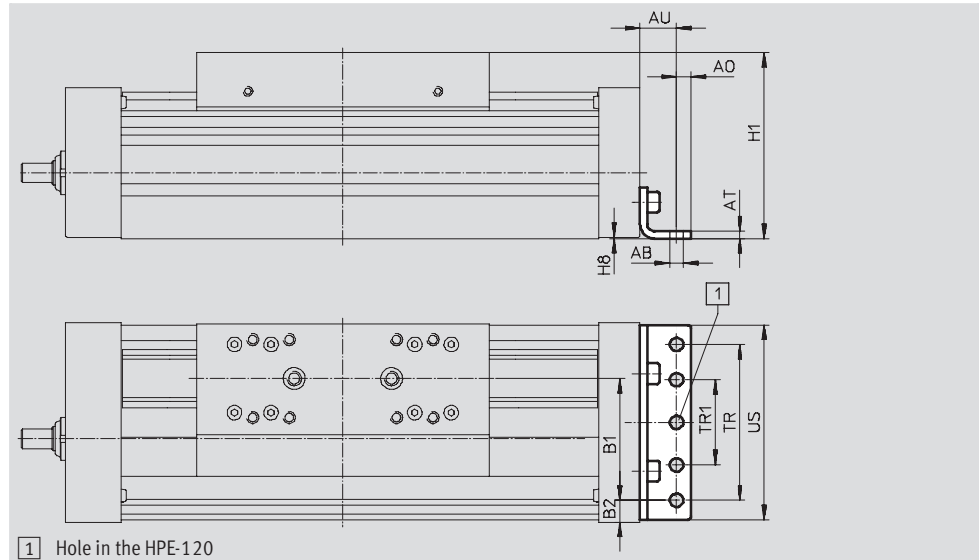
 Material:
 Galvanised steel
 RoHS-compliant

Dimensions and ordering data

For size	AB ∅	A0	AT	AU	B1	B2	H1	H8	TR	TR1	US	Weight [g]	Part No.	Type
70	5.5	6	3	13	37	14.5	64	0.5	40	–	67	115	558321	HPE-70
80	5.5	6	3	15	38	21	76.5	0.5	40	–	80	150	558322	HPE-80
120	9	8	6	22	65	20	111.5	0.6	80	–	116	578	558323	HPE-120
185	9	12	8	25	118	13	172.5	0.5	160	80	182	1,438	558325	HPE-185

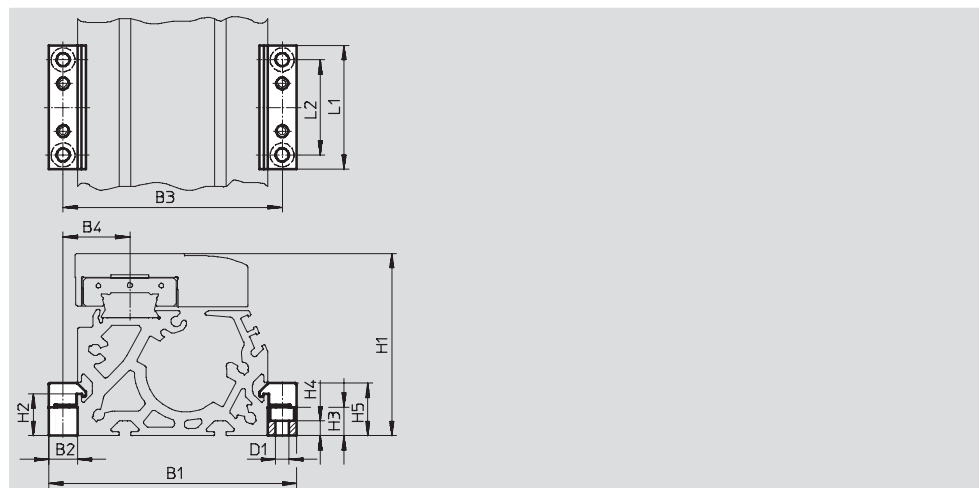
Profile mounting MUE
 (order code M)

 Material:
 Anodised aluminium
 RoHS-compliant

Dimensions and ordering data

For size	B1	B2	B3	B4	D1 ∅	H1	H2	H3	H4	H5	L1	L2	Weight [g]	Part No.	Type
70	91	12	79	22.5	5.5	64	17.5	12	6.2	22	52	40	80	558043	MUE-70/80
80	104	12	92	28	5.5	76.5	17.5	12	6.2	22	52	40	80	558043	MUE-70/80
120	154	19	135	42.5	9	111.5	16	14	5.5	29.5	90	40	290	558044	MUE-120/185
185	220	19	201	62.5	9	172.5	16	14	5.5	29.5	90	40	290	558044	MUE-120/185

Spindle axes EGC-BS-KF, with recirculating ball bearing guide

Accessories

Shock absorber retainer KYE
Emergency buffer NPE → 32
(order code A)

Material:
Anodised aluminium
RoHS-compliant

Cannot be used in combination with
the variants GP and GQ.

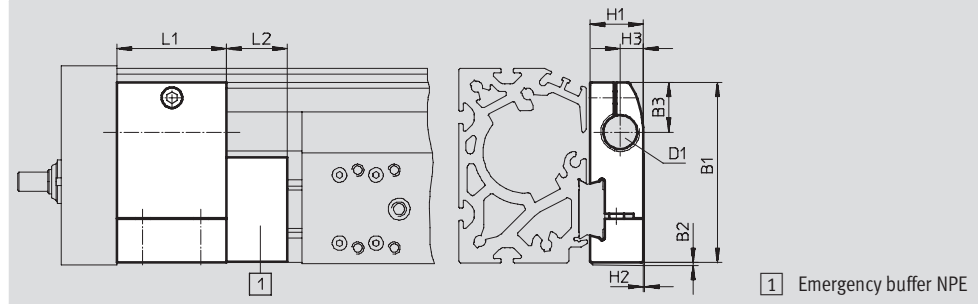

Dimensions and ordering data												
For size	B1	B2	B3	D1	H1	H2	H3	L1	L2	Weight [g]	Part No.	Type
70	57.5	1	16.5	M12X1	18.2	0.5	7.5	30	15	75	557584	KYE-70
80	74.2	1	20.5	M16X1	22	0.5	9.5	45	25	170	557585	KYE-80
120	108.5	1	26	M22X1.5	31	1	14	60	40	680	557586	KYE-120
185	168	1	37	M26X1.5	42	4	18	75	60	1,075	557587	KYE-185

Switch lug SF-EGC-1
For sensing with proximity sensor
SIES-8M
(order code X or Z)

Material:
Galvanised steel
RoHS-compliant

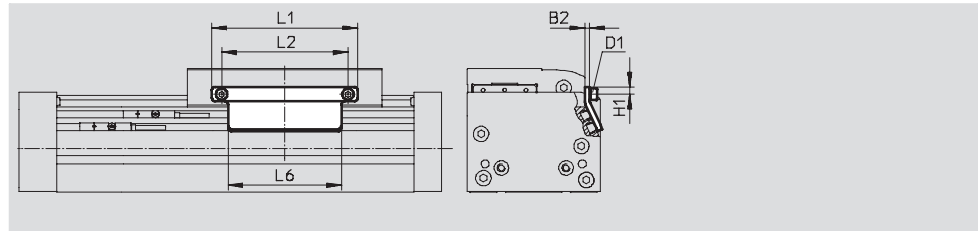

Dimensions and ordering data									
For size	B2	D1	H1	L1	L2	L6	Weight [g]	Part No.	Type
70	3	M4	4.65	70	56	50	50	558047	SF-EGC-1-70
80	3	M4	4.65	90	78	70	60	558048	SF-EGC-1-80
120	3	M5	8	170	140	170	150	558049	SF-EGC-1-120
185	3	M5	10	230	200	230	245	558051	SF-EGC-1-185

Spindle axes EGC-BS-KF, with recirculating ball bearing guide

Accessories

FESTO

Switch lug SF-EGC-2

For sensing with proximity sensor SIEN-M8B (order code O, P, W or R) or SIES-8M (order code X or Z)

Material:

Galvanised steel
RoHS-compliant

Sensor retainer HWS-EGC

For proximity sensor SIEN-M8B (order code O, P, W or R)

Material:

Galvanised steel
RoHS-compliant

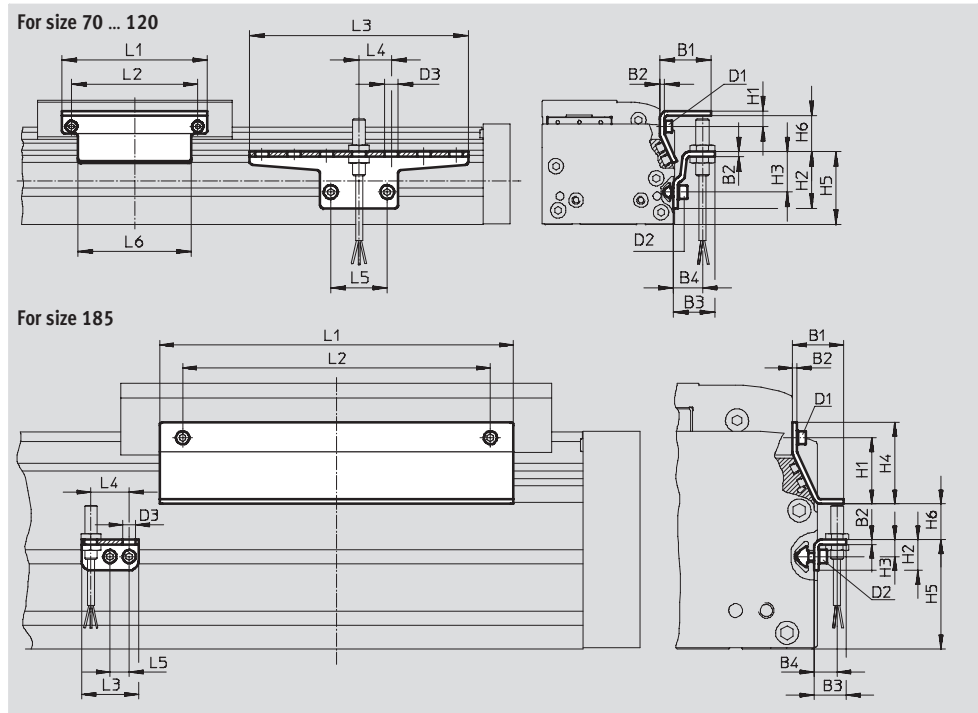

Dimensions and ordering data									
For size	B1	B2	B3	B4	D1	D2	D3	H1	H2
70	31.5	3	25.5	18	M4	M5	8.4	9.5	35
80	31.5	3	25.5	18	M4	M5	8.4	9.5	35
120	32	3	25.5	18	M5	M5	8.4	13.2	65
185	33	3	25.5	15	M5	M5	8.4	43	20





For size	H3	H4	H5	H6 max.	L1	L2	L3	L4	L5	L6
70	25	–	45	13.5	70	56	135	20	35	50
80	25	–	45	23.5	90	78	135	20	35	70
120	55	–	75	24	170	140	215	20	35	170
185	11	53	71	25.5	230	200	37	25	12.5	230

For size	Weight [g]	Part No.	Type
Switch lug			
70	100	558052	SF-EGC-2-70
80	130	558053	SF-EGC-2-80
120	280	558054	SF-EGC-2-120
185	390	558056	SF-EGC-2-185

For size	Weight [g]	Part No.	Type
Sensor retainer			
70	110	558057	HWS-EGC-M5
80	110	558057	HWS-EGC-M5
120	200	558058	HWS-EGC-M8
185	60	560517	HWS-EGC-M8:KURZ

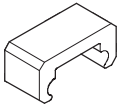
Spindle axes EGC-BS-KF, with recirculating ball bearing guide

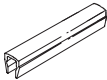
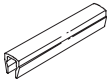
Accessories

Ordering data						
	For size	Remarks	Order code	Part No.	Type	PU ¹⁾
Emergency buffer NPE						
	70	Use in combination with shock absorber retainer KYE	A	562581	NPE-70	1
	80			562582	NPE-80	
	120			562583	NPE-120	
	185			562584	NPE-185	
Slot nut NST						
	70, 80	For mounting slot	Y	150914	NST-5-M5	1
	120, 185			150915	NST-8-M6	1
Centring pin/sleeve ZBS/ZBH²⁾						
	70	For slide	-	150928	ZBS-5	10
	80, 120, 185			150927	ZBH-9	10
Slot cover ABP						
	70, 80	For mounting slot every 0.5 m	B	151681	ABP-5	2
	120, 185			151682	ABP-8	
Slot cover ABP-S						
	70 ... 185	For sensor slot every 0.5 m	S	563360	ABP-5-S1	2
Clip SMBK						
	70 ... 185	For sensor slot, for mounting the proximity sensor cable	CL	534254	SMBK-8	1



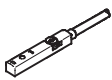
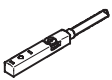





- 1) Packaging unit quantity
- 2) 6 centring pins/sleeves included in the scope of delivery for the axis



Ordering data – Proximity sensors for T-slot, inductive						Technical data → Internet: sies
	Type of mounting	Switching output	Electrical connection	Cable length [m]	Part No.	Type
N/O contact						
	Insertable in the slot from above, flush with the cylinder profile	PNP	Cable, 3-wire	7.5	551386	SIES-8M-PS-24V-K-7,5-OE
			Plug M8x1, 3-pin	0.3	551387	SIES-8M-PS-24V-K-0,3-M8D
		NPN	Cable, 3-wire	7.5	551396	SIES-8M-NS-24V-K-7,5-OE
			Plug M8x1, 3-pin	0.3	551397	SIES-8M-NS-24V-K-0,3-M8D
N/C contact						
	Insertable in the slot from above, flush with the cylinder profile	PNP	Cable, 3-wire	7.5	551391	SIES-8M-PO-24V-K-7,5-OE
			Plug M8x1, 3-pin	0.3	551392	SIES-8M-PO-24V-K-0,3-M8D
		NPN	Cable, 3-wire	7.5	551401	SIES-8M-NO-24V-K-7,5-OE
			Plug M8x1, 3-pin	0.3	551402	SIES-8M-NO-24V-K-0,3-M8D

Spindle axes EGC-BS-KF, with recirculating ball bearing guide

Accessories

FESTO

Ordering data – Inductive proximity sensors M8						Technical data → Internet: sien	
	Electrical connection		Switching output	LED	Cable length [m]	Part No.	Type
	Cable	Plug M8					
N/O contact							
	3-wire	–	PNP		2.5	150386	SIEN-M8B-PS-K-L
	–	3-pin	PNP				150387
N/C contact							
	3-wire	–	PNP		2.5	150390	SIEN-M8B-PO-K-L
	–	3-pin	PNP				150391

Ordering data – Connecting cables				Technical data → Internet: nebu	
	Electrical connection, left	Electrical connection, right	Cable length [m]	Part No.	Type
	Straight socket, M8x1, 3-pin	Cable, open end, 3-wire	2.5	159420	SIM-M8-3GD-2,5-PU
			2.5	541333	NEBU-M8G3-K-2.5-LE3
			5	541334	NEBU-M8G3-K-5-LE3
	Angled socket, M8x1, 3-pin	Cable, open end, 3-wire	2.5	541338	NEBU-M8W3-K-2.5-LE3
			5	541341	NEBU-M8W3-K-5-LE3