

Mini guided cylinders DFC

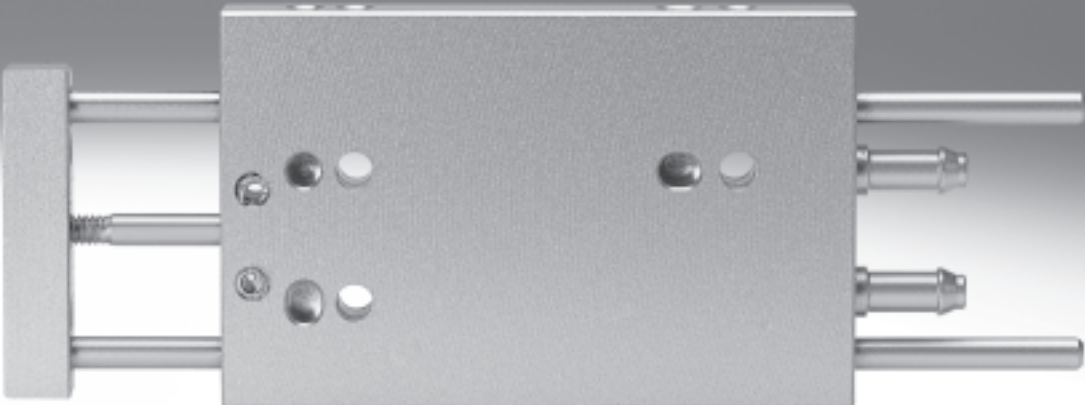

Mini guided cylinders DFC

Product range and peripherals overview

FESTO

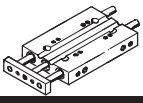
Function	Version	Type	Piston Ø [mm]	Stroke [mm]
Double-acting		DFC	4	5, 10, 15, 20
			6	5, 10, 15, 20, 25, 30
			10	5, 10, 15, 20, 25, 30

Piston Ø 4 mm

Piston Ø 6, 10 mm

Integrated push-in/threaded fitting

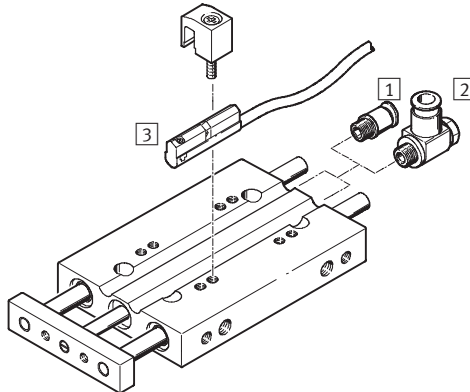
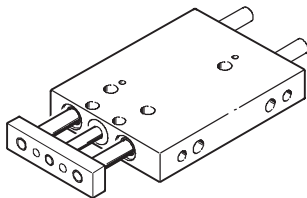

Accessories					
	Brief description	Piston Ø 4 mm	Piston Ø 6 mm	Piston Ø 10 mm	→ Page/Internet
1	Push-in/threaded fitting QSM	-	■	■	quick star
2	One-way flow control valve GRLZ	-	-	■	10
3	Proximity sensor SME/SMT-10	-	■	■	10

Mounting options

Horizontal mounting from above

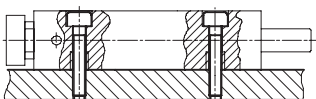

Horizontal mounting from below

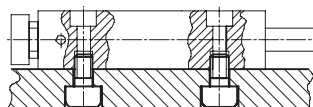

Side mounting from below

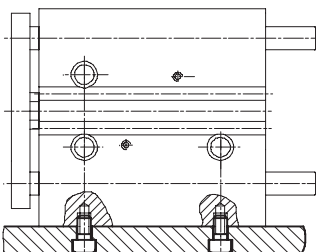

Yoke mounting

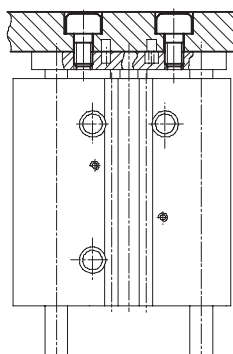

Mini guided cylinders DFC

Type code

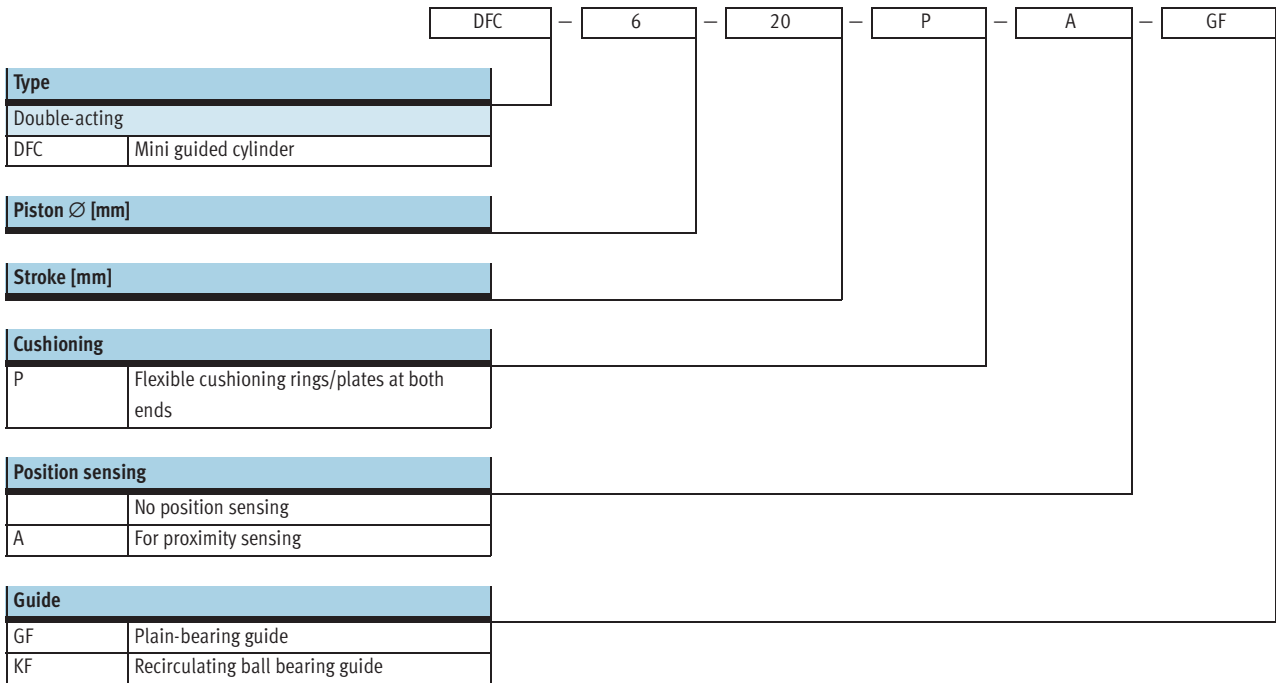

Mini guided cylinders DFC



Technical data

FESTO

Function

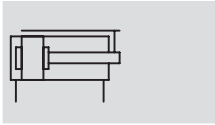
DFC-...
without end-position sensing



-  - Diameter
4, 6, 10 mm
-  - Stroke length
5 ... 30 mm
-  - www.festo.com

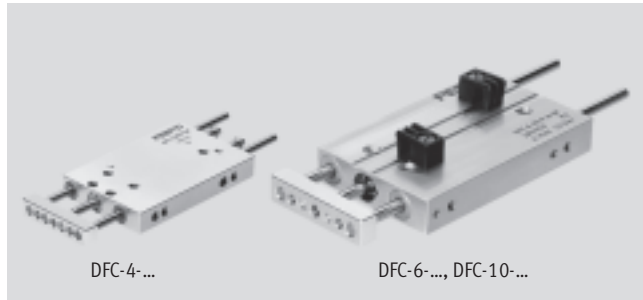

DFC-...-A-...

with end position sensing

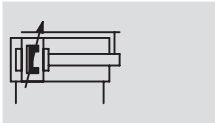

General technical data			
Piston \varnothing	4	6	10
Pneumatic connection	Barbed fitting PK-3 for 3 mm plastic tubing	M3	M5
Operating medium	Compressed air, filtered, lubricated or unlubricated		
Operating pressure [bar]	3.5 ... 7.0	1.5 ... 10.0	1.0 ... 10.0
Constructional design	Piston		
	Piston rod		
	Guide rods with yoke		
Cushioning	Flexible cushioning rings/plates at both ends		
Position sensing	-	For proximity sensing	
Type of mounting	Via through holes		
	Via female thread		
Mounting position	Any		
Protection against torsion/guide	Guide rod with yoke with plain-bearing guide		Guide rod with yoke with plain-bearing or ball bearing guide

Ambient conditions		
Variant	Plain-bearing guide GF	Recirculating ball bearing guide KF
Ambient temperature ¹⁾ [°C]	-5 ... +60	
Corrosion resistance class CRC ²⁾	2	-

1) Note operating range of proximity sensors.

2) Corrosion resistance class 2 according to Festo standard 940 070

Components requiring moderate corrosion resistance. Externally visible parts with primarily decorative surface requirements which are in direct contact with a surrounding industrial atmosphere or media such as cooling or lubricating agents.

Speeds [m/s] at maximum stroke length			
Piston \varnothing	4	6	10
Maximum speed	1.0	1.0	1.0
Minimum speed	0.1	0.1	0.1

Forces [N]			
Piston \varnothing	4	6	10
Theoretical force at 6 bar, advancing	7.5	17	47
Theoretical force at 6 bar, retracting	5.5	12.5	35

Mini guided cylinders DFC

Technical data

FESTO

Impact energy [J]			
Piston Ø	4	6	10
Max. impact energy at end positions	0.006	0.008	0.05

Permissible impact velocity:
$$v_{perm.} = \sqrt{\frac{2 \times E_{perm.}}{m_{dead} + m_{load}}}$$

Maximum permissible load:
$$m_{load} = \frac{2 \times E_{perm.}}{v^2} - m_{dead}$$

$v_{perm.}$ Permissible impact velocity
 $E_{perm.}$ Max. impact energy
 m_{dead} Moving load (drive)
 m_{load} Moving work load

 Note
 These specifications represent the maximum values which can be reached. Note the maximum permitted impact energy.

Maximum permissible load m as a function of the impact speed v

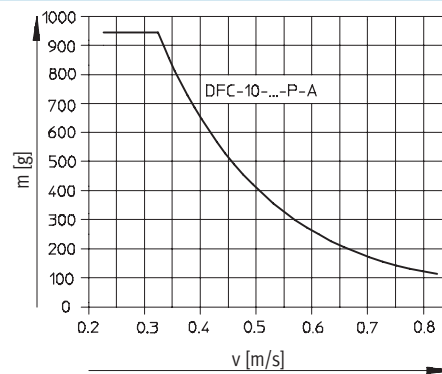
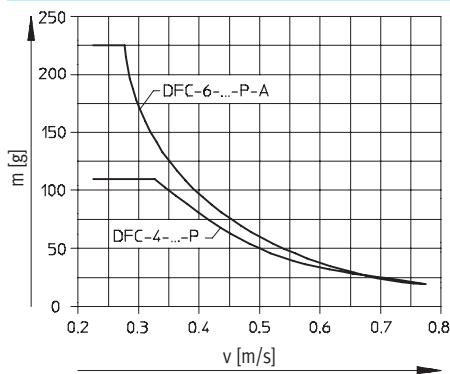

Weights [g]				
Piston Ø	4	6	10	
Product weight	at 5 mm stroke	10	28	91
	at 10 mm stroke	12	34	100
	at 15 mm stroke	15	39	108
	at 20 mm stroke	18	44	117
	at 25 mm stroke	–	49	125
	at 30 mm stroke	–	55	134
Moving load at 0 mm stroke	3.2	8.8	27.2	
Additional load per 10 mm stroke	1.3	2.8	7.2	

Materials

Sectional view

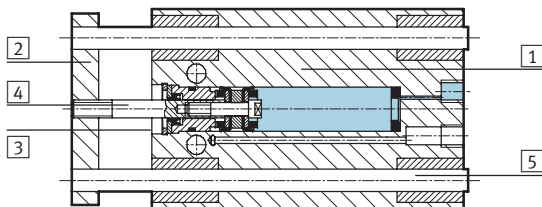

Mini guided cylinder		
1	Housing	Wrought aluminium alloy
2	Yoke plate	Wrought aluminium alloy
3	Cover	Wrought aluminium alloy
4	Piston rod	High-alloy stainless steel
5	Guide rods	High-alloy steel
–	Seals	Polyurethane, nitrile rubber

Mini guided cylinders DFC

Technical data

FESTO

Maximum effective load F [N]

Plain-bearing guide GF and recirculating ball bearing guide KF

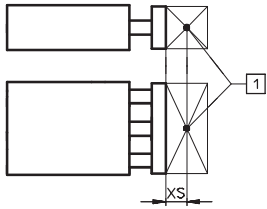

1 Centre of gravity of effective load

Piston Ø [mm]	XS [mm]	Stroke [mm]						
		5	10	15	20	25	30	
4	GF	5	1.7	1.7	1.7	1.7	–	–
	KF		–	–	–	–	–	–
6	GF	10	4.8	4.8	4.8	4.8	4.8	4.8
	KF		4.6	4.6	4.6	4.6	4.6	4.6
10	GF	15	12.2	12.2	12.2	12.2	12.2	12.2
	KF		9.8	9.8	9.8	9.8	9.8	9.8

Permissible torque load M [Nm]

Plain-bearing guide GF and recirculating ball bearing guide KF

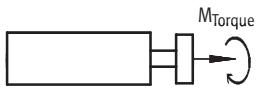

Piston Ø [mm]	Stroke [mm]	5	10	15	20	25	30
		4	GF	0.02	0.02	0.02	0.02
	KF	–	–	–	–	–	–
6	GF	0.1	0.1	0.1	0.1	0.1	0.1
	KF	0.1	0.1	0.1	0.1	0.1	0.1
10	GF	0.4	0.4	0.4	0.4	0.4	0.4
	KF	0.3	0.3	0.3	0.3	0.3	0.3

Torsional backlash p

Plain-bearing guide GF and recirculating ball bearing guide KF

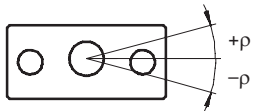

Piston Ø		4	6	10
In retracted state				
Torsional backlash [°]	GF	0.07	0.05	0.04
	KF	0.07	0.05	0.03
In advanced state with maximum stroke				
Torsional backlash [°]	GF	0.11	0.07	0.06
	KF	0.12	0.08	0.05

Mini guided cylinders DFC

Technical data

Deflection of piston rod

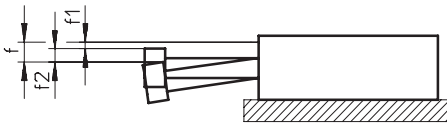

$$f = f_1 + f_2$$

f = Total deflection of piston rod

f₁ = Deflection due to bearing backlash = max. 0.02 mm

f₂ = Deflection due to lateral force

Deflection f₂ due to lateral force F as a function of the stroke

Piston Ø 4 mm

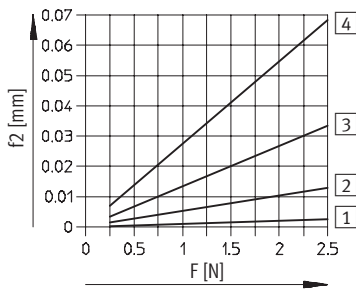

Piston Ø 6 mm

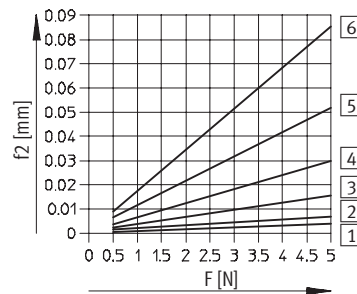

Piston Ø 10 mm

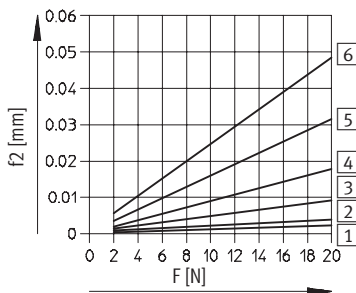

- 1 5 mm stroke
- 2 10 mm stroke
- 3 15 mm stroke
- 4 20 mm stroke
- 5 25 mm stroke
- 6 30 mm stroke

Mini guided cylinders DFC

Technical data



Dimensions

Download CAD data → www.festo.com

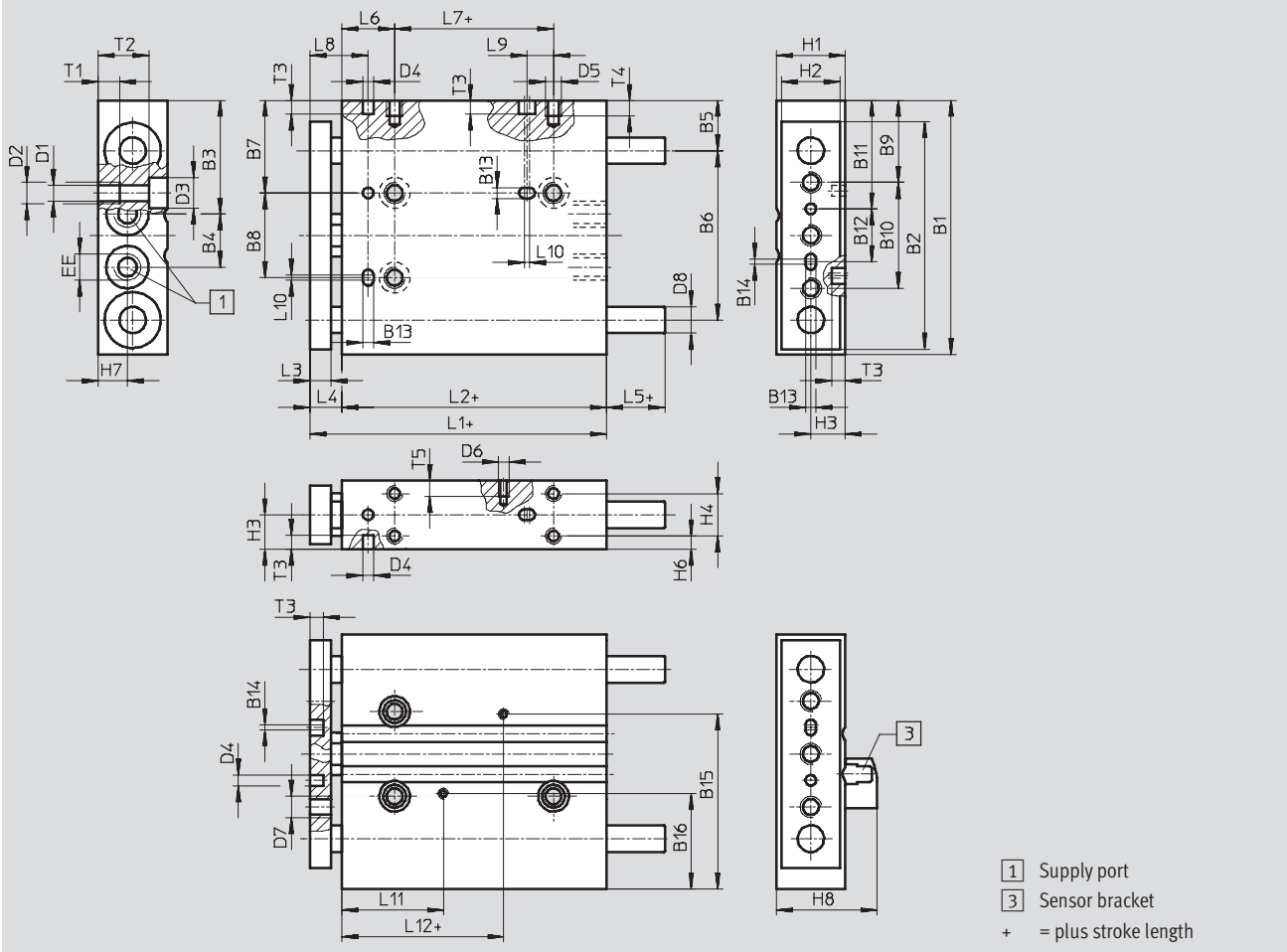

Piston Ø 4 mm

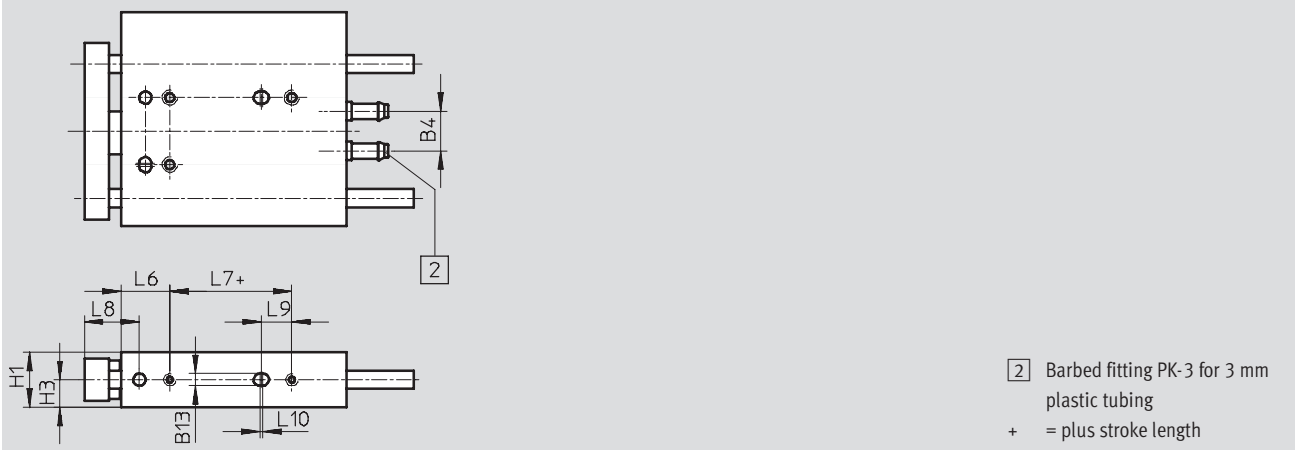

Mini guided cylinders DFC

Technical data

FESTO

∅ [mm]	B1	B2	B3	B4	B5	B6	B7	B8	B9	B10	B11	B12	B13 H8	B14	B15	B16	D1 ∅
4	24	20	9.8	7.4	6	15	9.5	8	8.5	10	11	5	2	-	-	-	2.1
6	35	29	17	6.5	8.5	22	14	11	12	15	15.75	8	2	1	26.2	12.8	2
10	48	43	21.5	10	9.5	32	17.5	16	15.5	20	20.5	10	2	1	33	18	3.2

∅ [mm]	D2	D3 ∅	D4 ∅ H8	D5	D6 ∅	D7	D8 ∅	EE	H1	H2	H3	H4	H6	H7	H8	L1	L2
4	-	-	2	M2	-	M2	2	-	5.5	4.5	2.75	-	2.75	2.75	-	24	18
6	M2.5	4	2	M2.5	M2	M2.5	3	M3	9	7	4.5	-	4.5	3.5	15	34	27
10	M4	5.8	2	M3	M2	M4	5	M5	13	11	6.5	8	2.5	5.5	19	48	40

∅ [mm]	L3	L4	L5	L6	L7	L8	L9	L10	L11	L12	T1	T2	T3	T4	T5
4	4	6	1	8	3	11	3.5	0.5	-	-	-	5.5	2	4	-
6	5	7	1	8	10	10	5	0.5	16	19.35	3	6.1	2.6	5	2.5
10	6	8	1	10	20	13	5	1	22.2	25.6	4	9.6	2.6	3	3

Ordering data					
Piston ∅ [mm]	Stroke [mm]	Plain-bearing guide GF		Recirculating ball bearing guide KF	
		Part No.	Type	Part No.	Type
4	5	189 479	DFC-4-5-P-GF	-	
	10	189 452	DFC-4-10-P-GF		
	15	189 453	DFC-4-15-P-GF		
	20	189 454	DFC-4-20-P-GF		
6	5	189 455	DFC-6-5-P-A-GF ¹⁾	189 461	DFC-6-5-P-A-KF ¹⁾
	10	189 456	DFC-6-10-P-A-GF ¹⁾	189 462	DFC-6-10-P-A-KF ¹⁾
	15	189 457	DFC-6-15-P-A-GF ¹⁾	189 463	DFC-6-15-P-A-KF ¹⁾
	20	189 458	DFC-6-20-P-A-GF ¹⁾	189 464	DFC-6-20-P-A-KF ¹⁾
	25	189 459	DFC-6-25-P-A-GF ¹⁾	189 465	DFC-6-25-P-A-KF ¹⁾
	30	189 460	DFC-6-30-P-A-GF ¹⁾	189 466	DFC-6-30-P-A-KF ¹⁾
10	5	189 467	DFC-10-5-P-A-GF ¹⁾	189 473	DFC-10-5-P-A-KF ¹⁾
	10	189 468	DFC-10-10-P-A-GF ¹⁾	189 474	DFC-10-10-P-A-KF ¹⁾
	15	189 469	DFC-10-15-P-A-GF ¹⁾	189 475	DFC-10-15-P-A-KF ¹⁾
	20	189 470	DFC-10-20-P-A-GF ¹⁾	189 476	DFC-10-20-P-A-KF ¹⁾
	25	189 471	DFC-10-25-P-A-GF ¹⁾	189 477	DFC-10-25-P-A-KF ¹⁾
	30	189 472	DFC-10-30-P-A-GF ¹⁾	189 478	DFC-10-30-P-A-KF ¹⁾

1) Mounting kits for proximity sensors included in scope of delivery.



Mini guided cylinders DFC

Accessories

FESTO

Ordering data – Proximity sensors for C-slot, magneto-resistive					Technical data → Internet: smt	
	Type of mounting	Switch output	Electrical connection, connection direction	Cable length [m]	Part No.	Type
N/O contact						
	Insertable in the slot lengthwise	PNP	Plug M8x1, 3-pin, in-line	0.3	173 220	SMT-10-PS-SL-LED-24
			Cable, 3-wire, in-line	2.5	173 218	SMT-10-PS-KL-LED-24

Ordering data – Proximity sensors for C-slot, magnetic reed					Technical data → Internet: sme	
	Type of mounting	Switch output	Electrical connection, connection direction	Cable length [m]	Part No.	Type
N/O contact						
	Insertable in the slot lengthwise	Contacting	Plug M8x1, 3-pin, in-line	0.3	173 212	SME-10-SL-LED-24
			Cable, 3-wire, in-line	2.5	173 210	SME-10-KL-LED-24

Ordering data – Connecting cables				Technical data → Internet: nebu		
	Electrical connection, left	Electrical connection, right	Cable length [m]	Part No.	Type	
	Straight socket, M8x1, 3-pin	Cable, open end, 3-wire	2.5	541 333	NEBU-M8G3-K-2.5-LE3	
			5	541 334	NEBU-M8G3-K-5-LE3	
	Angled socket, M8x1, 3-pin	Cable, open end, 3-wire	2.5	541 338	NEBU-M8W3-K-2.5-LE3	
			5	541 341	NEBU-M8W3-K-5-LE3	

Ordering data – One-way flow control valves				Technical data → Internet: grlz		
	Connection		Material	Part No.	Type	
	Thread	For tubing OD			Type	
	M5	3	Metal design	193 153	GRLZ-M5-QS-3-D	
		4		193 154	GRLZ-M5-QS-4-D	
		6		193 155	GRLZ-M5-QS-6-D	