

Modular electrical terminal CPX



Terminal CPX

Key features

FESTO

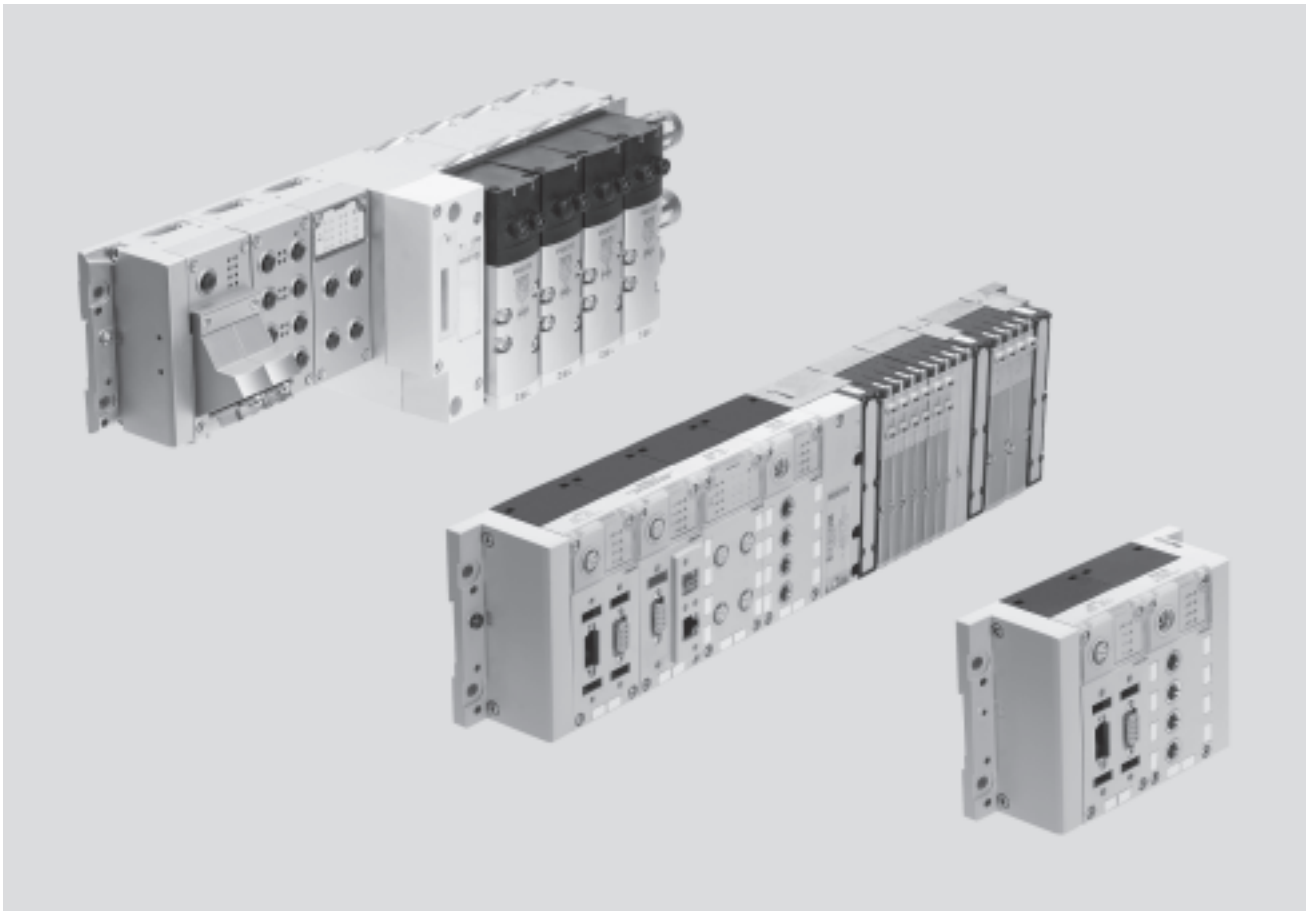

Key features

Installation concept

- Choice of multiple valve terminal types for different applications:
 - Type 03 MIDI/MAXI
 - Type 12 CPA
 - Type 32 MPA
 - Type 44/45 VTSA/VTSA-F
- Economical from the smallest configuration up to the maximum number of modules
- Up to 9 electrical input/output modules plus bus nodes and pneumatic interface/electronics modules for valves
- Extensive range of functions and connection options for the electrical modules
- Selectable connection technology for technically and economically optimised connections
- Can be used as a dedicated remote I/O module

Electrical

- High operating voltage tolerance ($\pm 25\%$)
- Choice of M18, 7/8" or AIDA push-pull connection for power supply
- Open to all common fieldbus protocols and Ethernet
- Optional function and technology modules for pre-processing
- IT services and TCP/IP such as remote maintenance, remote diagnostics, web server, SMS and e-mail alert
- Digital inputs and outputs, 4-fold/8-fold/16-fold, optionally available with individual channel diagnostics
- Analogue inputs and outputs, 2-fold/4-fold
- Temperature inputs
- IP65 and IP67 or IP20

Mounting

- Wall or H-rail mounting, also on mobile systems
- Conversions/extensions are possible at any time, individual linking with CPX metal design
- Modular system offering a range of configuration options
- Fully assembled and tested unit
- Lower costs for selection, ordering, assembly and commissioning thanks to the central CPX terminal
- Design of optimised control loop systems thanks to selectable pneumatic components
- Decentralised, subordinate installation system CPI improves cycle times by up to 30%
- Safe and convenient earthing thanks to earthing plate

Operation

- Fast troubleshooting thanks to an extensive selection of LEDs (some of which are multi-coloured) on the bus node and on all I/O modules
- Supports module and channel-oriented diagnostics
- On-the-spot diagnostics in plain text via handheld device
- Fieldbus/Ethernet remote diagnostics
- Innovative diagnostic support with integrated web server/web monitor or maintenance tool with USB adapter for PC
- Optimised commissioning thanks to parameterisable functions
- Reliability of service with connection blocks and modules that are quick to replace without changing the wiring

Terminal CPX

Key features

Pneumatic variants of the CPX terminal

The electrical CPX terminal is a modular peripheral system for valve terminals.

The system is specifically designed so that the valve terminal can be adapted to suit different applications.

The modular system design lets you

configure the correct number of valves, inputs and additional outputs to suit the application.

With valve terminal – decentralised

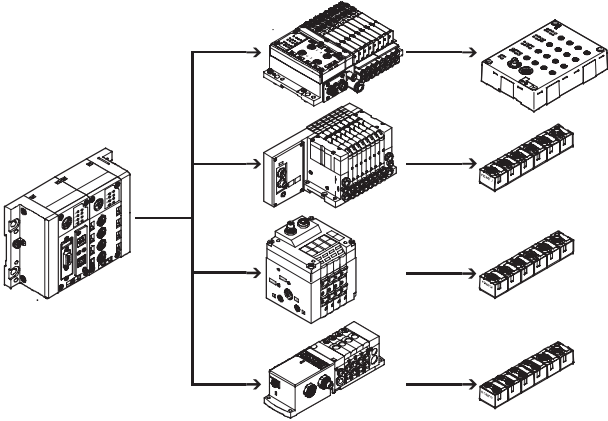

With valve terminal MPA – centralised

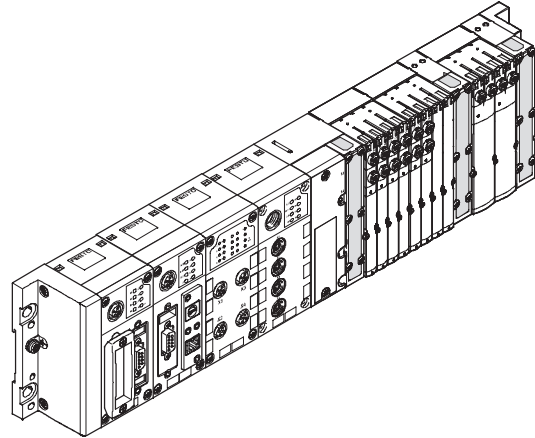

With valve terminal VTSA – centralised

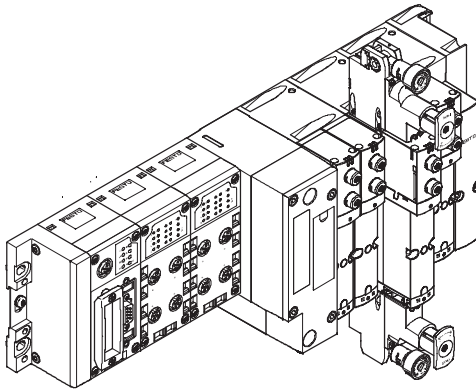

In metal version with valve terminal VTSA – centralised

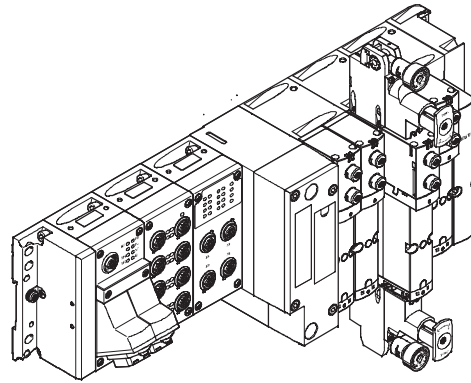

With valve terminal MIDI/MAXI – centralised

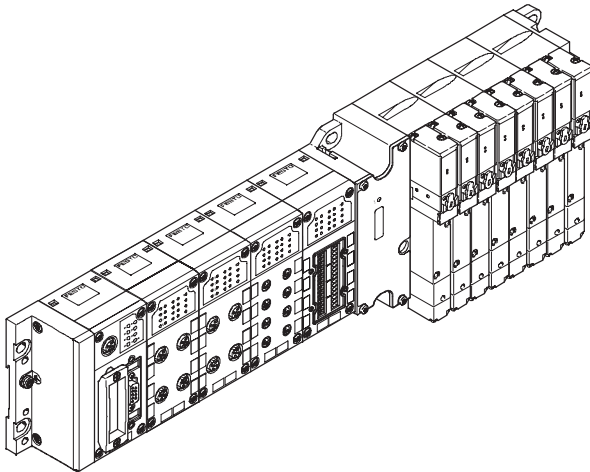

With valve terminal CPA – centralised

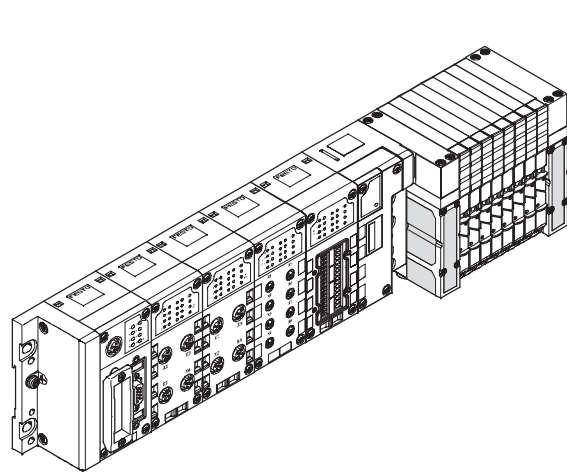

Terminal CPX

Key features

Variants of the CPX terminal controller (with fieldbus node, without pre-processing)

Fieldbus node

Different bus nodes are used for integration in the control systems of various manufacturers.

The CPX terminal can therefore be operated on over 90% of the most commonly used fieldbus systems:

- Profibus-DP
- Interbus
- DeviceNet

- CANopen
- CC-Link

Integration in universal networks based on Ethernet opens up new possibilities. Faster data transmission, real-time capability and above all additional IT services such

as file transfer, web servers, web monitor as integrated website inside the CPX terminal, SMS/e-mail alerts, etc. are opening up a wide range of synergies.

This incorporates standardised and universal communications technology across all areas, including operating

level, control level and field level with protection to IP 65/67.

The following protocols are supported:

- Ethernet/IP
- Modbus/TCP
- Profinet
- EtherCAT

Fieldbus node

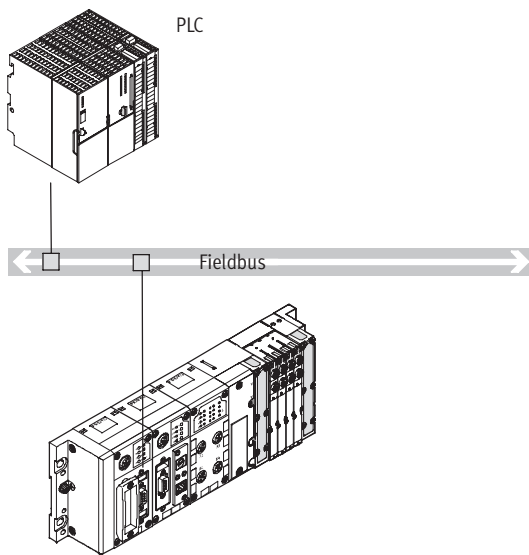

- Communication with higher-order controller via fieldbus
- No pre-processing
- Fieldbus protocol depending on CPX fieldbus node used
- Up to 512 I/Os, depending on the fieldbus node used

Fieldbus node Industrial Ethernet

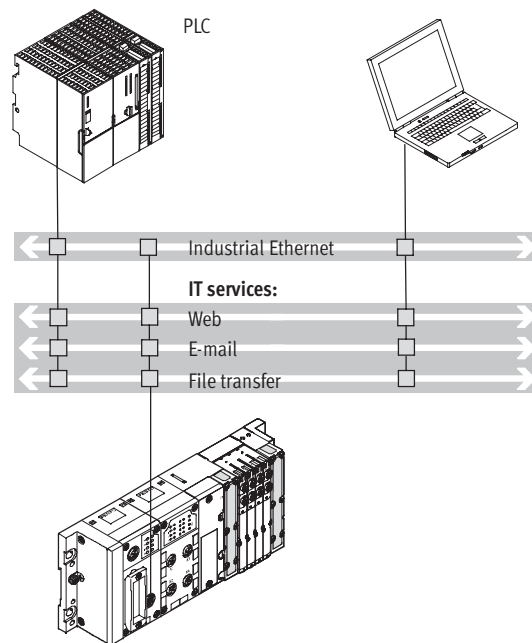

- Connection to a higher-order controller directly via Ethernet/IP, Modbus/TCP or Profinet
- No pre-processing
- Monitoring via Ethernet and web applications
- Up to 512 I/Os

Note

Every electrical connection can be combined with an appropriate number of I/O modules and/or pneumatic components, depending on its address capacity.

Likewise, every pneumatic variant of the CPX terminal can be operated with every electrical connection variant.

Terminal CPX

Key features

Variants of the CPX terminal controller (with pre-processing in the FEC)

Control block

The optional Front End Controller CPX-FEC, in parallel with a fieldbus node, permits simultaneous access via Ethernet and an integrated web

server, as well as autonomous pre-processing. Access via Modbus/TCP and EasyIP is also possible.

- Commissioning, programming and diagnostics using the Festo software tool FST 4.1 with hardware configurator.

With FEC in standalone mode

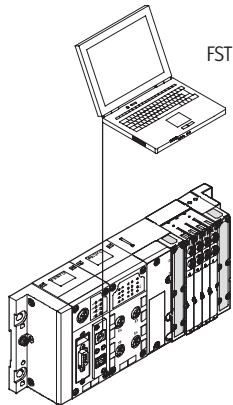

- Decentralised controller with direct machine mounting
- Interaction options via CPX-MMI or Front End Display (FED)
- Possibility of downloading programs via Ethernet (or via the programming interface)
- Supports full expansion of all CPX peripherals
- More than 300 I/Os

Beneficial application areas:

- Autonomous single workstations
- Interlinked, standalone subsystems
- Automation using IT technology

With FEC in Festo EasyIP mode

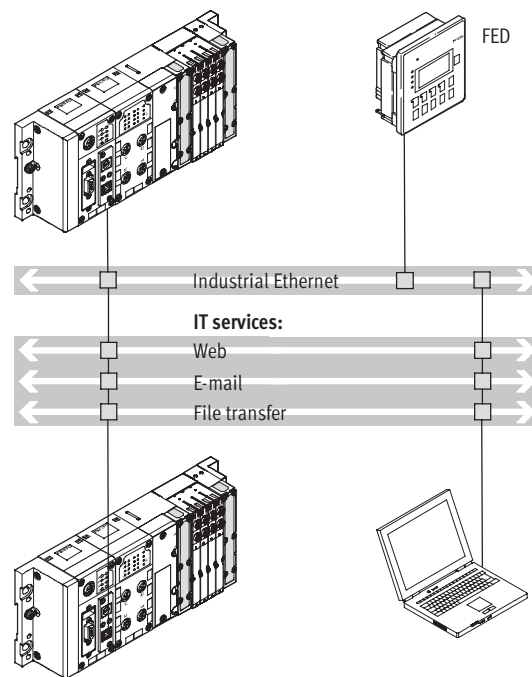

- Fast pre-processing of the CPX peripherals in the FEC
- Any data can be exchanged between the FEC via EasyIP
- Several FECs can be operated and monitored via one FED
- Remote diagnostics via an FED and CPX Web Monitor

- No higher-order controller is required
- More than 300 I/Os per CPX-FEC

Terminal CPX

Key features

Variants of the CPX terminal controller (with pre-processing in the FEC)

With FEC as remote controller on Ethernet

Remote controller on Ethernet as the pre-processing unit for decentralised, standalone subsystems using IT technology.

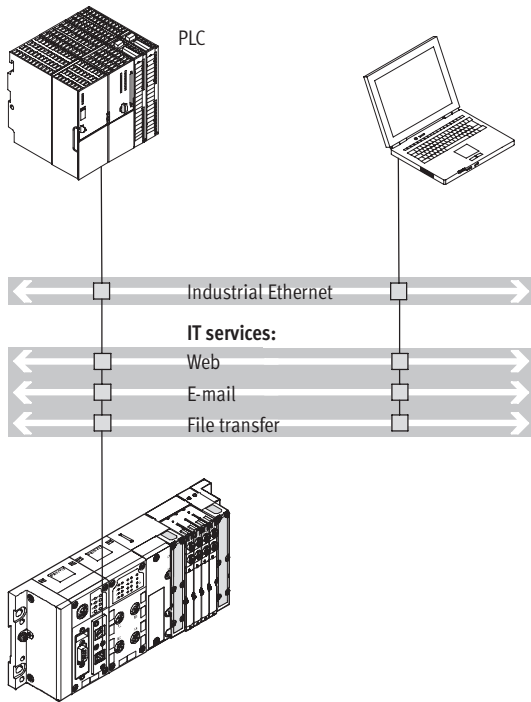

- Connection to a higher-order controller directly via Ethernet, no further fieldbus nodes are required
- Monitoring via Ethernet and web applications

- Pre-processing of the CPX peripherals through CPX-FEC
- More than 300 I/Os

With FEC as remote controller on fieldbus

Fieldbus remote controller (combination with fieldbus nodes for Interbus, Profibus-DP, Profinet, CANopen,

DeviceNet, CC-Link or EtherCAT) as the pre-processing unit for distributed, standalone subsystems.

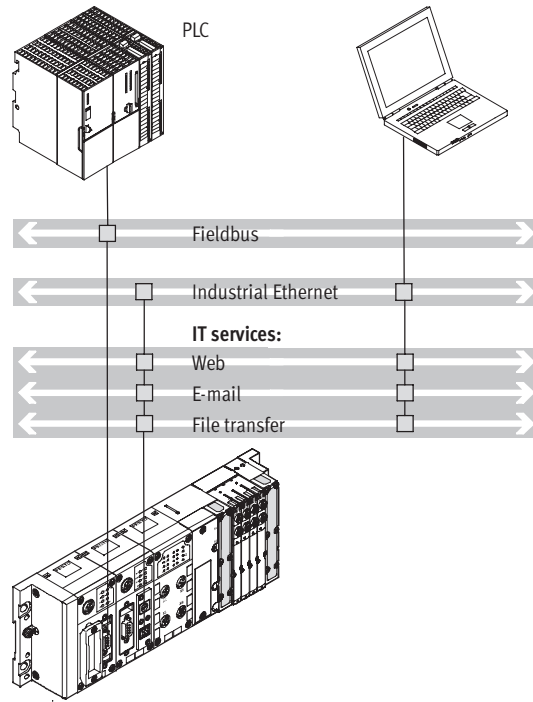

- Fast pre-processing of the CPX peripherals in the FEC
- Communication with higher-order controller via fieldbus
- Optional additional monitoring via Ethernet and web applications

- Downloading of programs via programming interface
- More than 300 I/Os, fieldbus nodes are only used for communication with the higher-order PLC
- Two fieldbus nodes for redundant communication configuration

Terminal CPX

Key features

CPX Web Monitor – Online diagnostics for the CPX terminal → 58

What is a CPX Web Monitor?

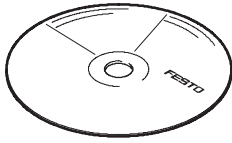

The CPX Web Monitor is a software tool from Festo for all CPX modules with integrated web server and Ethernet connection:

- Supplied on CD-ROM
- Installation on PC
- Adaptable to application
- Loading via Ethernet to the web server of the CPX module

What can a CPX Web Monitor do?

The Web Monitor dynamically visualises information about the CPX system and its modules via Ethernet in the browser of a PC:

- Status and diagnostics of the CPX system via modules and channels
- Status of the channels/valves

- SMS or e-mail alerts can be set
 - Reading of CPX error memory (fault trace)
 - Setting of outputs (force mode)
- Three password-protected access levels protect access to the CPX terminal.

How does the CPX Web Monitor communicate?

An IP address is assigned to the integrated web server. Depending on the performance of the connected Ethernet network, the CPX web server can be accessed from any PC.

Controllers or intelligent display and operating units can communicate with the CPX terminal.

What advantages does a CPX Web Monitor have?

- Expensive servicing is avoided
- Remote maintenance and monitoring of important device functions (counters) for the prevention of unjustified rights of recourse

- Preventive maintenance for reduced downtimes
- No engineering/no development of web applications

CPX Web Monitor – Application examples

Channel-oriented diagnostics

- Channel-specific status and error message of an I/O module
- Error message in "plain text" describing the type of error
- Exact error identified and appropriate service tasks available

Possible error messages:

- Short circuit
- Overload
- Open load
- Supply voltage below the tolerance limit

Monitoring of analogue values

- Channel-specific status and error message of an analogue I/O module
- Display in plain text
- Dynamic display of the current values at the inputs/outputs

Possible error messages:

- Open load
- Upper or lower limit value exceeded

Error memory (fault trace)

Quick access to the last 40 diagnostic results with timestamp.

Assistance in finding sporadic errors and statistical accumulations.

Plug and work with FEDs

The CPX Web Monitor can be implemented directly on all Festo touchpanels with the Windows CE operating system

- FED 710 with 7.5" TFT display
- FED 1010 with 10.4" TFT display
- FED 2010 with 12.1" TFT display
- FED 5010 with 15" TFT display

Convenient remote maintenance via Ethernet (TCP or Easy IP) is thus possible.

Terminal CPX

Key features

Connection of inputs and outputs to the CPX terminal

Digital and analogue CPX I/O modules

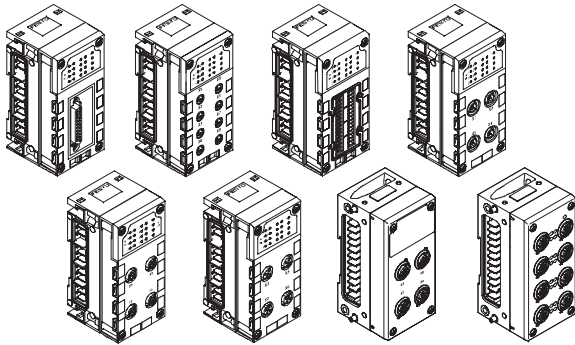

Electrical connection

The connection technology for the sensors and additional actuators offers a wide range of digital and analogue input and output modules and is freely selectable – depending on your standards or application. Connection blocks in plastic or metal can be freely combined:

- Metal version
 - M12-5-PIN
- Plastic version
 - M12-5-PIN
 - M12-5-PIN with quick lock and metal thread
 - M12-8-PIN
 - M8-3-PIN
 - M8-4-PIN
 - Sub-D
 - Harax®
 - CageClamp® (with cover also for IP65/67)

With CPX-CP interface

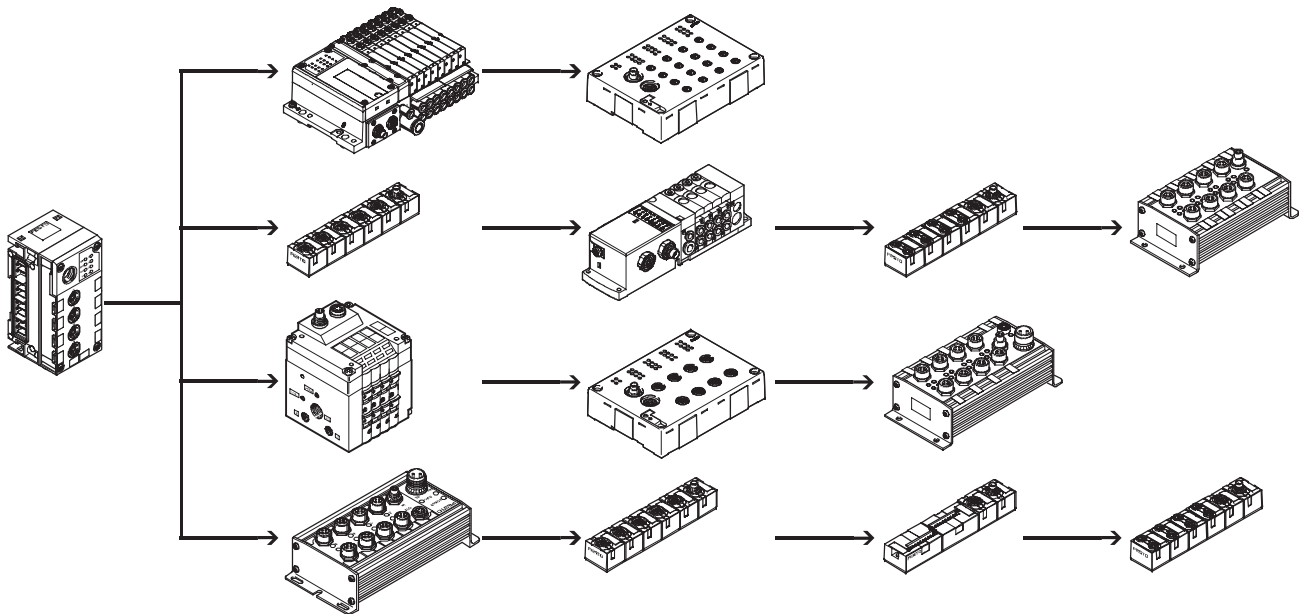

- Up to 4 strings per CP interface possible
- Up to 4 subordinate CP modules can be combined in a string
- Up to 32 I/Os can be connected per string
- Modules with M8, M12 and terminal connection
- Several CP interface modules can be combined in one CPX terminal (depending on the controller used).
- Combination of central CPX I/O modules and decentrally mounted I/O modules of the CPI installation system.

Combined centralised and decentralised connection (valve terminal with CP interface/output module)

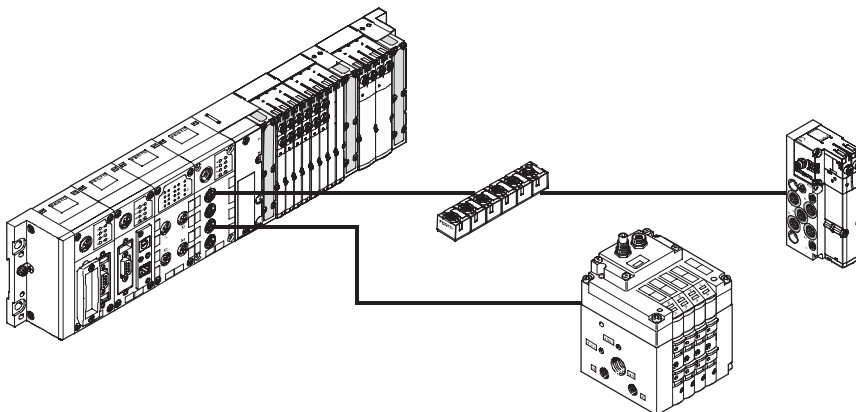

- Can be scaled to different requirements within a system
- One control interface in the system, reduces installation complexity with concentrated and widely dispersed actuators
- Enables the implementation of an optimum electrical and pneumatic control loop system

Terminal CPX

Key features

Connection of inputs and outputs to the CPX terminal With CPX-CMXX multi-axis interface

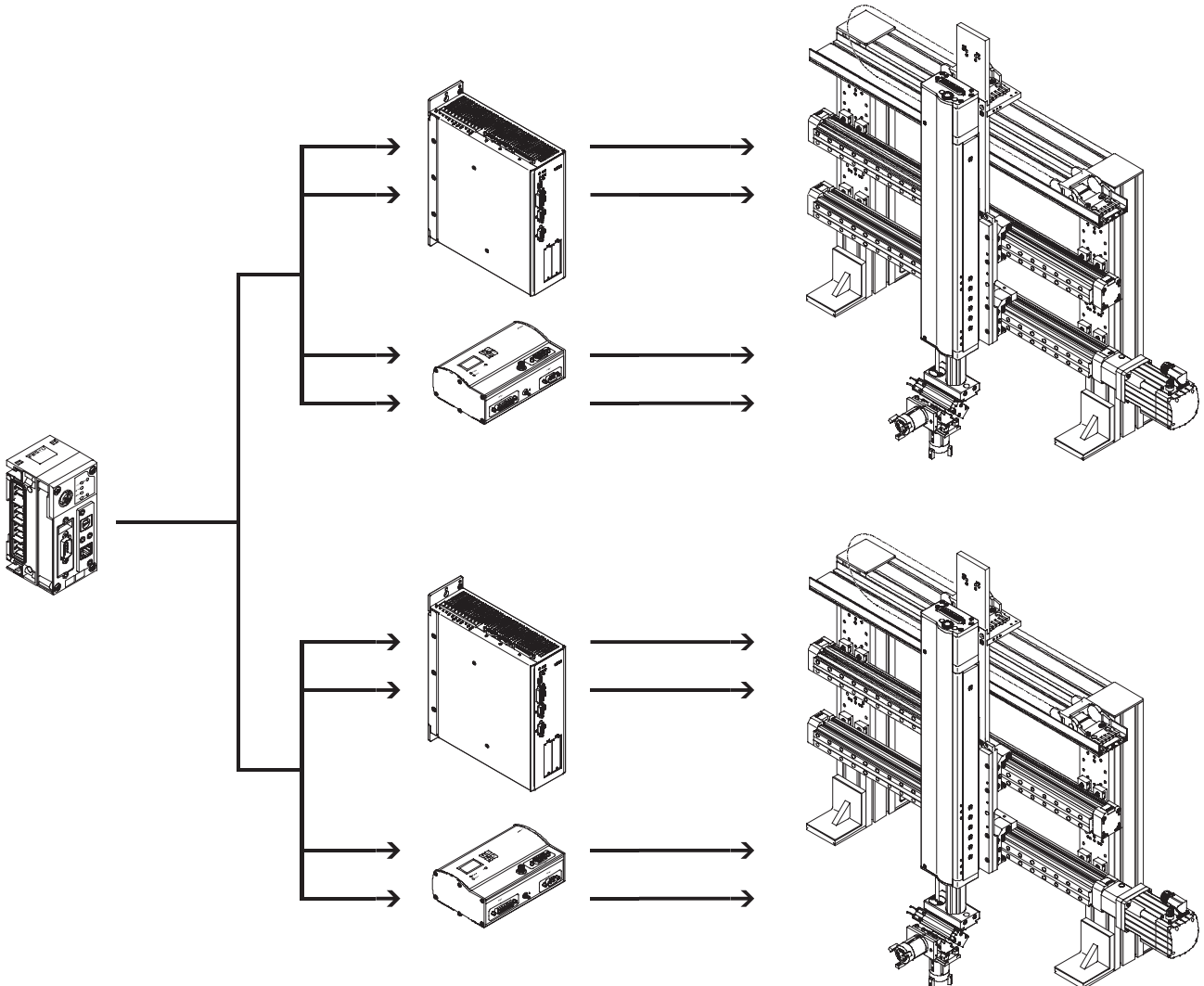

- Per CPX-CMXX 2 axis groups each with up to 4 axes
- Up to 1024 positioning records per axis group

- 2-axis gantries
- 3-axis gantries

Several CP interface modules can be combined in one CPX terminal (depending on the controller used).

Combination of central CPX I/O modules and decentrally mounted I/O modules of the CPI installation system.

Ordering

The CPX terminal with valve terminal is fully assembled according to order specifications and individually tested. The finished valve terminal consists of the electrical peripherals including the desired actuation and the selected components of the VTSA (ISO), VTSA-F, CPA, MPA or MIDI/MAXI modules. The CPX terminal with valve terminal is ordered using two separate order

codes. One order code defines the electrical peripherals type CPX, while the other specifies the pneumatic components of the valve terminal. The electrical peripherals type CPX can also be configured without a valve terminal and can be used on a fieldbus. For this order, only the order code for the electrical peripherals is required.

The order lists for the pneumatic components can be found in

- ➔ Internet: type 44 (Valve terminal type 44 VTSA)
- ➔ Internet: type 45 (Valve terminal type 45 VTSA-F)
- ➔ Internet: type 12 (Valve terminal type 12 CPA)
- ➔ Internet: type 32 (Valve terminal type 32 MPA)

➔ Internet: type 03 (Valve terminal type 03 VIMP-/VIFB-03)

The order lists for the CP/CPI components can be found in

- ➔ Internet: ctec (Installation system CPI)

Complete overview of modules

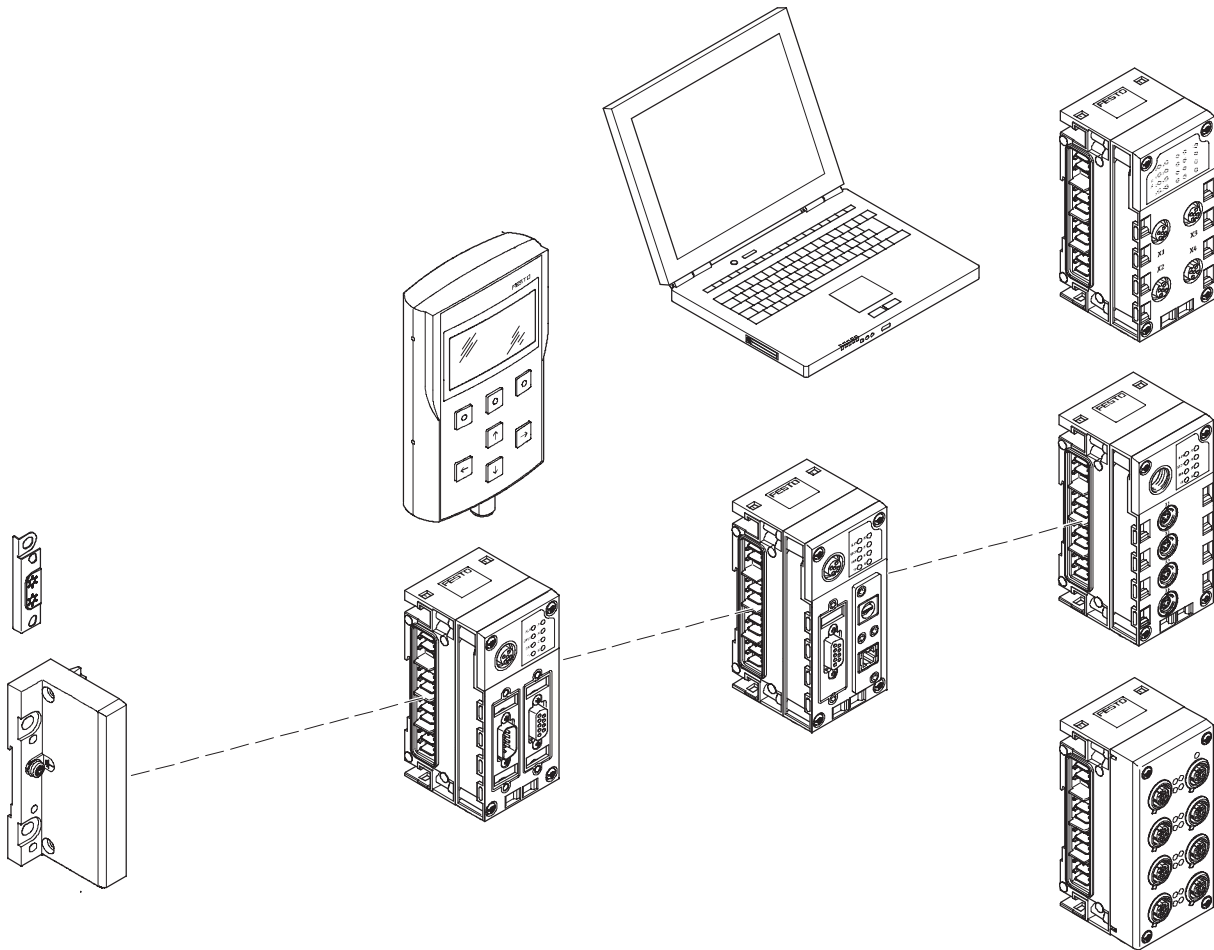

End plate

- Mounting holes for wall mounting
- Functional earthing connection
- Special earthing plate for safe and easy connection to the machine bed or H-rail

Bus node

- Fieldbus/Industrial Ethernet connection using various types of connection technology
- Setting of fieldbus parameters via DIL switch
- Display of fieldbus and peripherals status via LED
- Profinet to AIDA standard in metal housing

Handheld control unit

- Connection to bus nodes or control block
- Display and modification of parameter settings
- Plain text display for texts, messages (e.g. individual channel diagnostics, condition monitoring), menus, etc.

Control block

- Pre-processing, autonomous controller or remote unit CPX-FEC
- Connection via Ethernet TCP/IP or Sub-D programming interface
- Setting of operating modes via DIL switch and program selection via rotary switch

Web Monitor

- Integrated website inside the CPX terminal
- Dynamic status display
- Online diagnostics
- SMS/e-mail alert

Input/output modules

- Combination of
- Interlinking block
 - Electronics module
 - Connection block

CP interface

- CP interface for decentralised installation systems, thus optimising the pneumatic control loop system (short tubing lengths/short cycle times)
- Up to 4 strings with up to 4 modules each and up to 32 I/Os in total per string
- Power supply and bus interface via the same cable

Terminal CPX

Peripherals overview

Complete overview of modules

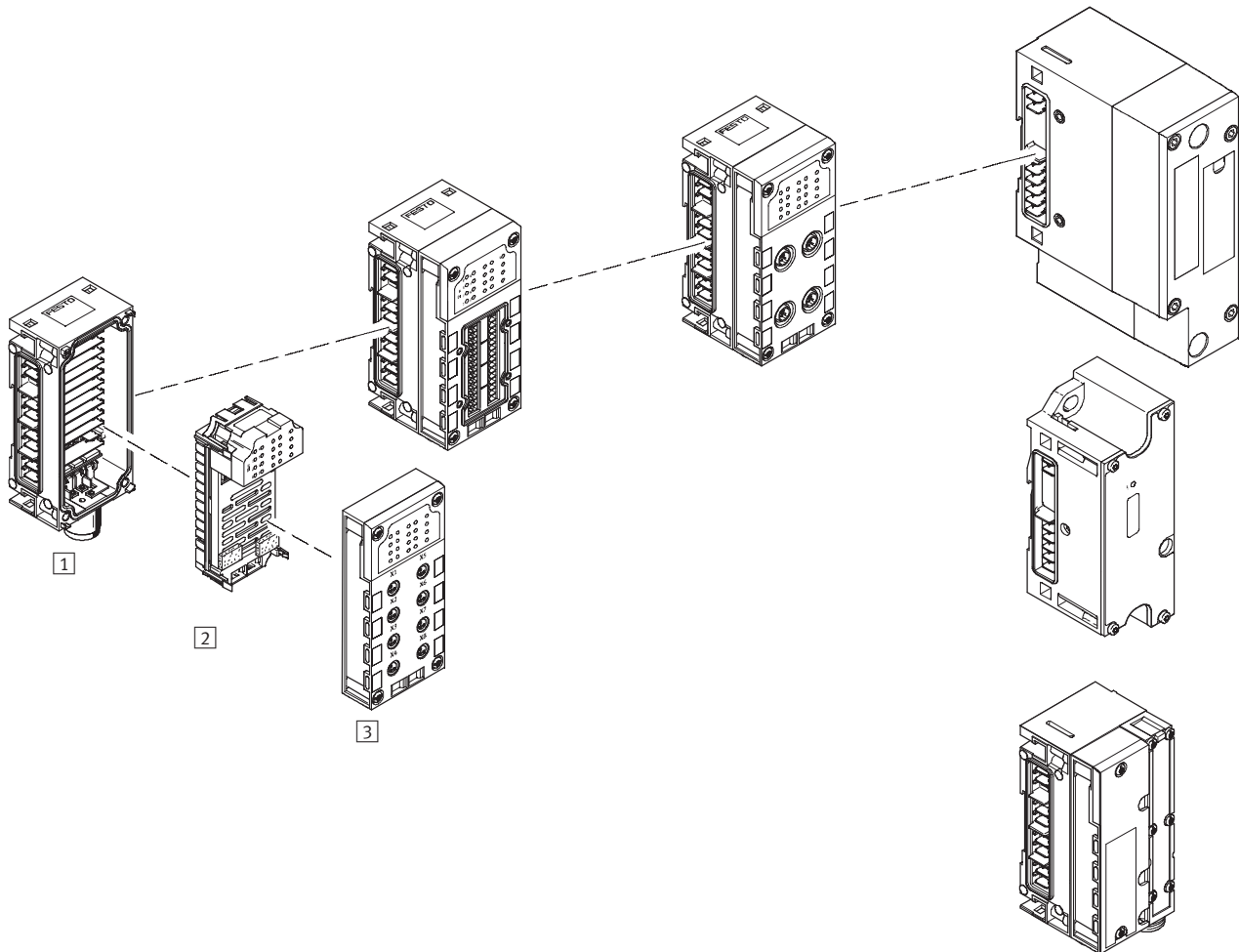

Input/output modules

1 Interlinking block

- Internal linking of the power supply and serial communication
- External power supply for the entire system
- Additional power supply for outputs or valves
- M18, 7/8" or AIDA push-pull connection accessories
- Plastic version: Linking with tie rods
- Metal version: Individual linking with M6 screws, individually expandable

2 Electronics module

- Digital inputs for connecting the sensors
- Digital outputs for activation of additional actuators
- Analogue inputs
- Temperature inputs (analogue)
- Analogue outputs

3 Connection block

- Selectable connection technology with 8 variants
- Protection class IP65/IP67 or IP20
- Freely combinable with the electronics modules
- M8/M12/Sub-D/quick connector
- M8/M12/Sub-D, etc. connecting cables
- Modular system for M8/M12 connecting cables
- M12 connection technology for the metal version

Pneumatic interface

- MPA1/2
- VTSA/VTSA-F
- MIDI/MAXI
- CPA10/14

Individual overview of modules

Bus node

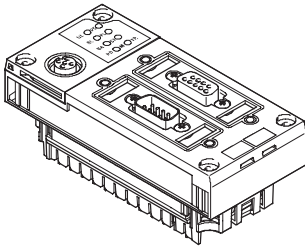

Bus node for

- Profibus-DP
- Interbus
- DeviceNet
- CANopen
- CC-Link
- Ethernet/IP
(integrated web server)
- Profinet
(integrated web server)

Control block for controlling valves

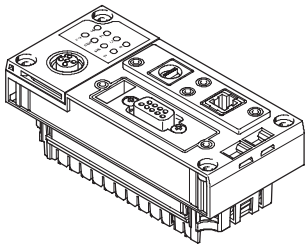

Control block

- Ethernet interface
- Modbus/TCP
- EasyIP
- Integrated web server
- Sub-D programming interface

CP interface

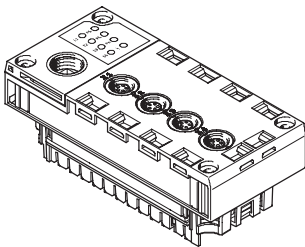

CP interface

- 4 CP strings
- Max. 4 modules per string
- 32 I/O per string
- CPI functionality

Control block for controlling electric drive units

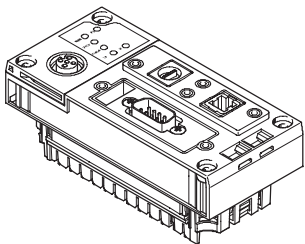

Multi-axis interface

- Ethernet interface
- 2 axis groups with max. 4 axes per group
- Per axis group max. 1024 positioning records

Terminal CPX

Peripherals overview

Individual overview of modules

Plastic connection block

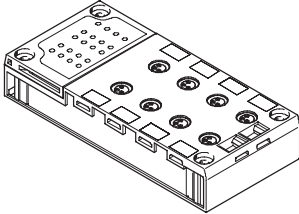

Direct machine mounting
(protection class IP65/IP67)

- M8-3-PIN
- M8-4-PIN
- M12-5-PIN
- M12-5-PIN Quick lock, metal thread screened
- M12-8-PIN
- Sub-D
- Quick connector
- Spring loaded terminal with cover

Protected fitting space
(protection class IP20)

- Spring loaded terminal

Screening concept

- Optional screening plate for connection blocks with M12 connection technology

Metal connection block

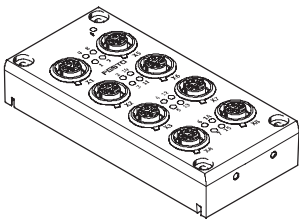

Direct machine mounting
(protection class IP65/IP67)

- M12-5-PIN

Individual overview of modules

Digital electronics module for inputs/outputs

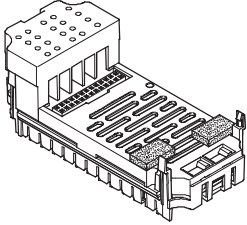

Digital inputs and outputs

- 4 digital inputs
- 8 digital inputs NPN
- 8 digital inputs PNP
- 8 digital inputs PNP with individual channel diagnostics
- 16 digital inputs
- 16 digital inputs with individual channel diagnostics
- 4 digital outputs (1 A per channel, individual channel diagnostics)
- 8 digital outputs (0.5 A per channel, individual channel diagnostics)
- 8 digital outputs (2.1 A/50 W lamp load per channel pair, individual channel diagnostics)

Multi I/O modules

- 8 digital inputs and 8 digital outputs

Analogue electronics module for inputs/outputs

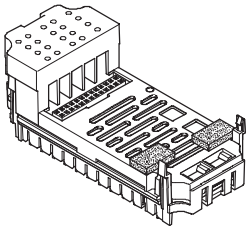

Analogue inputs

- 2 analogue inputs (0 ... 10 V DC, 0 ... 20 mA, 4 ... 20 mA)
- 4 analogue inputs (0 ... 20 mA, 4 ... 20 mA)

Analogue temperature inputs

- 4 analogue inputs for measuring temperature (Pt100, Pt200, Pt500, Pt1000, Ni100, Ni120, Ni500, Ni1000)
- 4 analogue inputs for temperature sensing (thermocoupler and Pt1000 sensor for cold-position compensation)

Analogue outputs

- 2 analogue outputs (0 ... 10 V DC, 0 ... 20 mA, 4 ... 20 mA)

Terminal CPX

Peripherals overview

Individual overview of modules

Plastic interlinking block – Linking using tie rods

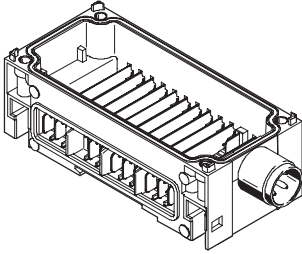

System linking

- Different voltage values for supplying the modules
- Serial communication between the modules

System supply

- M18, 4-pin
- 7/8" 4- or 5-pin

In addition to system linking, power supply for the

- electronics plus sensors (16 A)
- valves plus actuators (16 A)

Additional power supply

In addition to system linking, power supply for the

- actuators (16 A per supply)

Power supply for the

- valves (16 A per supply)

Expandability

- Can be expanded to include an interlinking block with tie rod expansion CPX-ZA-1-E

 Note

The max. current is limited to 12 A with the 7/8" system supply. When using a conventional pre-assembled cable, the max. current is limited to 8 A.

Metal interlinking block – Individual linking

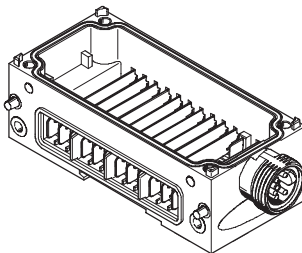

System linking

- Different voltage values for supplying the modules
- Serial communication between the modules

System supply

- 7/8" 5-pin
- AIDA push-pull

In addition to system linking, power supply for the

- electronics plus sensors (16 A)
- valves plus actuators (16 A)

Additional power supply

In addition to system linking, power supply for the

- actuators (16 A per supply)

Power supply for the

- valves (16 A per supply)

Expandability

- Can be expanded up to 10 interlinking blocks

 Note

The max. current is limited to 12 A with the 7/8" system supply. When using a conventional pre-assembled cable, the max. current is limited to 8 A.

 Note

Interlinking blocks made from plastic (tie rods) and from metal (individual linking) cannot be combined due to the fact that they have different types of linking.

Terminal CPX

Peripherals overview

FESTO

Individual overview of modules

Pneumatic interface MPA

→ 158

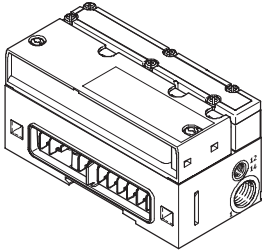

- Valve terminal
- MPA1 (360 l/min)
 - MPA2 (700 l/min)
 - Up to 128 solenoid coils
 - Up to 16 modules can be configured
 - For CPX plastic version
 - For CPX metal version

Pneumatic interface VTSA/VTSA-F

→ 159

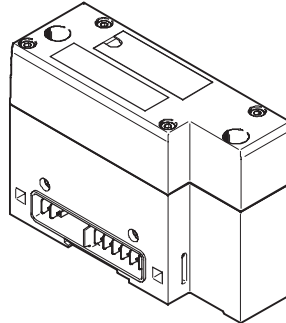

- Valve terminal
- 18 mm: Valve flow rate up to 700 l/min
 - 26 mm: Valve flow rate up to 1,400 l/min
 - 42 mm: Valve flow rate up to 1,500 l/min
 - Max. 32 valve positions/ max. 32 solenoid coils
 - For CPX plastic version
 - For CPX metal version

Pneumatic interface MIDI/MAXI

→ 160

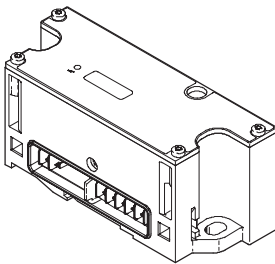

- Valve terminal
- MIDI valves (500 l/min) and/or MAXI valves (1,250 l/min)
 - Up to 26 solenoid coils
 - Setting of the number of valves via DIL switch
 - For CPX plastic version
 - For CPX metal version

Pneumatic interface CPA

→ 162

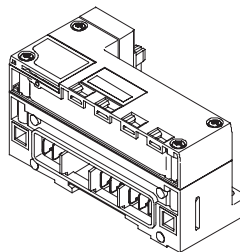

- Valve terminal
- CPA10 (300 l/min)
 - CPA14 (600 l/min)
 - Up to 22 solenoid coils
 - Setting of the number of valves via DIL switch
 - For CPX plastic version

Plastic end plate

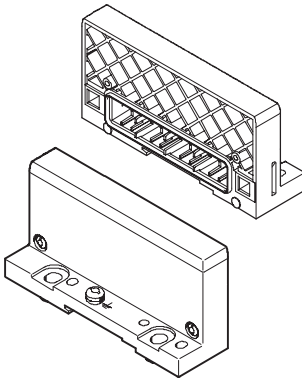

- End plate
- Left-hand
 - Right-hand (for use without valves)

Metal end plate

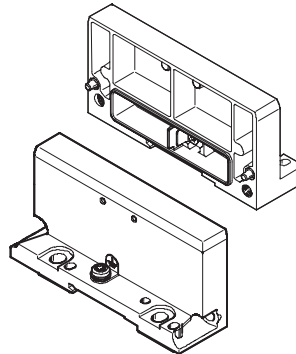

- End plate
- Left-hand
 - Right-hand (for use without valves)

Earthing plate (for plastic end plate)

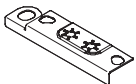

- Earthing plate
- For safe and easy connection to the machine bed or H-rail, suitable for right-hand and left-hand end plate
 - Assembly and earthing in a single processing step, which means:
 - 50% time saving
 - No additional material required

Terminal CPX

Peripherals overview

FESTO

General basic data and guidelines

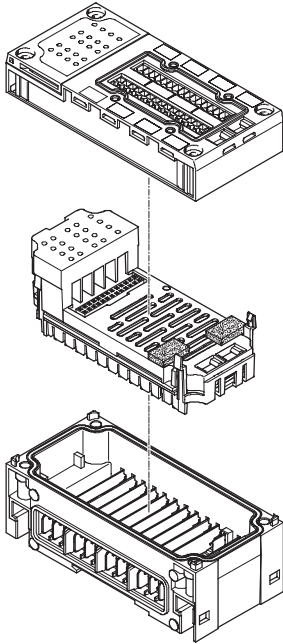

Max. 11 modules in total:

- One bus node and/or one control block, freely positionable
- Up to 9 further input/output modules, freely positionable
- An additional pneumatic interface, always positioned as the last module on the right-hand side
 - For VTSA, VTSA-F, CPA and MIDI/MAXI: fixed operating range, set using DIL switch
 - For MPA: 16 MPA modules can be configured
- Address capacity max. 512 inputs and 512 outputs, depending on bus node or control block
- One interlinking block with system supply, freely positionable
- Multiple interlinking blocks with additional power supply, always positioned to the right of the interlinking block with system supply
- The connection blocks can, with just a small number of exceptions, be freely combined with the electronics modules for inputs/outputs, also metal with plastic version (→ table below)
- All electronics modules for inputs/outputs can be combined with any interlinking block
- Interlinking blocks made from plastic (tie rods) and from metal (individual linking) cannot be combined due to the fact that they have different types of linking

Combinations of connection blocks with digital input modules						
Connection blocks	Digital electronics modules					
	CPX-4DE	CPX-8DE	CPX-16DE	CPX-M-16DE-D	CPX-8DE-D	CPX-8NDE
Plastic version with mounting screws for mounting on plastic interlinking blocks						
CPX-AB-8-M8-3POL	■	■	-	-	■	■
CPX-AB-8-M8X2-4POL	-	-	■	-	-	-
CPX-AB-4-M12x2-5POL	■	■	-	-	■	■
CPX-AB-4-M12x2-5POL-R	■	■	-	-	■	■
CPX-AB-4-M12-8POL	-	-	-	-	-	-
CPX-AB-8-KL-4POL	■	■	■	-	■	■
CPX-AB-1-SUB-BU-25POL	■	■	■	-	■	■
CPX-AB-4-HAR-4POL	■	■	-	-	■	■
Plastic version with mounting screws for mounting on metal interlinking blocks						
CPX-AB-8-M8x2-4P-M3	-	-	■	-	-	-
CPX-AB-4-M12-8P-M3	-	-	-	-	-	-
CPX-AB-4-M12x2-5P-R-M3	■	■	-	-	■	■
Metal version with mounting screws for mounting on metal and plastic interlinking blocks						
CPX-M-4-M12x2-5POL	■	■	-	-	■	■
CPX-M-8-M12x2-5POL	-	-	-	■	-	-

Combinations of connection blocks with digital output modules and multi I/O modules				
Connection blocks	Digital electronics modules			
	CPX-4DA	CPX-8DA	CPX-8DA-H	CPX-8DE-8DA
Plastic version with mounting screws for mounting on plastic interlinking blocks				
CPX-AB-8-M8-3POL	■	■	-	-
CPX-AB-8-M8X2-4POL	■	■	■	-
CPX-AB-4-M12x2-5POL	■	■	-	-
CPX-AB-4-M12x2-5POL-R	■	■	■	-
CPX-AB-4-M12-8POL	-	-	-	■
CPX-AB-8-KL-4POL	■	■	■	■
CPX-AB-1-SUB-BU-25POL	■	■	■	■
CPX-AB-4-HAR-4POL	■	■	-	-
Plastic version with mounting screws for mounting on metal interlinking blocks				
CPX-AB-8-M8x2-4P-M3	■	■	■	-
CPX-AB-4-M12-8P-M3	-	-	-	■
CPX-AB-4-M12x2-5P-R-M3	■	■	■	-
Metal version with mounting screws for mounting on metal and plastic interlinking blocks				
CPX-M-4-M12x2-5POL	■	■	■	-
CPX-M-8-M12x2-5POL	-	-	-	-

Terminal CPX

Peripherals overview

Combinations of connection blocks with analogue electronics modules for inputs and outputs					
Connection blocks	Analogue electronics modules				
	CPX-2AE-U-I	CPX-4AE-I	CPX-4AE-T	CPX-4AE-TC	CPX-2AA-U-I
Plastic version with mounting screws for mounting on plastic interlinking blocks					
CPX-AB-4-M1 2x2-5POL	■	■	■	■	■
CPX-AB-4-M1 2x2-5POL-R	■	■	■	■	■
CPX-AB-8-KL-4POL	■	■	■	■	■
CPX-AB-1-SUB-BU-25POL	■	■	-	-	■
CPX-AB-4-HAR-4POL	-	-	■	-	-
Plastic version with mounting screws for mounting on metal interlinking blocks					
CPX-AB-4-M1 2x2-5P-R-M3	■	■	■	■	■
Metal version with mounting screws for mounting on metal and plastic interlinking blocks					
CPX-M-4-M1 2x2-5POL	■	■	■	■	■

Terminal CPX

Key features – Electrical components

Electrical connection – Connection block

CPX-AB-8-M8-3POL with M8-3POL connection

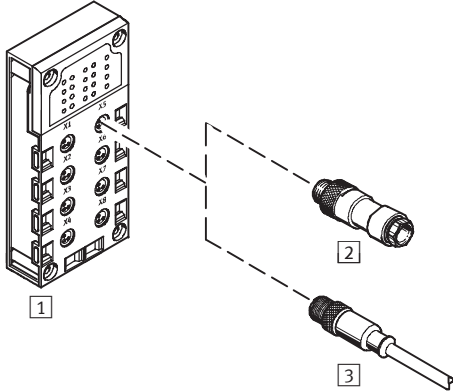

- Compact for pre-assembled individual connection
- 8 sockets
- 3-pin design for connection of 1 channel per socket



Note

Festo delivers pre-assembled M8/M12 connecting cables (NEBU modular system) on customer request:

- Individual
- Fits perfectly
- Installation-saving

Combination of connection block with electrical connection technology

Connection block	Connection technology	Plug connector/connecting cable	Selectable connection technology
1 CPX-AB-8-M8-3POL	Socket, M8, 3-pin	2 SEA-GS-M8	Solderable lugs
		2 SEA-3GS-M8-S	Screw terminals
		3 KM8-M8-GSGD-... (pre-assembled connecting cable)	Socket, M8, 3-pin
		3 NEBU-...-M8G3 (modular system for choice of connecting cables)	Socket, M5, 3-pin
			Socket, M8, 3-pin
Socket, M8, 4-pin			
			Socket, M12, 5-pin
			Open cable end

Terminal CPX

Key features – Electrical components

Electrical connection – Connection block

CPX-AB-8-M8X2-4POL with M8-4POL connection

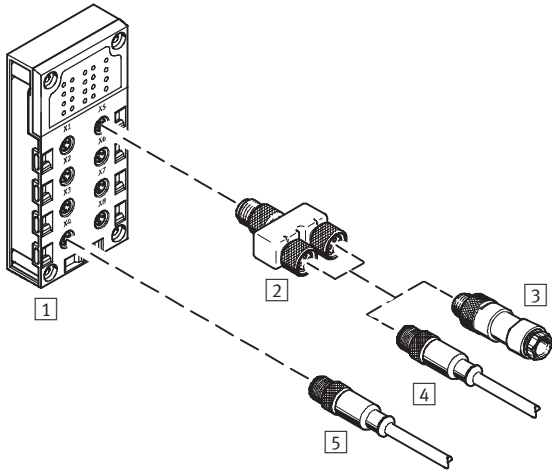

- Compact for pre-assembled individual connection
- 8 sockets
- 4-pin design for connection of 2 channels per socket

Combination of connection block with electrical connection technology

Connection block	Connection technology	Plug connector/ connecting cable	Selectable connection technology	Plug connector/ connecting cable	Selectable connection technology
1 CPX-AB-8-M8X2-4POL	Socket, M8, 4-pin	4 NEBU-...-M8G4 (modular system for choice of connecting cables)	Socket, M5, 3-pin	–	–
			Socket, M8, 3-pin	–	–
			Socket, M8, 4-pin	–	–
			Socket, M12, 5-pin	–	–
			Open cable end	–	–
		2 NEDU-M8D3-M8T4 (T-adaptor)	1x plug M8, 4-pin to	3 SEA-GS-M8	Solderable lugs
			2x socket M8, 3-pin	3 SEA-3GS-M8-S	Screw terminals
				4 KM8-M8-GSGD-... (pre-assembled connecting cable)	Socket, M8, 3-pin
				4 NEBU-...-M8G3 (modular system for choice of connecting cables)	Socket, M5, 3-pin
					Socket, M8, 3-pin
		Socket, M8, 4-pin			
		Socket, M12, 5-pin			
		Open cable end			

Terminal CPX

Key features – Electrical components

FESTO

Electrical connection – Connection block

CPX-AB-4-M12x2-5POL and CPX-AB-4-M12x2-5POL-R with M12-5POL connection

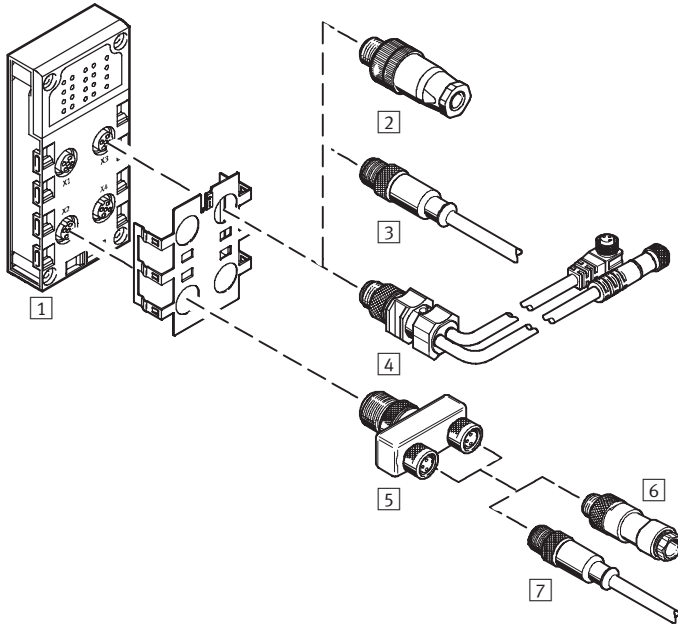

- Sturdy and pre-assembled with 2 channels per socket
- 4 sockets
- 5-pin design per socket
- Version ...-R with quick-lock technology and metal thread for screening
- With two channels per socket, the corresponding input signals can be easily connected via a T-adaptor and conventional cable with M8 connection

Terminal CPX

Key features – Electrical components

Combination of connection block with electrical connection technology							
Connection block	Connection technology	Plug connector/connecting cable	Connection technology	Plug connector/connecting cable	Connection technology		
1 CPX-AB-4-M12x2-5POL CPX-AB-4-M12x2-5POL-R	Socket, M12, 5-pin	2 SEA-GS-7	Screw terminals	-	-		
		2 SEA-4GS-7-2,5	Screw terminals	-	-		
		2 SEA-GS-9	Screw terminals	-	-		
		2 SEA-M12-5GS-PG7	Screw terminals	-	-		
		2 SEA-GS-11-DUO	Screw terminals, for two cables	-	-		
		2 SEA-5GS-11-DUO	Screw terminals, for two cables	-	-		
		3 KM12-M12-... (pre-assembled connecting cable)	Socket, M12, 4-pin	-	-		
		3 NEBU-...-M12G4	Socket, M5, 4-pin	-	-		
		3 NEBU-...-M12G5	Socket, M8, 4-pin	-	-		
			Socket, M12, 5-pin	-	-		
			Open cable end	-	-		
		4 KM12-DUO-M8-... (pre-assembled connecting cable)	Plug M12, 4-pin to 2x socket M8, 3-pin	6 SEA-GS-M8	Solderable lugs		
		5 NEDU-M8D3-M12T4 (T-adapter)		6 SEA-3GS-M8-S	Screw terminals		
		5 NEDU-M12D5-M12T4 (T-adapter)				7 KM8-M8-GSGD-... (pre-assembled connecting cable)	Socket, M8, 3-pin
						7 NEBU-...-M8G3 (modular system for choice of connecting cables)	Socket, M5, 3-pin
							Socket, M8, 3-pin
							Socket, M8, 4-pin
							Socket, M12, 5-pin
							Open cable end
						6 SEA-GS-7	Screw terminals
						6 SEA-4GS-7-2,5	Screw terminals
						6 SEA-GS-9	Screw terminals
						6 SEA-M12-5GS-PG7	Screw terminals
		6 SEA-GS-11-DUO	Screw terminals, for two cables				
		6 SEA-5GS-11-DUO	Screw terminals, for two cables				
		7 KM12-M12-... (pre-assembled connecting cable)	Socket, M12, 4-pin				
		7 NEBU-...-M12G4 (modular system for choice of connecting cables)	Socket, M5, 4-pin				
7 NEBU-...-M12G5 (modular system for choice of connecting cables)	Socket, M8, 4-pin						
	Socket, M12, 5-pin						
	Open cable end						

Terminal CPX

Key features – Electrical components

FESTO

Electrical connection – Connection block (metal version)

CPX-M-4-M12x2-5POL with M12-5POL connection

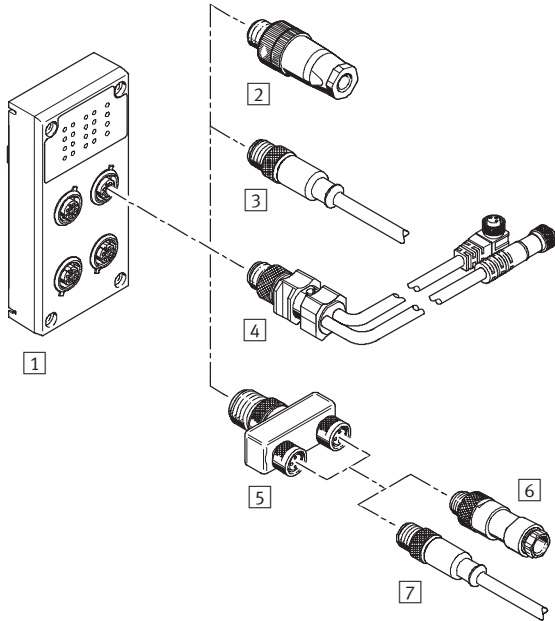

- Sturdy and for pre-assembly with 2 channels per socket
- 4 sockets
- 5-pin design per socket
- With two channels per socket, the corresponding input signals can be easily connected via a T-adaptor and conventional cable with M8 connection

CPX-M-8-M12x2-5POL with M12-5POL connection

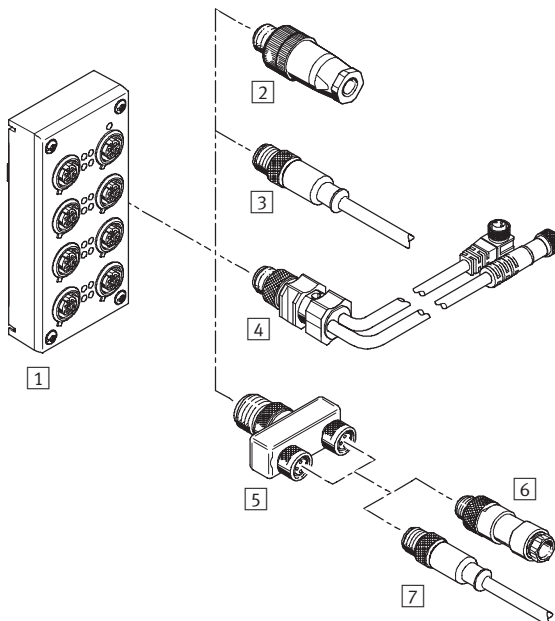

- Sturdy and for pre-assembly with 2 channels per socket
- 8 sockets
- 5-pin design per socket
- With two channels per socket, the corresponding input signals can be easily connected via a T-adaptor and conventional cable with M8 connection

Terminal CPX

Key features – Electrical components

Combination of connection block with electrical connection technology							
Connection block	Connection technology	Plug connector/connecting cable	Connection technology	Plug connector/connecting cable	Connection technology		
1 CPX-M-4-M12x2-5POL CPX-M-8-M12x2-5POL	Socket, M12, 5-pin	2 SEA-GS-7	Screw terminals	-	-		
		2 SEA-4GS-7-2,5	Screw terminals	-	-		
		2 SEA-GS-9	Screw terminals	-	-		
		2 SEA-M12-5GS-PG7	Screw terminals	-	-		
		2 SEA-GS-11-DUO	Screw terminals, for two cables	-	-		
		2 SEA-5GS-11-DUO	Screw terminals, for two cables	-	-		
		3 KM12-M12-... (pre-assembled connecting cable)	Socket, M12, 4-pin	-	-		
		3 NEBU-...-M12G4	Socket, M5, 4-pin	-	-		
		3 NEBU-...-M12G5	Socket, M8, 4-pin	-	-		
			Socket, M12, 5-pin	-	-		
			Open cable end	-	-		
		4 KM12-DUO-M8-... (pre-assembled connecting cable)	Plug M12, 4-pin to 2x socket M8, 3-pin	6 SEA-GS-M8	Solderable lugs		
		5 NEDU-M8D3-M12T4 (T-adapter)		6 SEA-3GS-M8-S	Screw terminals		
		5 NEDU-M12D5-M12T4 (T-adapter)				7 KM8-M8-GSGD-... (pre-assembled connecting cable)	Socket, M8, 3-pin
						7 NEBU-...-M8G3 (modular system for choice of connecting cables)	Socket, M5, 3-pin
							Socket, M8, 3-pin
							Socket, M8, 4-pin
							Socket, M12, 5-pin
							Open cable end
						6 SEA-GS-7	Screw terminals
						6 SEA-4GS-7-2,5	Screw terminals
						6 SEA-GS-9	Screw terminals
						6 SEA-M12-5GS-PG7	Screw terminals
						6 SEA-GS-11-DUO	Screw terminals, for two cables
						6 SEA-5GS-11-DUO	Screw terminals, for two cables
		7 KM12-M12-... (pre-assembled connecting cable)	Socket, M12, 4-pin				
		7 NEBU-...-M12G4 (modular system for choice of connecting cables)	Socket, M5, 4-pin				
		7 NEBU-...-M12G5 (modular system for choice of connecting cables)	Socket, M8, 4-pin				
Socket, M12, 5-pin							
Open cable end							

Terminal CPX

Key features – Electrical components

Electrical connection – Connection block

CPX-AB-4-M12-8POL with M12-8POL connection

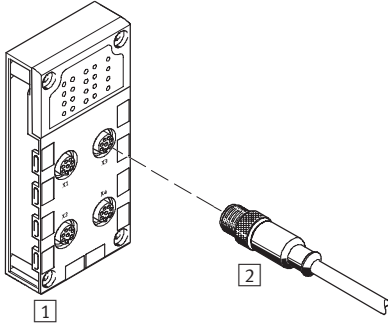

- Connection to cylinder-valve combinations with max. 3 inputs and 2 outputs
- 4 sockets
- 8-pin design per socket

Combination of connection block with electrical connection technology

Connection block	Connection technology	Plug connector/connecting cable	Selectable connection technology
1 CPX-AB-4-M12-8POL	Socket, M12, 8-pin	2 KM12-8GD8GS-2-PU (pre-assembled connecting cable)	Socket, M12, 8-pin

CPX-AB-8-KL-4POL with spring loaded terminal connection

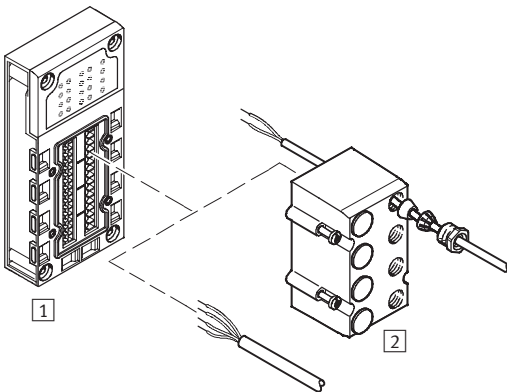

- Fast connection technology for use in control cabinets
- 32 spring-loaded terminals
- 4 terminals per channel
- Wire cross sections 0.05 ... 1.5 mm²
- Optional cover with fittings for IP65/67 connection
 - 8 through-holes M9
 - 1 through-hole M16
 - Blanking plug
 - For I/O distributors, consoles or individual sensors/actuators

Combination of connection block with electrical connection technology

Connection block	Connection technology	Plug connector/connecting cable	Selectable connection technology
1 CPX-AB-8-KL-4POL	spring loaded terminals, 32-pin	2 AK-8KL (cover)	–

Terminal CPX

Key features – Electrical components

Electrical connection – Connection block

CPX-AB-1-SUB-BU-25POL with Sub-D connection

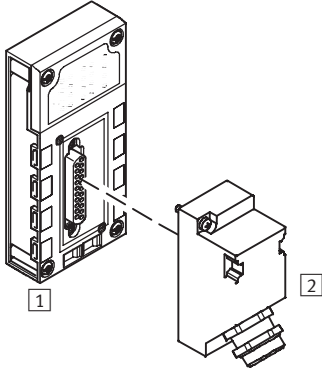

- Multi-pin plug connection for I/O distributor or console
- One socket
- 25-pin design

Combination of connection block with electrical connection technology

Connection block	Connection technology	Plug connector/connecting cable	Selectable connection technology
1 CPX-AB-1-SUB-BU-25POL	Socket, Sub-D, 25-pin	2 SD-SUB-D-ST25	Crimp contacts

CPX-AB-4-HARx2-4POL with HARAX connection

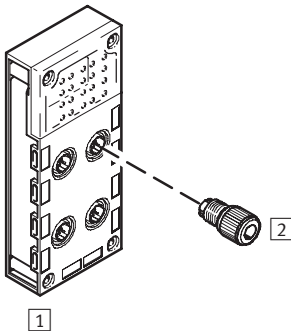

- Sturdy, fast connection technology for individual connections
- 4 sockets
- 4-pin design per socket

Combination of connection block with electrical connection technology

Connection block	Connection technology	Plug connector/connecting cable	Selectable connection technology
1 CPX-AB-4-HAR-4POL	Socket, HARAX, 4-pin	2 SEA-GS-HAR-4POL	Insulation displacement connectors

Terminal CPX

Key features – Mounting types

Mounting options

Valve terminals with CPX terminal support different mounting methods for direct machine mounting with high

protection and control cabinet installation.

H-rail mounting

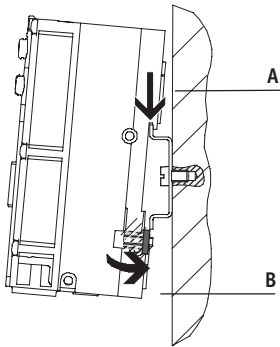

The H-rail mounting is formed in the reverse profile of the CPX interlinking blocks. The CPX terminal can be attached to the H-rail using the H-rail mounting kit.

The CPX terminal is attached to the H-rail as follows (see arrow A).

It is first swivelled on the H-rail and then secured in place with the clamping component (see arrow B). The optional earthing plate allows a convenient working connection to be established to the machine potential/earth.

The following mounting kit is required for H-rail mounting:

- CPA-BG-NRH

This enables mounting of the CPX on H-rails to EN 60715.

An additional mounting kit is required for combination with valve terminals.

Wall mounting for plastic version

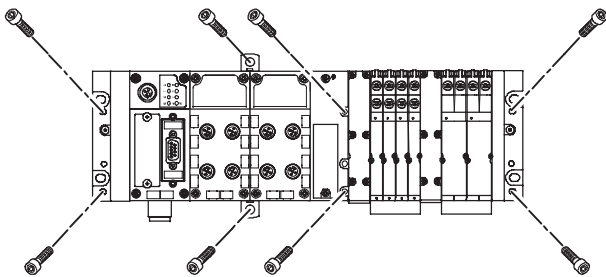

The end plates of the CPX terminal, the valve terminal and the pneumatic interface include mounting holes for wall mounting. For longer valve terminals, there are additional mountings for the CPX terminal. These mountings vary depending on the CPX terminal version (plastic or metal).

Wall mounting for metal version

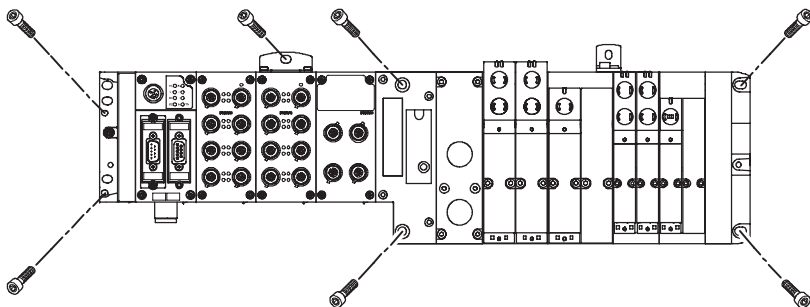

Terminal CPX

Key features – Mounting types

CPX terminal in plastic version

Additional mountings

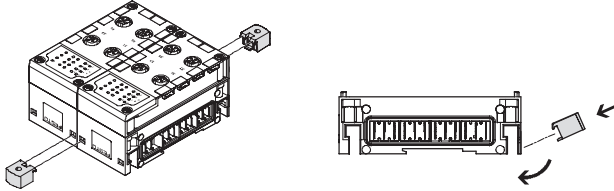

For longer valve terminals, there are additional mountings for the CPX terminal that can be fitted between two modules.



Note

In the case of CPX terminals with 4 and more interlinking blocks, additional mountings of type CPX-BG-RW-... must be used approx. every 100 or 150 mm. These are supplied pre-assembled.

Linking with tie rods

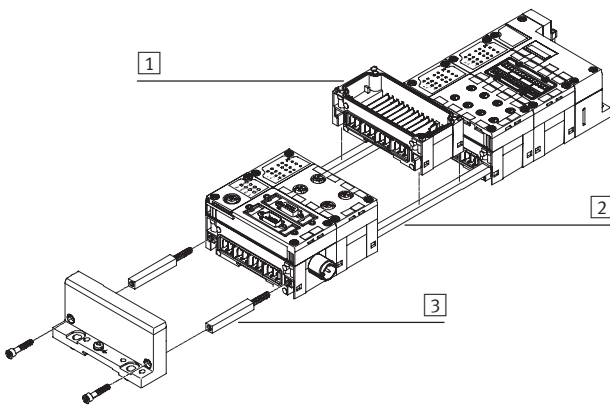

The mechanical connection between the CPX modules is created using special tie rods [2]. Two screws in the end plates are all that are needed to assemble the entire unit. The tie rod ensures that the unit withstands high mechanical loads and is therefore the “mechanical backbone” of the CPX terminal.

The open design allows interlinking blocks [1] to be replaced in the assembled state.

The tie rod expansion kit [3] enables an extra module to be added to the CPX terminal.

CPX terminal in metal version

Additional mounting parts

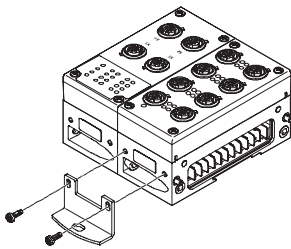

For longer valve terminals, there are additional mounting brackets for the CPX terminal that can be fitted to the interlinking blocks.



Note

In the case of CPX terminals with 4 and more interlinking blocks, additional mounting brackets of type CPX-M-BG-RW-... must be used approx. every 100 or 150 mm. These are supplied pre-assembled.

Linking with screws

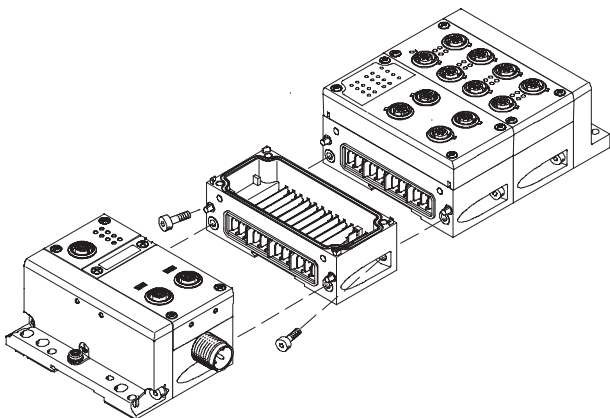

The mechanical connection between the CPX modules is created using a splayed screw connection. The CPX terminal is thus flexibly expandable at any time.

Terminal CPX

Key features – Power supply

Power supply concept

General information

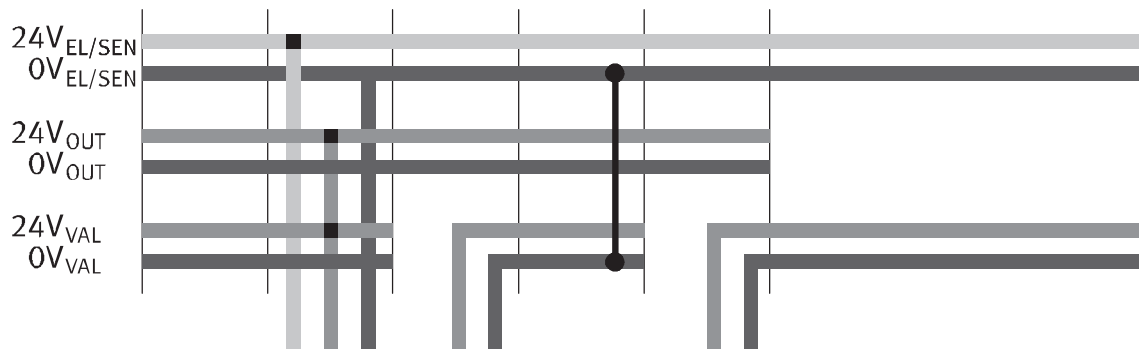
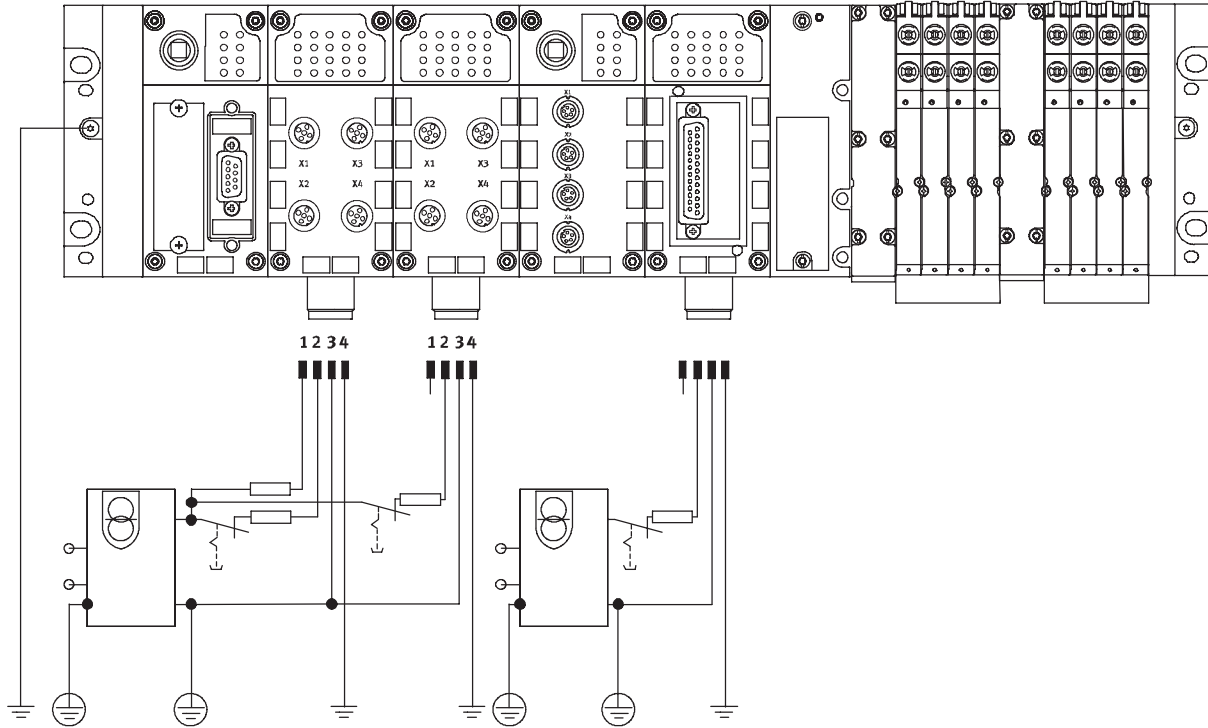

The use of decentralised devices on the fieldbus – particularly with high protection for direct machine mounting – demands a flexible power supply

concept. A valve terminal with CPX can be supplied with all voltages using a single socket.

A distinction is made between supply for

- electronics plus sensors
- valves plus actuators

in this case. The following connecting thread can be selected:

- M18
- 7/8"

Interlinking blocks

Interlinking blocks represent the backbone of the CPX terminal with all supply lines. They provide the power supply for the modules used on them

as well as the bus connection. Many applications require the CPX terminal to be segmented into voltage zones. This applies in particular to the

separate disconnection of solenoid coils and outputs. The interlinking blocks provide either a space-saving central power supply

for the entire CPX terminal or galvanically isolated, all-pin disconnectable potential groups/voltage segments.

Terminal CPX

Key features – Power supply

Interlinking blocks

With system supply

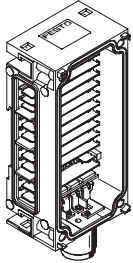

Type – plastic version

- CPX-GE-EV-S
- CPX-GE-EV-S-7/8-5POL
- CPX-GE-EV-S-7/8-4POL

Connection technology

- M18
- 7/8" 5-pin
- 7/8" 4-pin

Power supply

- For CPX terminal modules and connected sensors
- For valves that are connected to the CPX terminal via a pneumatic interface
- For actuators that are connected to CPX terminal output modules

Type – metal version

- CPX-M-GE-EV-S-7/8-5POL
- CPX-M-GE-EV-S-PP-5POL

Connection technology

- 7/8" 5-pin
- AIDA push-pull 5-pin

Without power supply

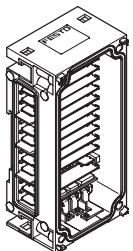

Type – plastic version

- CPX-GE-EV

–

–

Type – metal version

- CPX-M-GE-EV

–

With additional power supply for outputs

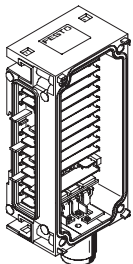

Type – plastic version

- CPX-GE-EV-Z
- CPX-GE-EV-Z-7/8-5POL
- CPX-GE-EV-Z-7/8-4POL

Connection technology

- M18
- 7/8" 5-pin
- 7/8" 4-pin

Power supply

- For actuators that are connected to CPX terminal output modules

Type – metal version

- CPX-M-GE-EV-Z-7/8-5POL
- CPX-M-GE-EV-Z-PP-5POL

Connection technology

- 7/8" 5-pin
- AIDA push-pull 5-pin

With additional power supply for valves

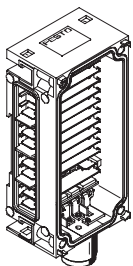

Type – plastic version

- CPX-GE-EV-V
- CPX-GE-EV-V-7/8-4POL

Connection technology

- M18
- 7/8" 4-pin

Power supply

- For valves that are connected to the CPX terminal via a pneumatic interface

 Note

For 7/8":

- Commercially available accessories are often limited to max. 8 A

 Note

Valve terminal type 32 MPA has either a 7/8", 5-pin, 7/8", 4-pin or M18, 3-pin power supply for one or more voltage zones of the valves.

Galvanically isolated, all-pin disconnectable with voltage monitoring in the following MPA module.

Terminal CPX

Key features – Diagnostics

Diagnostics

System performance

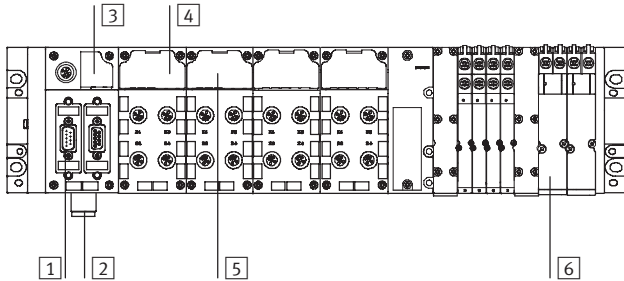

- 1 Diagnostics via bus interface
- 2 Undervoltage monitor
- 3 Diagnostic overview LED
 - Fieldbus status
 - CPX status
- 4 Status and diagnostic LED for module and I/O channels
- 5 Module and channel-specific diagnostics
- 6 Valve-specific diagnostics for module and solenoid coils

Detailed diagnostic functions are needed in order to quickly locate the causes of errors in the electrical installation and therefore reduce downtimes in production plants. A basic distinction is made between on-the-spot diagnostics using LEDs or handheld control unit and diagnostics using a bus interface.

The CPX terminal supports on-the-spot diagnostics via a row of LEDs. This is separate from the connection area and therefore provides good visual access to status and diagnostic information.

Module- and channel-specific diagnostics is supported, for example

- Undervoltage identification for the outputs and valves
- Short circuit detection for sensors, outputs and valves
- Open-circuit detection for a missing solenoid coil
- Storage of the last 40 causes of errors with error start and error end

The diagnostic messages can be read via bus interface in the master controller and visualised for the centralised recording and evaluation of error causes. This is done using the individual fieldbus-specific channels. The CPX-FEC also offers the option of access via the integrated Ethernet interface (remote maintenance via PC/web applications).

Overview of LEDs on the bus node

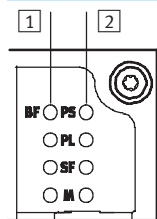

- 1 Fieldbus-specific LEDs

On each bus node, a maximum of 4 fieldbus-specific LEDs display the fieldbus communication status of the CPX terminal with the master controller.
- 2 CPX-specific LEDs

A further 4 CPX-specific LEDs provide non-fieldbus-specific information about the status of the CPX terminal, for example

 - Power system
 - Power load
 - System errors
 - Modification parameters

Status of input/output module and diagnostic LEDs

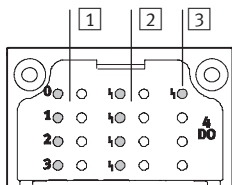

- 1 Status LEDs for inputs and outputs

Each input and output channel is assigned a status LED.
- 2 Channel-oriented diagnostic LED

Depending on the module design, a further diagnostic LED is available for each I/O channel.
- 3 Central diagnostic LED

An LED displays an overall diagnostic for each module.

Terminal CPX

Key features – Parameterisation

Diagnostics

Display on handheld control unit

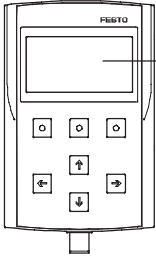

- 1 LCD graphical display for plain text diagnostics on the spot
 - Location and type of fault
 - No programming

Display on PC

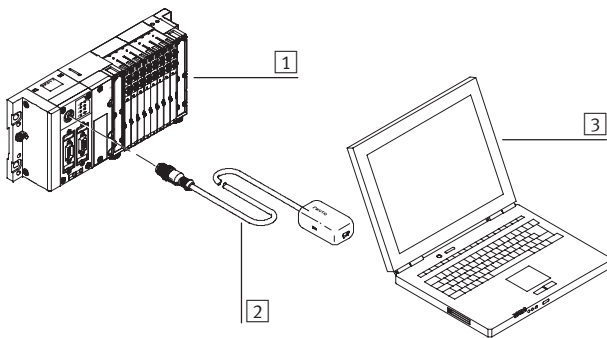

- 1 CPX terminal with valve terminal
- 2 Adapter cable for USB diagnostic interface
- 3 Laptop/handheld device with USB interface and installed FMT soft
 - Fault location and type
 - Without programming
 - Saving the configuration
 - Producing screen shots

Display on Web Monitor



CPX Web Monitor overview



Analogue module, channel-oriented diagnostics

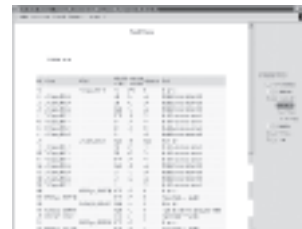

Error memory (fault trace)

The Web Monitor displays all static and dynamic information on a CPX terminal via Ethernet online – in the web browser of the PC. This facility is optionally available via intranet and Internet. Everything is plug & work – without the need for web programming such as HTML or JAVA.

Parameterisation

Changes to the application are often required during commissioning. Thanks to the parameterisable characteristics of CPX modules, functions can be very easily changed by means of configuration software. This reduces

the number of modules needed and, consequently, the amount of storage space required. It is therefore possible for example to reduce the input debounce time for an input module – normally 3 ms – to

0.1 ms on a “fast” input module for faster processes, or to set the response of a valve following a fieldbus failure. Depending on the modules used, parameterisation can be performed

via the following interfaces:

- Ethernet
- Fieldbus
- FEC direct interface (programming interface)
- Handheld control unit CPX-MMI

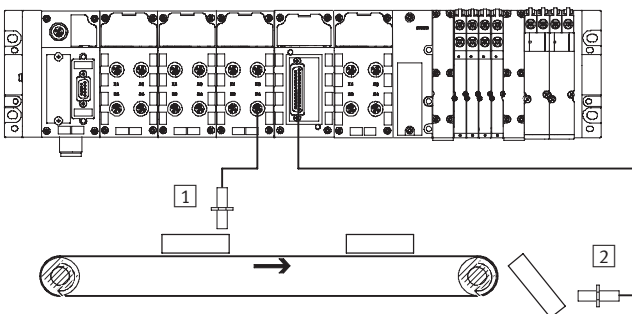

- 1 Input debounce time 3 ms
- 2 Input debounce time 0.1 ms

Terminal CPX

Key features – Addressing

Addressing

General information on addressing

The various CPX modules occupy a different number of I/O addresses within the CPX system. The maximum address space for bus nodes depends on the performance of the fieldbus system.

Maximum system extension:

- 1 bus node or control block
- 9 I/O modules
- 1 pneumatic interface (e.g. pneumatic interface MPA with up to 16 MPA manifold sub-bases)

The maximum system extension can be limited in individual cases by exceeding the address space.



Note

Please refer to the detailed description of the configuration/addressing rules in the technical data for CPX bus nodes.

Overview – Allocated addresses for CPX modules

	Inputs [bit]	Outputs [bit]
CPX-CMXX	2 x 64	2 x 64
CPX-4DE	4	–
CPX-8DE	8	–
CPX-16DE	16	–
CPX-M-16DE-D	16	–
CPX-8DE-D	8	–
CPX-8NDE	8	–
CPX-4DA	–	4
CPX-8DA	–	8
CPX-8DA-H	–	8
CPX-8DE-8DA	8	8
CPX-2AE	2 x 16	–
CPX-4AE-I	4 x 16	–
CPX-4AE-T	4 x 16	–
CPX-4AE-TC	4 x 16	–
CPX-2AA	–	2 x 16
VABA-S6-1-X1	–	8, 16, 24, 32 ¹⁾
VABA-S6-1-X2	–	8, 16, 24, 32 ¹⁾
CPX-GP-CPA-10	–	8, 16, 24 ¹⁾
CPX-GP-CPA-14	–	8, 16, 24 ¹⁾
CPX-GP-03-4,0	–	8, 16, 24, 32 ¹⁾
CPX-M-GP-03-4,0	–	8, 16, 24, 32 ¹⁾
VMPA1-FB-EMS-8	–	8
VMPA1-FB-EMG-8	–	8
VMPA2-FB-EMS-4	–	4
VMPA2-FB-EMG-4	–	4
VMPA1-FB-EMS-D2-8	–	8
VMPA1-FB-EMG-D2-8	–	8
VMPA2-FB-EMS-D2-4	–	4
VMPA2-FB-EMG-D2-4	–	4
VMPA-FB-PS-1	16	–
VMPA-FB-PS-3/5	16	–
VMPA-FB-PS-P1	16	–
VMPA-FB-EMG-P1	16	16

1) Depends on the DIL switch setting on the pneumatic interface

Terminal CPX

Key features – Addressing

Overview – Address space for CPX bus node and control block							
	Protocol	Max. total		Max. digital		Max. analogue	
		Inputs	Outputs	Inputs	Outputs	Inputs	Outputs
CPX-FEC	<ul style="list-style-type: none"> • TCP/IP • EasyIP • Modbus TCP • HTTP 	512 bit	512 bit	512 DE	512 DO	32 AI	18 AO
CPX-FB6	Interbus	96 bit	96 bit	96 DE	96 DO	6 AI	6 AO
CPX-FB11	DeviceNet	512 bit	512 bit	512 DE	512 DO	32 AI	18 AO
CPX-FB13	Profibus	512 bit	512 bit	512 DE	512 DO	32 AI	18 AO
CPX-FB14	CANopen	192 bit	192 bit	64 DI (+ 64 DI)	64 DO (+ 64 DO)	8 AI (+ 8 AI)	8 AO (+ 8 AO)
CPX-FB23	CC-Link	–	–	64 DE	64 DO	16 AI	16 AO
CPX-FB32	Ethernet/IP	512 bit	512 bit	512 DE	512 DO	32 AI	18 AO
CPX-FB33	PROFINET IO	512 bit	512 bit	512 DE	512 DO	32 AI	18 AO
CPX-FB34	PROFINET IO	512 bit	512 bit	512 DE	512 DO	32 AI	18 AO
CPX-FB38	EtherCAT	512 bit	512 bit	512 DE	512 DO	32 AI	18 AO

 Note

With module selection and the maximum number of modules, the bandwidth of the fieldbus nodes can be restricted.

Example – CPX-FB6 (Interbus)			
	Digital inputs	Digital outputs	Remarks
3x CPX-8DE	24	–	<ul style="list-style-type: none"> • The address space is occupied with 7 CPX I/O modules plus pneumatic interface • No additional modules can be configured
1x CPX-8DE-8DA	8	8	
2x CPX-2AE	64	–	
1x CPX-2AA	–	32	
3x VMPA1	–	24	
Allocated address space	96	96	

DI = Digital inputs (1 bit)

DO = Digital outputs (1 bit)

AO = Analogue outputs (16 bit)

AI = Analogue inputs (16 bit)

Terminal CPX

Key features – Type codes for connection technology

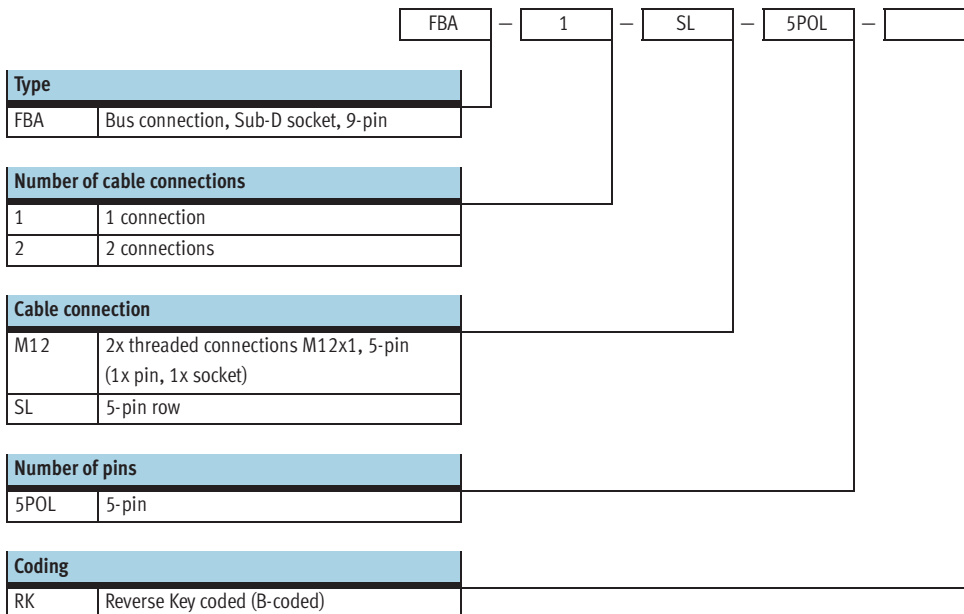
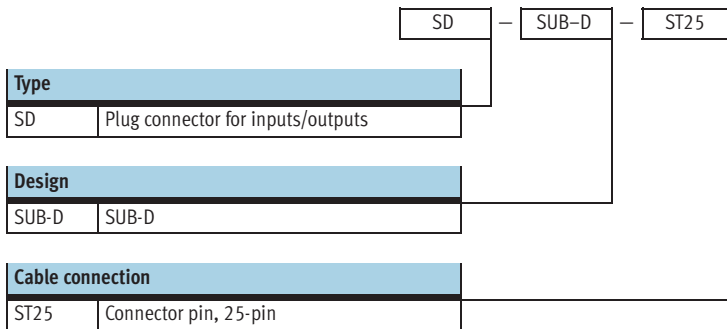
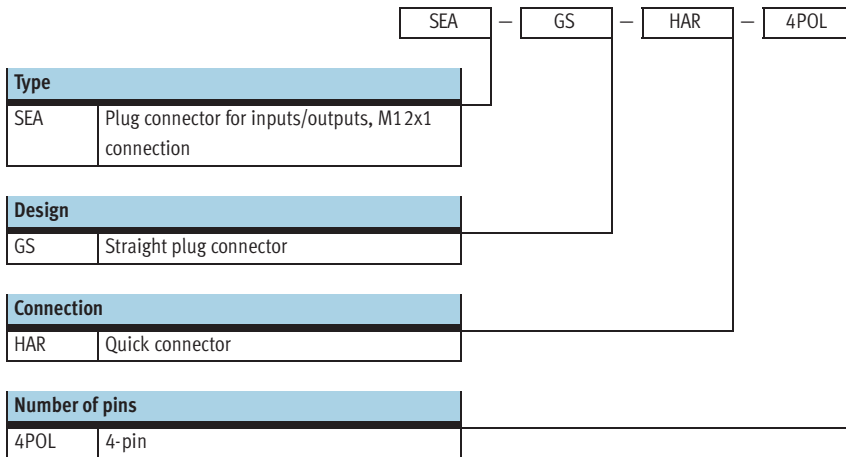

Terminal CPX

Key features – Type codes for connection technology

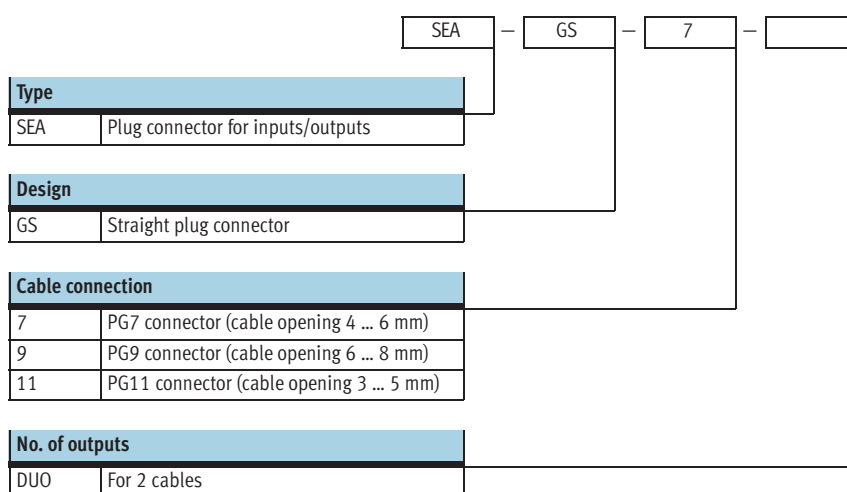
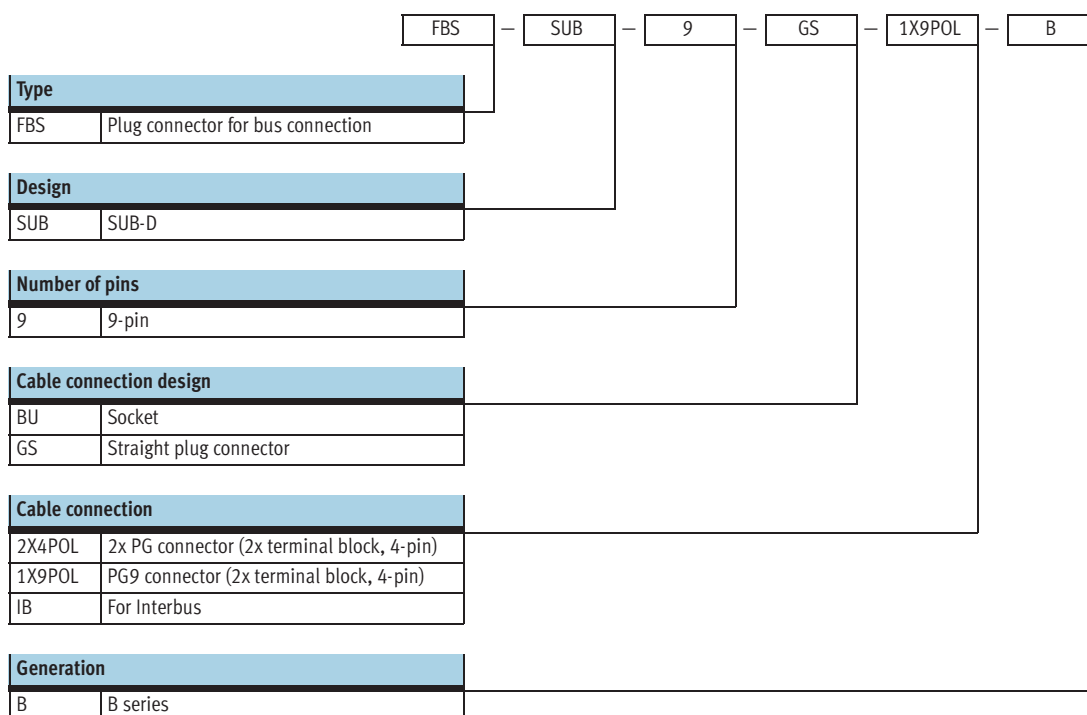

Terminal CPX

Key features – Type codes for connection technology

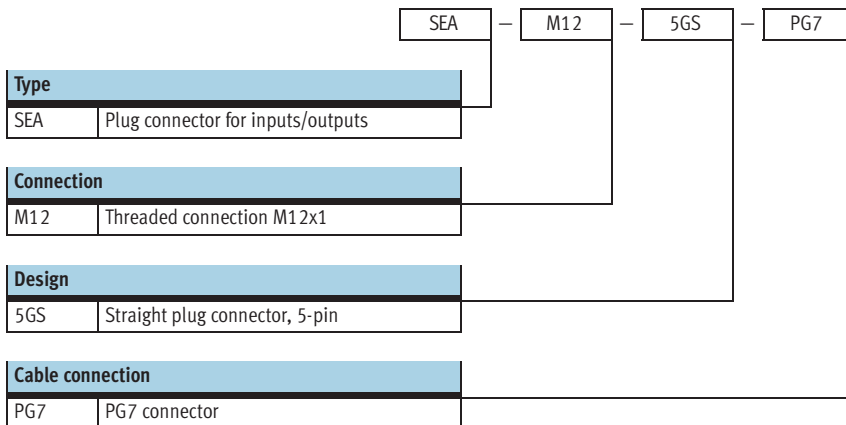
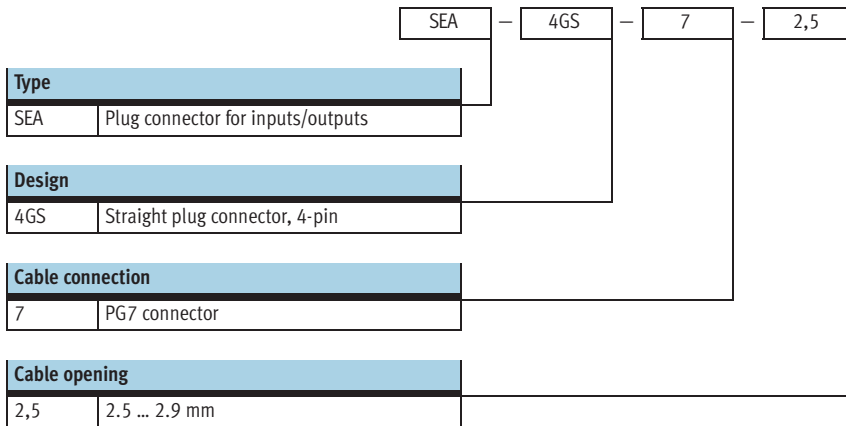
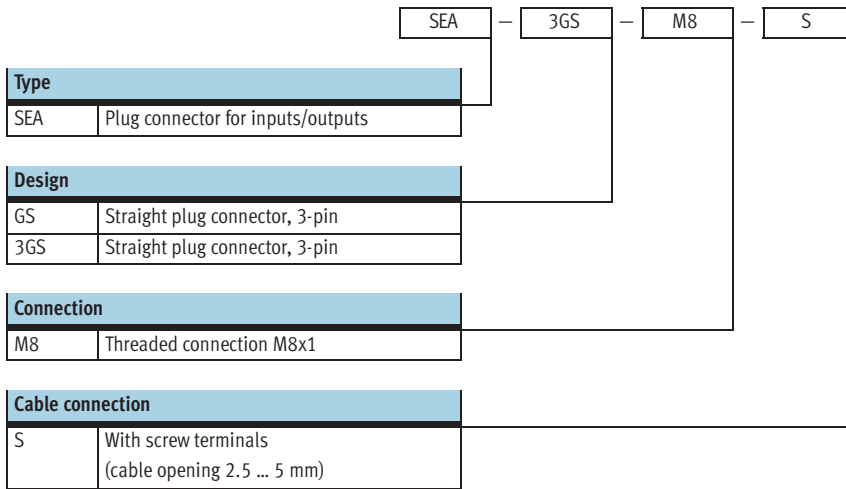

Terminal CPX

Key features – Type codes for connection technology

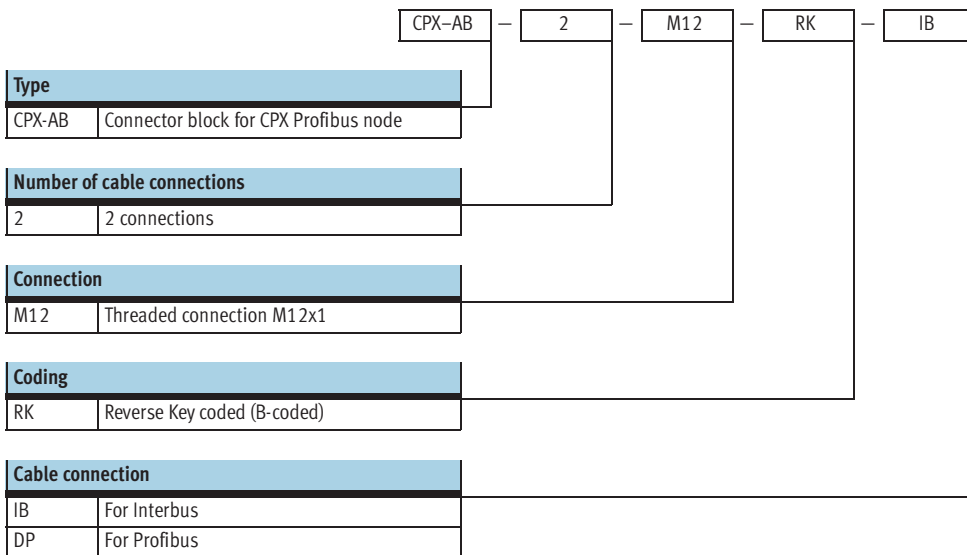
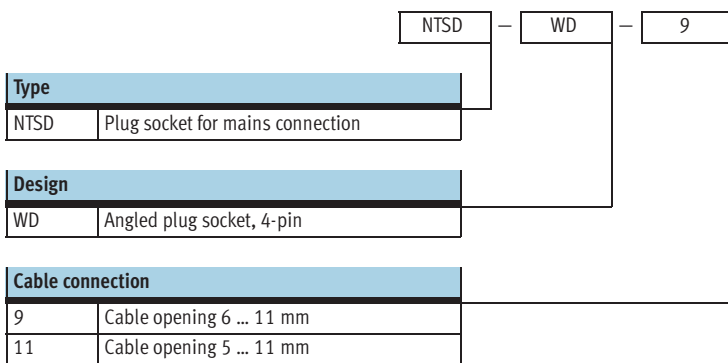
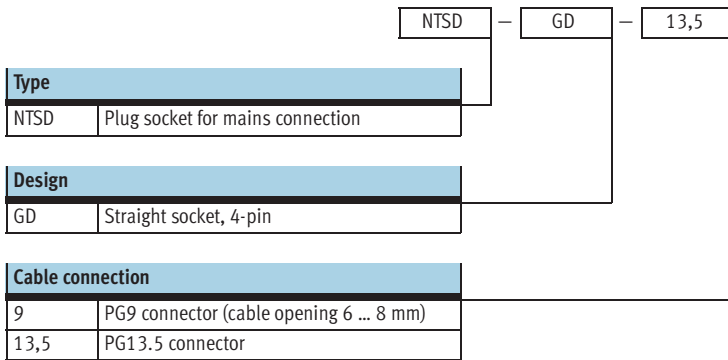

Terminal CPX

Key features – Type codes for connection technology

FBS		RJ45				GS	
Type							
FBS	Fieldbus plug						
Connection							
RJ45	RJ45 push-in connector						
Number of pins							
8	8-pin						
PP	Push Pull						
Design							
GS	Straight plug connector						

NECU		M		S		D12		G		4				ET	
Type															
NECU	Plug connector														
Design															
-	Standard														
M	Primarily from metal														
Type of connection															
-	Socket														
S	Plug														
Connection															
D12	M12, D-coded														
G78	7/8" round plug connector														
Design															
G	Straight														
Number of pins															
4	4-pin														
5	5-pin														
Cable connection															
-	Standard														
C2	Cable terminal														
Bus protocol															
-	Standard														
ET	Ethernet														

Terminal CPX

Key features – Type codes for connection technology

		NEBU	–	M12	W	5	P	–	K	–	2.5	–		–	LE		3	
Function																		
NEBU	Connecting cable																	
Connection, left																		
M5	Socket with connecting thread																	
M8	Socket with connecting thread																	
M12	Socket with connecting thread, A-coded																	
Socket design																		
G	Straight																	
W	Angled																	
Number of pins/wires (left)																		
3	3-pin (suitable for M8 plug)																	
4	4-pin (suitable for M8 plug)																	
5	5-pin (suitable for 3-, 4- and 5-pin M12 plug)																	
Display																		
–	Without LED, DC (standard)																	
P	LED, PNP																	
N	LED, NPN																	
Cable attribute																		
K	Standard																	
E	Suitable for chain link trunking																	
R	Suitable for robot applications																	
Cable length																		
0.1 ... 25	0.1 ... 25 m																	
Alternative wire cross section																		
–	0.25 mm ² (standard)																	
Q3	0.14 mm ²																	
Cable designation																		
–	With inscription label holder (standard)																	
N	Without inscription label holder																	
Connection, right																		
LE	Open end																	
M8	Socket with connecting thread																	
M12	Socket with connecting thread, A-coded																	
Plug design																		
G	Straight																	
W	Angled																	
Number of pins/wires (right)																		
3	3-pin (suitable for M8/M12 socket)																	
4	4-pin (suitable for M8/M12 socket)																	
5	5-pin (suitable for M12 socket)																	

Terminal CPX

Key features – Type codes for connection technology

NEDU		-			M12	D	5	-			M12	T	4
Function													
NEDU		Push-in T-connector											
Connection, left													
M8		M8x1											
M12		M12x1, A-coded											
Socket design													
D		Multiple socket											
Number of pins/wires													
3		3-pin											
5		5-pin											
Connection, right													
M8		M8x1											
M12		M12x1, A-coded											
Plug design													
T		T-piece											
Number of pins/wires													
4		4-pin											

Terminal CPX

Technical data

-  - Module width
50 mm



-  - Note
The data given here applies to the CPX system. If components that conform to lower values are used in the system, the specification for the entire system is reduced to the values of those components used.

Example
Protection class IP65/IP67 applies only to the fully assembled system with fitted plugs or covers (which must also conform to IP65/67). If components with a lower protection class are used, the protection level of the entire system is reduced to the protection class of the component with the lowest protection level, e.g. Cage-Clamp connection block with IP20 protection or MPA pneumatics with IP65 protection.

General technical data			
Module No.	197330		
Max. no. of modules ¹⁾	Control block		1
	Bus node		1
	I/O module/CP interface		9
	Multi-axis interface		
Max. no. of modules ¹⁾	Pneumatic interface		1
Max. address capacity	Inputs	[Byte]	64
	Outputs	[Byte]	64
Internal cycle time		[ms]	< 1
Configuration support	Fieldbus-specific		
LED displays	Bus node/control block		Up to 4 LEDs, bus-specific 4 LEDs, CPX-specific • PS = Power system • PL = Power load • SF = System error • M = Modify parameter/forcing active
	I/O modules		Min. one centralised diagnostic LED Channel-oriented status and diagnostic LED, depending on module
	Pneumatic interface		One centralised diagnostic LED Valve status LED on valve
Diagnostics	<ul style="list-style-type: none"> • Channel and module-oriented diagnostics for inputs/outputs and valves • Detection of module undervoltage for the different voltage potential values • Storage of the last 40 errors with timestamp (asynchronous access) 		

¹⁾ A maximum of 11 modules in total can be combined (e.g. 1 control block + 9 I/O modules + 1 pneumatic interface, or 1 control block + 1 bus node + 8 I/O modules + 1 pneumatic interface)

Terminal CPX

Technical data

FESTO

General technical data		
Module No.	197330	
Parameterisation	Module-specific and entire system, for example: <ul style="list-style-type: none"> • Diagnostic behaviour • Condition monitoring • Profile of inputs • Fail-safe response of outputs and valves 	
Commissioning support	Forcing of inputs and outputs	
Protection class to EN 60529	IP65/IP67	
Nominal operating voltage	[V DC]	24
Operating voltage range	[V DC]	18 ... 30
Power supply	Interlinking block with system supply	
	Electronics plus sensors	[A] Max. 16 A (M18 supply), max. 12 A (7/8" supply)
	Actuators plus valves	[A] Max. 16 A (M18 supply), max. 12 A (7/8" supply)
	Additional power supply	
	Actuators	[A] Max. 16 A per M18 supply, max. 12 A per 7/8" supply
	Additional power supply for valves	[A] Max. 16 A per M18 supply
Current consumption	Depending on system configuration	
Power failure bridging (bus electronics only)	[ms]	10
Voltage supply connection	M18, 4-pin	
	7/8" 5-pin	
	7/8" 4-pin	
	AIDA push-pull 5-pin	
Fuse concept	Per module with electronic fuses	
Tests	Vibration test To DIN/IEC 68/EN 60068 Part 2 – 6	<ul style="list-style-type: none"> • For wall mounting: severity level 2 • For H-rail mounting: severity level 1
	Shock test To DIN/IEC 68/EN 60068 Part 2 – 27	<ul style="list-style-type: none"> • For wall mounting: severity level 2 • For H-rail mounting: severity level 1
PWIS classification	Free of paint wetting impairment substances	
Interference immunity	EN 61000-6-2 (industry)	
Interference emission	EN 61000-6-4 (industry)	
Isolation test for galvanically isolated circuits to IEC 1131 Part 2	[V]	500 DC
Galvanic isolation of electrical voltages	[V]	80 DC
Protection against direct and indirect contact	PELV (Protected Extra-Low Voltage)	
Materials	End plates: die-cast aluminium	
Grid dimension	[mm]	50

Operating and environmental conditions		
Module No.	197330	
Ambient temperature	[°C]	-5 ... +50
Storage temperature	[°C]	-20 ... +70
Relative air humidity (non-condensing)	[%]	5 ... 90
Explosion protection class	In accordance with EU explosion protection directive (ATEX)	
ATEX symbol	II 3D Ex tD A 22 IP65 T90°C X II 3D Ex nA II T 4 X	
ATEX ambient temperature	-5 ≤ Ta ≤ +50	
Certification	c UL us - Recognized (OL)	

Terminal CPX

Technical data

FESTO

Weight [g]					
Control block	FEC	140.0	Interlinking block, plastic	Without power supply	80.0
Bus node	FB6	125.0		With system supply	100.0
	FB11	120.0	Interlinking block, metal	Without power supply	162
	FB13	115.0		With system supply	187
	FB14	115.0	Tie rod	1-fold	19.0 ±2.5
	FB23	115.0		2-fold	32.5 ±2.5
	FB32	125.0		3-fold	46.0 ±2.5
	FB33	280.0		4-fold	59.5 ±2.5
	FB34	280.0		5-fold	73.0 ±2.5
FB38	125.0	6-fold		86.5 ±2.5	
I/O module		38.0		7-fold	100.0 ±2.5
CP interface		140	Tie rod	8-fold	113.5 ±2.5
Multi-axis interface	CMXX	155.0		9-fold	127.0 ±2.5
				10-fold	140.5 ±2.5
Pneumatic interface	MPA	238.4	End plate, plastic	Left-hand	77.0
	VTSA/VTSA-F	485.0		Right-hand	70.0
	MIDI/MAXI	390.0	End plate, metal	Left-hand	113
	CPA	150.0		Right-hand	113
Connection block	Plastic	70.0			
	Metal	175.0			

Terminal CPX

Accessories

FESTO

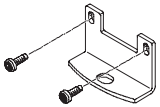
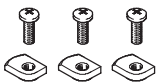
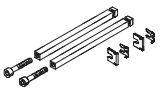
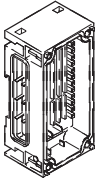
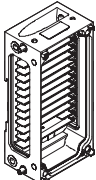
Ordering data – Accessories				
Designation		Type	Part No.	
Mounting set				
	Attachment for wall mounting (for long valve terminals, 10 pieces), version for plastic interlinking plates	CPX-BG-RW-10x	529040	
	Attachment for wall mounting (for long valve terminals, 2 mounting brackets and 4 screws), version for metal interlinking plates	CPX-M-BG-RW-2x	550217	
	Mounting for H-rail	CPX without pneumatic components	CPA-BG-NRH	173498
		CPX-VTSA	CPX-CPA-BG-NRH	526032
		CPX-VTSA-F		
		CPX-MPA		
		CPX-CPA		
		CPX-MIDI	CPX-03-4,0	526033
CPX-MAXI	CPX-03-7,0	526034		
Tie rod				
	Tie rod CPX	Extension 1-fold	CPX-ZA-1-E	525418
		1-fold	CPX-ZA-1	195718
		2-fold	CPX-ZA-2	195720
		3-fold	CPX-ZA-3	195722
		4-fold	CPX-ZA-4	195724
		5-fold	CPX-ZA-5	195726
		6-fold	CPX-ZA-6	195728
		7-fold	CPX-ZA-7	195730
		8-fold	CPX-ZA-8	195732
		9-fold	CPX-ZA-9	195734
		10-fold	CPX-ZA-10	195736
Interlinking block, plastic				
	Without power supply	–	CPX-GE-EV	195742
	With system supply	M18	CPX-GE-EV-S	195746
		7/8" – 5-pin	CPX-GE-EV-S-7/8-5POL	541244
		7/8" – 4-pin	CPX-GE-EV-S-7/8-4POL	541248
	With additional power supply for outputs	M18	CPX-GE-EV-Z	195744
		7/8" – 5-pin	CPX-GE-EV-Z-7/8-5POL	541248
		7/8" – 4-pin	CPX-GE-EV-Z-7/8-4POL	541250
	With additional power supply for valves	M18	CPX-GE-EV-V	533577
7/8" – 4-pin		CPX-GE-EV-V-7/8-4POL	541252	
Interlinking block, metal				
	Without power supply	–	CPX-M-GE-EV	550206
	With system supply	7/8" – 5-pin	CPX-M-GE-EV-S-7/8-5POL	550208
		Push-pull – 5-pin	CPX-M-GE-EV-S-PP-5POL	563057
	With additional power supply for outputs	7/8" – 5-pin	CPX-M-GE-EV-Z-7/8-5POL	550210
		Push-pull – 5-pin	CPX-M-GE-EV-Z-PP-5POL	563058

Terminal CPX

Accessories

FESTO

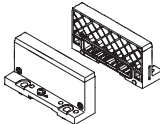
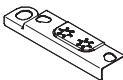
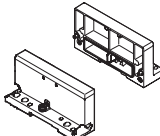
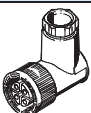
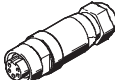
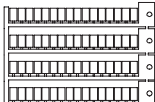
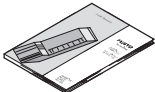
Ordering data – Accessories				
Designation			Type	Part No.
Mounting accessories				
	Screws for mounting the bus node/connection block on the plastic interlinking block	Metal bus node/connection block	CPX-DPT-30X32-S-4X	550218
	Screws for mounting the bus node/connection block on the metal interlinking block	Plastic bus node/connection block	CPX-M-M3x22-4x	550219
		Metal bus node/connection block	CPX-M-M3x22-S-4x	550216
End plates, plastic				
	End plate	Right-hand	CPX-EPR-EV	195714
		Left-hand	CPX-EPL-EV	195716
	Earthing element for right-hand/left-hand end plates	5 pieces	CPX-EPFE-EV	538892
End plates, metal				
	End plate	Right-hand	CPX-M-EPR-EV	550214
		Left-hand	CPX-M-EPL-EV	550212
Power supply				
	Plug socket for mains connection M18, straight, 4-pin	for 1.5 mm ²	NTSD-GD-9	18493
		for 2.5 mm ²	NTSD-GD-13,5	18526
	Plug socket for mains connection M18, angled, 4-pin	for 1.5 mm ²	NTSD-WD-9	18527
		for 2.5 mm ²	NTSD-WD-11	533119
	Plug socket for mains connection 7/8 , straight, 5-pin	0.25 ... 2.0 mm ²	NECU-G78G5-C2	543107
	Plug socket for mains connection 7/8 , straight, 4-pin	0.25 ... 2.0 mm ²	NECU-G78G4-C2	543108
Inscription labels				
	Inscription labels, 6x10, 64 pieces, in frames		IBS-6x10	18576
User documentation				
	CPX System Manual	German	P.BE-CPX-SYS-DE	526445
		English	P.BE-CPX-SYS-EN	526446
		Spanish	P.BE-CPX-SYS-ES	526447
		French	P.BE-CPX-SYS-FR	526448
		Italian	P.BE-CPX-SYS-IT	526449
		Swedish	P.BE-CPX-SYS-SV	526450
		Operator unit CPX-MMI-1	German	P.BE-CPX-MMI-1-DE
	English		P.BE-CPX-MMI-1-EN	534825
	French		P.BE-CPX-MMI-1-FR	534827
	Italian		P.BE-CPX-MMI-1-IT	534828
	Swedish		P.BE-CPX-MMI-1-SV	534829
	Spanish		P.BE-CPX-MMI-1-ES	534826

Terminal CPX

Accessories

User documentation – General information

Comprehensive user documentation is vital for the fast and consistent implementation of fieldbus components.

The documentation provided by Festo contains step-by-step instructions for using CPX terminals:

1. Installation
2. Commissioning and parameterisation
3. Diagnostics

Application-oriented explanations are provided for integration of the CPX terminal in the programming and configuration software of the various controller manufacturers.

Use the order code to select the language you want.

The manual for the configuration you have ordered is supplied automatically.

Manuals are available on the Festo website:

→ www.festo.com



User documentation overview		
Type	Title	Description
Electronics		
P.BE-CPX-SYS...	System description, installing and commissioning	Overview of the design, components and mode of operation of the CPX terminal; installation and commissioning instructions as well as basic principles of parameterisation.
P.BE-CPX-EA...	CPX-EA modules, digital	Connection technology and assembly, installation and commissioning instructions for digital input and output modules of type CPX... as well as CPA, MIDI/MAXI, VTSA/VTSA-F and MPA pneumatic interface.
P.BE-CPX-AX...	CPX-EA modules, analogue	Connection technology and assembly, installation and commissioning instructions for digital input and output modules of type CPX... as well as pressure sensors and proportional pressure regulators.
P.BE-CPX-CP...	CPX CP interface	Instructions on assembly, installation, commissioning and diagnostics of the CP interface.
P.BE-CPX-CMXX...	CPX multi-axis interface	Instructions on assembly, installation, commissioning and diagnostics of the CPX multi-axis interface (CMXX).
P.BE-CPX-FB...	CPX fieldbus node	Instructions on assembly, installation, commissioning and diagnostics of the relevant bus nodes.
P.BE-CPX-PNIO...	CPX fieldbus node for Profinet	Instructions on assembly, installation, commissioning and diagnostics of the relevant bus nodes.
P.BE-CPX-FEC...	CPX control block	Instructions on assembly, installation, commissioning and diagnostics of the relevant control block.
P.BE-CPX-MMI-1-...	Universal handheld type CPX-MMI-1	Instructions on assembly, installation, commissioning and diagnostics of the CPX operator unit.

Terminal CPX

Accessories



User documentation overview		
Type	Title	Description
Pneumatics		
P.BE-VTSA-44-...	Valve terminals with VTSA and VTSA-F pneumatics	Instructions on assembly, installation, commissioning and diagnostics of the VTSA and VTSA-F pneumatic components.
P.BE-CPA-...	Valve terminals with CPA pneumatics	Instructions on assembly, installation, commissioning and diagnostics of the CPA pneumatic components.
P.BE-Midi/Maxi-03-...	Valve terminals with MIDI/MAXI pneumatics	Instructions on assembly, installation, commissioning and diagnostics of the MIDI/MAXI pneumatic components.
P.BE-MPA-...	Valve terminals with MPA pneumatics	Instructions on assembly, installation, commissioning and diagnostics of the MPA pneumatic components.

User documentation – GSD, EDS, ...

Device description files and icons are used to explain the integration of the CPX terminal in the configuration software of the various controller manufacturers.

These can be downloaded quickly and conveniently from www.festo.com.



Terminal CPX

Accessories

CPX macro library for ePLAN	
Type	GSWC-TE-EP-LA
Part No.	537 041

Project planning – pure service:
ePLAN macros for fast and reliable planning of electrical projects in combination with valve terminals. Available in German and English.



Key technical data

- CD with CPX macro library ePLAN 5 and P8 for CPX terminal (supports the planning of bus nodes, inter-linking blocks, I/O modules, connection blocks, pneumatic interface and valves)
- Creation and administration of projects

Systematically more reliable:
The CPX macro library contains symbols, graphics and master data. Result: a fast, reliable and standardised system for designing and documenting your circuits.

- Creation and editing of circuit diagrams, terminal and cable plans, cross-reference lists, assembly drawings, parts lists and maintenance plans
- Connection to programmable logic controllers
- Generation of the contact and potential cross-references

Simply practical:
High level of planning reliability, standardisation of documentation, no need to create symbols, graphics and master data since everything is stored in the CPX macro library.

- Automatic protective contact mirroring
- Generation of documents in paper format and HTML format for viewing in browsers, etc. Library in DXF format for use with AutoCad or other CAD programs

Design example:
From an idea to a functional solution – quickly and reliably
Project planning, design, production, assembly, commissioning, service

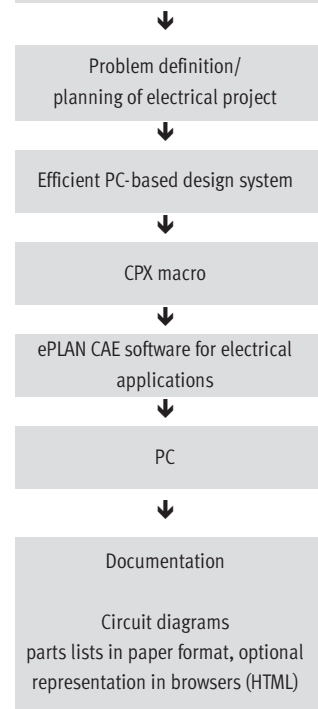

fluidPLAN from ePLAN and FluidDRAW from Festo

ePLAN and Festo also work together in the creation of pneumatic circuit diagrams:
The Engineering Tool ePLAN fluid has a direct interface to the Festo electronic

catalogue (DKI). All of the relevant data for the parts lists as well as the pneumatic circuit symbols for Festo products are transferred using this import function.

The FluidDRAW software from Festo makes the creation of circuit diagrams

for the pneumatic part on the PC both simple and intuitive.

Terminal CPX

Technical data – Operator unit

FESTO

-  - Width
81 mm

The operator unit is a small, convenient commissioning and service device for the CPX terminal. It provides data requisition, configuration and diagnostics functions for CPX terminals. Its extremely flexible application range means that data can be read in or out at any location. IP65 compatibility makes it suitable for use in harsh industrial environments.



Application

Functions

- Advance commissioning through the monitoring/forcing of inputs and outputs without fieldbus master/PLC
- Test function for parameter settings, e.g. fail-safe of the outputs or switch-on delay of the inputs
- Plain text diagnostics of module and channel-oriented errors
- Condition monitoring: preselection/loading of counters, activation of the channels to be monitored
- Display of the last 40 error occurrences with timestamp
- Identification of sporadic causes of errors through display of the diagnostic history
- Password protection

Connection

The operator unit is connected to the CPX bus nodes or control block, as appropriate, using a pre-assembled M12 cable.

The voltage for the operator unit is supplied through the CPX bus node.
→ Plug & Work.

Communication

Once connected to the CPX terminal, the operator unit loads the available configuration for the I/O modules, valves, etc.

This ensures the availability of up-to-date texts, messages, menus and displays.

Status information, diagnostic messages and parameter bits are exchanged during operation.

Mounting

A mounting bracket for the operator unit offers the option of wall or H-rail mounting.

The mounting bracket also has an option for temporary mounting using a hanging device.

Terminal CPX

Technical data – Operator unit

Connection

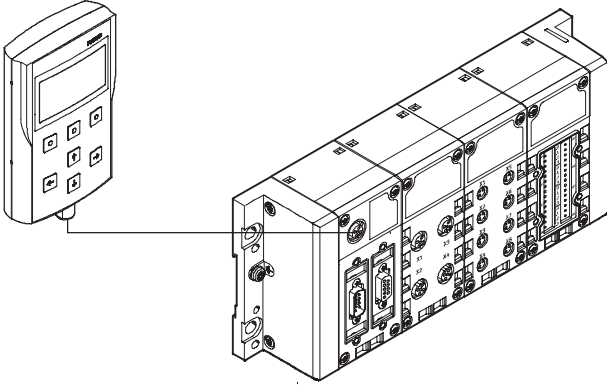

The operator unit is connected to the CPX terminal using pre-assembled cables.

Function examples

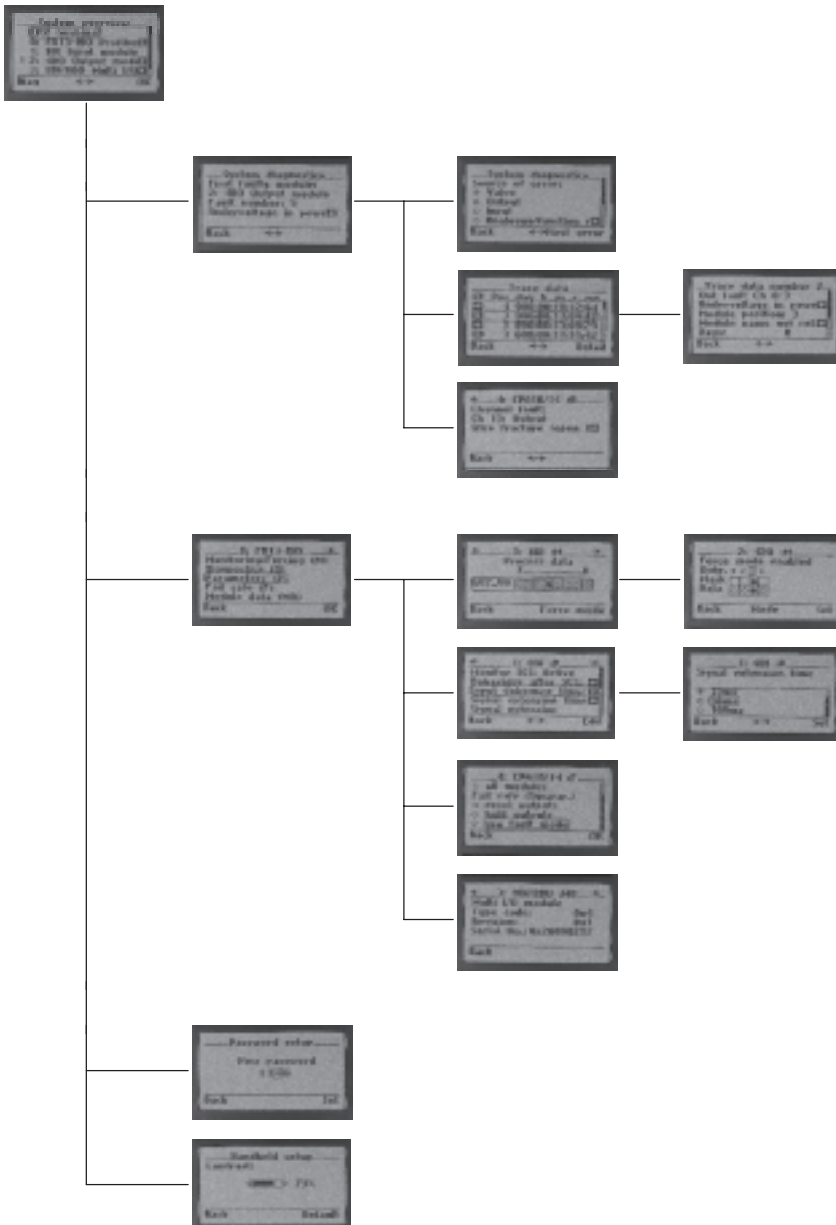

System overview

- Overview of configured modules and current diagnostic messages

Diagnostics

- Fast access to the diagnostic history and the modules with diagnostic messaging
- Display of the last 40 diagnostic messages with timestamp
- Display of the current diagnostic message for a module

Commissioning

- Selection of module-specific data and parameters
- Display and modification of the current status of the inputs and outputs of a module
- Display and modification of the current settings for module-specific parameters

Setup

- Setting of access permission (password)
- Contrast setting of the display

Terminal CPX

Technical data – Operator unit

FESTO

General technical data		
Type	CPX-MMI-1	
Part No.	529043	
Interface data	RS 232 interface, 57.6 Kbaud, M12 socket, 4-pin	
Display elements	LCD graphical display with background illumination (128 x 64 pixels)	
Control elements	7 keys: 4 arrow keys and 3 function keys, touch-sensitive keypad	
Interface	M12-5-pin	
Electromagnetic compatibility	Interference emission tested to DIN EN 61000-6-4, industry	
	Interference immunity tested to DIN EN 61000-6-2, industry	
Normal operating voltage	[V DC]	24, supplied from the connected device
Operating voltage range	[V DC]	18 ... 30
Current consumption	[mA]	50 ... 60
Protection class to IEC 60529	IP65, IP67	
Relative air humidity	[%]	90, non-condensing
Vibration resistance	Tested to DIN/IEC 68/EN 60068, Part 2-6	
	<ul style="list-style-type: none"> • For wall mounting: severity level 2 • For H-rail mounting: severity level 1 	
Shock resistance	Tested to DIN/IEC 68/EN 60068, Part 2-27	
	<ul style="list-style-type: none"> • For wall mounting: severity level 2 • For H-rail mounting: severity level 1 	
Temperature range	Operation	[°C] 0 ... +50
	Storage/transport	[°C] -20 ... +70
Materials	Reinforced polyamide	
Dimensions (W x H x D)	[mm]	81 x 137 x 28
Weight	[g]	150

Operating and environmental conditions		
Ambient temperature	[°C]	0 ... 50
CE mark (see declaration of conformity)	In accordance with EU explosion protection directive (ATEX)	
ATEX category	II 3 G	
	II 3 D	
ATEX symbol	II 3D Ex tD A22 IP65 T60 °C X	
	II 3G Ex nA II T6 X	
ATEX ambient temperature	[°C]	0 ≤ Ta ≤ +50

- Note

If device combinations are operated in potentially explosive areas, the lowest common zone, the temperature class as well as the ambient temperature of the individual devices determine the possible use of the complete module.

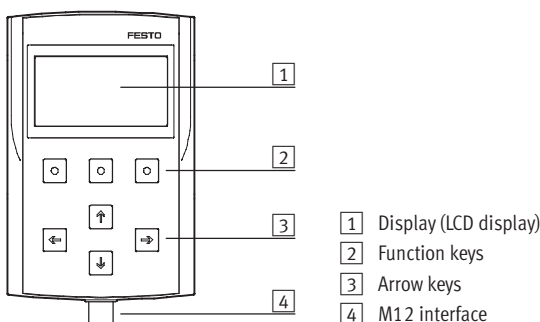

Connection and display components



Terminal CPX

Accessories – Operator unit

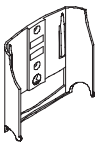
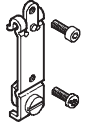
FESTO

Ordering data				
Designation			Type	Part No.
Connecting cable				
	Connecting cable M12-M12, specially designed for CPX-MMI	1.5 m	KV-M12-M12-1,5	529044
		3.5 m	KV-M12-M12-3,5	530901
Mounting				
	Bracket		CPX-MMI-1-H	534705
	Mounting for H-rail		CPX-MMI-1-NRH	536689
User documentation				
	User manual for operator unit CPX-MMI-1	German	P.BE-CPX-MMI-1-DE	534824
		English	P.BE-CPX-MMI-1-EN	534825
		French	P.BE-CPX-MMI-1-FR	534827
		Italian	P.BE-CPX-MMI-1-IT	534828
		Swedish	P.BE-CPX-MMI-1-SV	534829
		Spanish	P.BE-CPX-MMI-1-ES	534826

Terminal CPX

Technical data – CPX maintenance tool

Function

The CPX maintenance tool (CPX-FMT) combines service software with a connecting adapter. The service software is a tool for the design, parameterisation and online diagnostics of the CPX terminal. The USB-to-M12 adapter features built-in electrical isolation (between CPX and PC) and enables a PC to be connected to the diagnostic interface of the CPX terminal.

- Adapter
- Software on CD-ROM

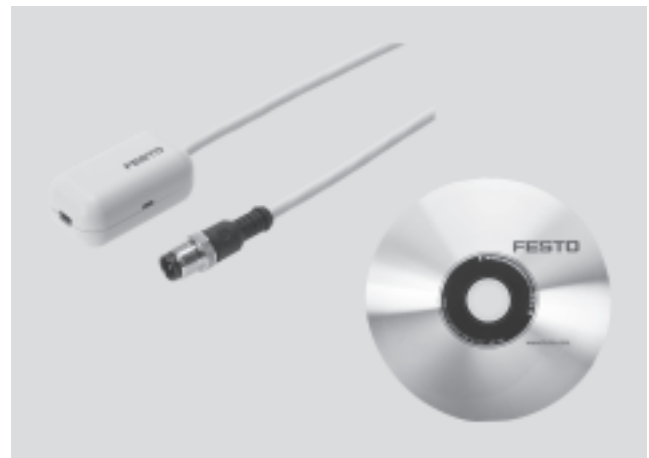

Application

Only from Festo

The CPX-FMT software enables access to CPX valve terminals via Ethernet with the control block CPX-FEC and the fieldbus nodes Ethernet IP (FB 32) and ProfiNET (FB 33, FB 34). The fieldbus nodes or control block can be connected directly to the PC via a USB adapter from Festo. Similar to the CPX-MMI, diagnostic data such as the

error trace or module diagnostics can be read out and parameters can be modified in plain text. In contrast to the CPX-MMI, the data can be used directly on a PC. There is an option, for example, to send screenshots of a configuration or the current error trace directly via e-mail. In addition, CPX configurations can also be saved

and archived directly as a CPX-FMT project. Undocumented changes can subsequently be identified using the online/offline comparison function. On-site tests such as the actuation of valves or the emulation of sensor feedback (in both cases called “forcing”), for example, can be

performed without an existing controller infrastructure. It must be noted that with both the CPX-FMT and the CPX-MMI, only local parameters on the CPX valve terminal can be changed and saved. The configuration of the networks or controller software cannot be influenced.

General technical data		
Type	NEFC-M12G5-0.3-U1G5	
Part No.	547432	
System requirements	PC	IBM-compatible
	Drive	CD-ROM
	Interfaces	USB port (specification USB 1.1 or higher)
	Operating system	Microsoft Windows 2000 or XP
Functional range	<ul style="list-style-type: none"> • Configuration and parameterisation • Reading out of system, module, channel diagnostics and error trace • Saving of the configuration as a project • Integration of plug-ins/links to self-executing programs 	
Scope of delivery	<ul style="list-style-type: none"> • Adapter cable from 5-pin M12 to mini USB socket • CD-ROM with installation program 	
Type of mounting	Screw-in	
Electrical connection	Plug M12x1, 5-pin	
Adapter cable composition	4 x 0.34 mm ²	
Cable length	[m]	0.3
Protection class to EN 60529	IP20	
CE mark (see declaration of conformity)	To EU EMC Directive	
Ambient temperature	[°C]	-5 ... +50
Material	Housing	Acrylic butadiene styrene
	Cable sheath	Polyurethane
	Crimp connector	Gold-plated brass
Note on materials	RoHS-compliant	

Terminal CPX

Technical data – CPX maintenance tool

Display components

Creating a device configuration using the editor

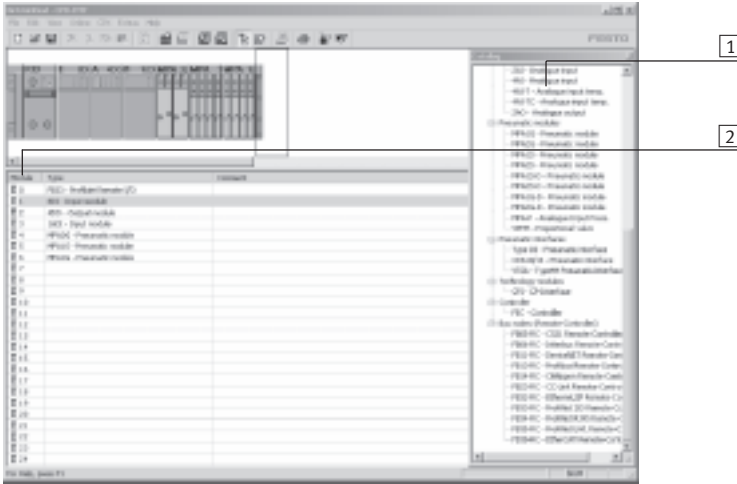

The device configuration can be conveniently generated, parameterised and saved using the drag & drop feature. You can insert and move modules.

- 1 Module numbers from the graphic system overview
- 2 Catalogue for selecting required modules

Module overview for a selected module

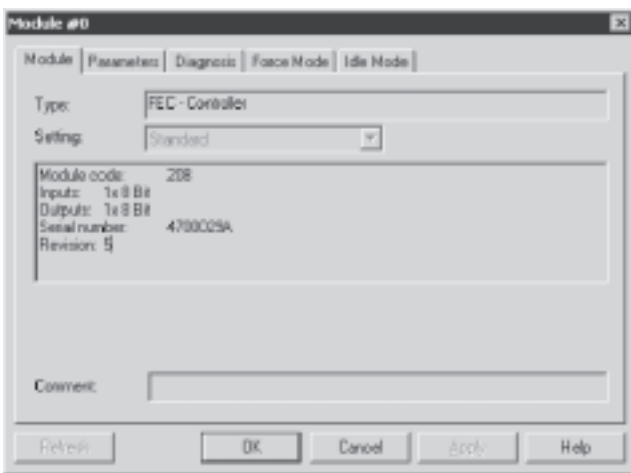

Displays important module data as well as the number of allocated inputs and outputs.

Diagnostic memory

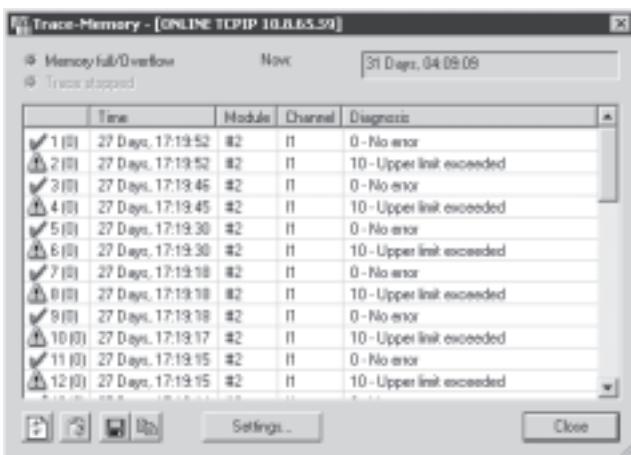

Faults which occur during operation are entered in a diagnostic memory. The first or the last 40 entries are saved, as well as the relevant time measured from the moment the power supply was switched on.

Terminal CPX

Technical data – CPX maintenance tool

Dimensions

Download CAD data → www.festo.com

Adapter

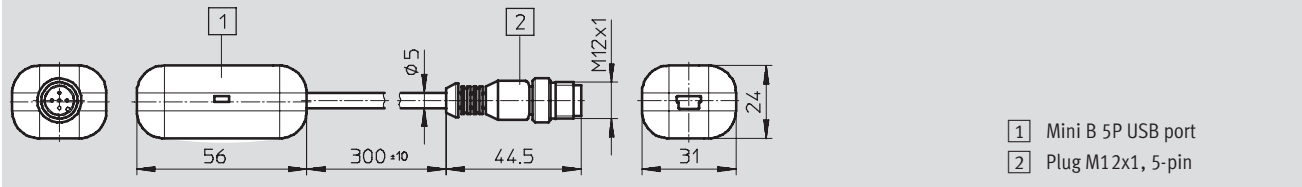

Terminal CPX

Technical data – Web Monitor

Function

Web Monitor is a software tool from Festo for all CPX modules with integrated web server and Ethernet connection for displaying the CPX service information in real time on a PC connected via a network. This tool provides virtually "free" access to diagnostic and service information, which offers the following benefits:

- Online, up-to-date
- No separate programming
- No separate visualisation

This saves a lot of time and means that there is no need to acquire in-house expertise.

- Supplied on CD-ROM
- Installation on PC
- Adaptation to application
- Loading via Ethernet to the web server of the CPX module
- Display possibility via local touch displays (FED 710, 1010, 2010 or 5010)



Application

Only from Festo

CPX is a modular electrical terminal for the connection of pneumatic and electrical control loop systems to automation systems – suitable for all currently used fieldbus systems.

Valve terminals with the comprehensive diagnostic package consisting of pneumatics, electrics and networking systems create unique synergies and

simplify the communication between the electrical and pneumatic control levels. The Web Monitor makes this diagnostic and additional information

visible at every station and without extra programming. Convenient error analysis by Web Monitor provides permanent diagnostic reliability.

General technical data		
Type	CPX-WEB-MONITOR	
Part No.	545413	
System requirements	PC	IBM-compatible, Pentium class or comparable
	Drive	CD-ROM
	Interfaces	Network connection and access
	Operating system	Microsoft Windows 98, ME, 2000 or XP
Browser requirements	Microsoft Internet Explorer	Version 5.5 and later
	Mozilla Firefox	Version 1.0 and later (full version of Web Monitor only)
	Java plug-in	Java Runtime Environment (JRE) 1.3 or higher
Java script	Enabled	
Cookies	Enabled	
Scope of functions	<ul style="list-style-type: none"> • Changing HTML links • Changing symbol names for systems, modules and channels • Incorporating own web pages • Changing passwords • Incorporating Java applets • Commands for dynamic contents 	
Scope of delivery	CD-ROM with	<ul style="list-style-type: none"> • Installation program • Description in German and English • E-mail driver for FST projects (only relevant when using CPX-FEC modules): SMTP-Driver V0.5 • HTML pages for the web server of CPX terminals
Configurable e-mail alerts	8	
Non-volatile storage of e-mail alerts	Yes	
Sending of e-mails	Initiated by events (positive edge at input bit, output bit, diagnostic bit, flag bit)	
E-mail text	Max. 255 characters	

Display elements

System overview of CPX terminal

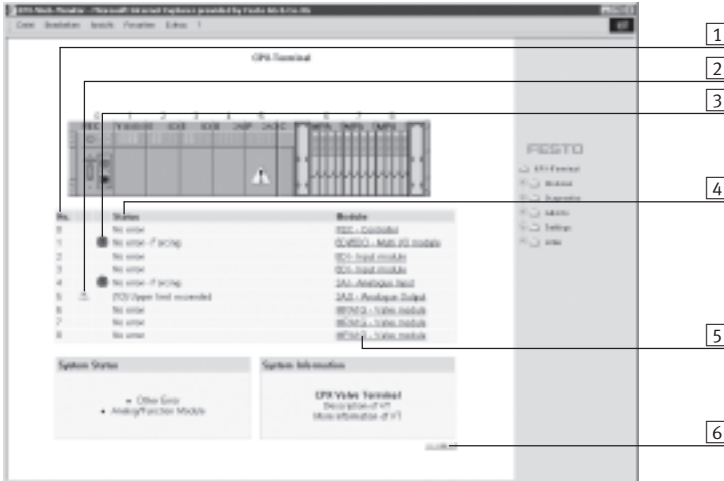

- 1 Module numbers from the graphic system overview
- 2 Signalling of fault messages via yellow warning triangle analogous to graphic system overview opposite
- 3 Signalling of activated Force mode via exclamation mark on blue background
- 4 Status information in plain text
- 5 Module designations
- 6 Monitoring display for data communication

Module overview of a selected module

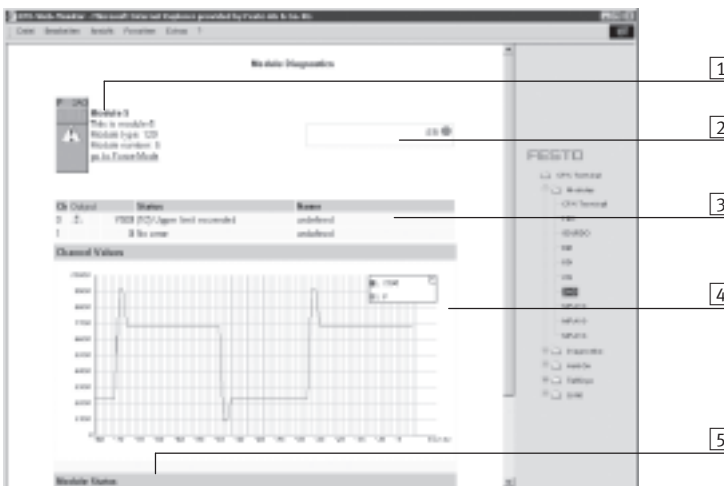

- 1 General information about the module
- 2 Copy of the module display elements
- 3 Table with status information on all channels of the module
- 4 Graphic representation of the channel values plotted on a time axis
- 5 Graphic representation of the module status plotted on a time axis

Error log of the CPX Web Monitor

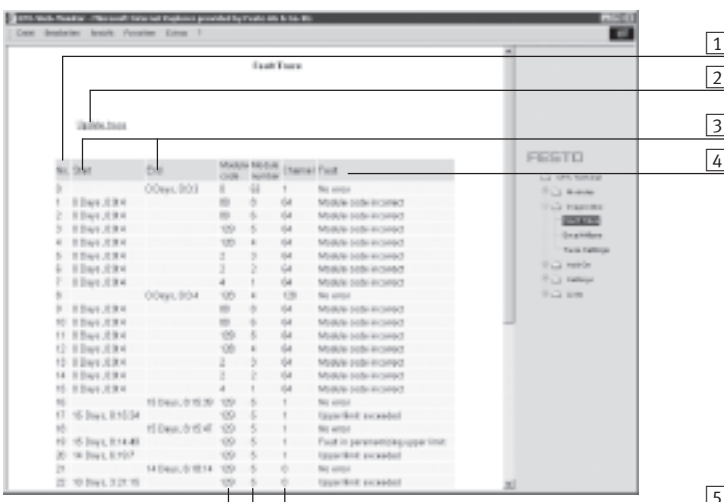

- 1 Sequence number of the entries
- 2 Link for updating the log ("Update trace")
- 3 Start/end time of the message
- 4 Text message
- 5 Module affected (module code/M. number/channel)

Terminal CPX

Technical data – Control block CPX-FEC

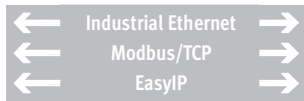

IT services:



Powerful control block for pre-processing actuation of the CPX modules. The voltage supply to and communication with other modules takes place via the interlinking block. In addition to the connection for the Ethernet interface in RJ45 and a programming interface in Sub-D, LEDs are also provided for the bus status, operating status of the PLC and CPX peripherals information, as are switching elements and a diagnostic interface for CPX-MMI and CPX-FMT.



Application

Bus connection	Modbus/TCP (code T05)
The CPX-FEC is a separate controller, which can be connected to a higher-order PLC via the fieldbus nodes of the CPX terminal or via Ethernet. At the same time, it is possible to operate the CPX-FEC as a compact standalone controller directly on the machine.	Transmits data in binary format within TCP/IP packets. This ensures good data throughput.

Operating modes	Communication protocols
<ul style="list-style-type: none"> • Standalone/EasyIP • Fieldbus remote controller • Modbus/TCP remote controller • Remote I/O Modbus/TCP 	<ul style="list-style-type: none"> • Profibus, Profinet, DeviceNet, Interbus, CANopen, EtherCAT and CC-Link via CPX fieldbus nodes • Modbus/TCP • EasyIP • IP • TCP • UDP • SMTP • HTTP • DHCP • BootP • TFTP

Setting options

For monitoring, programming and commissioning, CPX-FEC has the following interfaces:	<ul style="list-style-type: none"> • For the CPX-MMI/-FMT • Serial interface RS232, for example, for a Front End Display (FED) • Ethernet interface for IT applications • Remote diagnostics via an FED and CPX Web Monitor 	The operating mode and fieldbus protocol are set using the DIL switch on the CPX-FEC.	The integrated web server offers a convenient means of querying data saved in the CPX-FEC.
--	---	---	--

Terminal CPX

Technical data – Control block CPX-FEC

FESTO

General technical data			
Type		CPX-FEC-1-IE	
Part No.		529041	
Ethernet interface		RJ45 (8-pin, socket)	
Data interface		RS232 (Sub-D, 9-pin, socket)	
MMI interface		M12, 5-pin, socket	
Baud rates	Ethernet interface	[Mbps]	10/100 (acc. to IEEE802.3, 10BaseT)
	Data interface	[kbps]	9.6 ... 115.2
	MMI interface	[kbps]	56.6
Protocol		<ul style="list-style-type: none"> • TCP/IP • EasyIP • Modbus TCP • HTTP 	
Processing time for 1,024 binary instructions		[ms]	Approx. 1
Flags		M0.0 ... M9999, addressable as bits or words	
		No. of time flags	T0 ... T255
		Time range	[s] 0.01 to 655.35
		No. of counting flags	Z0 ... Z255
		Counting range	0 to 65535
Register		R0 ... R255, addressable as words	
Special FE		FE 0 ... 255, init flag	
IP address setting		BOOTP/DHCP via FST or via MMI/FMT	
Max. address capacity	Inputs	[Byte]	64
	Outputs	[Byte]	64
Program memory	User program	[kB]	250
	WEB applications	[kB]	550
Programming language		<ul style="list-style-type: none"> • STL • LDR 	
Arithmetic functions		+, -, *, :, further functions via functional modules	
Functional modules		<ul style="list-style-type: none"> • CPX diagnostic status • Copy CPX diagnostic trace • Read CPX module diagnostics • Write CPX module parameter • ... 	
No. of programs/tasks		P0 ... P63	
LED displays (FEC-specific)		RUN = Program is being executed/Modbus connection active STOP = Program is stopped/no Modbus connection ERR = Error in the program execution TP = Status of the Ethernet connection	
Device-specific diagnostics		Module and channel-specific diagnostics via peripherals error	
Parameterisation		<ul style="list-style-type: none"> • Start-up parameterisation via FST • Parameterisation of the operating time via the functional module 	
Control elements		<ul style="list-style-type: none"> • DIL switch for setting the operating mode • Rotary switch for program selection/program start 	
Additional functions		<ul style="list-style-type: none"> • Storage of the last 40 errors with timestamp (access via PCP) • 8 bit system status in image table for inputs • 2 byte inputs and 2 byte outputs, system diagnostics in image table 	

Terminal CPX

Technical data – Control block CPX-FEC

FESTO

General technical data			
Type	CPX-FEC-1-IE		
Part No.	529041		
Operating voltage	Nominal value	[V DC]	24 (reverse polarity protected)
	Permissible range	[V DC]	18 ... 30
	Power failure bridging	[ms]	10
Residual ripple		[Vss]	4
Current consumption		[mA]	Max. 200
Interference emission	To EN 61000-6-4 (industry)		
Interference immunity	To EN 61000-6-2 (industry)		
Protection class to EN 60529	IP65/IP67		
Temperature range	Operation	[°C]	-5 ... +50
	Storage/transport	[°C]	-20 ... +70
Materials	Polymer		
Grid dimension		[mm]	50
Dimensions (including interlinking block) W x L x H		[mm]	50 x 107 x 55
Weight	Without interlinking block	[g]	140
	Including interlinking block without power supply	[g]	220
	Including interlinking block with system supply	[g]	240

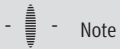

Note

Please observe the general limits and guidelines for the system when configuring the electrical modules.

	Standalone	Remote controller		Remote I/O
		Ethernet	Fieldbus	Modbus/TCP
CPX-FEC function	Controller	Controller and communication		Ethernet slave
CPX module controlled by	CPX-FEC	CPX-FEC		Higher-order controller
Pre-processing of data in the FEC	Yes	Yes		No
Communication with higher-order controller	No	Via Ethernet • EasyIP • Modbus/TCP	Via fieldbus	Via Ethernet • EasyIP • Modbus/TCP
Web server	Possible	Possible		Possible
Configuration	FST 4.1 or higher	FST 4.1 or higher		Higher-order controller
Parameterisation	Via FST/CPX-MMI/-FMT	Via FST/CPX-MMI/-FMT		Via CPX-MMI//FMT, Modbus
Order code	T03	T03		T05
Addressing	Changeable	Changeable		Prescribed
Memory	• 250 kB for user program • 550 kB for WEB applications	• 250 kB for user program • 550 kB for WEB applications		• 800 kB for WEB applications
CPX-MMI/-FMT	Can be connected to CPX-FEC	Can be connected to CPX-FEC		Can be connected to CPX-FEC

Terminal CPX

Technical data – Control block CPX-FEC

Connection and display components



Pin allocation for the programming interface (RS232)

Pin allocation	Pin	Signal	Description
Sub-D plug			
	1	n.c.	Not connected
	2	RxD	Received data
	3	TxD-P	Transmitted data
	4	n.c.	Not connected
	5	GND	Data reference potential
	6	n.c.	Not connected
	7	n.c.	Not connected
	8	n.c.	Not connected
	9	n.c.	Not connected
	Housing	Screened	Connection to (FE) functional earth







Pin allocation for the Ethernet interface

Pin allocation	Pin	Signal	Description
Plug RJ45			
	1	TD+	Transmitted data+
	2	TD-	Transmitted data-
	3	RD+	Received data+
	4	n.c.	Not connected
	5	n.c.	Not connected
	6	RD-	Received data-
	7	n.c.	Not connected
	8	n.c.	Not connected
Housing	Screened	Screening	

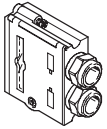
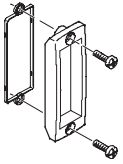
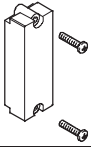
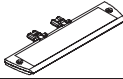
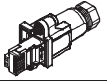
Terminal CPX

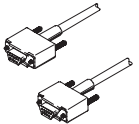
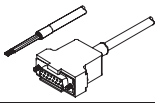
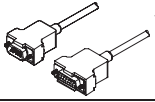
Accessories – Control block CPX-FEC

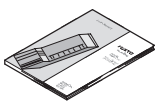
FESTO

Ordering data				
Designation		Type	Part No.	
Bus connection				
	Sub-D plug	FBS-SUB-9-GS-1x9POL-B	534497	
	Inspection cover, transparent	AK-SUB-9/15-B	533334	
	Inspection cover, for use in Atex environments as per certification (→ 44)	AK-SUB-9/15	557010	
	Inscription label holder for connection block	CPX-ST-1	536593	
	RJ45/plug	FBS-RJ45-8-GS	534494	
	Cover for RJ45 connection	AK-Rj45	534496	
	Programming cable	KDI-PPA-3-BU9	151915	
	Connecting cable FED	FEC-KBG7	539642	
	Connecting cable FED	FEC-KBG8	539643	
	Adapter cable M12, 5-pin at socket Mini-USB and controller software	NEFC-M12G5-0.3-U1G5	547432	
User documentation				
	User documentation for control block CPX-FEC	German	P.BE-CPX-FEC-DE	538474
		English	P.BE-CPX-FEC-EN	538475
		Spanish	P.BE-CPX-FEC-ES	538476
		French	P.BE-CPX-FEC-FR	538477
		Italian	P.BE-CPX-FEC-IT	538478
		Swedish	P.BE-CPX-FEC-SV	538479
Software				
	CPX remote diagnostics and process visualisation	CPX-WEB-MONITOR	545413	
	Programming software	German	FST4.1DE	537927
		English	FST4.1GB	537928

Terminal CPX

Technical data – Bus node CPX-FB6



Bus node for handling communication between the electrical CPX terminal and a higher-order master via INTERBUS.

The bus node receives system supply from the interlinking block and processes communication via the I/O modules.

The status of the CPX terminal is displayed as a common message via 4 CPX-specific LEDs.

The fieldbus communication status is displayed via 4 INTERBUS-specific LEDs.



Application

Bus connection

The bus connection is established via a 9-pin Sub-D socket and a 9-pin Sub-D plug with a typical INTERBUS pin allocation.

The bus connector plugs (with protection class IP65/IP67 from Festo or IP20 from other manufacturers) facilitate the connection of the incoming and outgoing bus cable.

The outgoing bus plug contains the typical INTERBUS RBST bridge for identification of the outgoing bus connection.

The Sub-D interfaces are designed for the control of network components with a fibre optic cable connection.

INTERBUS implementation

The CPX-FB6 supports the INTERBUS protocol to EN 50254.

In addition to synchronous I/O exchange, the optional PCP channel can be used for parameterisation and diagnostic functions.

The PCP channel provides access to advanced system information and assigns operation parameters while the controller is running via the user program.

An example of this is access to the integrated diagnostic memory function, i.e. storage of the last 40 errors with timestamp, module, channel and error type.

With its address capacity of 96 inputs and 96 outputs, the CPX-FB6 supports a large number of I/O module configurations, including pneumatic interface.

 Note
If the PCP channel is used, the maximum number of possible process data bits is reduced by 16.

Special features in combination with CPX-FEC

When a fieldbus node is combined with a CPX-FEC (in the fieldbus remote controller operating mode), the connected I/Os and/or valves, sensors and actuators are actuated via the CPX-FEC.

In this case, the fieldbus node only provides the communication interface to the PLC.

Communication between CPX-FEC and CPX fieldbus node takes place via interlinking of the CPX modules.

The CPX-FEC occupies an address capacity of the CPX fieldbus node of:

- 8 byte outputs
- 8 byte inputs

As no other components (e.g. I/O modules) are actuated via the CPX fieldbus node, its address capacity is thus reduced effectively to an 8 byte I/O.

The full address capacity of the CPX-FEC is available for actuation of the peripherals:

- 64 byte inputs
- 64 byte outputs

Terminal CPX

Technical data – Bus node CPX-FB6

FESTO

General technical data			
Type	CPX-FB6		
Part No.	195748		
Fieldbus interface	Sub-D, 9-pin, socket and pin		
Baud rates	[Mbps]	0.5 and 2	
Bus type	Remote bus		
Ident. code	1, 2 or 3 (configuration-specific) 243 (PCP channel activated)		
Profile	12 (I/O device)		
PCP channel	Yes, 16 bit (optional via DIL switch)		
Configuration support	Icons for CMD software		
Max. no. of process data bits	Inputs	[Bit]	96
	Outputs	[Bit]	96
LED displays (bus-specific)	UL = Operating voltage for INTERBUS interface RC = Remotebus check BA = Bus active RD = Remotebus disable TR = Transmit/receive		
Device-specific diagnostics	Via peripherals errors		
Parameterisation	<ul style="list-style-type: none"> Start-up parameterisation via user functions (CMD) Via PCP communication 		
Additional functions	<ul style="list-style-type: none"> Storage of the last 40 errors with timestamp (access via PCP) 8 bit system status in image table for inputs 2 byte inputs and 2 byte outputs, system diagnostics in image table 		
Operating voltage	Nominal value	[V DC]	24 (reverse polarity protected)
	Permissible range	[V DC]	18 ... 30
	Power failure bridging	[ms]	10
Current consumption			[mA] Max. 200
Protection class to EN 60529	IP65/IP67		
Temperature range	Operation	[°C]	-5 ... +50
	Storage/transport	[°C]	-20 ... +70
Materials	Polymer		
Grid dimension			[mm] 50
Dimensions (including interlinking block) W x L x H			[mm] 50 x 107 x 50
Weight	Without interlinking block	[g]	125
	Including interlinking block without power supply	[g]	205
	Including interlinking block with system supply	[g]	225

 Note

Please observe the general limits and guidelines for the system when configuring the electrical modules.

Terminal CPX

Technical data – Bus node CPX-FB6

Connection and display components

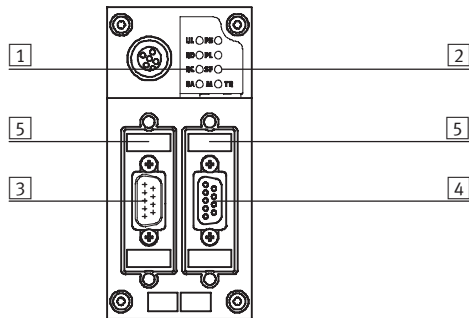

- 1 INTERBUS-specific LEDs
- 2 CPX-specific status LEDs
- 3 Fieldbus connection, incoming (9-pin Sub-D, pin)
- 4 Fieldbus connection, outgoing (9-pin Sub-D, socket)
- 5 DIL switch

Pin allocation for the INTERBUS interface

Pin allocation for Sub-D	Pin	Signal	Description	Pin	Pin allocation for M12
Incoming					
	1	DO1	Data out	1	
	2	DI1	Data in	3	
	3	GND	Reference conductor/earth	5	
	4	n.c.	Not connected	2	
	5	n.c.	Not connected	4	
	6	/DO1	Data out inverse		
	7	/DI1	Data in inverse		
	8	n.c.	Not connected		
	9	n.c.	Not connected		
	Hous- ing	Screened	Connection to FE (functional earth) via R/C combination	Hous- ing	
Outgoing					
	1	DO2	Data out	1	
	2	DI2	Data in	3	
	3	GND	Reference conductor/earth	5	
	4	n.c.	Not connected	2	
	5	+5 V	Station detection ¹⁾	4	
	6	/DO2	Data out inverse		
	7	/DI2	Data in inverse		
	8	n.c.	Not connected		
	9	RBST	Station detection ¹⁾		
	Hous- ing	Screened	Connection to FE (functional earth)	Hous- ing	



The incoming interface is galvanically isolated from the CPX peripherals. The plug housing is connected to the functional earth FE of the CPX terminal via an R/C combination.

1) The CPX terminal contains the protocol chip SUPI 3 OPC. This ensures automatic detection of additional connected INTERBUS stations. There is therefore no need for a bridge between pin 5 and pin 9.

Terminal CPX

Accessories – Bus node CPX-FB6

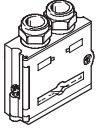
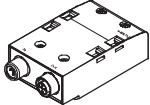
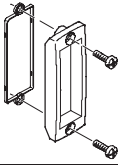
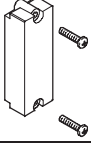
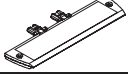
FESTO

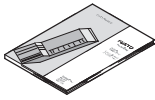
Ordering data				
Designation			Type	Part No.
Bus connection				
	Sub-D plug	Incoming	FBS-SUB-9-BU-IB-B	532218
		Outgoing	FBS-SUB-9-GS-IB-B	532217
	Connection block M12 adapter plug (B-coded)		CPX-AB-2-M12-RK-IB	534505
	Inspection cover, transparent		AK-SUB-9/15-B	533334
	Inspection cover, for use in Atex environments as per certification (→ 44)		AK-SUB-9/15	557010
	Inscription label holder for connection block		CPX-ST-1	536593
	Threaded sleeve, 4 pieces		UNC4-40/M3x6	533000
	Adapter cable M12, 5-pin at socket Mini-USB and controller software		NEFC-M12G5-0.3-U1G5	547432
User documentation				
	User documentation for bus node CPX-FB6	German	P.BE-CPX-FB6-DE	526433
		English	P.BE-CPX-FB6-EN	526434
		Spanish	P.BE-CPX-FB6-ES	526435
		French	P.BE-CPX-FB6-FR	526436
		Italian	P.BE-CPX-FB6-IT	526437
		Swedish	P.BE-CPX-FB6-SV	526438

Terminal CPX

Technical data – Bus node CPX-FB11



Bus node for handling communication between the electrical CPX terminal and a DeviceNet network.

The bus node receives system supply from the interlinking block and processes communication via the I/O modules.

The status of the CPX terminal is displayed as a common message via 4 CPX-specific LEDs.

The fieldbus communication status is displayed via the 3 DeviceNet-specific LEDs.



Application

Bus connection

The bus connection can be selected when ordering, either Micro Style as 2xM12 round connectors or OpenStyle as a terminal strip with IP20 protection.

Both connection types have the function of an integrated T-distributor with incoming and outgoing bus line.

DeviceNet implementation

The CPX-FB11 operates with the “Predefined Master/Slave connection set” as a “Group 2 only Server”. The polled I/O, change of state or synchronous method is used for the transmission of synchronous I/O data. The type of transmission can be selected in the network configuration.

The device diagnostics for all bus nodes CPX-FB11 is effectively gathered via strobed I/O and displayed in the input table of the controller. In addition to synchronous data transmission, asynchronous communication is supported through explicit messaging, which enables detailed device diagnostics and parameterisation.

A comprehensive EDS file supports the display of asynchronous data. It is also possible to display system information and assign parameters while the controller is running via the user program or the configuration software.

An example of this is access to the integrated diagnostic memory function, i.e. storage of the last 40 errors with timestamp, module, channel and error type. With its address capacity of 64 byte inputs and 64 byte outputs, the CPX-FB11 supports any configuration of I/O modules, including pneumatic interface.

Special features in combination with CPX-FEC

When a fieldbus node is combined with a CPX-FEC (in the fieldbus remote controller operating mode), the connected I/Os and/or valves, sensors and actuators are actuated via the CPX-FEC.

In this case, the fieldbus node only provides the communication interface to the PLC. Communication between CPX-FEC and CPX fieldbus node takes place via interlinking of the CPX modules.

The CPX-FEC occupies an address capacity of the CPX fieldbus node of:

- 8 byte outputs
- 8 byte inputs

As no other components (e.g. I/O modules) are actuated via the CPX fieldbus node, its address capacity is thus reduced effectively to an 8 byte I/O.

The full address capacity of the CPX-FEC is available for control of the peripherals:

- 64 byte inputs
- 64 byte outputs

Terminal CPX

Technical data – Bus node CPX-FB11

FESTO

General technical data			
Type	CPX-FB11		
Part No.	526172		
Fieldbus interface	Either <ul style="list-style-type: none"> • MicroStyle bus connection: 2xM12 protection class IP65/IP67 • OpenStyle bus connection: 5-pin terminal strip IP20 		
Baud rates	[kbps]	125, 250, 500	
Addressing range	0 ... 63 Set using DIL switch		
Product	Type	Communication adapter (12 dec.)	
	Code	4554 dec.	
Communication types	Polled I/O, change of state/synchronous, strobed I/O and explicit messaging		
Configuration support	EDS file and bitmaps		
Max. address capacity	Inputs	[Byte]	64
	Outputs	[Byte]	64
LED displays (bus-specific)	MS = Module status NS = Network status IO = I/O status		
Device-specific diagnostics	Module and channel-oriented diagnostics through manufacturer-specific diagnostics object		
Parameterisation	<ul style="list-style-type: none"> • Module and system parameterisation via configuration interface in plain text (EDS) • Online in run or program mode 		
Additional functions	<ul style="list-style-type: none"> • Storage of the last 40 errors with timestamp (access via EDS) • 8 bit system status in image table for inputs • 2 byte inputs and 2 byte outputs, system diagnostics in image table 		
Operating voltage	Nominal value	[V DC]	24
	Permissible range	[V DC]	18 ... 30
	Power failure bridging	[ms]	10
Current consumption			[mA]
Protection class to EN 60529	IP65/IP67		
Temperature range	Operation	[°C]	-5 ... +50
	Storage/transport	[°C]	-20 ... +70
Materials	Polymer		
Grid dimension			[mm]
Dimensions (including interlinking block) W x L x H			[mm]
Weight	Without interlinking block	[g]	120
	Including interlinking block without power supply	[g]	200
	Including interlinking block with system supply	[g]	220

 - Note

Please observe the general limits and guidelines for the system when configuring the electrical modules.

Terminal CPX

Technical data – Bus node CPX-FB11

Connection and display components

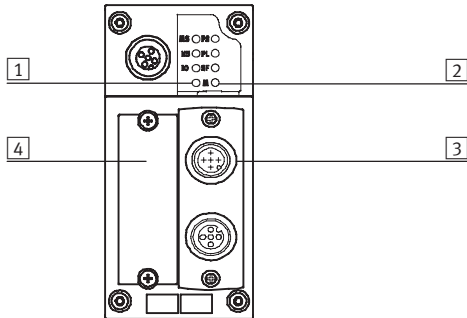

- 1 Bus-specific LEDs
- 2 CPX-specific status LEDs
- 3 Selectable fieldbus connection
Micro Style
Open Style
- 4 DIL switch cover

Pin allocation for the DeviceNet interface







Pin allocation	Pin	Signal-specific core colour ¹⁾	Signal	Description
Sub-D plug				
	1	–	n.c.	Not connected
	2	Blue	CAN_L	Received/transmitted data low
	3	Black	0 V bus	0 V CAN interface
	4	–	n.c.	Not connected
	5	Blank	Screened	Connection to housing
	6	–	n.c.	Not connected
	7	White	CAN_H	Received/transmitted data high
	8	–	n.c.	Not connected
	9	Red	24 V DC bus	24 V DC supply CAN interface
Bus connection Micro Style (M12) incoming/outgoing				
Incoming 	1	Blank	Screened	Connection to housing
	2	Red	24 V DC bus	24 V DC supply CAN interface
	3	Black	0 V bus	0 V CAN interface
	4	White	CAN_H	Received/transmitted data high
	5	Blue	CAN_L	Received/transmitted data low
Outgoing 	1	Blank	Screened	Connection to housing
	2	Red	24 V DC bus	24 V DC supply CAN interface
	3	Black	0 V bus	0 V CAN interface
	4	White	CAN_H	Received/transmitted data high
	5	Blue	CAN_L	Received/transmitted data low
Bus connection Open Style				
	1	Black	0 V bus	0 V CAN interface
	2	Blue	CAN_L	Received/transmitted data low
	3	Blank	Screened	Connection to housing
	4	White	CAN_H	Received/transmitted data high
	5	Red	24 V DC bus	24 V DC supply CAN interface

1) Typical for DeviceNet cables

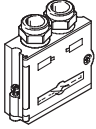
Terminal CPX

Accessories – Bus node CPX-FB11

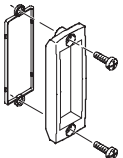
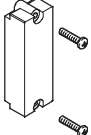
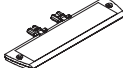
FESTO

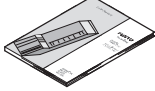
Ordering data				
Designation		Type	Part No.	
Bus connection				
	Sub-D plug	FBS-SUB-9-BU-2x5POL-B	532219	
	Bus connection Micro Style, 2xM12	FBA-2-M12-5POL	525632	
	Socket for Micro Style connection, M12	FBSD-GD-9-5POL	18324	
	Plug for Micro Style connection, M12	FBS-M12-5GS-PG9	175380	
	Fieldbus connection Open Style for 5-pin terminal strip	FBA-1-SL-5POL	525634	
	Terminal strip connector for Open Style connection, 5-pin	FBSD-KL-2x5POL	525635	
	Inspection cover, transparent	AK-SUB-9/15-B	533334	
	Inspection cover, for use in Atex environments as per certification (→ 44)	AK-SUB-9/15	557010	
	Inscription label holder for connection block	CPX-ST-1	536593	
	Adapter cable M12, 5-pin at socket Mini-USB and controller software	NEFC-M12G5-0.3-U1G5	547432	
User documentation				
	User documentation for bus node CPX-FB11	German	P.BE-CPX-FB11-DE	526421
		English	P.BE-CPX-FB11-EN	526422
		Spanish	P.BE-CPX-FB11-ES	526423
		French	P.BE-CPX-FB11-FR	526424
		Italian	P.BE-CPX-FB11-IT	526425
		Swedish	P.BE-CPX-FB11-SV	526426

Terminal CPX

Technical data – Bus node CPX-FB13



Bus node for handling communication between the electrical CPX terminal and a higher-order master via Profibus-DP.

The bus node receives system supply from the interlinking block and processes communication via the I/O modules.

The status of the CPX terminal is displayed as a common message via 4 CPX-specific LEDs.

The fieldbus communication status is displayed via the Profibus-specific fault LED.



Application

Bus connection

The bus connection is established via a 9-pin Sub-D socket with a typical Profibus allocation (to EN 50170).

The bus connector plug (with protection class IP65/IP67 from Festo or IP20 from other manufacturers) facilitates the connection of an incoming and an outgoing bus cable.

An active bus terminal can be connected using the DIL switch integrated in the plug.

The Sub-D interface is designed for the control of network components with a fibre optic cable connection.

Profibus-DP implementation

The CPX-FB13 supports the Profibus-DP protocol to EN 50170 Volume 2 for synchronous I/O exchange, parametrisation and diagnostic functions (DPV0).

In addition to DPV0, asynchronous communication to the advanced specification DPV1 is supported. DPV1 provides asynchronous access to advanced system information and assigns operation parameters while the controller is running via the user program.

An example of this is access to the integrated diagnostic memory function, i.e. storage of the last 40 errors with timestamp, module, channel and error type.

With its address capacity of 64 byte inputs and 64 byte outputs, the CPX-FB13 supports any configuration of I/O modules, including pneumatic interface.

Special features in combination with CPX-FEC

When a fieldbus node is combined with a CPX-FEC (in the fieldbus remote controller operating mode), the connected I/Os and/or valves, sensors and actuators are actuated via the CPX-FEC.

In this case, the fieldbus node only provides the communication interface to the PLC. Communication between CPX-FEC and CPX fieldbus node takes place via interlinking of the CPX modules.

The CPX-FEC occupies an address capacity of the CPX fieldbus node of:

- 8 byte outputs
- 8 byte inputs

As no other components (e.g. I/O modules) are actuated via the CPX fieldbus node, its address capacity is thus reduced effectively to an 8 byte I/O.

The full address capacity of the CPX-FEC is available for actuation of the peripherals:

- 64 byte inputs
- 64 byte outputs

Terminal CPX

Technical data – Bus node CPX-FB13

FESTO

General technical data			
Type	CPX-FB13		
Part No.	195740		
Fieldbus interface	Sub-D socket, 9-pin (EN 50 170) Galvanically isolated 5 V		
Baud rates	[Mbps]	0.0096 ... 12	
Addressing range	1 ... 125 Set using DIL switch		
Product family	4: Valves		
Ident. number	0x059E		
Communication types	DPV0: Synchronous communication DPV1: Asynchronous communication		
Configuration support	GSD file and bitmaps		
Max. address capacity	Inputs	[Byte]	64
	Outputs	[Byte]	64
LED displays (bus-specific)	BF: Bus Fault		
Device-specific diagnostics	Identifier and channel-specific diagnostics to EN 50170 (Profibus standard)		
Parameterisation	<ul style="list-style-type: none"> Start-up parameterisation via configuration interface in plain text (GSD) Asynchronous parameterisation via DPV1 		
Additional functions	<ul style="list-style-type: none"> Storage of the last 40 errors with timestamp (access via DPV1) 8 bit system status in image table for inputs 2 byte inputs and 2 byte outputs, system diagnostics in image table 		
Operating voltage	Nominal value	[V DC]	24
	Permissible range	[V DC]	18 ... 30
	Power failure bridging	[ms]	10
Current consumption	[mA]	Max. 200	
Protection class to EN 60529	IP65/IP67		
Temperature range	Operation	[°C]	-5 ... +50
	Storage/transport	[°C]	-20 ... +70
Materials	Polymer		
Grid dimension	[mm]	50	
Dimensions (including interlinking block) W x L x H	[mm]	50 x 107 x 50	
Weight	Without interlinking block	[g]	115
	Including interlinking block without power supply	[g]	195
	Including interlinking block with system supply	[g]	215

 Note

Please observe the general limits and guidelines for the system when configuring the electrical modules.

Terminal CPX

Technical data – Bus node CPX-FB13

Connection and display components

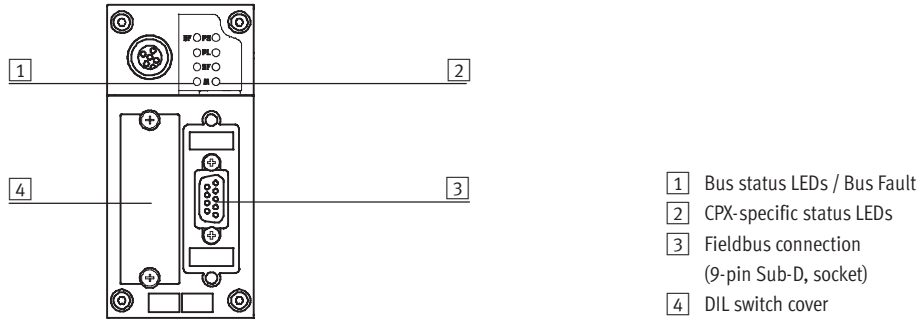

Pin allocation for Profibus-DP interface





Pin allocation	Pin	Signal	Description
Sub-D plug			
	1	n.c.	Not connected
	2	n.c.	Not connected
	3	RxD/TxD-P	Received/transmitted data P
	4	CNTR-P ¹⁾	Repeater control signal
	5	DGND	Data reference potential (M5V)
	6	VP	Supply voltage (P5V)
	7	n.c.	Not connected
	8	RxD/TxD-N	Received/transmitted data N
	9	n.c.	Not connected
	Housing	Screened	Connection to housing
Bus connection M12 adapter plug (B-coded)			
Incoming 	1	n.c.	Not connected
	2	RxD/TxD-N	Received/transmitted data N
	3	n.c.	Not connected
	4	RxD/TxD-P	Received/transmitted data P
	5 and M12	Screened	Connection to FE (functional earth)
Outgoing 	1	VP	Supply voltage (P5V)
	2	RxD/TxD-N	Received/transmitted data N
	3	DGND	Data reference potential (M5V)
	4	RxD/TxD-P	Received/transmitted data P
	5 and M12	Screened	Connection to FE (functional earth)

1) The repeater control signal CNTR-P is realised as a TTL signal.

Terminal CPX

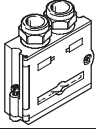
Accessories – Bus node CPX-FB13

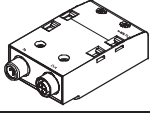
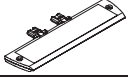
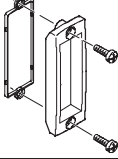
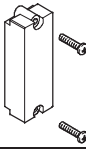
FESTO

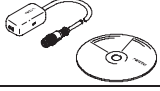
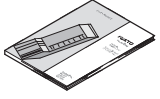
Ordering data				
Designation		Type	Part No.	
Bus connection				
	Sub-D plug	FBS-SUB-9-GS-DP-B	532216	
	Bus connection M12 adapter plug (B-coded)	FBA-2-M12-5POL-RK	533118	
	Connection block M12 adapter plug (B-coded)	CPX-AB-2-M12-RK-DP	541519	
	Inscription label holder for connection block M12	CPX-ST-1	536593	
	Inspection cover, transparent	AK-SUB-9/15-B	533334	
	Inspection cover, for use in Atex environments as per certification (→ 44)	AK-SUB-9/15	557010	
	Threaded sleeve, 4 pieces	UNC4-40/M3x6	533000	
	Adapter cable M12, 5-pin at socket Mini-USB and controller software	NEFC-M12G5-0.3-U1G5	547432	
User documentation				
	User documentation for bus node CPX-FB13	German	P.BE-CPX-FB13-DE	526427
		English	P.BE-CPX-FB13-EN	526428
		Spanish	P.BE-CPX-FB13-ES	526429
		French	P.BE-CPX-FB13-FR	526430
		Italian	P.BE-CPX-FB13-IT	526431
		Swedish	P.BE-CPX-FB13-SV	526432

Terminal CPX

Technical data – Bus node CPX-FB14



Bus node for handling communication between the electrical CPX terminal and a CANopen network master or CANopen network.

The bus node receives system supply from the interlinking block and processes communication via the I/O modules.

The status of the CPX terminal is displayed as a common message via 4 CPX-specific LEDs.

The different CANopen statuses and the fieldbus communication status are displayed via 3 additional LEDs.



Application

Bus connection		
The bus connection is established via a 9-pin Sub-D plug (pin) as per the CAN in Automation (CiA) specification DS 102 with additional 24 V CAN transceiver supply (option as per DS 102).	The bus connector plug (with protection class IP65/IP67 from Festo or IP20 from other manufacturers) facilitates the connection of an incoming and an outgoing bus cable.	There are 4 contacts available for the 4 wires (CAN_L, CAN_H, 24 V, 0 V) of the incoming and outgoing bus cables.

CANopen implementation			
The CPX-FB14 supports the CANopen protocol in accordance with the specifications DS 301 V4.01 and DS 401 V2.0. Implementation is based on the CiA Pre-defined Connection Set. There are 4 PDOs available for fast I/O data exchange.	Advanced system information can also be accessed by means of SDO communication. SDO communication also facilitates parameterisation before network startup or while the controller is running via the user program. An example of this is access to the integrated diagnostic memory function, i.e. storage of the last 40 errors with timestamp, module, channel and error type.	With its address capacity, the CPX-FB14 supports a large number of I/O module configurations, including pneumatic interface. By default, 8 byte digital inputs and 8 byte digital outputs can be addressed via PDO 1.	8 analogue input channels and 8 analogue output channels can be addressed via PDO 2 and 3. Status and diagnostic information can be evaluated via PDO 4. Additional 8 byte digital inputs and outputs as well as 8 analogue input and output channels can be addressed via mapping.

Special features in combination with CPX-FEC			
When a fieldbus node is combined with a CPX-FEC (in the fieldbus remote controller operating mode), the connected I/Os and/or valves, sensors and actuators are actuated via the CPX-FEC.	In this case, the fieldbus node only provides the communication interface to the PLC. Communication between CPX-FEC and CPX fieldbus node takes place via interlinking of the CPX modules.	The CPX-FEC occupies an address capacity of the CPX fieldbus node of: <ul style="list-style-type: none">• 8 byte outputs• 8 byte inputs As no other components (e.g. I/O modules) are actuated via the CPX fieldbus node, its address capacity is thus reduced effectively to an 8 byte I/O.	The full address capacity of the CPX-FEC is available for actuation of the peripherals: <ul style="list-style-type: none">• 64 byte inputs• 64 byte outputs

Terminal CPX

Technical data – Bus node CPX-FB14

FESTO

General technical data			
Type	CPX-FB14		
Part No.	526174		
Fieldbus interface	Sub-D pin, 9-pin (to DS 102) Bus interface galvanically isolated via optocoupler 24 V supply CAN interface via bus		
Baud rates	[kbps]	125, 250, 500 and 1000 can be set via DIL switch	
Addressing range	Node ID 1 ... 127 Set using DIL switch		
Product family	Digital inputs and outputs		
Communication profile	DS 301, V4.01		
Device profile	DS 401, V2.0		
Number	PDO	4 Tx/4 Rx	
	SDO	1 server SDO	
Configuration support	EDS file and bitmaps		
Max. address capacity	Inputs	[Byte]	16 digital, 16 analogue channels
	Outputs	[Byte]	16 digital, 16 analogue channels
LED displays (bus-specific)	MS = Module status NS = Network status IO = I/O status		
Device-specific diagnostics	Via emergency message Object 1001, 1002 and 1003		
Parameterisation	Via SDO		
Additional functions	<ul style="list-style-type: none"> • Storage of the last 40 errors with timestamp (access via SDO) • 8 bit system status via transmit PDO 4 (default) • 2 byte inputs and 2 byte outputs, system diagnostics via PDO 4 • Minimum boot-up • Variable PDO mapping • Emergency message • Node guarding • Heart beat 		
Operating voltage	Nominal value	[V DC]	24
	Permissible range	[V DC]	18 ... 30
	Power failure bridging	[ms]	10
Current consumption	[mA]	Max. 200	
Protection class to EN 60529	IP65/IP67		
Temperature range	Operation	[°C]	-5 ... +50
	Storage/transport	[°C]	-20 ... +70
Materials	Polymer		
Grid dimension	[mm]	50	
Dimensions (including interlinking block) W x L x H	[mm]	50 x 107 x 50	
Weight	Without interlinking block	[g]	115
	Including interlinking block without power supply	[g]	195
	Including interlinking block with system supply	[g]	215

-  - Note

Please observe the general limits and guidelines for the system when configuring the electrical modules.

Terminal CPX

Technical data – Bus node CPX-FB14

Connection and display components



Pin allocation for the CANopen interface







Pin allocation	Pin	Signal	Description
Sub-D plug			
	1	n.c.	Not connected
	2	CAN_L	Received/transmitted data low
	3	CAN_GND	0 V CAN interface
	4	n.c.	Not connected
	5	CAN_Shld	Optional screened connection
	6	GND	Ground ¹⁾
	7	CAN_H	Received/transmitted data high
	8	n.c.	Not connected
	9	CAN_V+	24 V DC supply CAN interface
	Housing	Screened	Connection to FE (functional earth)
Bus connection Micro Style (M12)			
Incoming 	1	Screened	Connection to FE (functional earth)
	2	CAN_V+	24 V DC supply CAN interface
	3	CAN_GND	0 V CAN interface
	4	CAN_H	Received/transmitted data high
	5	CAN_L	Received/transmitted data low
Outgoing 	1	Screened	Connection to FE (functional earth)
	2	CAN_V+	24 V DC supply CAN interface
	3	CAN_GND	0 V CAN interface
	4	CAN_H	Received/transmitted data high
	5	CAN_L	Received/transmitted data low
Bus connection Open Style			
	1	CAN_GND	0 V CAN interface
	2	CAN_L	Received/transmitted data low
	3	Screened	Connection to FE (functional earth)
	4	CAN_H	Received/transmitted data high
	5	CAN_V+	24 V DC supply CAN interface

1) Connected internally via Pin 3

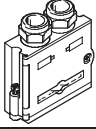
Terminal CPX

Accessories – Bus node CPX-FB14

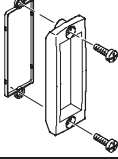
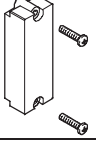
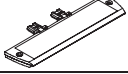
FESTO

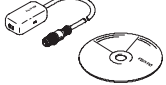
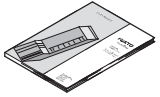
Ordering data				
Designation		Type	Part No.	
Bus connection				
	Sub-D plug	FBS-SUB-9-BU-2x5POL-B	532219	
	Bus connection Micro Style, 2xM12, 5-pin	FBA-2-M12-5POL	525632	
	Fieldbus socket for Micro Style connection, M12, 5-pin	FBSD-GD-9-5POL	18324	
	Plug for Micro Style connection, M12, 5-pin	FBS-M12-5GS-PG9	175380	
	Bus connection Open Style	FBA-1-SL-5POL	525634	
	Terminal strip connector for Open Style connection, 5-pin	FBSD-KL-2x5POL	525635	
	Inspection cover, transparent	AK-SUB-9/15-B	533334	
	Inspection cover, for use in Atex environments as per certification (→ 44)	AK-SUB-9/15	557010	
	Inscription label holder for connection block	CPX-ST-1	536593	
	Threaded sleeve, 4 pieces	UNC4-40/M3x6	533000	
	Adapter cable M12, 5-pin at socket Mini-USB and controller software	NEFC-M12G5-0.3-U1G5	547432	
User documentation				
	User documentation for bus node CPX-FB14	German	P.BE-CPX-FB14-DE	526409
		English	P.BE-CPX-FB14-EN	526410
		Spanish	P.BE-CPX-FB14-ES	526411
		French	P.BE-CPX-FB14-FR	526412
		Italian	P.BE-CPX-FB14-IT	526413
		Swedish	P.BE-CPX-FB14-SV	526414

Terminal CPX

Technical data – Bus node CPX-FB23



Bus node for handling communication between the electrical CPX terminal and a higher-order master for Control & Communication-Link (CC-Link) from Mitsubishi.

The bus node receives system supply from the interlinking block and processes communication via the I/O modules.

The status of the CPX terminal is displayed as a common message via 4 CPX-specific LEDs.

The fieldbus communication status is displayed via 4 CC-Link-specific LEDs.



Application

Bus connection

The bus connection can be selected when ordering and is established by means of a screw terminal with IP20 protection, a Sub-D plug with IP65/IP67 protection from Festo or IP20 protection from other manufacturers.

Both connection types have the function of an integrated T-distributor and thus support the connection of an incoming and outgoing bus cable.

The integrated interface with RS 485 transmission technology is designed for the typical CC-Link 3-wire connection technology (in accordance with CLPA CC-Link Spec. V1.1).

CC-Link implementation

The CPX-FB23 supports max. 4 stations per slave. The number of stations used can be set by means of DIL switch. Synchronous data transmission for digital and analogue I/Os is

conducted using the bit and word ranges (Rx/Ry/RWr/RWw). The CPX-FB23 supports an address space of max. 64 digital inputs and 64 digital outputs (Rx/Ry) or up to

16 analogue inputs and 16 analogue outputs (RWr/RWw). Mixed operation of digital and analogue inputs/outputs is possible.

Example:
Station 1 + 2 = 32 digital inputs and 32 digital outputs,
Station 3 = 4 analogue inputs and 4 analogue outputs

Special features in combination with CPX-FEC

When a fieldbus node is combined with a CPX-FEC (in the fieldbus remote controller operating mode), the connected I/Os and/or valves, sensors and actuators are actuated via the CPX-FEC.

In this case, the fieldbus node only provides the communication interface to the PLC. Communication between CPX-FEC and CPX fieldbus node takes place via interlinking of the CPX modules.

The CPX-FEC occupies an address capacity of the CPX fieldbus node of:

- 8 byte outputs
- 8 byte inputs

As no other components (e.g. I/O modules) are actuated via the CPX fieldbus node, its address capacity is thus reduced effectively to an 8 byte I/O.

The full address capacity of the CPX-FEC is available for actuation of the peripherals:

- 64 byte inputs
- 64 byte outputs

Terminal CPX

Technical data – Bus node CPX-FB23

FESTO

General technical data			
Type	CPX-FB23		
Part No.	526176		
Fieldbus interface	Either <ul style="list-style-type: none"> • Sub-D socket, 9-pin • Bus connection screw terminal, IP20 		
Baud rates	[kbps]	156 ... 10,000	
Addressing range	1 ... 64 Set using DIL switch		
No. of stations per slave	1, 2, 3 or 4 stations Set using DIL switch		
Vendor code	0x0177		
Machine type	0x3C		
Communication types	Synchronous communication		
Configuration support	-		
Max. address capacity, inputs	digital	Station 1, 2, 3, 4 = 64 Rx	
	analogue	Station 1, 2, 3, 4 = 16 RWr	
Max. address capacity, outputs	digital	Station 1, 2, 3, 4 = 64 Ry	
	analogue	Station 1, 2, 3, 4 = 16 RWw	
LED displays (bus-specific)	RUN = Data communication OK ERROR = CRC error or data communication error SD = Send data RD = Receive data		
Device-specific diagnostics	<ul style="list-style-type: none"> • 8 bit system status in image table for inputs • 2 byte inputs and 2 byte outputs, system diagnostics in image table 		
Parameterisation	Hold/clear by means of DIL switch		
Additional functions	Storage of the last 40 errors with timestamp (access via system diagnostics)		
Operating voltage	Nominal value	[V DC]	24
	Permissible range	[V DC]	18 ... 30
	Power failure bridging	[ms]	10
Current consumption		[mA]	Max. 200
Protection class to EN 60529	IP65/IP67		
Temperature range	Operation	[°C]	-5 ... +50
	Storage/transport	[°C]	-20 ... +70
Materials	Polymer		
Grid dimension		[mm]	50
Dimensions (including interlinking block) W x L x H		[mm]	50 x 107 x 50
Weight	Without interlinking block	[g]	115
	Including interlinking block without power supply	[g]	195
	Including interlinking block with system supply	[g]	215

-  - Note

Please observe the general limits and guidelines for the system when configuring the electrical modules.

Terminal CPX

Technical data – Bus node CPX-FB23

Connection and display components

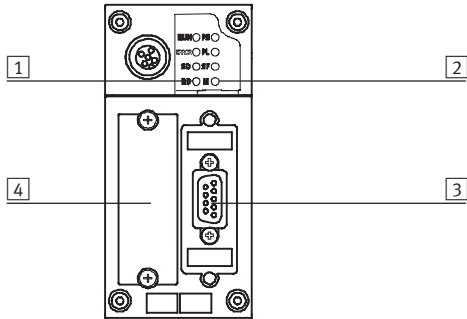

- 1 Bus-specific status LEDs
- 2 CPX-specific status LEDs
- 3 Fieldbus connection (9-pin Sub-D, socket)
- 4 DIL switch cover

Pin allocation for the CC-Link interface





Pin allocation	Pin	Signal	Description
Sub-D plug			
	1	n.c.	Not connected
	2	DA	Data A
	3	DG	Data reference potential
	4	n.c.	Not connected
	5	FE ¹⁾	Functional earth
	6	n.c.	Not connected
	7	DB	Data B
	8	n.c.	Not connected
	9	n.c.	Not connected
	Housing	SLD	Screening
Bus connection screw terminal			
	1	FG	Functional earth/housing
	2	SLD	Screening
	3	DG	Data reference potential
	4	DB	Data B
	5	DA	Data A

1) Via RC element on housing

Terminal CPX

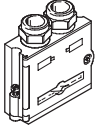
Accessories – Bus node CPX-FB23

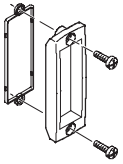
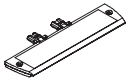
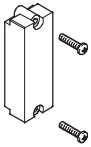
FESTO

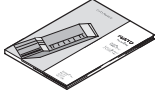
Ordering data				
Designation		Type	Part No.	
Bus connection				
	Sub-D plug	FBS-SUB-9-GS-2x4POL-B	532220	
	Bus connection screw terminal	FBA-1-KL-5POL	197962	
	Inspection cover, transparent	AK-SUB-9/15-B	533334	
	Inscription label holder for connection block	CPX-ST-1	536593	
	Inspection cover, for use in Atex environments as per certification (→ 44)	AK-SUB-9/15	557010	
	Threaded sleeve, 4 pieces	UNC4-40/M3x6	533000	
	Adapter cable M12, 5-pin at socket Mini-USB and controller software	NEFC-M12G5-0.3-U1G5	547432	
User documentation				
	User documentation for bus node CPX-FB23	German	P.BE-CPX-FB23-DE	526403
		English	P.BE-CPX-FB23-EN	526404

Terminal CPX

Technical data – Bus node CPX-FB32



IT services:



Bus node for handling communication between the electrical CPX terminal and the Ethernet/IP network.

The bus node receives system supply from the interlinking block and processes communication via the I/O modules.

The status of the CPX terminal is displayed as a common message via 4 CPX-specific LEDs.



Application
Bus connection

The bus connection is established via an M12 plug, D-coded to IEC947-5-2 with protection class IP65/67.

Ethernet/IP is an open bus system based on the Ethernet standard and TCP/IP technology (IEEE802.3).

Ethernet/IP implementation

The CPX-FB32 supports the two remote I/O and remote controller operating modes. In remote I/O operating mode, all functions of the CPX valve terminal are

directly controlled by the Ethernet/IP master (host). In addition to having control via a bus system, it is possible to use IT technol-

ogies. An integrated web server enables diagnostic data to be visualised via HTML. Various programs support direct access to the data of the device

from the automation network. The Ethernet/IP node for CPX supports the transmission technology that conforms to DIN EN 50173/CAT 5.

Special features in combination with CPX-FEC

When a fieldbus node is combined with a CPX-FEC (in the fieldbus remote controller operating mode), the connected I/Os and/or valves, sensors and actuators are actuated via the CPX-FEC.

In this case, the fieldbus node only provides the communication interface to the PLC.

Communication between CPX-FEC and CPX fieldbus node takes place via interlinking of the CPX modules.

The CPX-FEC occupies an address capacity of the CPX fieldbus node of:

- 8 byte inputs/outputs or
- 16 byte inputs/outputs

Terminal CPX

Technical data – Bus node CPX-FB32

FESTO

General technical data			
Type	CPX-FB32		
Part No.	541302		
Fieldbus interface	Plug connector, M12, D-coded, 4-pin		
Baud rates	[Mbps]	10/100, full/half duplex	
IP addressing	Via DHCP, DIL switch or network software		
Max. address capacity, inputs	[Byte]	64	
Max. address capacity, outputs	[Byte]	64	
LED displays (bus-specific)	MS = Module status NS = Network status IO = I/O status TP = Link/Traffic		
Device-specific diagnostics	System, module and channel oriented diagnostics		
Parameterisation	<ul style="list-style-type: none"> Start-up parameterisation Asynchronous parameterisation via Explicit Messaging 		
Additional functions	<ul style="list-style-type: none"> Storage of the last 40 errors with timestamp (access via system diagnostics) 8 bit system status in image table for inputs 2 byte I/O, system diagnostics via image table 		
Operating voltage	Nominal value	[V DC]	24
	Permissible range	[V DC]	18 ... 30
	Power failure bridging	[ms]	10
Current consumption		[mA]	Typically 65
Protection class to EN 60529	IP65/IP67		
Temperature range	Operation	[°C]	- 5... +50
	Storage/transport	[°C]	-20 ... +70
Materials	Polymer		
Grid dimension		[mm]	50
Dimensions (including interlinking block) W x L x H		[mm]	50 x 107 x 50
Weight	Without interlinking block	[g]	125
	Including interlinking block without power supply	[g]	215
	Including interlinking block with system supply	[g]	225

-  - Note

Please observe the general limits and guidelines for the system when configuring the electrical modules.

Terminal CPX

Technical data – Bus node CPX-FB32

Connection and display components

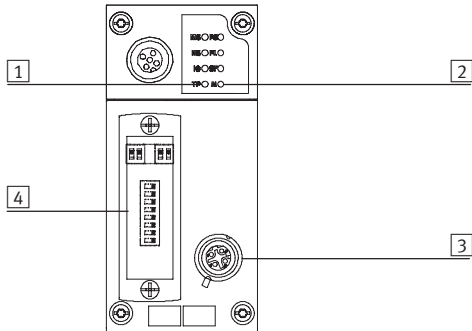

- 1 Bus-specific status LEDs
- 2 CPX-specific status LEDs
- 3 Fieldbus connection
(4-pin socket, M12, D-coded)
- 4 Transparent DIL switch cover

Pin allocation for the fieldbus interface

Pin allocation	Pin	Signal	Description
M12 socket, D-coded			
	1	TD+	Transmitted data+
	2	RD+	Received data+
	3	TD-	Transmitted data-
	4	RD-	Received data-
	Housing		

Terminal CPX

Accessories – Bus node CPX-FB32

FESTO

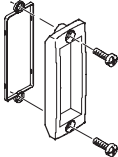
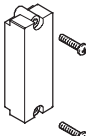
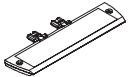
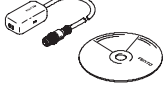
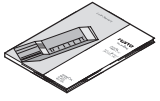
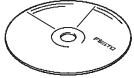
Ordering data				
Designation		Type	Part No.	
Bus connection				
	Plug, M12x1, 4-pin, D-coded	NECU-M-S-D12G4-C2-ET	543109	
	Inspection cover, transparent	AK-SUB-9/15-B	533334	
	Inspection cover, for use in ATEX environments as per certification (→ 44)	AK-SUB-9/15	557010	
	Inscription label holder for connection block	CPX-ST-1	536593	
	Adapter cable M12, 5-pin at socket Mini-USB and controller software	NEFC-M12G5-0.3-U1G5	547432	
User documentation				
	User documentation for bus node CPX-FB32	German	P.BE-CPX-FB32-DE	693134
		English	P.BE-CPX-FB32-EN	693135
		Spanish	P.BE-CPX-FB32-ES	693136
		French	P.BE-CPX-FB32-FR	693137
		Italian	P.BE-CPX-FB32-IT	693138
		Swedish	P.BE-CPX-FB32-SV	693139
Software				
	CPX remote diagnostics and process visualisation	CPX-WEB-MONITOR	545413	

Terminal CPX

Technical data – Bus node CPX-FB33



Bus node for operating the CPX valve terminal on PROFINET IO.

The bus node receives system supply from the interlinking block and processes communication via the I/O modules.

The status of the CPX terminal is displayed as a common message via 4 CPX-specific LEDs.

The fieldbus communication status is displayed via three bus-specific LEDs.



Application

Bus connection

The bus connection is established via two M12 sockets, D-coded to IEC61076-2-101 with protection class IP65/67.

Both connections are equivalent 100BaseTX Ethernet ports with integrated Auto-MDI functionality

(crossover and patch cables can be used), which are merged via an internal switch.

- Maximum segment length 100 m
- Baud rate 100 Mbps

PROFINET implementation

The CPX-FB33 supports the PROFINET IO protocol on the basis of the Ethernet standard and TCP/IP technology to IEEE802.3. This ensures data transfer with a high baud rate, e.g. IO data of sensors, actuators or robot controllers, PLCs or process equipment. In addition,

non-real time critical information such as diagnostic information, configuration information, etc. can be transferred. The Ethernet bandwidth is sufficient to transfer both data types (real-time and non-real-time) in parallel.

The bus node features LEDs for the bus status and CPX peripherals information, as well as switching elements, memory stick and a diagnostic interface. The memory stick helps to ensure that the fieldbus node can be replaced quickly in the event of an error. With PROFINET the user has

access to all peripherals, diagnostic data and parameter data of the CPX valve terminal. The fieldbus node can be used as a remote I/O or remote controller. All information relevant to the CPX can be read out and changed depending on the function via an MMI.

Special features in combination with CPX-FEC

When a fieldbus node is combined with a CPX-FEC (in the fieldbus remote controller operating mode), the connected I/Os and/or valves, sensors and actuators are actuated via the CPX-FEC.

In this case, the fieldbus node only provides the communication interface to the PLC.

Communication between CPX-FEC and CPX fieldbus node takes place via interlinking of the CPX modules.

The CPX-FEC occupies an address capacity of the CPX fieldbus node of:

- 8 byte inputs/outputs

Terminal CPX

Technical data – Bus node CPX-FB33

General technical data			
Type	CPX-FB33		
Part No.	548755		
Fieldbus interface	Two plug connectors, M12, D-coded, 4-pin		
Baud rates	[Mbps]	100	
Max. address capacity, inputs	[Byte]	64	
Max. address capacity, outputs	[Byte]	64	
LED displays (bus-specific)	NF = Network fault TP1 = Link/Traffic TP1 TP2 = Link/Traffic TP2		
Device-specific diagnostics	<ul style="list-style-type: none"> • Channel and module-oriented diagnostics • Undervoltage of modules • Diagnostic memory 		
Parameterisation	<ul style="list-style-type: none"> • System parameters • Diagnostic behaviour • Signal setup • Failsafe response • Forcing of channels 		
Additional functions	<ul style="list-style-type: none"> • Start-up parameterisation in clear text via fieldbus • Channel-related diagnostics via fieldbus • Acyclic data access via fieldbus and via Ethernet • System status can be represented using process data • Additional diagnostics interface for control unit 		
Operating voltage	Nominal value	[V DC]	24
	Permissible range	[V DC]	18 ... 30
	Power failure bridging	[ms]	10
Current consumption	[mA]	Maximum 150	
Protection class to EN 60529	IP65/IP67		
Temperature range	Operation	[°C]	-5 ... +50
	Storage/transport	[°C]	-20 ... +70
Materials	Top cover	Aluminium	
	Seals	Nitrile rubber	
	Cover caps	Polyamide	
	Screws	Galvanised steel	
Grid dimension	[mm]	50	
Dimensions (including interlinking block) W x L x H	[mm]	50 x 107 x 50	
Weight	Without interlinking block	[g]	280

 Note

Please observe the general limits and guidelines for the system when configuring the electrical modules.

 Note

Use the right kind of screws for the type of interlinking block (metal or plastic):

- Self-tapping screws for plastic interlinking blocks

- Screws with metric thread for metal interlinking blocks

Terminal CPX

Technical data – Bus node CPX-FB33

Connection and display components

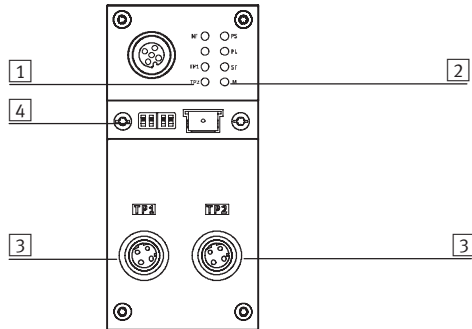



- 1 Bus-specific status LEDs
- 2 CPX-specific status LEDs
- 3 Fieldbus connection
(4-pin socket, M12, D-coded)
- 4 Transparent cover for DIL switch
and memory card

Pin allocation for the fieldbus interface

Pin allocation	Pin	Signal	Description
M12 socket, D-coded			
	1	TD+	Transmitted data+
	2	RD+	Received data+
	3	TD-	Transmitted data-
	4	RD-	Received data-
	Housing		

Terminal CPX

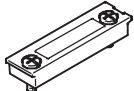
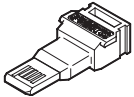
Accessories – Bus node CPX-FB33

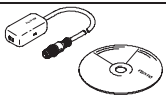
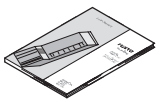
Ordering data				
Designation		Type	Part No.	
Bus connection				
	Plug, M12x1, 4-pin, D-coded	NECU-M-S-D12G4-C2-ET	543109	
	Transparent cover for DIL switch and memory card	CPX-AK-P	548757	
	Memory card	CPX-SK	549526	
	Cover cap for sealing unused bus connections (10 pieces)	ISK-M12	352059	
	Screws for mounting an inscription label on fieldbus node (12 pieces)	CPX-M-M2,5X6-12X	550222	
	Adapter cable M12, 5-pin at socket Mini-USB and controller software	NEFC-M12G5-0.3-U1G5	547432	
User documentation				
	User documentation for bus node CPX-FB33	German	P.BE-CPX-PNIO-DE	548759
		English	P.BE-CPX-PNIO-EN	548760
		Spanish	P.BE-CPX-PNIO-ES	548761
		French	P.BE-CPX-PNIO-FR	548762
		Italian	P.BE-CPX-PNIO-IT	548763
		Swedish	P.BE-CPX-PNIO-SV	548764

Terminal CPX

Technical data – Bus node CPX-FB34



Bus node for operating the CPX valve terminal on PROFINET IO.

The bus node is provided with system supply via the interlinking block and processes communication via the I/O modules.

The status of the CPX terminal is displayed as a common message via four CPX-specific LEDs.

The fieldbus communication status is displayed via three bus-specific LEDs.



Application

Bus connection

The bus connection is established via two RJ45 push-pull sockets to IEC61076-3-106 and IEC60603 with IP65/67 protection.

Both connections are equivalent 100BaseTX Ethernet ports with integrated auto MDI functionality

(cross-over and patch cables can be used) that are brought together via an internal switch.

- Maximum segment length 100 m
- Transmission rate 100 MBit/s

PROFINET implementation

The CPX-FB34 supports the PROFINET IO protocol based on the Ethernet standard and the TCP/IP technology to IEEE802.3. This guarantees data exchange with a high data transmission rate, for example I/O data from sensors, actuators or robot controllers, PLCs or

process equipment. Furthermore, non real-time critical information such as diagnostic information, configuration information, etc. can be transferred. The Ethernet bandwidth is sufficient to transmit both data types (real-time and non real-time) in parallel.

The bus node features LEDs for bus status and CPX peripheral information as well as switch elements, memory stick and a diagnostic interface. The purpose of the memory stick is to guarantee fast replacement of the fieldbus node in the event of an error. PROFINET provides the user with

access to all peripherals, diagnostic data and parameter data of the CPX valve terminal. The fieldbus node can be used as a remote I/O or remote controller. All information relevant to the CPX can be read out and, depending on the function, changed via an MMI.

Special features in combination with CPX-FEC

When a fieldbus node is combined with a CPX-FEC (in the fieldbus remote controller operating mode), the connected I/Os and/or valves, sensors and actuators are actuated via the CPX-FEC.

In this case, the fieldbus node only provides the communication interface to the PLC.

Communication between CPX-FEC and CPX fieldbus nodes takes place via interlinking of the CPX modules.

The CPX-FEC occupies an address capacity of the CPX fieldbus node of:

- 8 byte inputs/outputs

Terminal CPX

Technical data – Bus node CPX-FB34

General technical data			
Type	CPX-FB34		
Part No.	548751		
Fieldbus interface	2x RJ45 push-pull socket, AIDA		
Baud rates	[MBit/s]	100	
Protocol	ProfiNet RT		
Max. address capacity	Inputs	[Byte]	64
	Outputs	[Byte]	64
LED displays	(bus-specific)	NF = Network fault TP1 = Network active port 1 TP2 = Network active port 2	
	(product-specific)	M = Modify, parameterisation PL = Load supply PS = Electronic supply, sensor supply SF = System fault	
Device-specific diagnostics	<ul style="list-style-type: none"> Channel and module-oriented diagnostics Undervoltage of modules Diagnostic memory 		
Configuration support	GSDML file		
Parameterisation	<ul style="list-style-type: none"> System parameters Diagnostic behaviour Signal setup Failsafe response Forcing of channels 		
Additional functions	<ul style="list-style-type: none"> Start-up parameterisation in clear text via fieldbus Channel-related diagnostics via fieldbus Acyclic data access via fieldbus and via Ethernet System status can be represented using process data Additional diagnostics interface for contronr unit 		
Control elements	DIL switch, optional memory card		
Operating voltage	Nominal value	[V DC]	24
	Permissible range	[V DC]	18 ... 30
Intrinsic current consumption at nominal operating voltage	[mA]	Typically 120	
Protection class to EN 60529	IP65, IP67		
CE mark (see declaration of conformity)	In accordance with EU-EMC directive		
Temperature range	Operation	[°C]	- 5 ... +50
	Storage/transport	[°C]	-20 ... +70
Material of housing (see declaration of conformity)			
Grid dimension	[mm]	50	
Dimensions (incl. interlinking block) W x L x H	[mm]	50 x 107x 80	
Weight	Without interlinking block	[g]	280

 - Note

Please observe the general limits and guidelines for the system when configuring the electrical modules.

 - Note

Always use screws appropriate to the interlinking block (metal or plastic):

- Self-tapping screws for plastic interlinking blocks
- Screws with metric thread for metal interlinking blocks

Terminal CPX

Technical data – Bus node CPX-FB34

Connection and display components

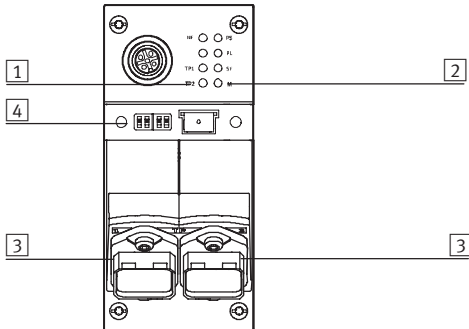



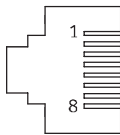

- 1 Bus-specific status LEDs
- 2 CPX-specific status LEDs
- 3 Fieldbus connection (8-pin RJ45 socket)
- 4 DIL switch and memory card

Pin allocation for the fieldbus interface

Pin allocation	Pin	Signal	Description
Plug RJ45			
	1	TD+	Transmitted data+
	2	TD-	Transmitted data-
	3	RD+	Received data+
	4	n.c.	Not connected
	5	n.c.	Not connected
	6	RD-	Received data-
	7	n.c.	Not connected
	8	n.c.	Not connected
	Housing	Screen	Screened

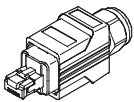
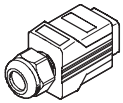
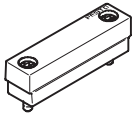
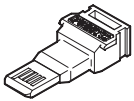
Terminal CPX

Accessories – Bus node CPX-FB34

Ordering data				
Designation		Type	Part No.	
Bus connection				
	Plug RJ45, 8-pin, push-pull	FBS-RJ45-PP-GS	552000	
	Cover cap for bus connection	CPX-M-AK-C	548753	
	Cover plate for DIL switch and memory card	CPX-M-AK-M	548754	
	Memory card	CPX-SK	549526	
	Screws for attaching an inscription label holder to the fieldbus node (12 pieces)	CPX-M-M2,5X6-12X	550222	
	Adapter cable M12, 5-pin at socket Mini-USB and controller software	NEFC-M12G5-0.3-U1G5	547432	
User documentation				
	Electronics manual, CPX bus node, type CPX-FB34	German	P.BE-CPX-PNIO-DE	548759
		English	P.BE-CPX-PNIO-EN	548760
		Spanish	P.BE-CPX-PNIO-ES	548761
		French	P.BE-CPX-PNIO-FR	548762
		Italian	P.BE-CPX-PNIO-IT	548763
		Swedish	P.BE-CPX-PNIO-SV	548764

Terminal CPX

Technical data – Bus node CPX-FB38



Bus node for operating the CPX valve terminal on EtherCAT.

The bus node is provided with system supply via the interlinking block and processes communication with the I/O modules.

The status of the CPX terminal is displayed as a common message via four CPX-specific LEDs.

The fieldbus communication status is displayed via four bus-specific LEDs.



Application

Bus connection

The bus connection is established via two M12 sockets, D-coded to IEC61076-2-101 with protection class IP65/67.

Both connections are equivalent 100BaseTX Ethernet ports with integrated auto MDI functionality

(cross-over and patch cables can be used) that are brought together via an internal switch.

- Maximum segment length 100 m
- Transmission rate 100 Mbps

EtherCAT implementation

The CPX-FB38 supports the EtherCAT protocol based on the Ethernet standard and the TCP/IP technology to IEEE802.3.

This guarantees data exchange with a high data transmission rate, for example I/O data from sensors,

actuators or robot controllers, PLCs or process equipment. Furthermore, non real-time critical information such as diagnostic information, configuration information, etc. can be transferred. The data bandwidth is sufficient to

transmit both data types (real-time and non real-time) in parallel.

The bus node features LEDs for bus status and CPX peripheral information as well as switch elements and a

diagnostic interface. The fieldbus node can be used as a remote I/O or remote controller. All information relevant to the CPX can be read out and, dependent on the function, changed via an MMI/FMT.

Special features in combination with CPX-FEC

When a fieldbus node is combined with a CPX-FEC (in the fieldbus remote controller operating mode), the connected I/Os and/or valves, sensors and actuators are actuated via the CPX-FEC.

In this case, the fieldbus node only provides the communication interface to the PLC.

Communication between CPX-FEC and CPX fieldbus nodes takes place via interlinking of the CPX modules.

The CPX-FEC occupies an address capacity of the CPX fieldbus node of:

- 8 byte inputs/outputs

Terminal CPX

Technical data – Bus node CPX-FB38

General technical data			
Type	CPX-FB38		
Part No.	552046		
Fieldbus interface	Two plug connectors M12, D-coded, 4-pin		
Baud rates	[Mbps]	100	
Max. address capacity, inputs	[byte]	64	
Max. address capacity, outputs	[byte]	64	
LED displays	bus-specific	Error = Communication error L/A1 = Network active port 1 L/A2 = Network active port 2 Run = Communication status	
	product-specific	M = Modify, parameterisation PL = Load supply PS = Electronic supply, sensor supply SF = System fault	
Device-specific diagnostics	<ul style="list-style-type: none"> • Channel and module-oriented diagnostics • Undervoltage of modules • Diagnostic memory 		
Configuration support	XML file		
Parameterisation	<ul style="list-style-type: none"> • System parameters • Diagnostic behaviour • Signal setup • Fail-safe response • Forcing of channels 		
Additional functions	<ul style="list-style-type: none"> • System status can be represented using process data • Additional diagnostic interface for operator units 		
Control elements	DIL switch		
Operating voltage	Nominal value	[V DC]	24
	Permissible range	[V DC]	18 ... 30
	Power failure bridging	[ms]	10
Current consumption		[mA]	Typically 100
Protection class to EN 60529	IP65/IP67		
CE mark (see declaration of conformity)	To EU EMC Directive		
Temperature range	Operation	[°C]	- 5 ... +50
	Storage/transport	[°C]	-20 ... +70
Materials	Housing	Reinforced polyamide	
Grid dimension		[mm]	50
Dimensions (incl. interlinking block) W x L x H		[mm]	50 x 107 x 50
Weight	without interlinking block	[g]	125

 Note

Please observe the general limits and guidelines for the system when configuring the electrical modules.

 Note

Always use screws appropriate to the interlinking block (metal or plastic):

- Self-tapping screws for plastic interlinking blocks
- Screws with metric thread for metal interlinking blocks

Terminal CPX

Technical data – Bus node CPX-FB38

Connection and display components

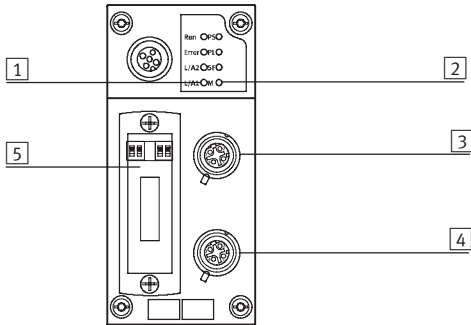

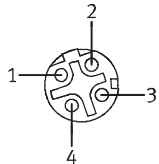

- 1 Bus-specific status LEDs
- 2 CPX-specific status LEDs
- 3 Fieldbus connection, output (4-pin socket, M12, D-coded)
- 4 Fieldbus connection, input (4-pin socket, M12, D-coded)
- 5 Transparent DIL switch cover

Pin allocation for the fieldbus interface

Pin allocation	Pin	Signal	Description
M12 socket, D-coded			
	1	TD+	Transmitted data+
	2	RD+	Received data+
	3	TD-	Transmitted data-
	4	RD-	Received data-
	Housing		

Terminal CPX

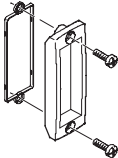
Accessories – Bus node CPX-FB38

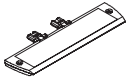
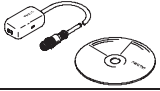
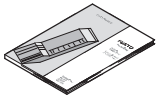
Ordering data				
Designation		Type	Part No.	
Bus connection				
	Plug M12x1, 4-pin, D-coded	NECU-M-S-D12G4-C2-ET	543109	
	Inspection cover, transparent	AK-SUB-9/15-B	533334	
	Cover cap for sealing unused bus connections (10 pieces)	ISK-M12	165592	
	Inscription label holder for connection block	CPX-ST-1	536593	
	Adapter cable from 5-pin M12 to mini USB socket and controller software	NEFC-M12G5-0.3-U1G5	547432	
User manual				
	Electronics manual, CPX bus node, type CPX-FB38	German	P.BE-CPX-FB38-DE	562524
		English	P.BE-CPX-FB38-EN	562525
		Spanish	P.BE-CPX-FB38-ES	562526
		French	P.BE-CPX-FB38-FR	562527
		Italian	P.BE-CPX-FB38-IT	562528
		Swedish	P.BE-CPX-FB38-SV	562529

Terminal CPX

Technical data – CPX-CP interface

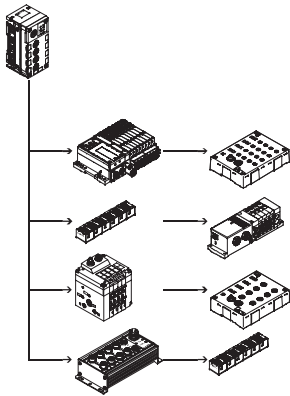

The CPX-CP electrical interface establishes the connection to CP modules of the CPI installation system via prefabricated cables. The I/O data of the connected valve terminals with CP string extension and CP input and output modules is transferred to the connected CPX bus node and thus via fieldbus to the higher-order controller. This enables the establishment of modular centralised and compact decentralised concepts with one system. The CP electrical interface is supported by all CPX fieldbus nodes and the CPX-FEC.



Application

CP connection

As well as transmitting the communication data, the max. 4 CP strings of a CPX-CP interface also transmit the supply voltage to the connected sensors and the load supply to the valves (or outputs). Both circuits are supplied with 24 V separately from

one another, but with a common reference potential. The valve terminals with CP string extension (or outputs) are supplied with voltage for the electronics and valves by the interlinking block.

The following combinations are made possible by the CP interface:

- Centralised analogue and digital inputs and outputs of the CPX terminal
- Decentralised digital inputs and

outputs of the CP installation system

- Valve/valve terminals that can be connected both centrally and decentrally

Configuration example – CP interface with CP modules

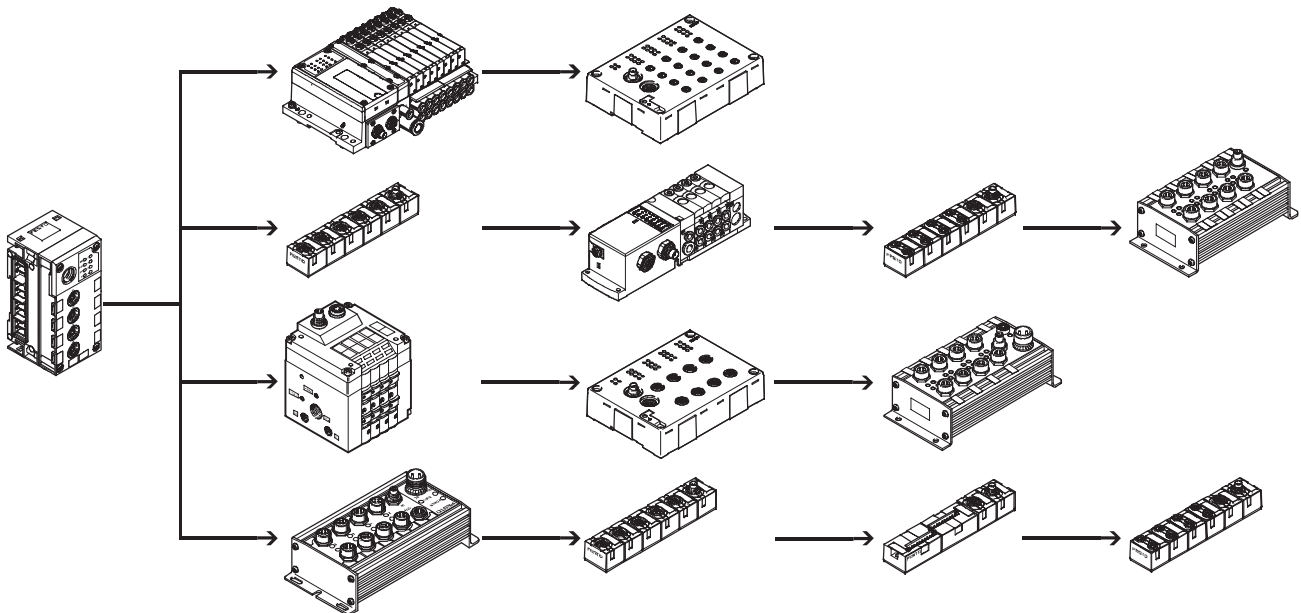

Terminal CPX

Technical data – CPX-CP interface

FESTO

Implementation

The CPX-CP interface supports the CPI system:

- Max. 4 individual electronically protected CP strings
- Max. 4 CP modules per string
- Max. 32 inputs/32 outputs per string
- The maximum length of a string is 10 m. If the CP interface is positioned centrally, the CP system can cover an area of 20 m in diameter
- Modules with CPI functionality

The following CP module variants are available:

- Input modules with 8 or 16 digital inputs (connection technology M8, M12 and CageClamp)
- Output modules with 4 or 8 digital outputs (connection technology M12)
- Valve terminals with CP string extension (up to 32 solenoid coils, different valve functions)

CPI modules support the following functions:

- Module-oriented diagnostics
- Module/channel-oriented parameterisation
- Support of all functions by the CPX-MMI operator unit
- Module can be positioned anywhere within the string

Several CP interface modules can be combined in one CPX terminal, depending on the address capacity of the bus node.

Example:

- CPX-FB13 (512 I/O)
- Max. 4 CP interface modules (128 I/O each) possible

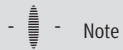

Note

When arranging the CP modules it should be taken into consideration that CP input modules without CPI functionality should always be placed at the end of a string.

Configuration

The following rules apply for a string of a CPX-CP interface:

- Max. one output module or one valve terminal without CPI functionality
- Max. one output module without CPI functionality or one valve terminal with CP string extension
- Any number of CP modules with CPI functionality, up to the maximum limit of 4 modules and/or 32 inputs/32 outputs per string

Maximum extension:

- 4 input modules and 4 valve terminals/output modules without CPI functionality
- 16 CP modules with CPI functionality

The configuration of the strings with respect to the module type and position of the modules in the string is entered by activating the SAVE key in the CPX-CP interface and saved there permanently (plug and work). Saved data is retained even when the CP interface is isolated from the voltage supply.

The representation of the CP interface within a CPX terminal and thus at the fieldbus is dependent on the characteristics of the relevant fieldbus system. In addition to input and output addressing, this also applies to the representation of the diagnostics and parameterisation of the CP module and the characteristics of the CPI system.

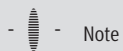

Note

The remanent saving of configuration data means that changes in the configuration or faulty modules are still displayed even after a voltage failure.

Terminal CPX

Technical data – CPX-CP interface

General technical data			
Type	CPX-CP-4-FB		
Part No.	526705		
Brief description		CP interface	
Max. number of	CP strings		4
	CP modules per string		4
	outputs per string		32
	inputs per string		32
CP connection		Socket M9, 5-pin	
Baud rate		[kbps]	1000
Cycle time	CP modules without CPI functionality	[ms]	4
	CP modules with CPI functionality	[ms]	2
LED displays		L1 ... 4 = Status of the CP string 1 ... 4 PS = Electronic supply, sensor supply PL = Load supply RN = Status of the CP system SF = System error	
Device-specific diagnostics		Via bus node	
Operating voltage	Nominal value	[V]	24 DC (reverse polarity protected)
	Permissible range	[V]	18 ... 30 DC
	Power failure bridging	[ms]	20
Supply voltage of sensors		[V]	24 DC \pm 25% coming from bus node
Load voltage of actuators		[V]	24 DC \pm 10% coming from bus node
Current consumption	without CP modules	[A]	Max. 0.2
	per CP string	[A]	Max. 1.6
Protection class to EN 60529		IP65/IP67	
Temperature range	Operation	[°C]	-5 ... +50
	Storage/transport	[°C]	-20 ... +70
Materials		Polyamide	
Grid dimension		[mm]	50
Dimensions (including interlinking block) W x L x H		[mm]	50 x 107 x 45
Weight	Without interlinking block	[g]	140
	Including interlinking block without power supply	[g]	220
	Including interlinking block with system supply	[g]	240

 Note

Please observe the general limits and guidelines for the system when configuring the electrical modules.

Terminal CPX

Accessories – CPX-CP interface



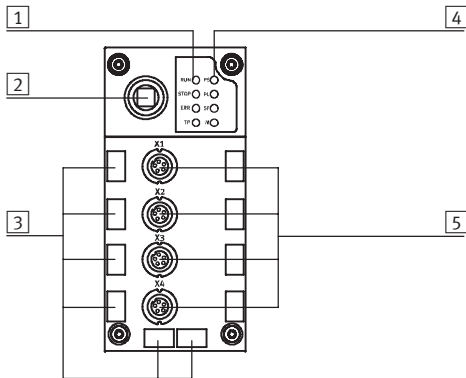

FESTO

Connection and display components

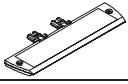

- 1 CP string LEDs
- 2 SAVE key
- 3 Holders for inscription labels (IBS 6x10)
- 4 CPX-specific status LEDs
- 5 CP connections for up to 4 strings (0 ... 3)

Ordering data

Designation		Type	Part No.	
Bus connection				
	Cover cap	M9	FLANSCHDOSE SER.712	356684
		M12	ISK-M12	165592
	Connecting cable WS-WD	0.25 m	KVI-CP-3-WS-WD-0,25	540327
		0.5 m	KVI-CP-3-WS-WD-0,5	540328
		2 m	KVI-CP-3-WS-WD-2	540329
		5 m	KVI-CP-3-WS-WD-5	540330
		8 m	KVI-CP-3-WS-WD-8	540331
	Connecting cable GS-GD	2 m	KVI-CP-3-GS-GD-2	540332
		5 m	KVI-CP-3-GS-GD-5	540333
		8 m	KVI-CP-3-GS-GD-8	540334
	Inscription label holder for connection block	CPX-ST-1		536593
User documentation				
	User documentation for CPX-CP interface	German	P.BE-CPX-CP-DE	539293
		English	P.BE-CPX-CP-EN	539294
		Spanish	P.BE-CPX-CP-ES	539295
		French	P.BE-CPX-CP-FR	539296
		Italian	P.BE-CPX-CP-IT	539297
		Swedish	P.BE-CPX-CP-SV	539298

Control block CPX-CMXX

Technical data

The control block CPX-CMXX is an intelligent module in the CPX terminal for controlling electric drive units. Individual axis and simple multi-axis applications can easily be implemented. Programming is not necessary. Configuration, parameterisation and commissioning of the application is easily achieved with the Festo Configuration Tool (FCT).

- Configuration of two axes groups with up to four axes each is possible
- There are 1024 position sets available per axes group
- Input or Teach-In of positions in specified set structure
- Parameterisation via Ethernet
- Communication protocol: FHPP-MAX, Festo handling and positioning profile for multi-axis movements.
- Control of drive units via CANopen



General technical data		
Protocol		FHPP-Max
Maximum address volume for inputs	[byte]	16
Maximum address volume for outputs	[byte]	16
LED displays (bus-specific)	RUN:	Program is executed
	STOP:	Program is stopped
	ERR:	Error in the program execution
	TP:	Status of Ethernet connection
LED displays (product-specific)	M:	Modify, parameterisation
	PS:	Electronic supply, sensor supply
Device-specific diagnostics	Diagnostic memory	
	Channel and module-oriented diagnostics	
	Undervoltage/short circuit of modules	
Parameterisation	System parameters	
Operating elements	Rotary switch for RUN/STOP	
Configuration support	Festo Configuration Tool (FCT)	
Additional functions	System status can be displayed using process data	
	Additional diagnostic interface for FCT	
Supported kinematic system	2-axis gantries (X-Z / Y-Z / X-Y)	
	3-axis gantries (X-Y-Z)	
Total number of axes	8	
Distribution of axes	2 groups with max. 4 axes	
Nominal operating voltage	[V DC]	24
Operating voltage range	[V DC]	18 ... 30
Power failure bridging	[ms]	10
Intrinsic current consumption at nominal operating voltage	[mA]	Typ. 85
Protection class to EN 60529	IP65/IP67	
Dimensions W x L x H (including interlinking block)	[mm]	50 x 107 x 55
Product weight	[g]	155
Materials		
Housing	Reinforced polyamide, polycarbonate	
Note on materials	RoHS-compliant	

Control block CPX-CMXX

Technical data

Technical data – Interfaces		
Ethernet		
Ethernet interface		Socket RJ45, 8-pin, for configuration only
Baud rate	[Mbit/s]	10/100
Interface		
Control interface		CAN bus
Baud rate	[Mbit/s]	1

Operating and environmental conditions		
Ambient temperature	[°C]	-5 ... +50
Storage temperature	[°C]	-20 ... +70
Certification		cULus listed (OL)
CE mark (see declaration of conformity)		To EU Low Voltage Directive

Connection and display components

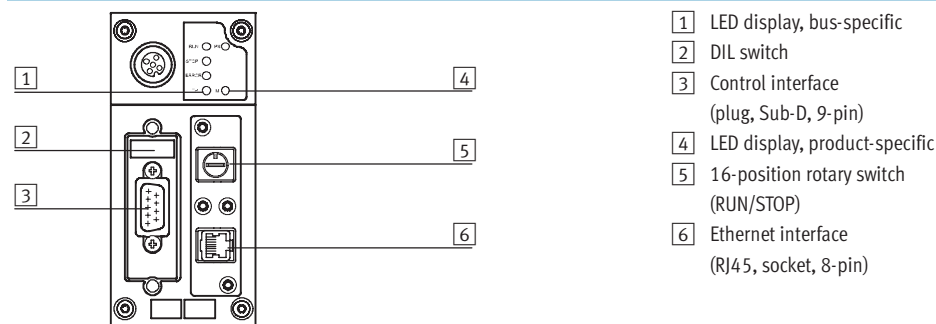

- 1 LED display, bus-specific
- 2 DIL switch
- 3 Control interface (plug, Sub-D, 9-pin)
- 4 LED display, product-specific
- 5 16-position rotary switch (RUN/STOP)
- 6 Ethernet interface (RJ45, socket, 8-pin)

Pin allocation – Control interface

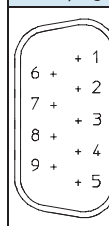
	Pin	Signal	Meaning
Sub-D plug			
	1	n.c.	Not connected
	2	CAN_L	CAN low
	3	CAN_GND	CAN ground
	4	n.c.	Not connected
	5	CAN_SHLD	Connection to functional earth (FE)
	6	CAN_GND	CAN ground (optional) ¹⁾
	7	CAN_H	CAN high
	8	n.c.	Not connected
	9	n.c.	Not connected
	Housing	Screened	Plug housing must be connected to FE

1) If a drive controller is connected to an external power supply, CAN ground (optional), pin 6, cannot be used on the CPX-CMXX.

Control block CPX-CMXX



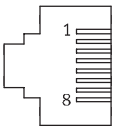

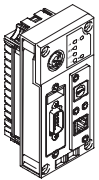



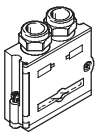

Technical data

Pin allocation – Ethernet interface			
	Pin	Signal	Meaning
Plug RJ45			
	1	TD+	Transmitted data+
	2	TD-	Transmitted data-
	3	RD+	Received data+
	4	n.c.	Not connected
	5	n.c.	Not connected
	6	RD-	Received data-
	7	n.c.	Not connected
	8	n.c.	Not connected
	Housing	Screened	Screened

Ordering data			
Designation	Part No.	Type	
	Control block	555667	CPX-CMXX

Control block CPX-CMXX

Accessories

Ordering data – Bus connection			
Designation		Part No.	Type
	Sub-D plug, 9-pin	532219	FBS-SUB-9-BU-2x5POL-B
	Bus connection, plug 2xM12, 5-pin	525632	FBA-2-M12-5POL
	Plug socket for fieldbus connection, M12, 5-pin	18324	FBSD-GD-9-5POL
	Plug M12, 5-pin	175380	FBS-M12-5GS-PG9
	Bus connection, 5-pin	525634	FBA-1-SL-5POL
	Bus connection, screw terminal, 5-pin	525635	FBSD-KL-2x5POL
	Plug RJ45, 8-pin	534494	FBS-RJ45-8-GS
	Cover for RJ45 connection	534496	AK-RJ45
	Inspection cover, transparent for plug/socket Sub-D	533334	AK-SUB-9/15-B
	Cover for plug/socket Sub-D	557010	AK-SUB-9/15
	Inscription label holder for connection block	536593	CPX-ST-1

Documentation			
Designation		Language	Part No. Type
	Description of control block CPX-CMXX	German	564221 P.BE-CPX-CMXX-DE
		English	564222 P.BE-CPX-CMXX-EN
	Description of Festo handling and positioning profile for multi-axis movements FHPP-MAX	German	564223 P.BE-CMXX-FHPP-SW-DE
		English	564224 P.BE-CMXX-FHPP-SW-EN

Terminal CPX

Technical data – Input module, digital

Function

Digital input modules enable the connection of two-wire and three-wire sensors (proximity sensors, inductive or capacitive sensors, etc).

Depending on the connection block selected, the module supports various connection concepts with different numbers of sockets (single or double allocation).

Application

- Input modules for 24 V DC sensor voltage supply
- PNP or NPN logic
- Supports connection blocks with M12, M8, Sub-D, Harax and terminal connection
- Module features can be parameterised
- The input module receives the voltage supply for the electronics and the sensors from the interlinking block
- Module protection and diagnostics through integrated electronic fuse protection



General technical data				CPX-4DE	CPX-8DE	CPX-8DE-D	CPX-8NDE
Type				195752	195750	541480	543813
Part No.							
No. of inputs				4	8	8	8
Max. power supply of inputs per module		[A]		0.7	1	0.7	0.7
Fuse protection				Internal electronic fuse protection for each module	Internal electronic fuse protection for each module	Internal electronic fuse protection for each channel	Internal electronic fuse protection for each module
Intrinsic current consumption at operating voltage		[mA]		Typ. 15			
Operating voltage	Nominal value	[V DC]		24			
	Permissible range	[V DC]		18 ... 30			
Galvanic isolation	Channel – Channel			No			
	Channel – Internal bus			No			
Switching level	Signal 0	[V DC]		≤ 5			≥ 11
	Signal 1	[V DC]		≥ 11			≤ 5
Switch-on debounce time		[ms]		3 (0.1 ms, 10, 20 parameterisable)			
Input characteristic curve				IEC 1131-2			
Switching logic				Positive logic (PNP)			Negative logic (NPN)
LED displays	Group diagnostics			1	1	1	1
	Channel diagnostics			–	–	8	–
	Channel status			4	8	8	8
Diagnostics				Short circuit/overload, per channel			
Parameterisation				<ul style="list-style-type: none"> • Module monitoring • Behaviour after short circuit • Switch-on debounce time • Signal stretching time 			
Protection class to EN 60529				Depending on connection block			
Temperature range	Operation	[°C]		–5 ... +50			
	Storage/transport	[°C]		–20 ... +70			
Materials				Reinforced polyamide, polycarbonate			
Grid dimension				[mm] 50			
Dimensions (including interlinking block and connection block)				[mm] 50 x 107 x 50			
W x L x H							
Weight				[g] 38			

Terminal CPX

Technical data – Input module, digital

Connection and display components

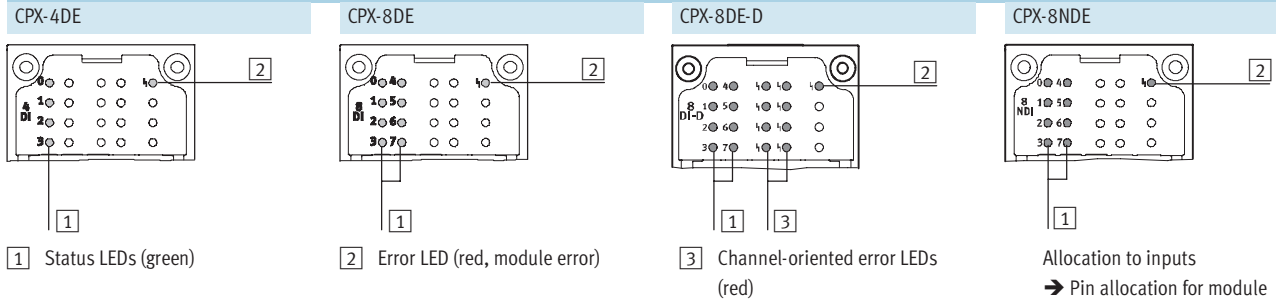

Connection block/digital input module combinations

Connection blocks	Part No.	Digital input modules			
		CPX-4DE	CPX-8DE	CPX-8DE-D	CPX-8NDE
CPX-AB-8-M8-3POL	195706	■	■	■	■
CPX-AB-4-M12X2-5POL	195704	■	■	■	■
CPX-AB-4-M12X2-5POL-R	541254	■	■	■	■
CPX-AB-8-KL-4POL	195708	■	■	■	■
CPX-AB-1-SUB-BU-25POL	525676	■	■	■	■
CPX-AB-4-HAR-4POL	525636	■	■	■	■
CPX-M-4-M12x2-5POL	549367	■	■	■	■
CPX-AB-4-M12x2-5P-R-M3	546997	■	■	■	■

Pin allocation

Connection block inputs	CPX-4DE	CPX-8DE, CPX-8DE-D and CPX-8NDE		
CPX-AB-8-M8-3POL	<p>X1.1: 24 V_{SEN} X1.3: 0 V_{SEN} X1.4: Input x</p> <p>X2.1: 24 V_{SEN} X2.3: 0 V_{SEN} X2.4: Input x+1</p> <p>X3.1: 24 V_{SEN} X3.3: 0 V_{SEN} X3.4: Input x+1</p> <p>X4.1: 24 V_{SEN} X4.3: 0 V_{SEN} X4.4: n.c.</p>	<p>X5.1: 24 V_{SEN} X5.3: 0 V_{SEN} X5.4: Input x+2</p> <p>X6.1: 24 V_{SEN} X6.3: 0 V_{SEN} X6.4: Input x+3</p> <p>X7.1: 24 V_{SEN} X7.3: 0 V_{SEN} X7.4: Input x+3</p> <p>X8.1: 24 V_{SEN} X8.3: 0 V_{SEN} X8.4: n.c.</p>	<p>X1.1: 24 V_{SEN x} X1.3: 0 V_{SEN x} X1.4: Input x</p> <p>X2.1: 24 V_{SEN x+1} X2.3: 0 V_{SEN x+1} X2.4: Input x+1</p> <p>X3.1: 24 V_{SEN x+2} X3.3: 0 V_{SEN x+2} X3.4: Input x+2</p> <p>X4.1: 24 V_{SEN x+3} X4.3: 0 V_{SEN x+3} X4.4: Input x+3</p>	<p>X5.1: 24 V_{SEN x+4} X5.3: 0 V_{SEN x+4} X5.4: Input x+4</p> <p>X6.1: 24 V_{SEN x+5} X6.3: 0 V_{SEN x+5} X6.4: Input x+5</p> <p>X7.1: 24 V_{SEN x+6} X7.3: 0 V_{SEN x+6} X7.4: Input x+6</p> <p>X8.1: 24 V_{SEN x+7} X8.3: 0 V_{SEN x+7} X8.4: Input x+7</p>
CPX-AB-4-M12X2-5POL and CPX-AB-4-M12X2-5POL-R ¹⁾	<p>X1.1: 24 V_{SEN} X1.2: Input x+1 X1.3: 0 V_{SEN} X1.4: Input x X1.5: FE</p> <p>X2.1: 24 V_{SEN} X2.2: n.c. X2.3: 0 V_{SEN} X2.4: Input x+1 X2.5: FE</p>	<p>X3.1: 24 V_{SEN} X3.2: Input x+3 X3.3: 0 V_{SEN} X3.4: Input x+2 X3.5: FE</p> <p>X4.1: 24 V_{SEN} X4.2: n.c. X4.3: 0 V_{SEN} X4.4: Input x+3 X4.5: FE</p>	<p>X1.1: 24 V_{SEN x} X1.2: Input x+1 X1.3: 0 V_{SEN x} X1.4: Input x X1.5: FE</p> <p>X2.1: 24 V_{SEN x+2} X2.2: Input x+3 X2.3: 0 V_{SEN x+2} X2.4: Input x+2 X2.5: FE</p>	<p>X3.1: 24 V_{SEN x+4} X3.2: Input x+5 X3.3: 0 V_{SEN x+4} X3.4: Input x+4 X3.5: FE</p> <p>X4.1: 24 V_{SEN x+6} X4.2: Input x+7 X4.3: 0 V_{SEN x+6} X4.4: Input x+6 X4.5: FE</p>

1) Speedcon quick lock, metal thread with additional screening

Terminal CPX







Technical data – Input module, digital

Pin allocation				
Connection block inputs		CPX-4DE	CPX-8DE, CPX-8DE-D and CPX-8NDE	
CPX-AB-8-KL-4POL				
	<p>X1.0: 24 V_{SEN} X1.1: 0 V_{SEN} X1.2: Input x X1.3: FE</p> <p>X2.0: 24 V_{SEN} X2.1: 0 V_{SEN} X2.2: Input x+1 X2.3: FE</p> <p>X3.0: 24 V_{SEN} X3.1: 0 V_{SEN} X3.2: Input x+1 X3.3: FE</p> <p>X4.0: 24 V_{SEN} X4.1: 0 V_{SEN} X4.2: n.c. X4.3: FE</p>	<p>X5.0: 24 V_{SEN} X5.1: 0 V_{SEN} X5.2: Input x+2 X5.3: FE</p> <p>X6.0: 24 V_{SEN} X6.1: 0 V_{SEN} X6.2: Input x+3 X6.3: FE</p> <p>X7.0: 24 V_{SEN} X7.1: 0 V_{SEN} X7.2: Input x+3 X7.3: FE</p> <p>X8.0: 24 V_{SEN} X8.1: 0 V_{SEN} X8.2: n.c. X8.3: FE</p>	<p>X1.0: 24 V_{SEN x} X1.1: 0 V_{SEN x} X1.2: Input x X1.3: FE</p> <p>X2.0: 24 V_{SEN x+1} X2.1: 0 V_{SEN x+1} X2.2: Input x+1 X2.3: FE</p> <p>X3.0: 24 V_{SEN x+2} X3.1: 0 V_{SEN x+2} X3.2: Input x+2 X3.3: FE</p> <p>X4.0: 24 V_{SEN x+3} X4.1: 0 V_{SEN x+3} X4.2: Input x+3 X4.3: FE</p>	<p>X5.0: 24 V_{SEN x+4} X5.1: 0 V_{SEN x+4} X5.2: Input x+4 X5.3: FE</p> <p>X6.0: 24 V_{SEN x+5} X6.1: 0 V_{SEN x+5} X6.2: Input x+5 X6.3: FE</p> <p>X7.0: 24 V_{SEN x+6} X7.1: 0 V_{SEN x+6} X7.2: Input x+6 X7.3: FE</p> <p>X8.0: 24 V_{SEN x+7} X8.1: 0 V_{SEN x+7} X8.2: Input x+7 X8.3: FE</p>
CPX-AB-1-SUB-BU-25POL				
	<p>1: Input x 2: Input x+1 3: Input x+1 4: n.c. 5: 24 V_{SEN} 6: 0 V_{SEN} 7: 24 V_{SEN} 8: 0 V_{SEN} 9: 24 V_{SEN} 10: 24 V_{SEN} 11: 0 V_{SEN} 12: 0 V_{SEN} 13: FE</p>	<p>14: Input x+2 15: Input x+3 16: Input x+3 17: n.c. 18: 24 V_{SEN} 19: 24 V_{SEN} 20: 24 V_{SEN} 21: 24 V_{SEN} 22: 0 V_{SEN} 23: 0 V_{SEN} 24: 0 V_{SEN} Socket: FE</p>	<p>1: Input x 2: Input x+1 3: Input x+2 4: Input x+3 5: 24 V_{SEN x+1} 6: 0 V_{SEN x+1} 7: 24 V_{SEN x+3} 8: 0 V_{SEN x+3} 9: 24 V_{SEN x} 10: 24 V_{SEN x+2} 11: 0 V_{SEN x} 12: 0 V_{SEN x+2} 13: FE</p>	<p>14: Input x+4 15: Input x+5 16: Input x+6 17: Input x+7 18: 24 V_{SEN x+4} 19: 24 V_{SEN x+5} 20: 24 V_{SEN x+6} 21: 24 V_{SEN x+7} 22: 0 V_{SEN x+2 and 3} 23: 0 V_{SEN x+2 and 3} 24: 0 V_{SEN x+2 and 3} 25: FE Socket: FE</p>
CPX-AB-4-HAR-4POL				
	<p>X1.1: 24 V_{SEN} X1.2: Input x+1 X1.3: 0 V_{SEN} X1.4: Input x</p> <p>X2.1: 24 V_{SEN} X2.2: n.c. X2.3: 0 V_{SEN} X2.4: Input x+1</p>	<p>X3.1: 24 V_{SEN} X3.2: Input x+3 X3.3: 0 V_{SEN} X3.4: Input x+2</p> <p>X4.1: 24 V_{SEN} X4.2: n.c. X4.3: 0 V_{SEN} X4.4: Input x+3</p>	<p>X1.1: 24 V_{SEN x} X1.2: Input x+1 X1.3: 0 V_{SEN x} X1.4: Input x</p> <p>X2.1: 24 V_{SEN x+2} X2.2: Input x+3 X2.3: 0 V_{SEN x+2} X2.4: Input x+2</p>	<p>X3.1: 24 V_{SEN x+4} X3.2: Input x+5 X3.3: 0 V_{SEN x+4} X3.4: Input x+4</p> <p>X4.1: 24 V_{SEN x+6} X4.2: Input x+7 X4.3: 0 V_{SEN x+6} X4.4: Input x+6</p>

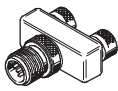
Terminal CPX

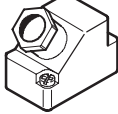
Accessories – Input module, digital

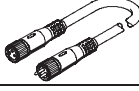
FESTO

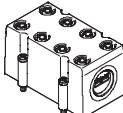
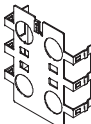
Ordering data				
Designation			Type	Part No.
Plug				
	Push-in T-connector	2x socket M12, 5-pin 1x plug M12, 4-pin	NEDU-M12D5-M12T4	541596
		2x socket M8, 3-pin 1x plug M12, 4-pin	NEDU-M8D3-M12T4	541597
	Plug	M8, 3-pin, solderable	SEA-GS-M8	18696
		M8, 3-pin, screw-in	SEA-3GS-M8-S	192009
		M12, 4-pin, PG7	SEA-GS-7	18666
		M12, PG7, 4-pin for cable Ø 2.5 mm	SEA-4GS-7-2,5	192008
		M12, 4-pin, PG9	SEA-GS-9	18778
		M12, 4-pin for 2 cables	SEA-GS-11-DUO	18779
		M12 for 2 cables, 5-pin	SEA-5GS-11-DUO	192010
	HARAX plug, 4-pin	M12, 5-pin	SEA-M12-5GS-PG7	175487
			SEA-GS-HAR-4POL	525928
	Sub-D plug, 25-pin		SD-SUB-D-ST25	527522
Connecting cable				
	Connecting cable M8-M8	0.5 m	KM8-M8-GSGD-0,5	175488
		1.0 m	KM8-M8-GSGD-1	175489
		2.5 m	KM8-M8-GSGD-2,5	165610
		5.0 m	KM8-M8-GSGD-5	165611
	Connecting cable M12-M12	2.5 m	KM12-M12-GSGD-2,5	18684
		5.0 m	KM12-M12-GSGD-5	18686
1.0 m		KM12-M12-GSWD-1-4	185499	
	Modular system for connecting cables		NEBU-... → Internet: nebu	-
	DUO cable M12	2x straight socket	KM12-DUO-M8-GDGD	18685
		2x straight/angled socket	KM12-DUO-M8-GDWD	18688
		2x angled socket	KM12-DUO-M8-WDWD	18687
Cover				
	Cover for CPX-AB-8-KL-4POL (IP65/67) – 8 cable through-feeds M9 – 1 cable through-feed for multi-pin plug		AK-8KL	538219
	Fittings kit		VG-K-M9	538220
Screening plate				
	Screening plate for M12 connections		CPX-AB-S-4-M12	526184

Terminal CPX

Accessories – Input module, digital

FESTO

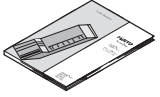
Ordering data				
Designation		Type	Part No.	
User documentation				
	User documentation	German	P.BE-CPX-EA-DE	526439
		English	P.BE-CPX-EA-EN	526440
		Spanish	P.BE-CPX-EA-ES	526441
		French	P.BE-CPX-EA-FR	526442
		Italian	P.BE-CPX-EA-IT	526443
		Swedish	P.BE-CPX-EA-SV	526444

Terminal CPX

Technical data – Input module, digital, 16 inputs

Function

Digital input modules enable the connection of two-wire and three-wire sensors (proximity sensors, inductive or capacitive sensors, etc).

Depending on the connection block selected, the module supports various connection concepts with different numbers of sockets (single or double allocation).

Application

- Input modules for 24 V DC sensor voltage supply
- PNP logic
- Module features can be parameterised
- The input module receives the voltage supply for the electronics and the sensors from the interlinking block
- Module protection and diagnostics through integrated electronic fuse protection



General technical data			CPX-16DE	CPX-M-16DE-D
Type			543815	550202
Part No.				
No. of inputs			16	16
Max. power supply	per module	[A]	1.8	1.8
	per channel	[A]	0.5	0.5 (per channel pair)
Fuse protection			Internal electronic fuse protection for each module	Internal electronic fuse protection for each channel pair
Intrinsic current consumption	[mA]		Typ. 15	Typ. 34
Supply voltage of sensors	[V DC]		24 ±25%	24 ±25%
Galvanic isolation	Channel – Channel		No	No
	Channel – Internal bus		No	No
Switching level	Signal 0	[V DC]	≤ 5	≤ 5
	Signal 1	[V DC]	≥ 11	≥ 11
Switch-on debounce time	[ms]		3 (0.1 ms, 10, 20 parameterisable)	3 (0.1 ms, 10, 20 parameterisable)
Input characteristic curve			IEC 1131-2	IEC 1131-2
Switching logic			Positive logic (PNP)	Positive logic (PNP)
LED displays	Group diagnostics		1	1
	Channel diagnostics		–	16
	Channel status		16	16
Diagnostics			Short circuit/overload, sensor supply	Short circuit/overload per channel
Parameterisation			<ul style="list-style-type: none"> • Module monitoring • Behaviour after short circuit • Switch-on debounce time • Signal stretching time 	<ul style="list-style-type: none"> • Module monitoring • Behaviour after short circuit • Switch-on debounce time • Signal stretching time
Protection class to EN 60529			Depending on connection block	Depending on connection block
Temperature range	Operation	[°C]	–5 ... +50	–5 ... +50
	Storage/transport	[°C]	–20 ... +70	–20 ... +70
Materials			Polymer	Polymer
Grid dimension	[mm]		50	50
Dimensions (including interlinking block and connection block)	[mm]		50 x 107 x 50	50 x 107 x 50
W x L x H				
Weight	[g]		38	38

Terminal CPX

Technical data – Input module, digital, 16 inputs

Connection and display components

CPX-16DE

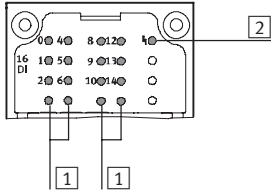

- 1 Status LEDs (green)
Allocation to inputs
→ Pin allocation for module
- 2 Error LED (red, module error)

Connection block/digital input module combinations

Connection blocks	Part No.	Digital input modules	
		CPX-16DE	CPX-M-16DE-D
CPX-AB-8-M8X2-4POL	541256	■	–
CPX-AB-8-KL-4POL	195708	■	–
CPX-AB-1-SUB-BU-25POL	525676	■	–
CPX-M-8-M12x2-5POL	549335	–	■
CPX-AB-8-M8x2-4P-M3	556166	■	–

Pin allocation

Connection block inputs	CPX-16DE
CPX-AB-8-M8x2-4POL	
	<p>X1.1: 24 V_{SEN} X1.2: Input x+1 X1.3: 0 V_{SEN} X1.4: Input x</p> <p>X2.1: 24 V_{SEN} X2.2: Input x+3 X2.3: 0 V_{SEN} X2.4: Input x+2</p> <p>X3.1: 24 V_{SEN} X3.2: Input x+5 X3.3: 0 V_{SEN} X3.4: Input x+4</p> <p>X4.1: 24 V_{SEN} X4.2: Input x+7 X4.3: 0 V_{SEN} X4.4: Input x+6</p> <p>X5.1: 24 V_{SEN} X5.2: Input x+9 X5.3: 0 V_{SEN} X5.4: Input x+8</p> <p>X6.1: 24 V_{SEN} X6.2: Input x+11 X6.3: 0 V_{SEN} X6.4: Input x+10</p> <p>X7.1: 24 V_{SEN} X7.2: Input x+13 X7.3: 0 V_{SEN} X7.4: Input x+12</p> <p>X8.1: 24 V_{SEN} X8.2: Input x+15 X8.3: 0 V_{SEN} X8.4: Input x+14</p>

Terminal CPX

Technical data – Input module, digital, 16 inputs

Pin allocation		CPX-M-16DE-D	
Connection block inputs		CPX-M-16DE-D	
CPX-M-8-M12x2-5POL			
	<p>X 1</p> <p>X 2</p> <p>X 3</p> <p>X 4</p> <p>X 5</p> <p>X 6</p> <p>X 7</p> <p>X 8</p>	<p>X1.1: 24 V_{Sx}</p> <p>X1.2: Input x+1</p> <p>X1.3: 0 V_{Sx}</p> <p>X1.4: Input x</p> <p>X1.5: FE</p>	<p>X5.1: 24 V_{Sx+8}</p> <p>X5.2: Input x+9</p> <p>X5.3: 0 V_{Sx+8}</p> <p>X5.4: Input x+8</p> <p>X5.5: FE</p>
		<p>X2.1: 24 V_{Sx+2}</p> <p>X2.2: Input x+3</p> <p>X2.3: 0 V_{Sx+2}</p> <p>X2.4: Input x+2</p> <p>X2.5: FE</p>	<p>X6.1: 24 V_{Sx+10}</p> <p>X6.2: Input x+11</p> <p>X6.3: 0 V_{Sx+10}</p> <p>X6.4: Input x+10</p> <p>X6.5: FE</p>
		<p>X3.1: 24 V_{Sx+4}</p> <p>X3.2: Input x+5</p> <p>X3.3: 0 V_{Sx+4}</p> <p>X3.4: Input x+4</p> <p>X3.5: FE</p>	<p>X7.1: 24 V_{Sx+12}</p> <p>X7.2: Input x+13</p> <p>X7.3: 0 V_{Sx+12}</p> <p>X7.4: Input x+12</p> <p>X7.5: FE</p>
		<p>X4.1: 24 V_{Sx+6}</p> <p>X4.2: Input x+7</p> <p>X4.3: 0 V_{Sx+6}</p> <p>X4.4: Input x+6</p> <p>X4.5: FE</p>	<p>X8.1: 24 V_{Sx+14}</p> <p>X8.2: Input x+15</p> <p>X8.3: 0 V_{Sx+14}</p> <p>X8.4: Input x+14</p> <p>X8.5: FE</p>

Terminal CPX



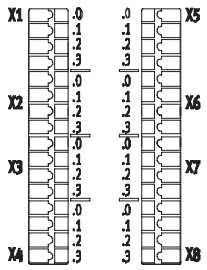
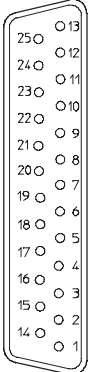



Technical data – Input module, digital, 16 inputs

Pin allocation		
Connection block inputs	CPX-16DE	
CPX-AB-8-KL-4POL		
	<p>X1.0: Input x+8 X1.1: 24 V_{SEN} X1.2: Input x X1.3: FE (earth)</p> <p>X2.0: Input x+9 X2.1: 24 V_{SEN} X2.2: Input x+1 X2.3: FE (earth)</p> <p>X3.0: Input x+10 X3.1: 24 V_{SEN} X3.2: Input x+2 X3.3: FE (earth)</p> <p>X4.0: Input x+11 X4.1: 24 V_{SEN} X4.2: Input x+3 X4.3: FE (earth)</p>	<p>X5.0: Input x+12 X5.1: 0 V_{SEN} X5.2: Input x+4 X5.3: FE (earth)</p> <p>X6.0: Input x+13 X6.1: 0 V_{SEN} X6.2: Input x+5 X6.3: FE (earth)</p> <p>X7.0: Input x+14 X7.1: 0 V_{SEN} X7.2: Input x+6 X7.3: FE (earth)</p> <p>X8.0: Input x+15 X8.1: 0 V_{SEN} X8.2: Input x+7 X8.3: FE (earth)</p>
CPX-AB-1-SUB-BU-25POL		
	<p>1: Input x 2: Input x+1 3: Input x+2 4: Input x+3 5: Input x+9 6: 24 V_{SEN} 7: Input x+11 8: 24 V_{SEN} 9: Input x+8 10: Input x+10 11: 24 V_{SEN} 12: 24 V_{SEN} 13: FE (earth)</p>	<p>14: Input x+4 15: Input x+5 16: Input x+6 17: Input x+7 18: Input x+12 19: Input x+13 20: Input x+14 21: Input x+15 22: 0 V_{SEN} 23: 0 V_{SEN} 24: 0 V_{SEN} 25: FE (earth) Housing: FE</p>

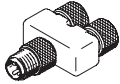
Terminal CPX

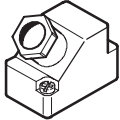
Accessories – Input module, digital, 16 inputs

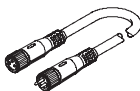
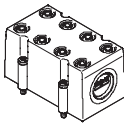
FESTO

Ordering data				
Designation			Type	Part No.
Plug				
	Push-in T-connector	2x socket M8, 3-pin 1x plug M8, 4-pin	NEDU-M8D3-M8T4	544391
	M8 plug, 3-pin	Solderable	SEA-GS-M8	18696
		Screw-in	SEA-3GS-M8-S	192009
	Sub-D plug, 25-pin		SD-SUB-D-ST25	527522
Connecting cable				
	Connecting cable M8-M8	0.5 m	KM8-M8-GSGD-0,5	175488
		1.0 m	KM8-M8-GSGD-1	175489
		2.5 m	KM8-M8-GSGD-2,5	165610
		5.0 m	KM8-M8-GSGD-5	165611
	Modular system for connecting cables		NEBU-... → Internet: nebu	–
Cover				
	Cover for CPX-AB-8-KL-4POL (IP65/67) – 8 cable through-feeds M9 – 1 cable through-feed for multi-pin plug		AK-8KL	538219
	Fittings kit		VG-K-M9	538220
User documentation				
	User documentation	German	P.BE-CPX-EA-DE	526439
		English	P.BE-CPX-EA-EN	526440
		Spanish	P.BE-CPX-EA-ES	526441
		French	P.BE-CPX-EA-FR	526442
		Italian	P.BE-CPX-EA-IT	526443
		Swedish	P.BE-CPX-EA-SV	526444

Terminal CPX

Technical data – Output module, digital

Function

Digital outputs control actuators such as individual valves, hydraulic valves, heating controllers and many more. Separate circuits are created using an additional power supply. Parallel connection of the outputs of a module enables consuming devices to be controlled with up to 4 A.

Application

- Output module for 24 V DC supply voltage
- PNP logic
- Module features can be parameterised
- The output module receives the voltage supply for the electronics and the outputs from the interlinking block
- Module protection and diagnostics through integrated electronic fuse protection in each channel



General technical data				
Type		CPX-4DA	CPX-8DA	CPX-8DA-H
Part No.		195754	541482	550204
No. of outputs		4	8	8
Max. power supply	per module [A]	4		8.4
	per channel [A]	1 (24 W lamp load, 4 channels can be connected in parallel)	0.5 (12 W lamp load, 8 channels can be connected in parallel)	2.1 (50 W lamp load), per channel pair
Protection (short circuit)		Internal electronic fuse protection for each channel		
Module current consumption (voltage supply for electronics)	[mA]	Typ. 16		Typ. 34
Operating voltage	Nominal value [V DC]	24		
	Permissible range [V DC]	18 ... 30		
Galvanic isolation	Channel – Channel	No		
	Channel – Internal bus	Yes, using an intermediate supply		
Output characteristic curve		To IEC 1131-2		
Switching logic		Positive logic (PNP)		
LED displays	Group diagnostics	1	1	1
	Channel diagnostics	4	8	8
	Channel status	4	8	8
Diagnostics		<ul style="list-style-type: none"> • Short circuit/overload, per channel • Load voltage of outputs 		
Parameterisation		<ul style="list-style-type: none"> • Module monitoring • Behaviour after short circuit • Fail-safe channel x • Forcing channel x • Idle mode channel x 		
Protection class to EN 60529		Depending on connection block		
Temperature range	Operation [°C]	–5 ... +50		
	Storage/transport [°C]	–20 ... +70		
Materials		Reinforced polyamide, polycarbonate		
Grid dimension	[mm]	50		
Dimensions (including interlinking block and connection block)	[mm]	50 x 107 x 50		
W x L x H				
Weight	[g]	38		

Terminal CPX

Technical data – Output module, digital

Connection and display components

CPX-4DA

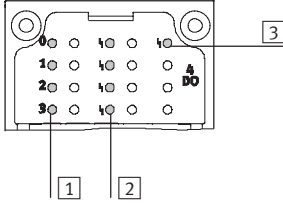

CPX-8DA

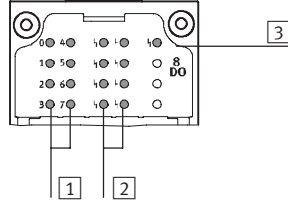

- 1 Status LEDs (yellow)
Allocation to outputs
→ Pin allocation for module
- 2 Channel-oriented error LEDs (red)
- 3 Error LED (red, module error)

Connection block/digital output module combinations

Connection blocks	Part No.	Digital output module		
		CPX-4DA	CPX-8DA	CPX-8DA-H
CPX-AB-8-M8-3POL	195706	■	■	–
CPX-AB-8-M8X2-4POL	541256	■	■	■
CPX-AB-4-M12X2-5POL	195704	■	■	–
CPX-AB-4-M12X2-5POL-R	541254	■	■	■
CPX-AB-8-KL-4POL	195708	■	■	■
CPX-AB-1-SUB-BU-25POL	525676	■	■	■
CPX-AB-4-HAR-4POL	525636	■	■	–
CPX-AB-8-M8x2-4P-M3	556166	■	■	■
CPX-AB-4-M12x2-5P-R-M3	546997	■	■	■
CPX-M-4-M12x2-5POL	549367	■	■	–

Pin allocation

Connection block outputs	CPX-4DA	CPX-8DA
CPX-AB-8-M8-3POL		
	X1.1: n.c. X1.3: 0 V _{OUT} X1.4: Output x X2.1: n.c. X2.3: 0 V _{OUT} X2.4: Output x+1 X3.1: n.c. X3.3: 0 V _{OUT} X3.4: Output x+1 X4.1: n.c. X4.3: 0 V _{OUT} X4.4: n.c.	X5.1: n.c. X5.3: 0 V _{OUT} X5.4: Output x+2 X6.1: n.c. X6.3: 0 V _{OUT} X6.4: Output x+3 X7.1: n.c. X7.3: 0 V _{OUT} X7.4: Output x+3 X8.1: n.c. X8.3: 0 V _{OUT} X8.4: n.c.
		X1.1: n.c. X1.3: 0 V _{OUT} X1.4: Output x X2.1: n.c. X2.3: 0 V _{OUT} X2.4: Output x+1 X3.1: n.c. X3.3: 0 V _{OUT} X3.4: Output x+2 X4.1: n.c. X4.3: 0 V _{OUT} X4.4: Output x+3
		X5.1: n.c. X5.3: 0 V _{OUT} X5.4: Output x+4 X6.1: n.c. X6.3: 0 V _{OUT} X6.4: Output x+5 X7.1: n.c. X7.3: 0 V _{OUT} X7.4: Output x+6 X8.1: n.c. X8.3: 0 V _{OUT} X8.4: Output x+7

Terminal CPX

Technical data – Output module, digital

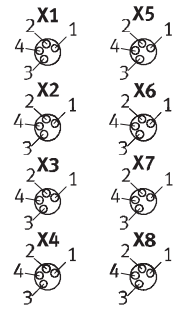
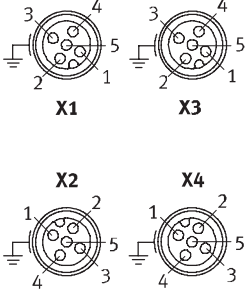
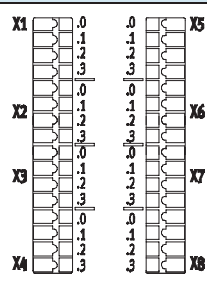
Pin allocation					
Connection block outputs		CPX-4DA	CPX-8DA and CPX-8DA-H		
CPX-AB-8-M8X2-4POL and CPX-AB-8-M8x2-4P-M3					
	X1.1: 0 V _{OUT} X1.2: Output x+1 X1.3: 0 V _{OUT} X1.4: Output x X2.1: 0 V _{OUT} X2.2: n.c. X2.3: 0 V _{OUT} X2.4: Output x+1 X3.1: 0 V _{OUT} X3.2: Output x+3 X3.3: 0 V _{OUT} X3.4: Output x+2 X4.1: 0 V _{OUT} X4.2: n.c. X4.3: 0 V _{OUT} X4.4: Output x+3	X5.1: 0 V _{OUT} X5.2: n.c. X5.3: 0 V _{OUT} X5.4: n.c. X6.1: 0 V _{OUT} X6.2: n.c. X6.3: 0 V _{OUT} X6.4: n.c. X7.1: 0 V _{OUT} X7.2: n.c. X7.3: 0 V _{OUT} X7.4: n.c. X8.1: 0 V _{OUT} x+1 X8.2: n.c. X8.3: 0 V _{OUT} x+3 X8.4: n.c.	X1.1: 0 V _{OUT} X1.2: Output x+1 X1.3: 0 V _{OUT} X1.4: Output x X2.1: 0 V _{OUT} X2.2: Output x+3 X2.3: 0 V _{OUT} X2.4: Output x+2 X3.1: 0 V _{OUT} X3.2: Output x+5 X3.3: 0 V _{OUT} X3.4: Output x+4 X4.1: 0 V _{OUT} X4.2: Output x+7 X4.3: 0 V _{OUT} X4.4: Output x+6	X5.1: 0 V _{OUT} X5.2: n.c. X5.3: 0 V _{OUT} X5.4: n.c. X6.1: 0 V _{OUT} X6.2: n.c. X6.3: 0 V _{OUT} X6.4: n.c. X7.1: 0 V _{OUT} X7.2: n.c. X7.3: 0 V _{OUT} X7.4: n.c. X8.1: 0 V _{OUT} X8.2: n.c. X8.3: 0 V _{OUT} X8.4: n.c.	
CPX-AB-4-M12X2-5POL¹⁾, CPX-AB-4-M12X2-5POL-R²⁾ and CPX-AB-4-M12x2-5P-R-M3²⁾					
	X1.1: n.c. X1.2: Output x+1 X1.3: 0 V _{OUT} X1.4: Output x X1.5: FE X2.1: n.c. X2.2: n.c. X2.3: 0 V _{OUT} X2.4: Output x+1 X2.5: FE	X3.1: n.c. X3.2: Output x+3 X3.3: 0 V _{OUT} X3.4: Output x+2 X3.5: FE X4.1: n.c. X4.2: n.c. X4.3: 0 V _{OUT} X4.4: Output x+3 X4.5: FE	X1.1: n.c. X1.2: Output x+1 X1.3: 0 V _{OUT} X1.4: Output x X1.5: FE X2.1: n.c. X2.2: Output x+3 X2.3: 0 V _{OUT} X2.4: Output x+2 X2.5: FE	X3.1: n.c. X3.2: Output x+5 X3.3: 0 V _{OUT} X3.4: Output x+4 X3.5: FE X4.1: n.c. X4.2: Output x+7 X4.3: 0 V _{OUT} X4.4: Output x+6 X4.5: FE	
CPX-AB-8-KL-4POL					
	X1.0: n.c. X1.1: 0 V _{OUT} X1.2: Output x X1.3: FE X2.0: n.c. X2.1: 0 V _{OUT} X2.2: Output x+1 X2.3: FE X3.0: n.c. X3.1: 0 V _{OUT} X3.2: Output x+1 X3.3: FE X4.0: n.c. X4.1: 0 V _{OUT} X4.2: n.c. X4.3: FE	X5.0: n.c. X5.1: 0 V _{OUT} X5.2: Output x+2 X5.3: FE X6.0: n.c. X6.1: 0 V _{OUT} X6.2: Output x+3 X6.3: FE X7.0: n.c. X7.1: 0 V _{OUT} X7.2: Output x+3 X7.3: FE X8.0: n.c. X8.1: 0 V _{OUT} X8.2: n.c. X8.3: FE	X1.0: n.c. X1.1: 0 V _{OUT} X1.2: Output x X1.3: FE X2.0: n.c. X2.1: 0 V _{OUT} X2.2: Output x+1 X2.3: FE X3.0: n.c. X3.1: 0 V _{OUT} X3.2: Output x+2 X3.3: FE X4.0: n.c. X4.1: 0 V _{OUT} X4.2: Output x+3 X4.3: FE	X5.0: n.c. X5.1: 0 V _{OUT} X5.2: Output x+4 X5.3: FE X6.0: n.c. X6.1: 0 V _{OUT} X6.2: Output x+5 X6.3: FE X7.0: n.c. X7.1: 0 V _{OUT} X7.2: Output x+6 X7.3: FE X8.0: n.c. X8.1: 0 V _{OUT} X8.2: Output x+7 X8.3: FE	

1) Not suitable for CPX-8DA-H.

2) Speedcon quick lock, metal thread with additional screening

Terminal CPX



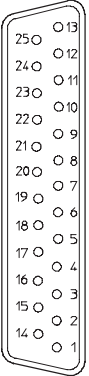
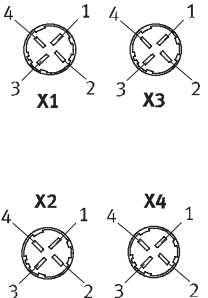

Technical data – Output module, digital

Pin allocation				
Connection block outputs	CPX-4DA	CPX-8DA and CPX-8DA-H		
CPX-AB-1-SUB-BU-25POL				
	1: Output x 2: Output x+1 3: Output x+1 4: n.c. 5: n.c. 6: 0 V _{OUT} 7: n.c. 8: 0 V _{OUT} 9: n.c. 10: n.c. 11: 0 V _{OUT} 12: 0 V _{OUT} 13: FE	14: Output x+2 15: Output x+3 16: Output x+3 17: n.c. 18: n.c. 19: n.c. 20: n.c. 21: n.c. 22: 0 V _{OUT} 23: 0 V _{OUT} 24: 0 V _{OUT} 25: FE Socket: FE	1: Output x 2: Output x+1 3: Output x+2 4: Output x+3 5: n.c. 6: 0 V _{OUT} 7: n.c. 8: 0 V _{OUT} 9: n.c. 10: n.c. 11: 0 V _{OUT} 12: 0 V _{OUT} 13: FE	14: Output x+4 15: Output x+5 16: Output x+6 17: Output x+7 18: n.c. 19: n.c. 20: n.c. 21: n.c. 22: 0 V _{OUT} 23: 0 V _{OUT} 24: 0 V _{OUT} 25: FE Socket: FE
CPX-AB-4-HAR-4POL¹⁾				
	X1.1: n.c. X1.2: Output x+1 X1.3: 0 V _{OUT} X1.4: Output x X2.1: n.c. X2.2: n.c. X2.3: 0 V _{OUT} X2.4: Output x+1	X3.1: n.c. X3.2: Output x+3 X3.3: 0 V _{OUT} X3.4: Output x+2 X4.1: n.c. X4.2: n.c. X4.3: 0 V _{OUT} X4.4: Output x+3	X1.1: n.c. X1.2: Output x+1 X1.3: 0 V _{OUT} X1.4: Output x X2.1: n.c. X2.2: Output x+3 X2.3: 0 V _{OUT} X2.4: Output x+2	X3.1: n.c. X3.2: Output x+5 X3.3: 0 V _{OUT} X3.4: Output x+4 X4.1: n.c. X4.2: Output x+7 X4.3: 0 V _{OUT} X4.4: Output x+6

1) Not suitable for CPX-8DA-H.

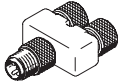
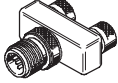
Terminal CPX

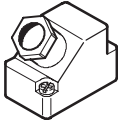
Accessories – Output module, digital

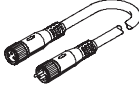
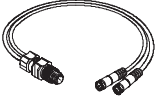
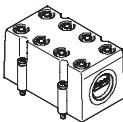
Ordering data				
Designation			Type	Part No.
Plug				
	Push-in T-connector	2x socket M8, 3-pin 1x plug M8, 4-pin	NEDU-M8D3-M8T4	544391
	Push-in T-connector	2x socket M12, 5-pin 1x plug M12, 4-pin	NEDU-M12D5-M12T4	541596
		2x socket M8, 3-pin 1x plug M12, 4-pin	NEDU-M8D3-M12T4	541597
	Plug	M8, 3-pin, solderable	SEA-GS-M8	18696
		M8, 3-pin, screw-in	SEA-3GS-M8-S	192009
		M12, PG7	SEA-GS-7	18666
		M12, PG7, 4-pin for cable Ø 2.5 mm	SEA-4GS-7-2,5	192008
		M12, PG9	SEA-GS-9	18778
		M12 for 2 cables	SEA-GS-11-DUO	18779
		M12 for 2 cables, 5-pin	SEA-5GS-11-DUO	192010
		M12, 5-pin	SEA-M12-5GS-PG7	175487
	HARAX plug, 4-pin		SEA-GS-HAR-4POL	525928
	Sub-D plug, 25-pin		SD-SUB-D-ST25	527522
Connecting cable				
	Connecting cable M8-M8	0.5 m	KM8-M8-GSGD-0,5	175488
		1.0 m	KM8-M8-GSGD-1	175489
		2.5 m	KM8-M8-GSGD-2,5	165610
		5.0 m	KM8-M8-GSGD-5	165611
	Connecting cable M12-M12	2.5 m	KM12-M12-GSGD-2,5	18684
		5.0 m	KM12-M12-GSGD-5	18686
1.0 m		KM12-M12-GSWD-1-4	185499	
	Modular system for connecting cables		NEBU-... → Internet: nebu	–
	DUO cable M12	2x straight socket	KM12-DUO-M8-GDGD	18685
		2x straight/angled socket	KM12-DUO-M8-GDWD	18688
		2x angled socket	KM12-DUO-M8-WDWD	18687
Cover				
	Cover for CPX-AB-8-KL-4POL (IP65/67) – 8 cable through-feeds M9 – 1 cable through-feed for multi-pin plug		AK-8KL	538219
	Fittings kit		VG-K-M9	538220

Terminal CPX

Accessories – Output module, digital

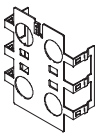
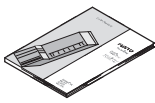
Ordering data			
Designation		Type	Part No.
Screening plate			
	Screening plate for M12 connections	CPX-AB-S-4-M12	526184
User documentation			
	User documentation	German	P.BE-CPX-EA-DE
		English	P.BE-CPX-EA-EN
		Spanish	P.BE-CPX-EA-ES
		French	P.BE-CPX-EA-FR
		Italian	P.BE-CPX-EA-IT
		Swedish	P.BE-CPX-EA-SV

Terminal CPX

Technical data – Input/output module, digital

Application

- Digital multi I/O module for 24 V DC supply voltage
- Supports connection blocks with Sub-D, terminal connection and M12 connection (8-pin)
- Module features can be parameterised
- The inputs receive the voltage supply for the electronics and the sensors from the interlinking block
- The outputs receive the voltage supply for the electronics and outputs from the interlinking block
- Module protection and diagnostics through integrated electronic fuse protection for the sensor power supply and integrated electronic fuse protection in each output channel



Function

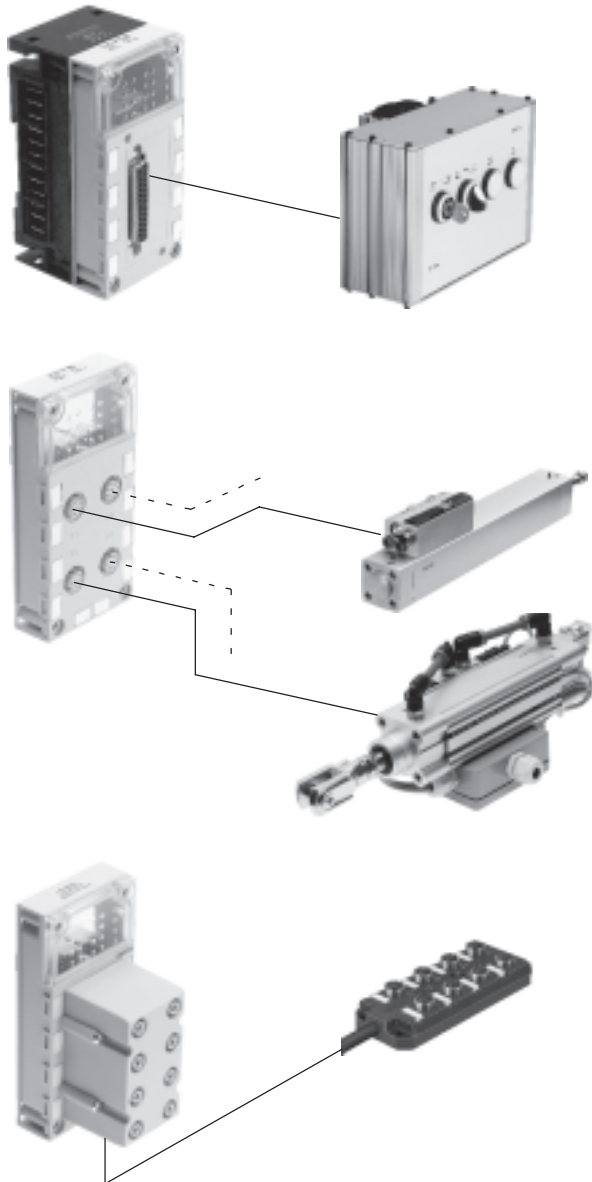

The multi I/O module controls devices with a high number of inputs and outputs per connection point. Because the module supports Sub-D connection blocks, consoles with pushbuttons and lamps can be connected to the CPX terminal using a minimal amount of installation space.

Up to 8 inputs and outputs can be connected to a connection point with IP65 protection.

Support for the M12 connection block (8-pin) means that up to 4 cylinder-valve combinations with integrated sensors can be connected. Each cylinder-valve combination is supported by 2 inputs and 2 outputs per socket. It is therefore possible to control max. 2 solenoid coils and operate 2 sensors with a pre-assembled cable.

Two inputs on two sockets are bridged to provide support for the diagnostic module of the cylinder-valve combination. This effectively means that there are 3 inputs and 2 outputs available on 2 sockets.

As an alternative to the Sub-D and M12 connection block (8-pin) for installation with higher protection class IP65, the terminal connection block produces an identical result for installation with IP20 protection – or with IP65/67 protection with additional cover.

Subordinate I/O modules with multi-pin plug connection (Sub-D plug or multi-pin cable for self-assembly) support the cost-effective and space-saving integration of critical installation areas such as chain link trunking or upstream functions.

Terminal CPX

Technical data – Input/output module, digital

FESTO

General technical data			
Type	CPX-8DE-8DA		
Part No.	526257		
No. of	Inputs		8
	Outputs		8
Max. power supply per module	Sensor supply	[A]	0.7
	Outputs	[A]	4
Max. power supply per channel	Sensor supply	[A]	0.5
	Outputs	[A]	0.5
Max. power supply per channel		[A]	0.5 (12 W lamp load, channels A0 ... A03 can be switched parallel to A4 ... A7)
Fuse protection	Sensor supply		Internal electronic fuse protection for sensor supply
	Outputs		Internal electronic fuse protection for each channel
Internal electronics current consumption	Inputs	[mA]	Typ. 22
	Outputs	[mA]	Typ. 34
Operating voltage	Nominal value	[V DC]	24
	Permissible range	[V DC]	18 ... 30
Galvanic isolation, inputs	Channel – Channel		No
	Channel – Internal bus		No
Galvanic isolation, outputs	Channel – Channel		No
	Channel – Internal bus		Yes, using an intermediate supply
Characteristic curve	Inputs		IEC 1131-2
	Outputs		To IEC 1131-2
Switching level, inputs	Signal 0	[V DC]	≤ 5
	Signal 1	[V DC]	≥ 11
Switch-on debounce time		[ms]	3 (0.1, 10, 20 parameterisable)
Switching logic			Positive logic (PNP)
LED displays	Group diagnostics		1
	Channel diagnostics		–
	Channel status		16
Diagnostics	Inputs		<ul style="list-style-type: none"> • Short circuit/overload, sensor supply
	Outputs		<ul style="list-style-type: none"> • Short circuit/overload, output channel x • Undervoltage outputs
Parameterisation	Inputs		<ul style="list-style-type: none"> • Module monitoring • Behaviour after short circuit, sensor supply • Switch-on debounce time • Signal stretching time, inputs
	Outputs		<ul style="list-style-type: none"> • Behaviour after short circuit • Fail-safe channel x • Forcing channel x • Idle mode channel x
Protection class to EN 60529			Depending on connection block
Temperature range	Operation	[°C]	–5 ... +50
	Storage/transport	[°C]	–20 ... +70
Materials			Reinforced polyamide, polycarbonate
Grid dimension		[mm]	50
Dimensions (including interlinking block and connection block)		[mm]	50 x 107 x 50
W x L x H			
Weight		[g]	38

Terminal CPX

Technical data – Input/output module, digital

Connection and display components

CPX-8DE-8DA

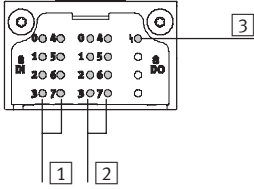

- 1 Status LEDs (green)
Allocation to inputs
→ Pin allocation for module
- 2 Status LEDs (yellow)
Allocation to outputs
→ Pin allocation for module
- 3 Error LED (red)
(module error)

Connection block/digital input/output module combinations

Connection blocks	Part No.	Digital I/O module
		CPX-8DE-8DA
CPX-AB-4-M12-8POL	526178	■
CPX-AB-8-KL-4POL	195708	■
CPX-AB-1-SUB-BU-25POL	525676	■
CPX-AB-4-M12-8P-M3	556168	■

Pin allocation

Connection block inputs/outputs CPX-8DE-8DA

CPX-AB-4-M12-8POL and CPX-AB-4-M12-8P-M3

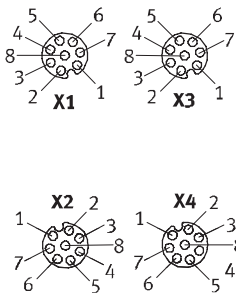

X1.1: 24 V _{SEN}	X3.1: 24 V _{SEN}
X1.2: Input x	X3.2: Input x+4
X1.3: Input x+1	X3.3: Input x+5
X1.4: 0 V _{SEN}	X3.4: 0 V _{SEN}
X1.5: Output x	X3.5: Output x+4
X1.6: Output x+1	X3.6: Output x+5
X1.7: Input x+4	X3.7: n.c.
X1.8: 0 V _{OUT}	X3.8: 0 V _{OUT}
X2.1: 24 V _{SEN}	X4.1: 24 V _{SEN}
X2.2: Input x+2	X4.2: Input x+6
X2.3: Input x+3	X4.3: Input x+7
X2.4: 0 V _{SEN}	X4.4: 0 V _{SEN}
X2.5: Output x+2	X4.5: Output x+6
X2.6: Output x+3	X4.6: Output x+7
X2.7: Input x+6	X4.7: n.c.
X2.8: 0 V _{OUT}	X4.8: 0 V _{OUT}

Terminal CPX



Technical data – Input/output module, digital

Pin allocation																																	
Connection block inputs/outputs	CPX-8DE-8DA																																
CPX-AB-8-KL-4POL																																	
	<table border="0"> <tr> <td>X1.0: 24 V_{SEN}</td> <td>X5.0: Output x+4</td> </tr> <tr> <td>X1.1: 0 V_{SEN}</td> <td>X5.1: 0 V_{OUT}</td> </tr> <tr> <td>X1.2: Input x</td> <td>X5.2: Output x</td> </tr> <tr> <td>X1.3: FE</td> <td>X5.3: FE</td> </tr> <tr> <td>X2.0: Input x+4</td> <td>X6.0: Output x+5</td> </tr> <tr> <td>X2.1: Input x+5</td> <td>X6.1: 0 V_{OUT}</td> </tr> <tr> <td>X2.2: Input x+1</td> <td>X6.2: Output x+1</td> </tr> <tr> <td>X2.3: FE</td> <td>X6.3: FE</td> </tr> <tr> <td>X3.0: 24 V_{SEN}</td> <td>X7.0: Output x+6</td> </tr> <tr> <td>X3.1: 0 V_{SEN}</td> <td>X7.1: 0 V_{OUT}</td> </tr> <tr> <td>X3.2: Input x+2</td> <td>X7.2: Output x+2</td> </tr> <tr> <td>X3.3: FE</td> <td>X7.3: FE</td> </tr> <tr> <td>X4.0: Input x+6</td> <td>X8.0: Output x+7</td> </tr> <tr> <td>X4.1: Input x+7</td> <td>X8.1: 0 V_{OUT}</td> </tr> <tr> <td>X4.2: Input x+3</td> <td>X8.2: Output x+3</td> </tr> <tr> <td>X4.3: FE</td> <td>X8.3: FE</td> </tr> </table>	X1.0: 24 V _{SEN}	X5.0: Output x+4	X1.1: 0 V _{SEN}	X5.1: 0 V _{OUT}	X1.2: Input x	X5.2: Output x	X1.3: FE	X5.3: FE	X2.0: Input x+4	X6.0: Output x+5	X2.1: Input x+5	X6.1: 0 V _{OUT}	X2.2: Input x+1	X6.2: Output x+1	X2.3: FE	X6.3: FE	X3.0: 24 V _{SEN}	X7.0: Output x+6	X3.1: 0 V _{SEN}	X7.1: 0 V _{OUT}	X3.2: Input x+2	X7.2: Output x+2	X3.3: FE	X7.3: FE	X4.0: Input x+6	X8.0: Output x+7	X4.1: Input x+7	X8.1: 0 V _{OUT}	X4.2: Input x+3	X8.2: Output x+3	X4.3: FE	X8.3: FE
X1.0: 24 V _{SEN}	X5.0: Output x+4																																
X1.1: 0 V _{SEN}	X5.1: 0 V _{OUT}																																
X1.2: Input x	X5.2: Output x																																
X1.3: FE	X5.3: FE																																
X2.0: Input x+4	X6.0: Output x+5																																
X2.1: Input x+5	X6.1: 0 V _{OUT}																																
X2.2: Input x+1	X6.2: Output x+1																																
X2.3: FE	X6.3: FE																																
X3.0: 24 V _{SEN}	X7.0: Output x+6																																
X3.1: 0 V _{SEN}	X7.1: 0 V _{OUT}																																
X3.2: Input x+2	X7.2: Output x+2																																
X3.3: FE	X7.3: FE																																
X4.0: Input x+6	X8.0: Output x+7																																
X4.1: Input x+7	X8.1: 0 V _{OUT}																																
X4.2: Input x+3	X8.2: Output x+3																																
X4.3: FE	X8.3: FE																																
CPX-AB-1-SUB-BU-25POL																																	
	<table border="0"> <tr> <td>1: Input x</td> <td>14: Output x</td> </tr> <tr> <td>2: Input x+1</td> <td>15: Output x+1</td> </tr> <tr> <td>3: Input x+2</td> <td>16: Output x+2</td> </tr> <tr> <td>4: Input x+3</td> <td>17: Output x+3</td> </tr> <tr> <td>5: Input x+4</td> <td>18: Output x+4</td> </tr> <tr> <td>6: Input x+5</td> <td>19: Output x+5</td> </tr> <tr> <td>7: Input x+6</td> <td>20: Output x+6</td> </tr> <tr> <td>8: Input x+7</td> <td>21: Output x+7</td> </tr> <tr> <td>9: 24 V_{SEN}</td> <td>22: 0 V_{OUT}</td> </tr> <tr> <td>10: 24 V_{SEN}</td> <td>23: 0 V_{OUT}</td> </tr> <tr> <td>11: 0 V_{SEN}</td> <td>24: 0 V_{OUT}</td> </tr> <tr> <td>12: 0 V_{SEN}</td> <td>25: FE</td> </tr> <tr> <td>13: FE</td> <td>Socket: FE</td> </tr> </table>	1: Input x	14: Output x	2: Input x+1	15: Output x+1	3: Input x+2	16: Output x+2	4: Input x+3	17: Output x+3	5: Input x+4	18: Output x+4	6: Input x+5	19: Output x+5	7: Input x+6	20: Output x+6	8: Input x+7	21: Output x+7	9: 24 V _{SEN}	22: 0 V _{OUT}	10: 24 V _{SEN}	23: 0 V _{OUT}	11: 0 V _{SEN}	24: 0 V _{OUT}	12: 0 V _{SEN}	25: FE	13: FE	Socket: FE						
1: Input x	14: Output x																																
2: Input x+1	15: Output x+1																																
3: Input x+2	16: Output x+2																																
4: Input x+3	17: Output x+3																																
5: Input x+4	18: Output x+4																																
6: Input x+5	19: Output x+5																																
7: Input x+6	20: Output x+6																																
8: Input x+7	21: Output x+7																																
9: 24 V _{SEN}	22: 0 V _{OUT}																																
10: 24 V _{SEN}	23: 0 V _{OUT}																																
11: 0 V _{SEN}	24: 0 V _{OUT}																																
12: 0 V _{SEN}	25: FE																																
13: FE	Socket: FE																																

Terminal CPX

Accessories – Input/output module, digital

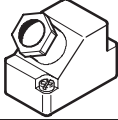
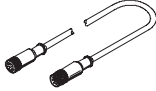
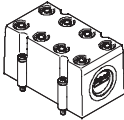
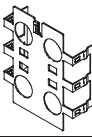
FESTO

Ordering data				
Designation		Type	Part No.	
Plug				
	Sub-D plug, 25-pin	SD-SUB-D-ST25	527522	
Connecting cable				
	Connecting cable M12	KM12-8GD8GS-2-PU	525617	
Cover				
	Cover for CPX-AB-8-KL-4POL (IP65/67) – 8 cable through-feeds M9 – 1 cable through-feed for multi-pin plug	AK-8KL	538219	
	Fittings kit	VG-K-M9	538220	
Screening plate				
	Screening plate for M12 connections	CPX-AB-S-4-M12	526184	
User documentation				
	User documentation	German	P.BE-CPX-EA-DE	526439
		English	P.BE-CPX-EA-EN	526440
		Spanish	P.BE-CPX-EA-ES	526441
		French	P.BE-CPX-EA-FR	526442
		Italian	P.BE-CPX-EA-IT	526443
		Swedish	P.BE-CPX-EA-SV	526444

Terminal CPX

Technical data – Analogue module for inputs

Function

Analogue modules control devices with a standardised analogue interface such as pressure switches, temperature, flow rate, filling level, etc. Depending on the connection block selected, the analogue module supports various connection concepts with different numbers of sockets or terminals.

Application

- Analogue module for 0 ... 10 V, 0 ... 20 mA or 4 ... 20 mA
- Supports connection blocks with M12, Sub-D and terminal connection
- Analogue module features can be parameterised
- Different data formats available
- Operation with and without galvanic isolation possible
- The analogue module receives the voltage supply for the electronics and the sensors from the interlinking block
- Analogue module protection and diagnostics through integrated electronic fuse protection



General technical data			
Type	CPX-2AE-U-I		CPX-4AE-I
Part No.	526168		541484
	Voltage input	Current input	Current input
No. of analogue inputs	2		Choice of 2 or 4
Max. power supply per module [A]	0.7		
Fuse protection	Internal electronic fuse protection for sensor supply		
Current consumption from 24 V sensor supply (quiescent current) [mA]	Typically 50		
Current consumption from 24 V sensor supply (at full load) [A]	Max. 0.7		
Supply voltage of sensors [V DC]	24 ±2.5%		
Signal range (parameterisable for each channel by means of DIL switch or software)	0 ... 10 V DC	0 ... 20 mA 4 ... 20 mA	0 ... 20 mA 4 ... 20 mA
Resolution [bit]	12		
No. of units	4096		
Absolute accuracy [%]	±0.5	±0.6	±0.6
Linearity errors (no software scaling) [%]	±0.05	±0.05	±0.05
Repetition accuracy (at 25 °C) [%]	0.15	0.15	0.15
Input resistance [kΩ]	100	≤ 0,1	≤ 0,1
Max. permissible input voltage [V DC]	30	–	–
Max. permissible input current [mA]	–	40	40
Conversion time per channel [µs]	Typically 150		
Cycle time (module) [ms]	≤ 4		≤ 10

Terminal CPX

Technical data – Analogue module for inputs

FESTO

General technical data		
Type	CPX-2AE-U-I	CPX-4AE-I
Part No.	526168	541484
Data format	Prefix + 15 bit, linear scaling Prefix + 12 bit right-justified, type 03 compatible Prefix + 15 bit left-aligned, S7 compatible Prefix + 12 bit left-aligned + diagnostics, S5 compatible	
Cable length	Max. 30 m (screened)	
Galvanic isolation	Channel – Channel	No
	Channel – Internal bus	Yes, with external sensor supply
	Channel – Sensor supply	Yes, with external sensor supply
LED displays	Group diagnostics	1
	Channel diagnostics	Yes, by means of flashing frequency of group diagnostics
Diagnostics	<ul style="list-style-type: none"> • Short circuit/overload, sensor supply • Parameterisation errors • Value falling below nominal range/full-scale value • Value exceeding nominal range/full-scale value • Wire break (with measuring range 4 ... 20 mA) 	
Parameterisation	<ul style="list-style-type: none"> • Short circuit monitoring, sensor supply • Behaviour after short circuit, sensor supply • Data format • Lower limit value/full-scale value • Upper limit value/full-scale value • Monitoring of value falling below nominal range/full-scale value • Monitoring of value exceeding nominal range/full-scale value • Monitoring of wire break (with measuring range 4 ... 20 mA) • Signal range • Measured value smoothing 	
Protection class to EN 60529	Depending on connection block	
Temperature range	Operation	[°C] -5 ... +50
	Storage/transport	[°C] -20 ... +70
Materials	Polymer	
Grid dimension	[mm]	50
Dimensions (including interlinking block and connection block)	[mm]	50 x 107 x 50
W x L x H		
Weight	[g]	38

Internal structure, basic representation

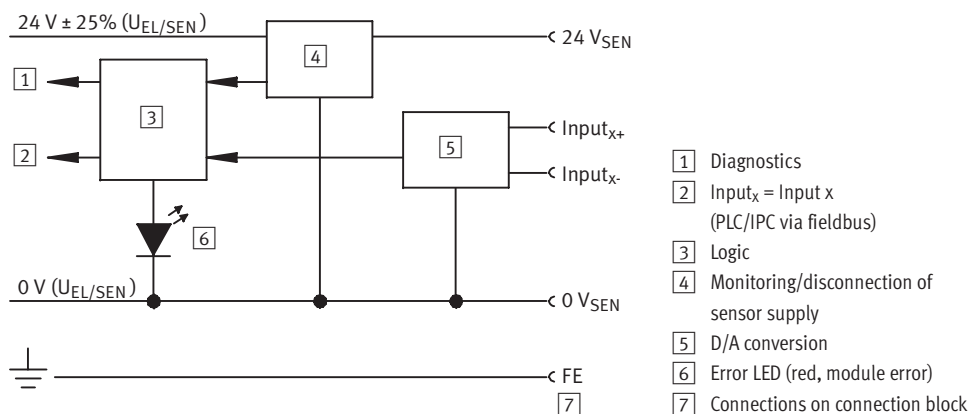

Terminal CPX

Technical data – Analogue module for inputs

Connection and display components

CPX-2AE-U-I and CPX-4AE-I

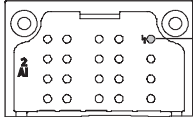

1 Error LED (red, module error)

Connection block/analogue module combinations

Connection blocks	Part No.	Analogue module	
		CPX-2AE-U-I	CPX-4AE-I
CPX-AB-4-M12X2-5POL	195704	■	■
CPX-AB-4-M12X2-5POL-R	541254	■	■
CPX-AB-8-KL-4POL	195708	■	■
CPX-AB-1-SUB-BU-25POL	525676	■	■
CPX-AB-4-M12x2-5P-R-M3	546997	■	■
CPX-M-4-M12x2-5POL	549367	■	■

Pin allocation

Connection block inputs	CPX-2AE-U-I	CPX-4AE-I
CPX-AB-4-M12X2-5POL, CPX-AB-4-M12X2-5POL-R ¹⁾ , CPX-M-4-M12x2-5POL and CPX-AB-4-M12x2-5P-R-M3 ¹⁾		
	<p>X1.1: 24 V_{SEN} X1.2: Input U0+ X1.3: 0 V_{SEN} X1.4: Input U0- X1.5: FE²⁾</p> <p>X2.1: 24 V_{SEN} X2.2: Input I0+ X2.3: 0 V_{SEN} X2.4: Input I0- X2.5: FE²⁾</p>	<p>X3.1: 24 V_{SEN} X3.2: Input U1+ X3.3: 0 V_{SEN} X3.4: Input U1- X3.5: FE²⁾</p> <p>X4.1: 24 V_{SEN} X4.2: Input I1+ X4.3: 0 V_{SEN} X4.4: Input I1- X4.5: FE²⁾</p>
CPX-AB-8-KL-4POL		
	<p>X1.0: 24 V_{SEN} X1.1: 0 V_{SEN} X1.2: Input U0- X1.3: FE</p> <p>X2.0: n.c. X2.1: n.c. X2.2: Input U0+ X2.3: FE</p> <p>X3.0: 24 V_{SEN} X3.1: 0 V_{SEN} X3.2: Input I0- X3.3: FE</p> <p>X4.0: n.c. X4.1: n.c. X4.2: Input I0+ X4.3: FE</p>	<p>X5.0: 24 V_{SEN} X5.1: 0 V_{SEN} X5.2: Input U1- X5.3: FE</p> <p>X6.0: n.c. X6.1: n.c. X6.2: Input U1+ X6.3: FE</p> <p>X7.0: 24 V_{SEN} X7.1: 0 V_{SEN} X7.2: Input I1- X7.3: FE</p> <p>X8.0: n.c. X8.1: n.c. X8.2: Input I1+ X8.3: FE</p>

1) Speedcon quick lock, metal thread with additional screening
 2) FE/metal thread with additional screening

Terminal CPX

Accessories – Analogue module for inputs

FESTO

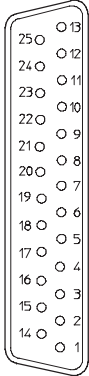
Pin allocation				
Connection block inputs	CPX-2AE-U-I		CPX-4AE-I	
CPX-AB-1-SUB-BU-25POL				
	1: Input U0- 2: Input U0+ 3: Input I0- 4: Input I1+ 5: n.c. 6: n.c. 7: n.c. 8: n.c. 9: 24 V _{SEN} 10: 24 V _{SEN} 11: 0 V _{SEN} 12: 0 V _{SEN} 13: Screening ¹⁾	14: Input U1- 15: Input U1+ 16: Input I1- 17: Input I1+ 18: 24 V _{SEN} 19: n.c. 20: 24 V _{SEN} 21: n.c. 22: 0 V _{SEN} 23: 0 V _{SEN} 24: 0 V _{SEN} 25: FE Socket: FE	1: Input I0- 2: Input I0+ 3: Input I1- 4: Input I1+ 5: n.c. 6: n.c. 7: n.c. 8: n.c. 9: 24 V _{SEN} 10: 24 V _{SEN} 11: 0 V _{SEN} 12: 0 V _{SEN} 13: Screening ¹⁾	14: Input I2- 15: Input I2+ 16: Input I3- 17: Input I3+ 18: 24 V _{SEN} 19: n.c. 20: 24 V _{SEN} 21: n.c. 22: 0 V _{SEN} 23: 0 V _{SEN} 24: 0 V _{SEN} 25: FE Socket: FE

1) Connect screening to functional earth FE

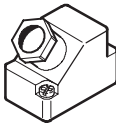
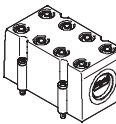
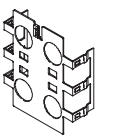
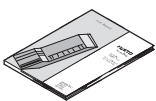
Ordering data			
Designation	Type	Part No.	
Plug			
	M12 plug, 5-pin	SEA-M12-5GS-PG7	175487
	Sub-D plug, 25-pin	SD-SUB-D-ST25	527522
Cover			
	Cover for CPX-AB-8-KL-4POL (IP65/67) – 8 cable through-feeds M9 – 1 cable through-feed for multi-pin plug	AK-8KL	538219
	Fittings kit	VG-K-M9	538220
Screening plate			
	Screening plate for M12 connections	CPX-AB-S-4-M12	526184
User documentation			
	User documentation	German	P.BE-CPX-AX-DE 526415
		English	P.BE-CPX-AX-EN 526416
		Spanish	P.BE-CPX-AX-ES 526417
		French	P.BE-CPX-AX-FR 526418
		Italian	P.BE-CPX-AX-IT 526419
		Swedish	P.BE-CPX-AX-SV 526420

Terminal CPX

Technical data – Analogue module for temperature inputs

Function

The CPX-PT100 analogue input module with 4 channels for temperature measurement enables the connection of up to 4 temperature sensors of type PT100-PT1000, Ni100-Ni1000 etc. Depending on the connection block selected, the temperature module supports various connection concepts with different numbers of sockets or terminals.

Application

- Temperature module for temperature sensors PT100, PT200, PT500, PT1000, Ni100, Ni120, Ni500, Ni1000
- Supports connection blocks with M12, Harax and terminal connection
- Temperature module features can be parameterised
- 2-wire, 3-wire and 4-wire connection
- The temperature module receives the voltage supply for the electronics and the sensors from the interlinking block
- Temperature module protection and diagnostics through integrated electronic fuse protection



General technical data			
Type	CPX-4AE-T		
Part No.	541486		
	Temperature input		
No. of analogue inputs	Choice of 2 or 4		
Max. power supply per module	[A]	0.7	
Fuse protection	Internal electronic fuse protection for sensor supply		
Current consumption from 24 V sensor supply (quiescent current)	[mA]	Typically 50	
Supply voltage of sensors	[V DC]	24 ±25%	
Sensor type (parameterisable for each channel by means of DIL switch)	PT100, PT200, PT500, PT1000 Ni100, Ni120, Ni500, Ni1000		
Temperature range	Pt standard	[°C]	-200 ... +850
	Pt climatic	[°C]	-120 ... +130
	Ni	[°C]	-60 ... +180
Sensor connection technology	2-wire, 3-wire and 4-wire technology		
Resolution	15 bit + prefix		
Operating error limit relative to input range	[%]	±0.06	
Basic error limit (25 °C)	Standard	[K]	±0.6
	Pt climatic	[K]	±0.2
Temperature errors relative to input range	[%]	±0.001	
Linearity errors (no software scaling)	[%]	±0.02	
Repetition accuracy (at 25 °C)	[%]	±0.05	
Max. cable resistance per conductor	[Ω]	10	
Max. permissible input voltage	[V]	±30	
Cycle time (module)	[ms]	≤ 250	

Terminal CPX

Technical data – Analogue module for temperature inputs

General technical data		
Type	CPX-4AE-T	
Part No.	541486	
Data format	15 bit + prefix, complement of two, binary notation in tenths of a degree	
Cable length	[m]	Max. 200 (screened)
Galvanic isolation	Channel – Channel	No
	Channel – Internal bus	Yes
LED displays	Group diagnostics	1
	Channel diagnostics	4
Diagnostics	<ul style="list-style-type: none"> • Short circuit/overload channel • Parameterisation errors • Value falling below nominal range/full-scale value • Value exceeding nominal range/full-scale value • Wire break 	
Parameterisation	<ul style="list-style-type: none"> • Unit of measurement and interference frequency suppression • Diagnostic message in the event of a wire break or short circuit • Limit monitoring per channel • Sensor connection technology • Sensor type/temperature coefficient, temperature range • Limit value per channel • Measured value smoothing 	
Protection class to EN 60529	Depending on connection block	
Temperature range	Operation	[°C] -5 ... +50
	Storage/transport	[°C] -20 ... +70
Materials	Polymer	
Grid dimension	[mm]	50
Dimensions (including interlinking block and connection block)	[mm]	50 x 107 x 50
W x L x H		
Weight	[g]	38

Connection and display components

CPX-4AE-T

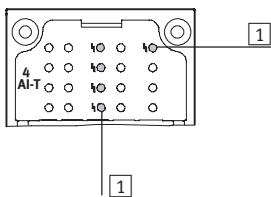

- 1 Error LED (red)
- 2 Channel-oriented error LEDs (red)

Connection block/analogue module combinations		
Connection blocks	Part No.	Temperature module
		CPX-4AE-T
CPX-AB-4-M1 2X2-5POL	195704	■
CPX-AB-4-M1 2X2-5POL-R	541254	■
CPX-AB-8-KL-4POL	195708	■
CPX-AB-4-HAR-4POL	525636	■
CPX-AB-4-M1 2x2-5P-R-M3	546997	■
CPX-M-4-M1 2x2-5POL	549367	■

Terminal CPX

Technical data – Analogue module for temperature inputs

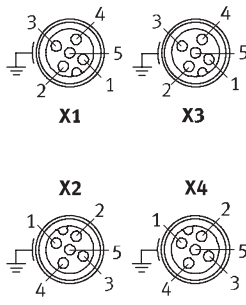
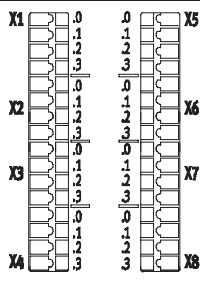
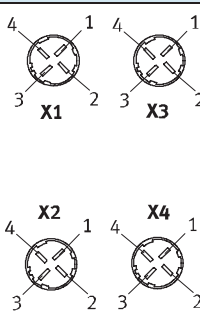
Pin allocation		
Connection block inputs	CPX-4AE-T	
CPX-AB-4-M12X2-5POL, CPX-AB-4-M12X2-5POL-R ¹⁾ , CPX-AB-4-M12x2-5P-R-M3 ¹⁾ and CPX-M-4-M12x2-5POL		
	<p>X1.1: Input I0+</p> <p>X1.2: Input U0+</p> <p>X1.3: Input I0-</p> <p>X1.4: Input U0-</p> <p>X1.5: FE²⁾</p> <p>X2.1: Input I1+</p> <p>X2.2: Input U1+</p> <p>X2.3: Input I1-</p> <p>X2.4: Input U1-</p> <p>X2.5: FE²⁾</p>	<p>X3.1: Input I2+</p> <p>X3.2: Input U2+</p> <p>X3.3: Input I2-</p> <p>X3.4: Input U2-</p> <p>X3.5: FE²⁾</p> <p>X4.1: Input I3+</p> <p>X4.2: Input U3+</p> <p>X4.3: Input I3-</p> <p>X4.4: Input U3-</p> <p>X4.5: FE²⁾</p>
CPX-AB-8-KL-4POL		
	<p>X1.0: Input I0+</p> <p>X1.1: Input I0-</p> <p>X1.2: Input U0-</p> <p>X1.3: FE</p> <p>X2.0: n.c.</p> <p>X2.1: n.c.</p> <p>X2.2: Input U0+</p> <p>X2.3: FE</p> <p>X3.0: Input I1+</p> <p>X3.1: Input I1-</p> <p>X3.2: Input U1-</p> <p>X3.3: FE</p> <p>X4.0: n.c.</p> <p>X4.1: n.c.</p> <p>X4.2: Input U1+</p> <p>X4.3: FE</p>	<p>X5.0: Input I2+</p> <p>X5.1: Input I2-</p> <p>X5.2: Input U2-</p> <p>X5.3: FE</p> <p>X6.0: n.c.</p> <p>X6.1: n.c.</p> <p>X6.2: Input U12+</p> <p>X6.3: FE</p> <p>X7.0: Input I3+</p> <p>X7.1: Input I3-</p> <p>X7.2: Input U3-</p> <p>X7.3: FE</p> <p>X8.0: n.c.</p> <p>X8.1: n.c.</p> <p>X8.2: Input U3+</p> <p>X8.3: FE</p>
CPX-AB-4-HAR-4POL		
	<p>X1.1: Input I0+</p> <p>X1.2: Input U0+</p> <p>X1.3: Input I0-</p> <p>X1.4: Input U0-</p> <p>X2.1: Input I1+</p> <p>X2.2: Input U1+</p> <p>X2.3: Input I1-</p> <p>X2.4: Input U1-</p>	<p>X3.1: Input I2+</p> <p>X3.2: Input U2+</p> <p>X3.3: Input I2-</p> <p>X3.4: Input U2-</p> <p>X4.1: Input I3+</p> <p>X4.2: Input U3+</p> <p>X4.3: Input I3-</p> <p>X4.4: Input U3-</p>



1) Speedcon quick lock, metal thread with additional screening

2) FE/metal thread with additional screening

Terminal CPX

Accessories – Analogue module for temperature inputs

FESTO

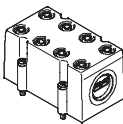
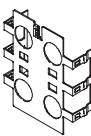
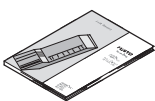
Ordering data				
Designation		Type	Part No.	
Plug				
	M12 plug, 5-pin	SEA-M12-5GS-PG7	175487	
	HARAX plug, 4-pin	SEA-GS-HAR-4POL	525928	
Cover				
	Cover for CPX-AB-8-KL-4POL (IP65/67) – 8 cable through-feeds M9 – 1 cable through-feed for multi-pin plug	AK-8KL	538219	
	Fittings kit	VG-K-M9	538220	
Screening plate				
	Screening plate for M12 connections	CPX-AB-S-4-M12	526184	
User documentation				
	User documentation	German	P.BE-CPX-AX-DE	526415
		English	P.BE-CPX-AX-EN	526416
		Spanish	P.BE-CPX-AX-ES	526417
		French	P.BE-CPX-AX-FR	526418
		Italian	P.BE-CPX-AX-IT	526419
		Swedish	P.BE-CPX-AX-SV	526420

Terminal CPX

Technical data – Analogue module for thermocoupler

Function

The CPX-4AE-TC analogue input module with four channels for temperature measurement enables up to four thermocoupler sensors to be connected. The channels feature wire break and short circuit detection. If no cold junction compensation sensor is being used, an internal theoretical value of 25 °C can be used (accuracy is impaired).

Application

- Supports connection blocks with M12 and terminal connection
- Temperature module features can be parameterised
- 2-wire connection
- 2-wire connection for a PT1000 sensor for cold junction compensation
- The temperature module is provided with voltage supply for the electronics and the sensors via the interlinking block
- Temperature module protection and diagnostics through integrated electronic fuse protection



General technical data		
Type		CPX-4AE-TC
Part No.		553594
		Temperature input
No. of analogue inputs		4
Fuse protection (short circuit)		Internal electronic fuse for each channel
Nominal operating voltage	[V DC]	24
Operating voltage range	[V DC]	18 ... 30
Sensor type (parameterisable for each channel by means of software)		<ul style="list-style-type: none"> • Type B +400 ... +1820 °C, 8 µV/°C • Type E -270 ... +900 °C, 60 µV/°C • Type J -200 ... +1200 °C, 51 µV/°C • Type K -200 ... +1370 °C, 40 µV/°C • Type N -200 ... +1300 °C, 38 µV/°C • Type R 0 ... +1760 °C, 12 µV/°C • Type S 0 ... +1760 °C, 11 µV/°C • Type T -200 ... +400 °C, 40 µV/°C
Sensor connection technology		2-wire technology
Operating error limit relative to ambient temperature	[%]	Max. ±0.6
Basic error limit (at 25 °C)	[%]	Max. ±0.4
Repetition accuracy (at 25 °C)	[%]	±0.05
Max. line resistance per conductor	[Ω]	10
Max. residual current per module	[mA]	30
Max. permissible input voltage	[V]	±30
Internal cycle time (module)	[ms]	250

Terminal CPX

Technical data – Analogue module for thermocoupler

General technical data		
Type	CPX-4AE-TC	
Part No.	553594	
Data format	<ul style="list-style-type: none"> • 15 bit + prefix, complement of two • Binary notation in tenths of a degree 	
Cable length	[m]	Max. 50 (screened)
Electrical isolation	Channel – channel	No
	Channel – Internal bus	Yes
LED displays	Group diagnosis	1
	Channel diagnosis	4
Diagnostics	<ul style="list-style-type: none"> • Parameterisation error • Wire break per channel • Limit value violation per channel 	
Parameterisation	<ul style="list-style-type: none"> • Wire break monitoring per channel • Unit of measurement • Cold junction compensation • Sensor type per channel • Limit value monitoring per channel • Measured value smoothing 	
Protection class to EN 60529	Depending on connection block	
Temperature range	Operation	[°C] -5 ... +50
	Storage/transport	[°C] -20 ... +70
Materials	Reinforced polyamide, polycarbonate	
Grid dimension	[mm]	50
Dimensions (incl. interlinking block and connection block) W x L x H	[mm]	50 x 107 x 50
Weight	[g]	38

Connection and display components

CPX-4AE-TC

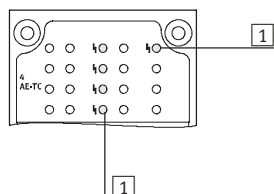

- 1 Fault LED (red, module error)
- 2 Channel-specific error LEDs (red)

Connection block/analogue module combinations

Connection blocks	Part No.	Temperature module
		CPX-4AE-TC
CPX-AB-4-M1 2X2-5POL	195704	■
CPX-AB-4-M1 2X2-5POL-R	541254	■
CPX-AB-8-KL-4POL	195708	■
CPX-AB-4-M1 2x2-5P-R-M3	546997	■
CPX-M-4-M1 2x2-5POL	549367	■

Terminal CPX

Technical data – Analogue module for thermocoupler

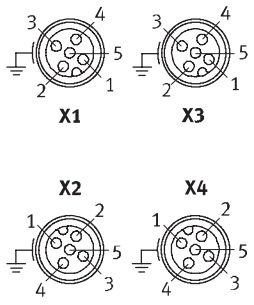
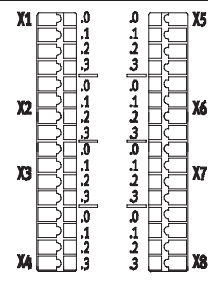

Pin allocation		
Connection block inputs	CPX-4AE-TC	
CPX-AB-4-M12X2-5POL, CPX-AB-4-M12X2-5POL-R ¹⁾ , CPX-AB-4-M12x2-5P-R-M3 ¹⁾ and CPX-M-4-M12x2-5POL		
	<p>X1.1: Input I0+</p> <p>X1.2: Input U0+</p> <p>X1.3: Input I0-</p> <p>X1.4: Input U0-</p> <p>X1.5: FE (earth)²⁾</p> <p>X2.1: Input I1+</p> <p>X2.2: Input U1+</p> <p>X2.3: Input I1-</p> <p>X2.4: Input U1-</p> <p>X2.5: FE (earth)²⁾</p>	<p>X3.1: Input I2+</p> <p>X3.2: Input U2+</p> <p>X3.3: Input I2-</p> <p>X3.4: Input U2-</p> <p>X3.5: FE (earth)²⁾</p> <p>X4.1: Input I3+</p> <p>X4.2: Input U3+</p> <p>X4.3: Input I3-</p> <p>X4.4: Input U3-</p> <p>X4.5: FE (earth)²⁾</p>
CPX-AB-8-KL-4POL		
	<p>X1.0: Input I0+</p> <p>X1.1: Input I0-</p> <p>X1.2: Input U0-</p> <p>X1.3: FE (earth)</p> <p>X2.0: n.c.</p> <p>X2.1: n.c.</p> <p>X2.2: Input U0+</p> <p>X2.3: FE (earth)</p> <p>X3.0: Input I1+</p> <p>X3.1: Input I1-</p> <p>X3.2: Input U1-</p> <p>X3.3: FE (earth)</p> <p>X4.0: n.c.</p> <p>X4.1: n.c.</p> <p>X4.2: Input U1+</p> <p>X4.3: FE (earth)</p>	<p>X5.0: Input I2+</p> <p>X5.1: Input I2-</p> <p>X5.2: Input U2-</p> <p>X5.3: FE (earth)</p> <p>X6.0: n.c.</p> <p>X6.1: n.c.</p> <p>X6.2: Input U12+</p> <p>X6.3: FE (earth)</p> <p>X7.0: Input I3+</p> <p>X7.1: Input I3-</p> <p>X7.2: Input U3-</p> <p>X7.3: FE (earth)</p> <p>X8.0: n.c.</p> <p>X8.1: n.c.</p> <p>X8.2: Input U3+</p> <p>X8.3: FE (earth)</p>

1) Speedcon quick lock, screening additionally on metal thread

2) FE/screening additionally on metal thread

Terminal CPX

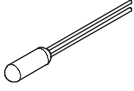
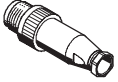
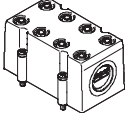
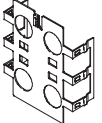
Accessories – Analogue module for thermocoupler

Ordering data				
Designation		Type	Part No.	
Cold junction compensation				
	PT1000 temperature sensor for cold junction compensation	CPX-W-PT1000	553596	
Plug				
	Plug connector M12, 5-pin	SEA-M12-5GS-PG7	175487	
Cover				
	Cover for CPX-AB-8-KL-4POL (IP65/67) – 8 cable through-feeds M9 – 1 cable through-feed for multi-pin plug	AK-8KL	538219	
	Fittings kit	VG-K-M9	538220	
Screening plate				
	Screening plate for M12 connections	CPX-AB-S-4-M12	526184	
User documentation				
	User documentation	German	P.BE-CPX-AX-DE	526415
		English	P.BE-CPX-AX-EN	526416
		Spanish	P.BE-CPX-AX-ES	526417
		French	P.BE-CPX-AX-FR	526418
		Italian	P.BE-CPX-AX-IT	526419
		Swedish	P.BE-CPX-AX-SV	526420

Terminal CPX

Technical data – Analogue module for outputs

Function

Analogue modules control devices with a standard analogue interface such as proportional valves, etc. Depending on the connection block selected, the analogue module supports various connection concepts with different numbers of sockets or terminals.

Application

- Analogue module for 0 ... 10 V, 0 ... 20 mA or 4 ... 20 mA
- Supports connection blocks with M12, Sub-D and terminal connection
- Analogue module features can be parameterised
- Different data formats available
- Operation with and without galvanic isolation possible
- The analogue module receives the voltage supply for the electronics and the actuators from the interlinking block
- Analogue module protection and diagnostics through integrated electronic fuse protection



General technical data				
Type	CPX-2AA-U-I			
Part No.	526170			
	Voltage output		Current output	
No. of analogue outputs	2			
Max. actuator supply per module	[A]	2.8		
Fuse protection	Internal electronic fuse protection for actuator supply			
Current consumption from 24 V sensor supply (at full load)	[mA]	Max. 150		
Current consumption from 24 V actuator supply (at full load)	[A]	4 ... 10		
Supply voltage for actuators	[V DC]	24 ±25%		
Signal range (parameterisable for each channel by means of DIL switch or software)		0 ... 10 V DC	0 ... 20 mA 4 ... 2 mA	
Resolution	[Bit]	12		
No. of units	4096			
Absolute accuracy	[%]	±0.6		
Linearity errors (no software scaling)	[%]	±0.1		
Repetition accuracy (at 25 °C)	[%]	0.05		
Encoder selection	Load resistance for ohmic load	[kΩ]	Min. 1	Max. 0.5
	Load resistance for capacitive load	[μF]	Max. 1	–
	Load resistance for inductive load	[mH]	–	Max. 1
	Short circuit protection analogue output		Yes	–
	Short circuit current analogue output	[mA]	Approx. 20	–
	Open circuit voltage	[V DC]	–	18
	Destruction limit against externally applied voltage	[V DC]	15	
	Actuator connection		2 wires	
Cycle time (module)	[ms]	≤ 4		

Terminal CPX

Technical data – Analogue module for outputs

General technical data			
Type	CPX-2AA-U-I		
Part No.	526170		
		Voltage output	Current output
Response time	for ohmic load	[ms]	0.1
	for capacitive load	[ms]	0.7
	for inductive load	[ms]	–
Data format			15 bit + prefix, linear scaling
			12 bit right-justified, type 03 compatible
			12 bit left-aligned, S7 compatible
			12 bit left-aligned, S5 compatible
Cable length	[m]	Max. 30 (screened)	
LED displays	Group diagnostics	1	
	Channel diagnostics	Yes, by means of flashing frequency of group diagnostics	
Diagnostics	<ul style="list-style-type: none"> • Short circuit/overload, actuator supply • Parameterisation errors • Value falling below nominal range/full-scale value • Value exceeding nominal range/full-scale value • Wire break 		
Parameterisation	<ul style="list-style-type: none"> • Short circuit monitoring, actuator supply • Short circuit monitoring, analogue output • Behaviour after short circuit, actuator supply • Data format • Lower limit value/full-scale value • Upper limit value/full-scale value • Monitoring of value falling below nominal range/full-scale value • Monitoring of value exceeding nominal range/full-scale value • Monitoring of wire break • Signal range 		
Protection class to EN 60529	Depending on connection block		
Temperature range	Operation	[°C]	–5 ... +50
	Storage/transport	[°C]	–20 ... +70
Materials	Polymer		
Grid dimension	[mm]	50	
Dimensions (including interlinking block and connection block)	[mm]	50 x 107 x 50	
W x L x H			
Weight	[g]	38	

Connection and display components

CPX-2AA-U-I

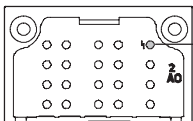

1 Error LED (red; module error)

Connection block/analogue module combinations			
Connection blocks	Part No.	Analogue module	
		CPX-2AA-U-I	
CPX-AB-4-M12X2-5POL	195704		■
CPX-AB-4-M12X2-5POL-R	541254		■
CPX-AB-8-KL-4POL	195708		■
CPX-AB-1-SUB-BU-25POL	525676		■
CPX-AB-4-M12x2-5P-R-M3	546997		■
CPX-M-4-M12x2-5POL	549367		■

Terminal CPX

Technical data – Analogue module for outputs

Pin allocation		
Connection block outputs	CPX-2AA-U-I	
CPX-AB-4-M12X2-5POL, CPX-AB-4-M12X2-5POL-R ¹⁾ , CPX-AB-4-M12x2-5P-R-M3 ¹⁾ , CPX-M-4-M12x2-5POL		
	<p>X1.1: 24 V_{OUT} X1.2: Output U₀+ X1.3: 0 V_{OUT} X1.4: Output GND X1.5: FE²⁾</p> <p>X2.1: 24 V_{OUT} X2.2: Output I₀+ X2.3: 0 V_{OUT} X2.4: Output GND X2.5: FE²⁾</p>	<p>X3.1: 24 V_{OUT} X3.2: Output U₁+ X3.3: 0 V_{OUT} X3.4: Output GND X3.5: FE²⁾</p> <p>X4.1: 24 V_{OUT} X4.2: Output I₁+ X4.3: 0 V_{OUT} X4.4: Output GND X4.5: FE²⁾</p>
CPX-AB-8-KL-4POL		
	<p>X1.0: 24 V_{OUT} X1.1: 0 V_{OUT} X1.2: Output GND X1.3: FE</p> <p>X2.0: n.c. X2.1: n.c. X2.2: Output U₀+ X2.3: FE</p> <p>X3.0: 24 V_{OUT} X3.1: 0 V_{OUT} X3.2: Output GND X3.3: FE</p> <p>X4.0: n.c. X4.1: n.c. X4.2: Output I₀+ X4.3: FE</p>	<p>X5.0: 24 V_{OUT} X5.1: 0 V_{OUT} X5.2: Output GND X5.3: FE</p> <p>X6.0: n.c. X6.1: n.c. X6.2: Output U₁+ X6.3: FE</p> <p>X7.0: 24 V_{OUT} X7.1: 0 V_{OUT} X7.2: Output GND X7.3: FE</p> <p>X8.0: n.c. X8.1: n.c. X8.2: Output I₁+ X8.3: FE</p>
CPX-AB-1-SUB-BU-25POL		
	<p>1: Output GND 2: Output U₀+ 3: Output GND 4: Output I₀+ 5: n.c. 6: n.c. 7: n.c. 8: n.c. 9: 24 V_{OUT} 10: 24 V_{OUT} 11: 0 V_{OUT} 12: 0 V_{OUT} 13: Screening³⁾</p>	<p>14: Output GND 15: Output U₁+ 16: Output GND 17: Output I₁+ 18: 24 V_{OUT} 19: n.c. 20: 24 V_{OUT} 21: n.c. 22: 0 V_{OUT} 23: 0 V_{OUT} 24: 0 V_{OUT} 25: FE Socket: FE</p>

1) Speedcon quick lock, metal thread with additional screening
 2) FE/metal thread with additional screening
 3) Connect screening to functional earth FE

Terminal CPX

Accessories – Analogue module for outputs

FESTO

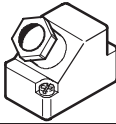
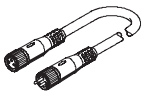
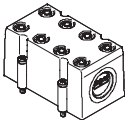
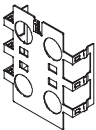
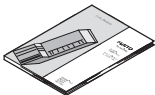
Ordering data				
Designation		Type	Part No.	
Plug				
	M12 plug, 5-pin	SEA-M12-5GS-PG7	175487	
	Sub-D plug, 25-pin	SD-SUB-D-ST25	527522	
Connecting cable				
	Modular system for connecting cables	NEBU-... ➔ Internet: nebu	–	
Cover				
	Cover for CPX-AB-8-KL-4POL (IP65/67) – 8 cable through-feeds M9 – 1 cable through-feed for multi-pin plug	AK-8KL	538219	
	Fittings kit	VG-K-M9	538220	
Screening plate				
	Screening plate for M12 connections	CPX-AB-S-4-M12	526184	
User documentation				
	User documentation	German	P.BE-CPX-AX-DE	526415
		English	P.BE-CPX-AX-EN	526416
		Spanish	P.BE-CPX-AX-ES	526417
		French	P.BE-CPX-AX-FR	526418
		Italian	P.BE-CPX-AX-IT	526419
		Swedish	P.BE-CPX-AX-SV	526420

Terminal CPX

Technical data – Interlinking block with system supply

Function

Interlinking blocks ensure the electrical supply of all other CPX modules. They have contact rails, from which the other CPX components using the interlinking modules are supplied with current.

Internal division of the power supply makes it possible to switch off specific areas of the sensors and actuators individually.

Application

- 24 V DC supply voltage for electronics of the CPX terminal
- 24 V DC supply voltage for inputs
- 24 V DC supply voltage for valves
- 24 V DC supply voltage for outputs



General technical data – Interlinking blocks made from plastic				
Type		CPX-GE-EV-S	CPX-GE-EV-S-7/8-4POL	CPX-GE-EV-S-7/8-5POL
Part No.		195746	541248	541244
Electrical connection		M18	7/8", 4-pin	7/8", 5-pin
Nominal operating voltage	[V DC]	24		
Current supply	Sensors and electronics	[A]	Max. 16	Max. 12
	Valves and outputs	[A]	Max. 16	Max. 12
Protection class to EN 60529		Depending on connection block		
Ambient temperature	[°C]	-5 ... +50		
Corrosion resistance class CRC ¹⁾		2		
Material declaration		Conforms to RoHS		
Materials		Polymer		
Grid dimension	[mm]	50		
Dimensions W x L x H	[mm]	50 x 107 x 35		

- 1) Corrosion resistance class 2 to Festo standard 940 070
Components subject to moderate corrosion stress. Externally visible parts with primarily decorative surface requirements which are in direct contact with a normal industrial environment or media such as coolants or lubricating agents.

General technical data – Interlinking blocks made from metal				
Type		CPX-M-GE-EV-S-7/8-5POL	CPX-M-GE-EV-S-PP-5POL	
Part No.		550208	563057	
Electrical connection		7/8", 5-pin	AIDA push-pull, 5-pin	
Nominal operating voltage	[V DC]	24		
Current supply	Sensors and electronics	[A]	Max. 8	Max. 16
	Valves and outputs	[A]	Max. 8	Max. 16
Protection class to EN 60529		Depending on connection block		
Ambient temperature	[°C]	-5 ... +50		
Material declaration		-	Conforms to RoHS	
Materials		Aluminium		
Grid dimension	[mm]	50		
Dimensions W x L x H	[mm]	50 x 107 x 35		

Terminal CPX

Technical data – Interlinking block with system supply

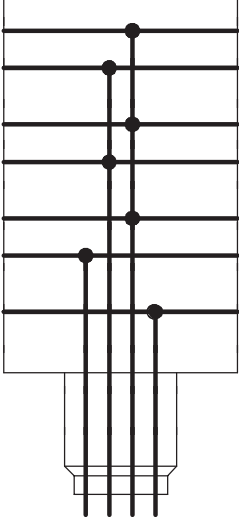
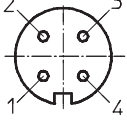
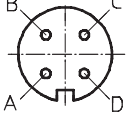
Pin allocation		Pin	Allocation																
Wiring allocation																			
	<p>0V Valves</p> <p>24V Valves</p> <p>0V Output</p> <p>24V Output</p> <p>0V El./Sen.</p> <p>24V El./Sen.</p> <p>FE</p>	M18 – 4-pin																	
			1	24 V DC supply voltage for electronics and sensors															
		2	24 V DC load voltage supply for valves and outputs																
		3	0 V																
		4	FE																
		7/8" – 4-pin																	
			A	24 V DC supply voltage for electronics and sensors															
			B	24 V DC load voltage supply for valves and outputs															
			C	FE															
			D	0V															
<table border="1" data-bbox="175 974 438 1086"> <tr> <td>M18</td> <td>1</td> <td>2</td> <td>3</td> <td>4</td> </tr> <tr> <td>7/8"</td> <td>A</td> <td>B</td> <td>D</td> <td>C</td> </tr> <tr> <td></td> <td>24V</td> <td>24V</td> <td>0V</td> <td>FE</td> </tr> </table>	M18	1	2	3	4	7/8"	A	B	D	C		24V	24V	0V	FE				
M18	1	2	3	4															
7/8"	A	B	D	C															
	24V	24V	0V	FE															

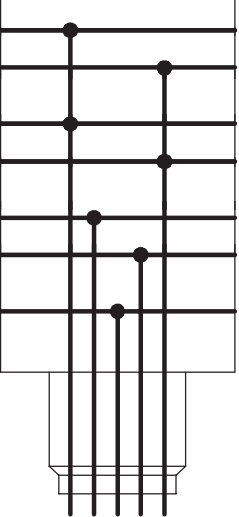
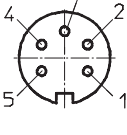
Pin allocation		Pin	Allocation													
Wiring allocation																
	<p>0V Valves</p> <p>24V Valves</p> <p>0V Output</p> <p>24V Output</p> <p>0V El./Sen.</p> <p>24V El./Sen.</p> <p>FE</p>	7/8" – 5-pin														
			1	0 V valves and outputs												
		2	0 V electronics and sensors													
		3	FE													
		4	24 V DC supply voltage for electronics and sensors													
		5	24 V DC load voltage supply for valves and outputs													
<table border="1" data-bbox="167 1803 478 1870"> <tr> <td>7/8"</td> <td>1</td> <td>2</td> <td>3</td> <td>4</td> <td>5</td> </tr> <tr> <td></td> <td>0V</td> <td>0V</td> <td>FE</td> <td>24V</td> <td>24V</td> </tr> </table>	7/8"	1	2	3	4	5		0V	0V	FE	24V	24V				
7/8"	1	2	3	4	5											
	0V	0V	FE	24V	24V											



Terminal CPX

Technical data – Interlinking block with system supply

Pin allocation		Pin	Allocation												
Wiring allocation															
<p>0V Valves 24V Valves 0V Output 24V Output 0V El./Sen. 24V El./Sen. FE</p> <table border="1"> <tr> <td>PP</td> <td>1</td> <td>2</td> <td>3</td> <td>4</td> <td>5</td> </tr> <tr> <td></td> <td>24V</td> <td>0V</td> <td>24V</td> <td>0V</td> <td>FE</td> </tr> </table>	PP	1	2	3	4	5		24V	0V	24V	0V	FE	<p>Push-pull – 5-pin (AIDA)</p>		
	PP	1	2	3	4	5									
		24V	0V	24V	0V	FE									
		1	24 V DC supply voltage for electronics and sensors												
		2	0 V electronics and sensors												
	3	24 V DC load voltage supply for valves and outputs													
	4	0 V valves and outputs													
	5	FE													

Terminal CPX

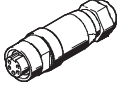
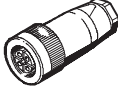
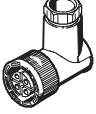
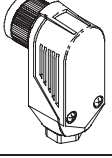
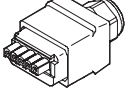
Accessories – Interlinking block with system supply

Ordering data				
Designation		Type	Part No.	
Connection sockets 7/8"				
	Power supply socket	5-pin	NECU-G78G5-C2	543107
		4-pin	NECU-G78G4-C2	543108
Connection sockets M18				
	Straight socket, screw terminal	4-pin, PG9	NTSD-GD-9	18493
		4-pin, PG13.5	NTSD-GD-13,5	18526
	Angled socket, screw terminal	4-pin, PG9	NTSD-WD-9	18527
	Angled socket, screw terminal	4-pin, PG11	NTSD-WD-11	533119
Connection socket AIDA push-pull				
	Socket, spring-loaded terminal	5-pin	NECU-M-PPG5-C1	563059
Mounting accessories				
	Screws for mounting the bus node/connection block on the plastic interlinking block	Metal bus node/connection block	CPX-DPT-30X32-S-4X	550218
	Screws for mounting the bus node/connection block on the metal interlinking block	Plastic bus node/connection block	CPX-M-M3x22-4x	550219
		Metal bus node/connection block	CPX-M-M3x22-S-4x	550216

Terminal CPX

Technical data – Interlinking block

Function

Interlinking blocks ensure the electrical supply of all other CPX modules. They have contact rails, from which the other CPX components using the interlinking modules are supplied with current.

Internal division of the power supply makes it possible to switch off specific areas of the sensors and actuators individually.

Application

- All voltages are fed through to the next module by means of system linking.
- The connected electronics module for inputs/outputs or bus nodes taps off the required voltage.



General technical data		
Type	CPX-GE-EV	CPX-M-GE-EV
Part No.	195742	550206
Electrical connection	–	–
Nominal operating voltage	[V DC] 24	24
Acceptable current load (per contact/contact rail)	[A] 16	8
Protection class to EN 60529	Depending on connection block	
Ambient temperature	[°C] –5 ... +50	
Corrosion resistance class CRC ¹⁾	2	–
Material declaration	Conforms to RoHS	
Materials	Polymer	Aluminium
Grid dimension	[mm] 50	
Dimensions W x L x H	[mm] 50 x 107 x 35	

1) Corrosion resistance class 2 to Festo standard 940 070
Components subject to moderate corrosion stress. Externally visible parts with primarily decorative surface requirements which are in direct contact with a normal industrial environment or media such as coolants or lubricating agents.

Pin allocation			
Wiring allocation		Pin	Allocation
		–	–
		–	–
		–	–
		–	–

Terminal CPX

Technical data – Interlinking block

Ordering data – Mounting accessories				
Designation			Type	Part No.
	Screws for mounting the bus node/connection block on the plastic interlinking block	Metal bus node/connection block	CPX-DPT-30X32-S-4X	550218
	Screws for mounting the bus node/connection block on the metal interlinking block	Plastic bus node/connection block	CPX-M-M3x22-4x	550219
		Metal bus node/connection block	CPX-M-M3x22-S-4x	550216

Terminal CPX

Technical data – Interlinking block with additional power supply for outputs

Function

Interlinking blocks ensure the electrical supply of all other CPX modules. They have contact rails, from which the other CPX components using the interlinking modules are supplied with current. Internal division of the power supply makes it possible to switch off specific areas of the sensors and actuators individually.

Application

- 24 V DC supply voltage for outputs

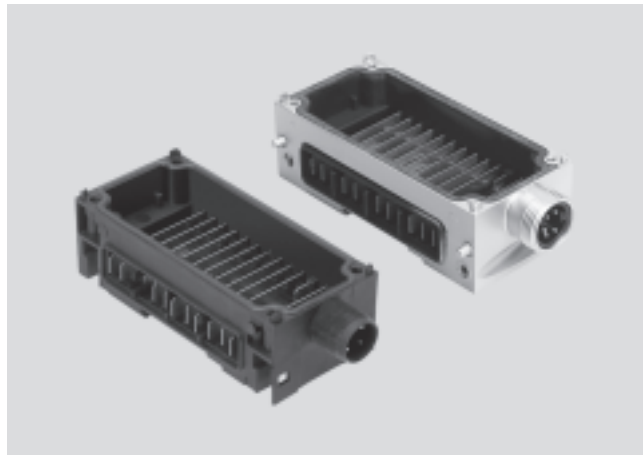

General technical data – Interlinking blocks made from plastic			
Type	CPX-GE-EV-Z	CPX-GE-EV-Z-7/8-4POL	CPX-GE-EV-Z-7/8-5POL
Part No.	195744	541250	541246
Electrical connection	M18	7/8", 4-pin	7/8", 5-pin
Nominal operating voltage	[V DC]	24	
Current supply	Outputs	[A]	Max. 16
Protection class to EN 60529	Depending on connection block		
Ambient temperature	[°C]	–5 ... +50	
Corrosion resistance class CRC ¹⁾	2		
Material declaration	Conforms to RoHS		
Materials	Polymer		
Grid dimension	[mm]	50	
Dimensions W x L x H	[mm]	50 x 107 x 35	

1) Corrosion resistance class 2 to Festo standard 940 070
Components subject to moderate corrosion stress. Externally visible parts with primarily decorative surface requirements which are in direct contact with a normal industrial environment or media such as coolants or lubricating agents.

General technical data – Interlinking blocks made from metal			
Type	CPX-M-GE-EV-Z-7/8-5POL	CPX-M-GE-EV-Z-PP-5POL	
Part No.	550210	563058	
Electrical connection	7/8", 5-pin	AIDA push-pull, 5-pin	
Nominal operating voltage	[V DC]	24	
Current supply	Outputs	[A]	Max. 8
Protection class to EN 60529	Depending on connection block		
Ambient temperature	[°C]	–5 ... +50	
Material declaration	–	Conforms to RoHS	
Materials	Aluminium		
Grid dimension	[mm]	50	
Dimensions W x L x H	[mm]	50 x 107 x 35	



Terminal CPX

Technical data – Interlinking block with additional power supply for outputs

Pin allocation		Pin	Allocation												
Wiring allocation		Push-pull – 5-pin (AIDA)													
<p>0V Valves 24V Valves 0V Output 24V Output 0V El./Sen. 24V El./Sen. FE</p> <table border="1"> <tr> <td>PP</td> <td>1</td> <td>2</td> <td>3</td> <td>4</td> <td>5</td> </tr> <tr> <td></td> <td>n.c.</td> <td>n.c.</td> <td>24V</td> <td>0V</td> <td>FE</td> </tr> </table>	PP	1	2	3	4	5		n.c.	n.c.	24V	0V	FE		1	n.c.
	PP	1	2	3	4	5									
		n.c.	n.c.	24V	0V	FE									
			2	n.c.											
			3	24 V DC load voltage supply for outputs											
		4	0 V outputs												
		5	FE												

Terminal CPX

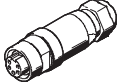
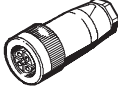
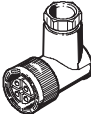
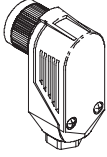
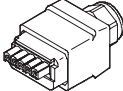
Accessories – Interlinking block with additional power supply for outputs

Ordering data				
Designation		Type	Part No.	
Connection sockets 7/8"				
	Power supply socket	5-pin	NECU-G78G5-C2	543107
		4-pin	NECU-G78G4-C2	543108
Connection sockets M18				
	Straight socket, screw terminal	4-pin, PG9	NTSD-GD-9	18493
		4-pin, PG13.5	NTSD-GD-13,5	18526
	Angled socket, screw terminal	4-pin, PG9	NTSD-WD-9	18527
	Angled socket, screw terminal	4-pin, PG11	NTSD-WD-11	533119
Connection socket AIDA push-pull				
	Socket, spring-loaded terminal	5-pin	NECU-M-PPG5-C1	563059
Mounting accessories				
	Screws for mounting the bus node/connection block on the plastic interlinking block	Metal bus node/connection block	CPX-DPT-30X32-S-4X	550218
	Screws for mounting the bus node/connection block on the metal interlinking block	Plastic bus node/connection block	CPX-M-M3x22-4x	550219
		Metal bus node/connection block	CPX-M-M3x22-S-4x	550216

Terminal CPX

Technical data – Interlinking block with additional power supply for valves

Function

Interlinking blocks ensure the electrical supply of all other CPX modules. They have contact rails, from which the other CPX components using the interlinking modules are supplied with current. Internal division of the power supply makes it possible to switch off specific areas of the sensors and actuators individually.

Application

- 24 V DC supply voltage for valves



General technical data		
Type	CPX-GE-EV-V	CPX-GE-EV-V-7/8-4POL
Part No.	533577	541252
Electrical connection	M18	7/8 , 4-pin
Nominal operating voltage	[V DC]	24
Acceptable current load (per contact/contact rail)	[A]	16
Protection class to EN 60529	Depending on connection block	
Ambient temperature	[°C]	-5 ... +50
Corrosion resistance class CRC ¹⁾	2	
Material declaration	Conforms to RoHS	
Materials	Polymer	
Grid dimension	[mm]	50
Dimensions W x L x H	[mm]	50 x 107 x 35

1) Corrosion resistance class 2 to Festo standard 940 070
Components subject to moderate corrosion stress. Externally visible parts with primarily decorative surface requirements which are in direct contact with a normal industrial environment or media such as coolants or lubricating agents.

Terminal CPX

Technical data – Pneumatic interface MPA

Function

The pneumatic interface MPA establishes the electromechanical connection between the terminal CPX and the valve terminal MPA.

The signals from the bus node are forwarded to the control electronics in the electrical modules of the valve terminal MPA via the integrated CPX bus. The bus signal for activation of the solenoid coils is converted in the electronics module for 4 valves (max. 8 coils).

From a technical point of view, the individual MPA pneumatic modules each represent a separate electrical module with digital outputs. Valves, which are galvanically isolated, can be supplied with power via the interlinking block CPX-GE-EV-V.

Application

- Interface to the valve terminal MPA
- Max. 128 solenoid coils
- Max. 16 electronic modules
- Features of the electronics module of the valve terminal MPA can be parameterised, e.g. status of the solenoid coils in the event of field-bus communication being interrupted (fail-safe), individual channel diagnostics can be activated, condition monitoring can be activated individually for each valve
- The pneumatic interface receives the voltage for the electronics and the supply voltage for the valves from the left-hand interlinking block and feeds them through to the electronics modules of the valve terminal MPA
- Electronics modules of the valve terminal MPA:
 - Undervoltage of valves
 - Short circuit of valves
 - Open load of valves
 - Counter preset reached in condition monitoring



Overview of pneumatic interface MPA and valve terminal MPA

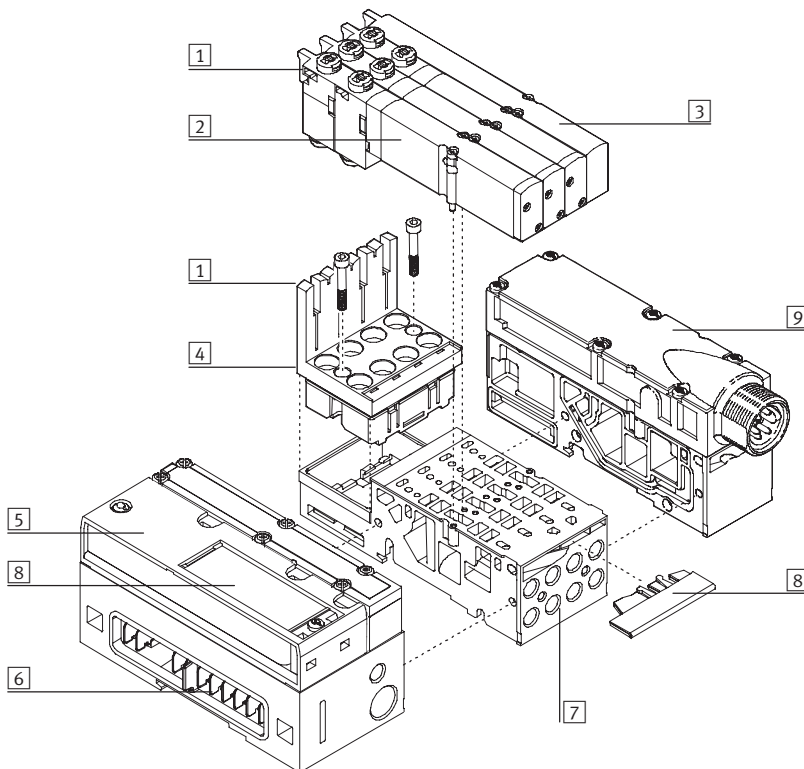

- 1 LEDs
 - Outputs (yellow)
 - Error (red)
 - Module error (all LEDs red)
- 2 Valves
- 3 Blanking plate
- 4 Electronics module
- 5 Pneumatic interface MPA
- 6 Power supply and bus connection
- 7 Manifold block
- 8 Inscription fields
- 9 Valve power supply (creation of zones with power supply that can be activated separately)

Terminal CPX

Technical data – Pneumatic interface VTSA/VTSA-F

Function

The pneumatic interface VTSA establishes the electromechanical connection between the terminal CPX and the valve terminal type 44 VTSA/ type 45 VTSA-F.

A complete pneumatic control loop system (FB-valve-drive-sensor-FB) can therefore be connected to the fieldbus using the input modules of the CPX terminal.

Different circuits for valves and electrical outputs are created using an additional power supply. The integrated valve diagnostic functions enable the causes of errors to be found quickly, therefore increasing system availability.

Application

- Interface for valve terminal VTSA and VTSA-F
- Max. 32 solenoid coils
- Address space allocation (configuration) of valve terminals can be set using integrated DIL switches
- Pneumatic interface features can be parameterised, e.g. status of the solenoid coils in the event of fieldbus communication being interrupted (fail-safe)
- The pneumatic interface receives the voltage for the electronics and the supply voltage for the valves from the left-hand interlinking block
- Detection of missing solenoid coils and short circuit monitoring for the valves



General technical data		
Type	VABA-S6-1-X1	VABA-S6-1-X2
Part No.	543416	550663
Connection for CPX interlinking blocks	Plastic	Metal
No. of solenoid coils	32	
Electrical actuation	Fieldbus	
Electrical connection	Via CPX	
Nominal operating voltage	[V DC]	24
Permissible voltage fluctuations	[%]	10
Protection class to EN 60529	IP65	
Ambient temperature	[°C]	-5 ... +50
Mounting position	Any	
Materials	Housing	Die-cast aluminium
	Top cover	Polyamide
Weight	[g]	485

Terminal CPX

Technical data – Pneumatic interface MIDI/MAXI

Function

The pneumatic interface MIDI/MAXI connects the valve terminal MIDI/MAXI to the supported fieldbus protocols of the terminal CPX. A complete pneumatic control loop system (FB-valve-drive-sensor-FB) can therefore be connected to the fieldbus using the input modules of the terminal CPX.

Different circuits for valves and electrical outputs are created using an additional power supply. The integrated valve diagnostic functions enable the causes of errors to be found quickly, therefore increasing system availability.

Application

- Interface to valve terminals MIDI/MAXI
- Max. 26 solenoid coils
- Address space allocation (configuration) of valve terminals can be set using integrated DIL switches
- Pneumatic interface features can be parameterised, e.g. status of the solenoid coils in the event of fieldbus communication being interrupted (fail-safe)
- The pneumatic interface receives the voltage for the electronics and the supply voltage for the valves from the left-hand interlinking block

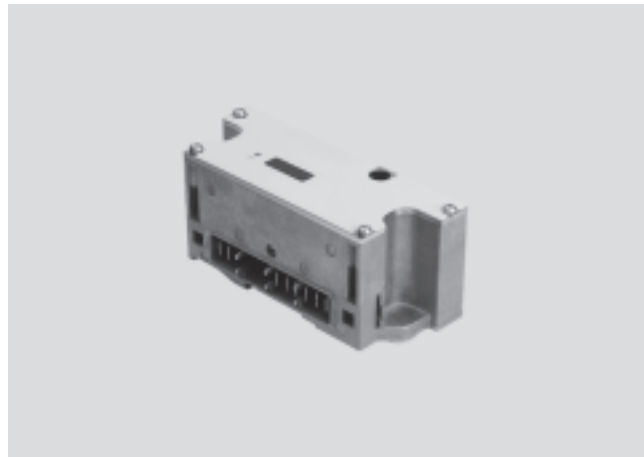

General technical data			CPX-GP-03-4,0	CPX-M-GP-03-4,0
Type			195738	556775
Part No.				
Connection for CPX interlinking blocks			Plastic	Metal
No. of solenoid coils			26	
Max. power supply	per module	[A]	4	
	per channel	[A]	0.2	
Fuse protection			Internal electronic fuse protection for each valve output	
Current consumption of modules for electronics		[mA]	Typ. 15	
Current consumption of modules for valves		[mA]	Typ. 30	
Nominal operating voltage		[V DC]	24	
Operating voltage range		[V DC]	21.6 ... 26.4	
Galvanic isolation	Channel – Channel		No	
	Channel – Internal bus		Yes, using an additional power supply for valves	
LED displays	Group diagnostics		1	
	Channel diagnostics		–	
	Channel status		– (on valves)	
Diagnostics			<ul style="list-style-type: none"> • Undervoltage of valves 	
Parameterisation			<ul style="list-style-type: none"> • Module monitoring • Fail-safe behaviour, channel x 	
Protection class to EN 60529			IP65	
Ambient temperature		[°C]	–5 ... +50	
Materials	Top cover		Steel	
			Die-cast aluminium	
Grid dimension		[mm]	50	
Dimensions W x L x H		[mm]	50 x 132 x 55	
Weight		[g]	390	

Terminal CPX

Accessories – Pneumatic interface MIDI/MAXI

Connection and display components

CPX-GP-03-4,0

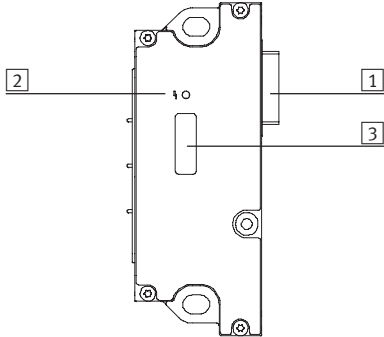

- 1 Connecting plug to valves
- 2 Error LED (red)
- 3 DIL switch under transparent cover

Ordering data

Designation	Type	Part No.	
H-rail mounting			
	For mounting CPX terminal and valve terminal MIDI on H-rail	CPX-03-4,0	526033
	For mounting CPX terminal and valve terminal MAXI on H-rail	CPX-03-7,0	526034

Terminal CPX

Technical data – Pneumatic interface CPA

Function

The pneumatic interface CPA connects the valve terminal CPA to the supported fieldbus protocols of the CPX terminal. A complete pneumatic control loop system (FB-valve-drive-sensor-FB) can therefore be connected to the fieldbus using the input modules of the CPX terminal. Different circuits for valves and electrical outputs are implemented using an additional power supply. The integrated valve diagnostic functions enable the causes of errors to be found quickly, therefore increasing system availability.

Application

- Interface to CPA10 and CPA14 valve terminals
- Max. 22 solenoid coils
- Address space allocation (configuration) of valve terminals can be set using integrated DIL switches
- Pneumatic interface features can be parameterised, e.g. status of the solenoid coils in the event of fieldbus communication being interrupted (fail-safe)
- The pneumatic interface receives the voltage for the electronics and the supply voltage for the valves from the left-hand interlinking block
- Detection of missing solenoid coils and short circuit monitoring for the valves



General technical data			
Type	CPX-GP-CPA-10		CPX-GP-CPA-14
Part No.	195710		195712
No. of solenoid coils	22		22
Max. power supply	per module	[A]	4
	per channel	[A]	0.2
Fuse protection	Internal electronic fuse protection for each valve output		
Current consumption of module from electronics/sensor supply	[mA]	Typ. 15	
Supply voltage for valves	[V DC]	24 +10% –15%	
Galvanic isolation	Channel – Channel	No	
	Channel – Internal bus	Yes, using an additional power supply for valves (in preparation)	
LED displays	Group diagnostics	1	
	Channel diagnostics	–	
	Channel status	– (on valves)	
Diagnostics	<ul style="list-style-type: none"> • Load voltage of valves • Short circuit solenoid coils (channel-oriented) • Wire break solenoid coils (channel-oriented quiescent current detection for valve solenoid coils) 		
Parameterisation	<ul style="list-style-type: none"> • Module monitoring • Wire break monitoring, channel x • Fail-safe behaviour, channel x 		
Protection class to EN 60529	IP65		
Temperature range	Operation	[°C]	–5 ... +50
	Storage/transport	[°C]	–20 ... +70
Materials	Polymer		
Grid dimension	[mm]	50	
Dimensions W x L x H	[mm]	50 x 110 x 58	
Weight	[g]	150	

Terminal CPX

Accessories – Pneumatic interface CPA

Connection and display components

CPX-GP-CPA-...

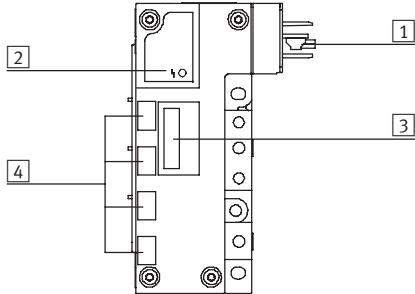

- 1 Connecting plug to valves
- 2 Error LED (red)
- 3 DIL switch under transparent cover
- 4 Inscription fields for addresses

Ordering data

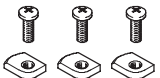
Designation	Type	Part No.
H-rail mounting		
 For mounting CPX terminal and valve terminal CPA on H-rail	CPX-CPA-BG-NRH	526032

Terminal CPX

Technical data

FESTO

Dimensions – CPX terminal, plastic linking

Download CAD data → www.festo.com

with bus nodes and connection blocks

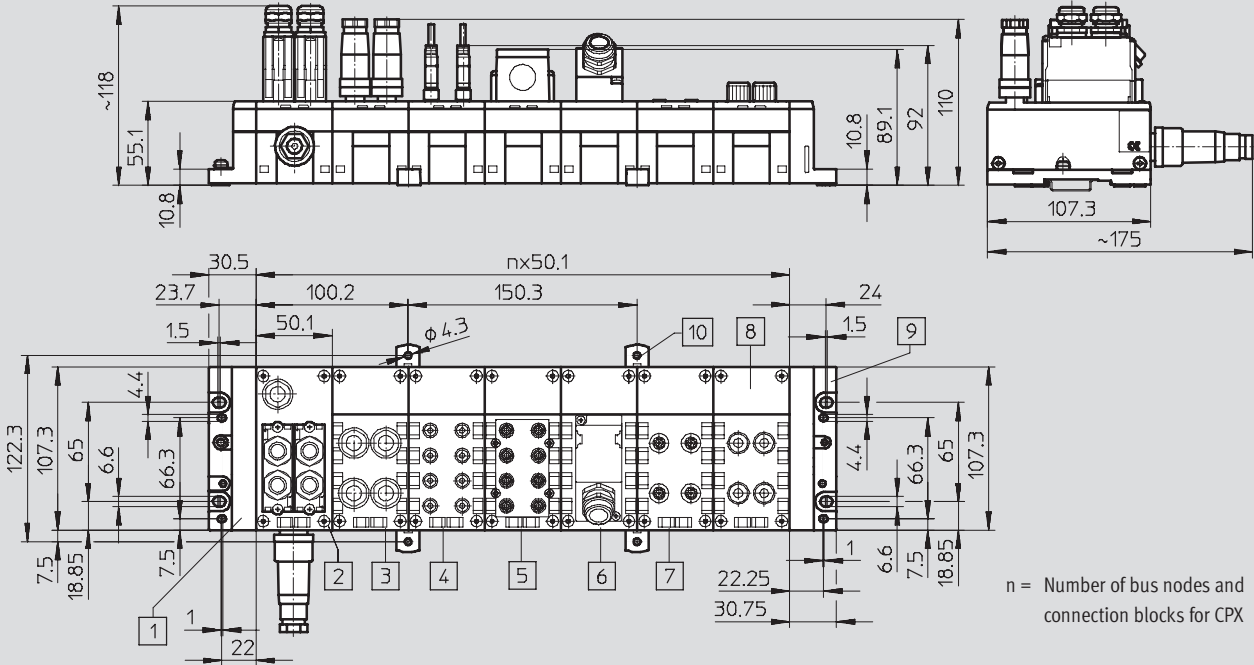

n = Number of bus nodes and connection blocks for CPX

- | | | | |
|---|-------------------------------------|--|---|
| 1 Left-hand end plate (earthing plate optional) | 4 Connection block CPX-AB-8-M8-3POL | 6 Connection block CPX-AB-1-SUB-BU-25POL | 8 Connection block CPX-AB-4-M12x2-5POL |
| 2 Bus node | 5 Connection block CPX-AB-8-KL-4POL | 7 Connection block CPX-AB-4-HAR-4POL | 9 Right-hand end plate |
| 3 Connection block CPX-AB-4-M12-8POL | | | 10 Mounting clip for wall mounting (required every 2 ... 3 connection blocks) |

Terminal CPX

Technical data

Dimensions – CPX terminal, metal linking
with bus nodes and connection blocks

Download CAD data → www.festo.com

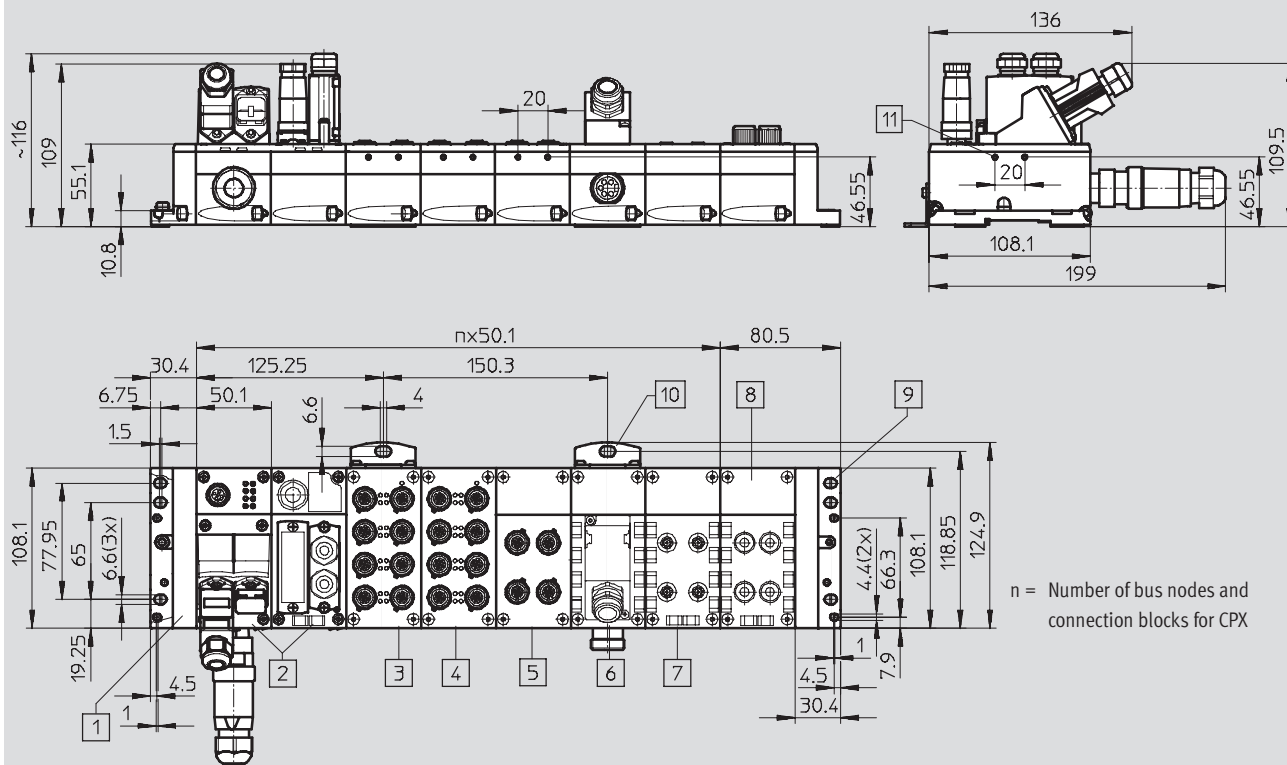

n = Number of bus nodes and connection blocks for CPX

- | | | | |
|--|--|---|---|
| 1 Left-hand end plate | 4 Connection block
CPX-M-8-M12x2-5POL | 6 Connection block
CPX-AB-1-SUB-BU-25POL | 8 Connection block
CPX-AB-4-HAR-4POL |
| 2 Bus node | 5 Connection block
CPX-M-4-M12x2-5POL | 7 Connection block
CPX-AB-4-M12-8POL | 9 Right-hand end plate |
| 3 Connection block
CPX-M-8-M12x2-5POL | | | 10 Mounting bracket for wall fitting |
| | | | 11 Hole for self-tapping screw
M2.5 |

Terminal CPX

Technical data

FESTO

Dimensions – CPX terminal

Download CAD data → www.festo.com

with bus nodes and valve terminal type 44 VTSA

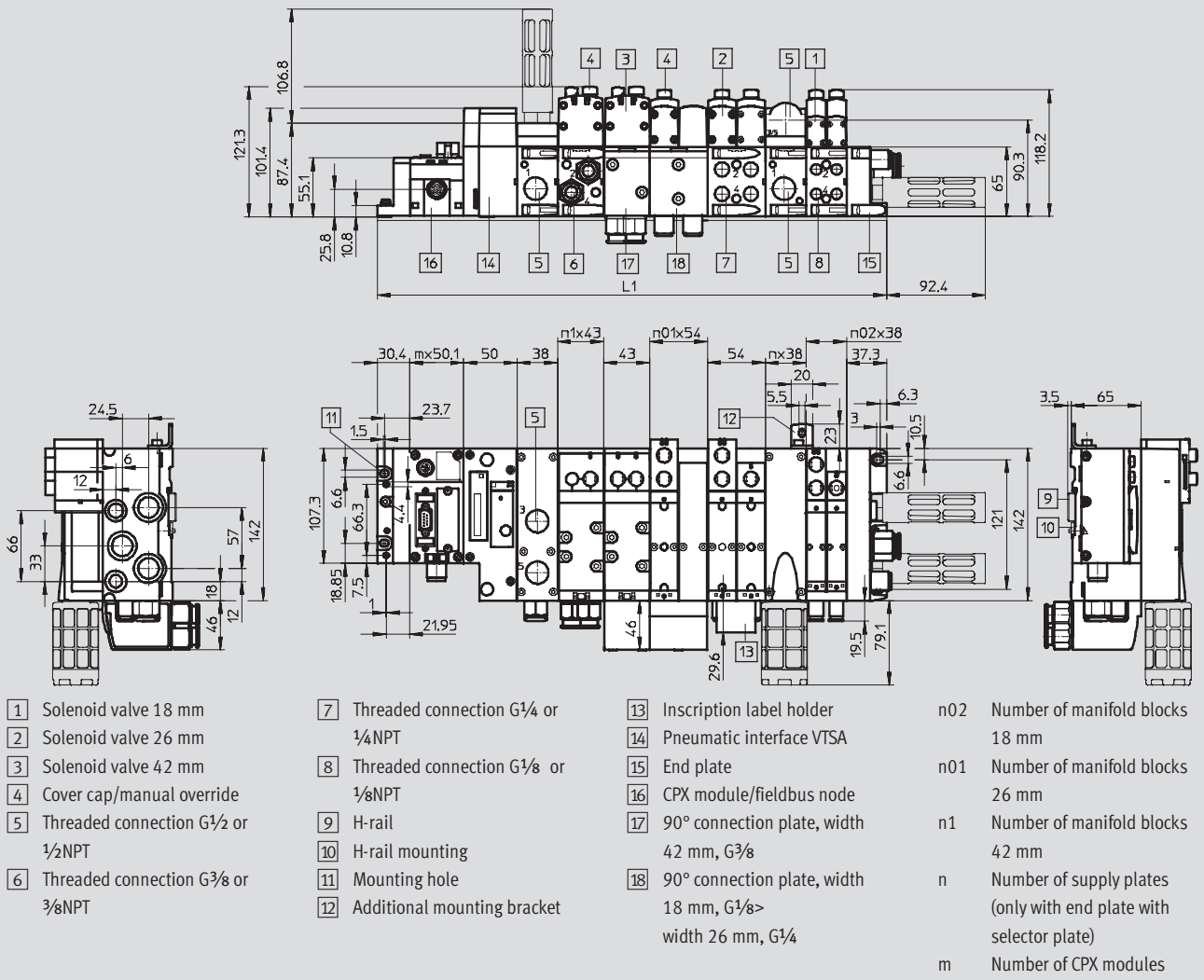

Width	L1
18 mm	$30.4 + m \times 50.1 + 50 + n02 \times 38 + n \times 38 + 37.3$
26 mm	$30.4 + m \times 50.1 + 50 + n01 \times 54 + n \times 38 + 37.3$
42 mm	$30.4 + m \times 50.1 + 50 + n1 \times 43 + n \times 38 + 37.3$
Mixture of 18 mm, 26 mm and 42 mm	$30.4 + m \times 50.1 + 50 + n02 \times 38 + n01 \times 54 + n1 \times 43 + n \times 38 + 37.3$

Terminal CPX

Technical data

FESTO

Dimensions – CPX terminal

Download CAD data → www.festo.com

with bus nodes and valve terminal type 45 VTSA-F

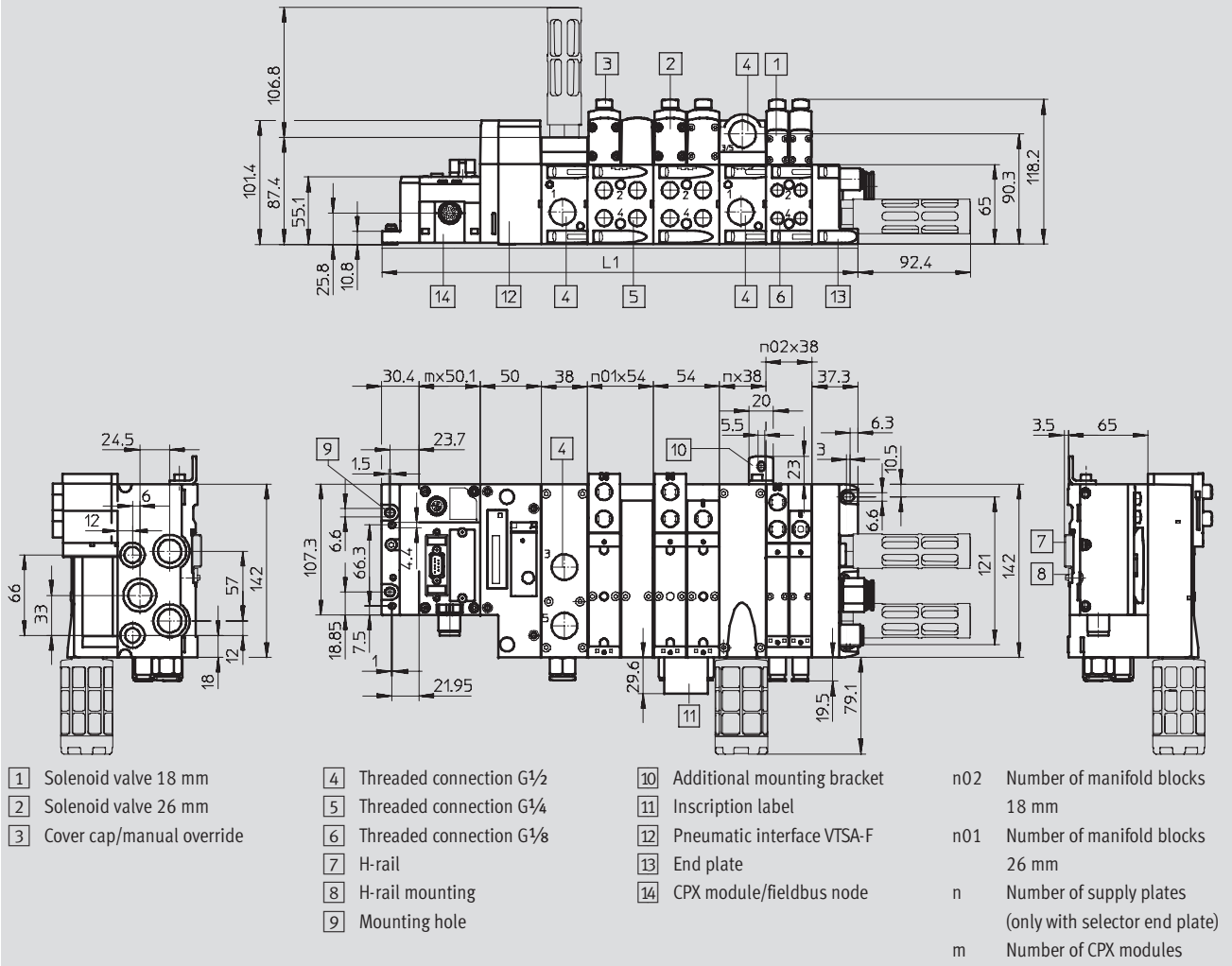

Width	L1
18 mm	$30.4 + m \times 50.1 + 50 + n02 \times 38 + n \times 38 + 37.3$
26 mm	$30.4 + m \times 50.1 + 50 + n01 \times 54 + n \times 38 + 37.3$
Mixture of 18 mm and 26 mm	$30.4 m \times 50.1 + 50 + n02 \times 38 + n01 \times 54 + n \times 38 + 37.3$

Terminal CPX

Technical data

FESTO

Dimensions – CPX terminal

Download CAD data → www.festo.com

with bus nodes, connection blocks and valve terminal CPA

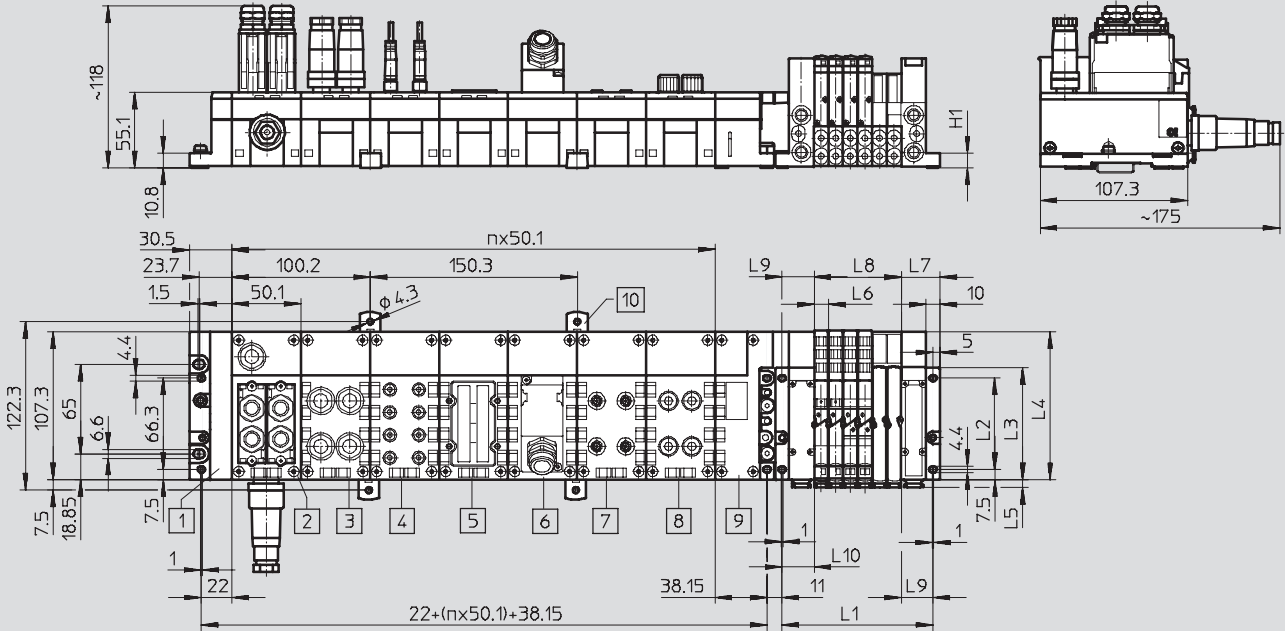

n = Number of bus nodes and connection blocks for CPX

- | | | | |
|---|---|---|---|
| 1 Left-hand end plate | 5 Connection block
CPX-AB-8-KL-4POL | 8 Connection block
CPX-AB-4-M12x2-5POL | 10 Mounting clip for wall
mounting (required every
2 ... 3 connection blocks) |
| 2 Bus node | 6 Connection block
CPX-AB-1-SUB-BU-25POL | 9 Pneumatic interface CPA | |
| 3 Connection block
CPX-AB-4-M12-8POL | 7 Connection block
CPX-AB-4-HAR-4POL | | |
| 4 Connection block
CPX-AB-8-M8-3POL | | | |

Type	L1 ¹⁾	L2 ±0.1	L3	L4	L5	L6	L7	L8 ¹⁾	L9 ±0.1	H1
CPA10	46 + (m x 10.6)	66.3	81.3	108.3	5.5	10.6	28	m x 10.6	23	10.8
CPA14	51 + (m x 14.6)	76.1	91.1	118.1	6.5	14.6	31	m x 14.6	26	13

1) m = Number of valves

Terminal CPX

Technical data

Dimensions – CPX terminal

Download CAD data → www.festo.com

with bus nodes and valve terminal MPA

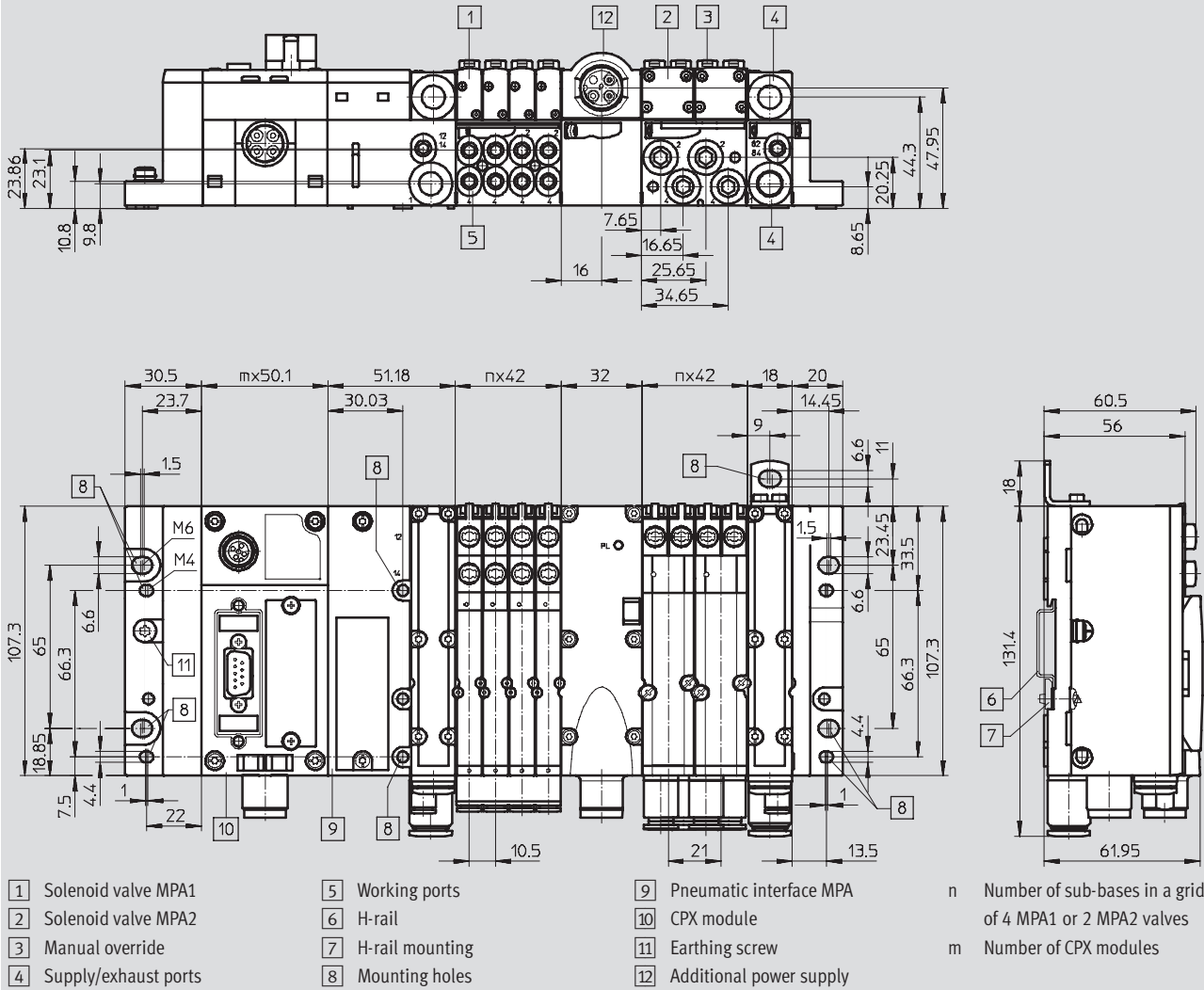

Terminal CPX

Technical data

FESTO

Dimensions – CPX terminal

with bus nodes, connection blocks and valve terminal MIDI/MAXI

Download CAD data → www.festo.com

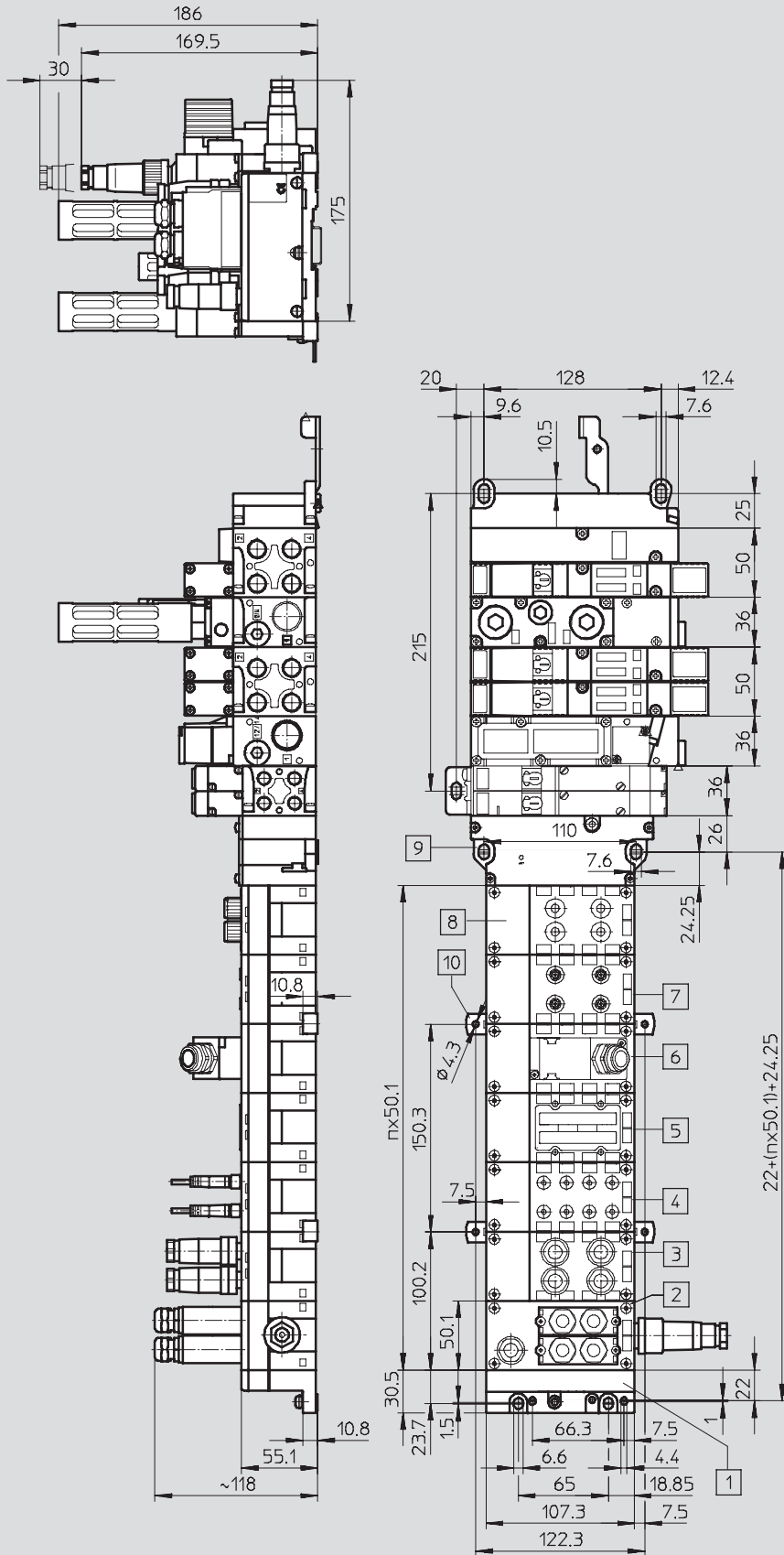









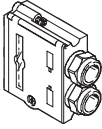

n = Number of bus nodes and connection blocks for CPX

- | | | | |
|---|---------------------------------------|----|--|
| 1 | Left-hand end plate | 6 | Connection block
CPX-AB-1-SUB-BU-25POL |
| 2 | Bus node | 7 | Connection block
CPX-AB-4-HAR-4POL |
| 3 | Connection block
CPX-AB-4-M12-8POL | 8 | Connection block
CPX-AB-4-M12x2-5POL |
| 4 | Connection block
CPX-AB-8-M8-3POL | 9 | Pneumatic interface
MIDI/MAXI |
| 5 | Connection block
CPX-AB-8-KL-4POL | 10 | Mounting clip for wall
mounting (required every
2 ... 3 connection blocks) |

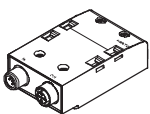
Terminal CPX

Accessories

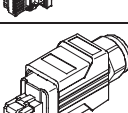



FESTO

Ordering data – Accessories				
Designation			Type	Part No.
Plug connectors and accessories				
	Sub-D plug for INTERBUS	Incoming	FBS-SUB-9-BU-IB-B	532218
		Outgoing	FBS-SUB-9-GS-IB-B	532217
	Sub-D plug for DeviceNet/CANopen		FBS-SUB-9-BU-2x5POL-B	532219
	Sub-D plug for Profibus DP		FBS-SUB-9-GS-DP-B	532216
	Sub-D plug for CC-Link		FBS-SUB-9-GS-2x4POL-B	532220
Sub-D plug		FBS-SUB-9-GS-1x9POL-B	534497	
	Bus connection M12 adapter (B-coded) for Profibus DP		FBA-2-M12-5POL-RK	533118
	Bus connection Micro Style 2xM12 for DeviceNet/CANopen		FBA-2-M12-5POL	525632
	Plug socket for Micro Style connection, M12		FBSD-GD-9-5POL	18324
	Plug connector for Micro Style connection, M12		FBS-M12-5GS-PG9	175380
	Bus connector M12x1, 4-pin (D-coded) for Ethernet		NECU-M-S-D12G4-C2-ET	543109
	Connection block M12 adapter (B-coded) for Profibus DP		CPX-AB-2-M12-RK-DP	541519
	Connection block M12 adapter (B-coded) for INTERBUS		CPX-AB-2-M12-RK-IB	534505
	Fieldbus connector Open Style for 5-pin terminal strip for DeviceNet/CANopen		FBA-1-SL-5POL	525634
	Terminal strip connector for Open Style connection, 5-pin		FBSD-KL-2x5POL	525635
	Bus connector screw terminal for CC-Link		FBA-1-KL-5POL	197962
	RJ45/plug		FBS-RJ45-8-GS	534494
	Plug RJ45, 8-pin, push-pull		FBS-RJ45-PP-GS	552000
	Socket/spring-loaded terminal, 5-pin, AIDA push-pull		NECU-M-PPG5-C1	563059
	Threaded sleeve, 4 pieces		UNC4-40/M3x6	533000

Terminal CPX

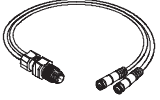
Accessories

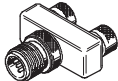
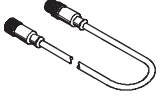
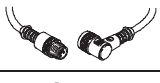

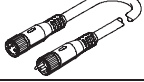
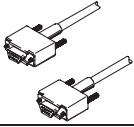
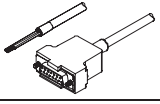
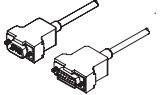

FESTO

Ordering data – Accessories					
Designation			Type	Part No.	
Connecting cables					
	DUO cable M12-2xM8, 4-pin/2x3-pin	2x straight socket	KM12-DUO-M8-GDGD	18685	
		2x straight/angled socket	KM12-DUO-M8-GDWD	18688	
		2x angled socket	KM12-DUO-M8-WDWD	18687	
	T-plug connector	2x socket M8, 3-pin 1x plug M8, 4-pin	NEDU-M8D3-M8T4	544391	
		T-plug connector	2x socket M12, 5-pin 1x plug M12, 4-pin	NEDU-M12D5-M12T4	541596
	T-plug connector		2x socket M8, 3-pin 1x plug M12, 4-pin	NEDU-M8D3-M12T4	541597
			Connecting cable M8-M8, between straight plug and straight socket	0.5 m	KM8-M8-GSGD-0,5
1.0 m	KM8-M8-GSGD-1			175489	
2.5 m	KM8-M8-GSGD-2,5			165610	
5.0 m	KM8-M8-GSGD-5			165611	
Extension cable M12-M12, 5-pin, between straight plug and straight socket	1.5 m			KV-M12-M12-1,5	529044
	3.5 m			KV-M12-M12-3,5	530901
Connecting cable M12-M12, 4-pin, between straight plug and straight socket	2.5 m			KM12-M12-GSGD-2,5	18684
	5.0 m	KM12-M12-GSGD-5	18686		
Connecting cable M12-M12, 8-pin, between straight plug and straight socket	2.0 m	KM12-8GD8GS-2-PU	525617		
	Connecting cable M12-M12, 4-pin, between straight plug and angled socket	1.0 m	KM12-M12-GSWD-1-4	185499	
			Connecting cable M9, between angled plug and angled socket	0.25 m	KVI-CP-3-WS-WD-0,25
0.5 m	KVI-CP-3-WS-WD-0,5			540328	
2 m	KVI-CP-3-WS-WD-2			540329	
5 m	KVI-CP-3-WS-WD-5			540330	
8 m	KVI-CP-3-WS-WD-8			540331	
	Connecting cable M9, between straight plug and straight socket	2 m	KVI-CP-3-GS-GD-2	540332	
		5 m	KVI-CP-3-GS-GD-5	540333	
		8 m	KVI-CP-3-GS-GD-8	540334	
	Modular system for connecting cables	NEBU-...		-	
		→ Internet: nebu			
	Programming cable	KDI-PPA-3-BU9		151915	
		Connecting cable FED	FEC-KBG7		539642
	Connecting cable FED		FEC-KBG8		
			Connecting cable FED	FEC-KBG8	

Terminal CPX

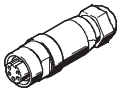
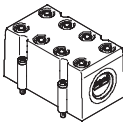
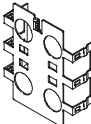
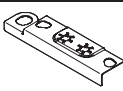
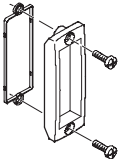
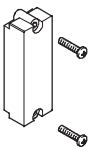
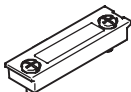
Accessories

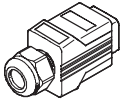





FESTO

Ordering data – Accessories				
Designation		Type	Part No.	
Plug connectors and accessories – Power supply				
	Plug socket for mains connection M18, straight	for 1.5 mm ²	NTSD-GD-9	18493
		for 2.5 mm ²	NTSD-GD-13,5	18526
	Plug socket for mains connection M18, angled	for 1.5 mm ²	NTSD-WD-9	18527
		for 2.5 mm ²	NTSD-WD-11	533119
	Power supply socket	7/8" connection, 5-pin	NECU-G78G5-C2	543107
		7/8" connection, 4-pin	NECU-G78G4-C2	543108
Covers and attachments				
	Cover for CPX-AB-8-KL-4POL (IP65/67) – 8 cable through-feeds M9 – 1 cable through-feed for multi-pin plug		AK-8KL	538219
	Fittings kit		VG-K-M9	538220
	Screening plate for M12 connections		CPX-AB-S-4-M12	526184
	Earthing component (5 pieces), for right-hand/left-hand plastic end plate		CPX-EPFE-EV	538892
	Inspection cover, transparent		AK-SUB-9/15-B	533334
	Inspection cover, for use in Atex environments as per certification (→ 44)		AK-SUB-9/15	557010
	Transparent cover for DIL switch and memory card		CPX-AK-P	548757
	Cover plate for DIL switch and memory card		CPX-M-AK-M	548754
	Cover for RJ45 connection		AK-Rj45	534496
	Cover for RJ45 push-pull connection		CPX-M-AK-C	548753
	Protective cap for sealing unused sockets (10 pieces)	for M8 connections	ISK-M8	177672
		M9	FLANSCHDOSE SER.712	356684
		for M12 connections	ISK-M12	165592

Terminal CPX

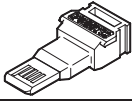
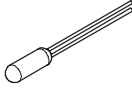
Accessories

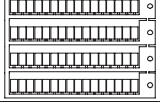
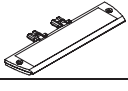
FESTO

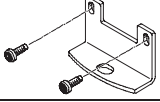
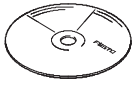
Ordering data – Accessories				
Designation		Type	Part No.	
Screws				
	Screws for mounting the bus node/connection block on the plastic interlinking block	Bus node/metal connection block	CPX-DPT-30X32-S-4X	550218
	Screws for mounting the bus node/connection block on the metal interlinking block	Bus node/plastic connection block	CPX-M-M3x22-4x	550219
		Bus node/metal connection block	CPX-M-M3x22-S-4x	550216
	Screws for attaching an inscription label holder to the fieldbus node FB33, FB34 (12 pieces)		CPX-M-M2,5X6-12X	550222
Functional modules				
	Memory card for PROFINET fieldbus node		CPX-SK	549526
	PT1000 temperature sensor for cold junction compensation		CPX-W-PT1000	553596
	Adapter cable M12, 5-pin at socket Mini-USB and controller software		NEFC-M12G5-0.3-U1G5	547432
Inscription labels				
	Inscription labels, 6x10, 64 pieces, in frames		IBS-6x10	18576
	Inscription label holder for connection block		CPX-ST-1	536593
Mounting				
	Attachment for wall mounting (for long valve terminals, 10 pieces), design for plastic manifold sub-bases		CPX-BG-RW-10x	529040
	Attachment for wall mounting (for long valve terminals, 2 mounting brackets and 4 screws), design for metal manifold sub-bases		CPX-M-BG-RW-2x	550217
Software				
	CPX remote diagnosis and process visualisation		CPX-WEB-MONITOR	545413
	Programming software	German	FST4.1DE	537927
		English	FST4.1GB	537928
	ePlan macro library		GSWC-TE-EP-LA	537041