



Wasserabscheider MS-LWS, Baureihe MS

FESTO

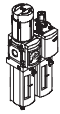
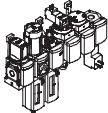
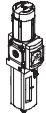
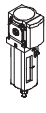
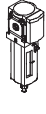
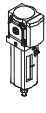

Wasserabscheider MS-LWS, Baureihe MS

Lieferübersicht Wartungsgeräte Baureihe MS

Typ	Bau- größe	Pneumatischer Anschluss im Gehäuse	Anschlussplatte	Druckregelbereich [bar]						Filterfeinheit [µm]			
				0,05 ...	0,05 ...	0,1 ...	0,3 ...	0,1 ...	0,5 ...	0,01	1	5	40
Code			AG...	D2	D4	D5	D6	D7	D8	A	B	C	E
Wartungseinheiten													
MSB-FRC 	4	G1/8, G1/4	G1/8, G1/4, G3/8	-	-	-	■	■	-	-	-	■	■
	6	G1/4, G3/8, G1/2	G1/4, G3/8, G1/2, G3/4	-	-	-	■	■	-	-	-	■	■
	9	-	-	-	-	-	-	-	-	-	-	-	-
	12	-	-	-	-	-	-	-	-	-	-	-	-
Wartungsgeräte-Kombinationen (weitere Varianten bestellbar über Konfigurator → Internet: msb4, msb6 oder msb9)													
MSB 	4	G1/4	G1/8, G1/4, G3/8	-	-	-	■	■	-	-	-	■	■
	6	G1/2	G1/4, G3/8, G1/2, G3/4	-	-	-	■	■	-	-	-	■	■
	9	-	-	-	-	-	-	-	-	-	-	-	-
	12	-	-	-	-	-	-	-	-	-	-	-	-
Einzelgeräte													
Filterregel- ventile MS-LFR 	4	G1/8, G1/4	G1/8, G1/4, G3/8	-	-	■	■	■	-	-	-	■	■
	6	G1/4, G3/8, G1/2	G1/4, G3/8, G1/2, G3/4	-	-	■	■	■	■	-	-	■	■
	9	-	-	-	-	-	-	-	-	-	-	-	-
	12	-	G1, G1 1/4, G1 1/2, G2	-	-	-	■	■	■	-	-	■	■
Filter MS-LF 	4	G1/8, G1/4	G1/8, G1/4, G3/8	-	-	-	-	-	-	-	-	■	■
	6	G1/4, G3/8, G1/2	G1/4, G3/8, G1/2, G3/4	-	-	-	-	-	-	-	-	■	■
	9	-	-	-	-	-	-	-	-	-	-	-	-
	12	-	G1, G1 1/4, G1 1/2, G2	-	-	-	-	-	-	-	-	■	■
Fein- und Feinstfilter MS-LFM 	4	G1/8, G1/4	G1/8, G1/4, G3/8	-	-	-	-	-	-	■	■	-	-
	6	G1/4, G3/8, G1/2	G1/4, G3/8, G1/2, G3/4	-	-	-	-	-	-	■	■	-	-
	9	G3/4, G1	G1/2, G3/4, G1, G1 1/4, G1 1/2	-	-	-	-	-	-	■	■	-	-
	12	-	G1, G1 1/4, G1 1/2, G2	-	-	-	-	-	-	■	■	-	-
Aktivkohle- filter MS-LFX 	4	G1/8, G1/4	G1/8, G1/4, G3/8	-	-	-	-	-	-	-	-	-	-
	6	G1/4, G3/8, G1/2	G1/4, G3/8, G1/2, G3/4	-	-	-	-	-	-	-	-	-	-
	9	G3/4, G1	G1/2, G3/4, G1, G1 1/4, G1 1/2	-	-	-	-	-	-	-	-	-	-
	12	-	G1, G1 1/4, G1 1/2, G2	-	-	-	-	-	-	-	-	-	-
Wasser- abscheider MS-LWS 	4	-	-	-	-	-	-	-	-	-	-	-	-
	6	G1/4, G3/8, G1/2	G1/4, G3/8, G1/2, G3/4	-	-	-	-	-	-	-	-	-	-
	9	-	-	-	-	-	-	-	-	-	-	-	-
	12	-	-	-	-	-	-	-	-	-	-	-	-

Wasserabscheider MS-LWS, Baureihe MS











Lieferübersicht Wartungsgeräte Baureihe MS

Typ	Bau- größe	Schalen- schutz		Kondensatablass				Druckanzeige					Abschließ- barkeit		Optionen		→ Seite/ Internet
		Kunststoffschutzkorb	Metallschutzkorb	manuell drehend	halbautomatisch	vollautomatisch	extern, vollautoma- tisch, elektrisch	Verschlussblende (ohne Manometer)	integriertes MS-Manometer	Adapter EN-Manometer G ¹ / ₈	Adapter EN-Manometer G ¹ / ₄	Drucksensor	Drehknopf mit Arre- tierung, mit Zubehör schließbar	Drehknopf mit inte- griertem Schloss	Schalldämpfer	Durchflussrichtung von rechts nach links	
Code		R	U	M	H	V	E...	VS	AG	A8	A4	AD...	AS	E11	S	Z	
Wartungseinheiten																	
MSB-FRC	4	■	-	■	-	■	-	-	■	-	-	-	■	-	-	■	msb4
	6	■	■	■	-	■	-	-	■	-	-	-	■	-	-	■	msb6
	9	-	-	-	-	-	-	-	-	-	-	-	-	-	-	-	-
	12	-	-	-	-	-	-	-	-	-	-	-	-	-	-	-	-
Wartungsgeräte-Kombinationen																	
MSB	4	■	■	■	-	■	-	-	■	-	-	-	■	-	-	■	msb4
	6	■	■	■	-	■	-	-	■	-	-	-	■	-	-	■	msb6
	9	-	-	-	-	-	-	-	-	-	-	-	-	-	-	-	-
	12	-	-	-	-	-	-	-	-	-	-	-	-	-	-	-	-
Einzelgeräte																	
Filterregel- ventile	4	■	■	■	■	■	-	■	■	■	■	■	■	■	-	■	ms4-lfr
	6	■	■	■	■	■	■	■	■	-	■	■	■	■	-	■	ms6-lfr
MS-LFR	9	-	-	-	-	-	-	-	-	-	-	-	-	-	-	-	-
	12	-	■	■	-	■	■	■	■	-	■	-	■	■	-	■	ms12-lfr
Filter MS-LF	4	■	■	■	■	■	-	-	-	-	-	-	-	-	-	■	ms4-lf
	6	■	■	■	■	■	■	-	-	-	-	-	-	-	-	■	ms6-lf
	9	-	-	-	-	-	-	-	-	-	-	-	-	-	-	-	-
	12	-	■	■	-	■	■	-	-	-	-	-	-	-	-	■	ms12-lf
Fein- und Feinstfilter MS-LFM	4	■	■	■	■	■	-	-	-	-	-	-	-	-	-	■	ms4-lfm
	6	■	■	■	■	■	■	-	-	-	-	-	-	-	-	■	ms6-lfm
	9	-	■	■	-	■	■	-	-	-	-	-	-	-	-	■	ms9-lfm
	12	-	■	■	-	■	■	-	-	-	-	-	-	-	-	■	ms12-lfm
Aktivkohle- filter MS-LFX	4	■	■	-	-	-	-	-	-	-	-	-	-	-	-	■	ms4-lfx
	6	■	■	-	-	-	-	-	-	-	-	-	-	-	-	■	ms6-lfx
	9	-	■	-	-	-	-	-	-	-	-	-	-	-	-	■	ms9-lfx
	12	-	■	-	-	-	-	-	-	-	-	-	-	-	-	■	ms12-lfx
Wasser- abscheider MS-LWS	4	-	-	-	-	-	-	-	-	-	-	-	-	-	-	-	-
	6	-	■	-	-	■	■	-	-	-	-	-	-	-	-	■	8
	9	-	-	-	-	-	-	-	-	-	-	-	-	-	-	-	-
	12	-	-	-	-	-	-	-	-	-	-	-	-	-	-	-	-

Wasserabscheider MS-LWS, Baureihe MS

Lieferübersicht Wartungsgeräte Baureihe MS

FESTO

Typ	Bau- größe	Pneumatischer Anschluss im Gehäuse	Anschlussplatte	Druckregelbereich [bar]						Versorgungsspannung				
				0,05 ... 0,7	0,05 ... 2,5	0,1 ... 4	0,3 ... 7	0,1 ... 12	0,5 ... 16	24 V DC, Anschluss- bild nach EN 175301	24 V DC, Anschluss- bild M12 nach DESINA	110 V AC, Anschluss- bild nach EN 175301	230 V AC, Anschluss- bild nach EN 175301	
Code			AG...	D2	D4	D5	D6	D7	D8	V24	V24P	V110	V230	
Einzelgeräte														
Druckregel- ventile MS-LR		4	G $\frac{1}{8}$, G $\frac{1}{4}$	G $\frac{1}{8}$, G $\frac{1}{4}$, G $\frac{3}{8}$	-	-	■	■	■	-	-	-	-	
		6	G $\frac{1}{4}$, G $\frac{3}{8}$, G $\frac{1}{2}$	G $\frac{1}{4}$, G $\frac{3}{8}$, G $\frac{1}{2}$, G $\frac{3}{4}$	-	-	■	■	■	■	-	-	-	-
		9	-											
		12	-	G1, G1 $\frac{1}{4}$, G1 $\frac{1}{2}$, G2	-	-	-	■	■	■	-	-	-	-
Druckregel- ventile MS-LRB		4	G $\frac{1}{4}$	G $\frac{1}{8}$, G $\frac{1}{4}$, G $\frac{3}{8}$	-	-	■	■	■	-	-	-	-	
		6	G $\frac{1}{2}$	G $\frac{1}{4}$, G $\frac{3}{8}$, G $\frac{1}{2}$, G $\frac{3}{4}$	-	-	■	■	■	■	-	-	-	-
		9	-											
		12	-											
Präzisions- Druckregel- ventile MS-LRP		4	-											
		6	G $\frac{1}{4}$, G $\frac{3}{8}$, G $\frac{1}{2}$	G $\frac{1}{4}$, G $\frac{3}{8}$, G $\frac{1}{2}$, G $\frac{3}{4}$	■	■	■	-	■	-	-	-	-	
		9	-											
		12	-											
Präzisions- Druckregel- ventile MS-LRPB		4	-											
		6	G $\frac{1}{2}$	G $\frac{1}{4}$, G $\frac{3}{8}$, G $\frac{1}{2}$, G $\frac{3}{4}$	■	■	■	-	■	-	-	-	-	
		9	-											
		12	-											
Elektrik-Druck- regelventile MS-LRE		4	-											
		6	G $\frac{1}{4}$, G $\frac{3}{8}$, G $\frac{1}{2}$	G $\frac{1}{4}$, G $\frac{3}{8}$, G $\frac{1}{2}$, G $\frac{3}{4}$	-	-	■	■	■	■	-	-	-	
		9	-											
		12	-											
Öler MS-LOE		4	G $\frac{1}{8}$, G $\frac{1}{4}$	G $\frac{1}{8}$, G $\frac{1}{4}$, G $\frac{3}{8}$	-	-	-	-	-	-	-	-	-	
		6	G $\frac{1}{4}$, G $\frac{3}{8}$, G $\frac{1}{2}$	G $\frac{1}{4}$, G $\frac{3}{8}$, G $\frac{1}{2}$, G $\frac{3}{4}$	-	-	-	-	-	-	-	-	-	
		9	-											
		12	-	G1, G1 $\frac{1}{4}$, G1 $\frac{1}{2}$, G2	-	-	-	-	-	-	-	-	-	-
Einschalt- ventile MS-EM(1)		4	G $\frac{1}{8}$, G $\frac{1}{4}$	G $\frac{1}{8}$, G $\frac{1}{4}$, G $\frac{3}{8}$	-	-	-	-	-	-	-	-	-	
		6	G $\frac{1}{4}$, G $\frac{3}{8}$, G $\frac{1}{2}$	G $\frac{1}{4}$, G $\frac{3}{8}$, G $\frac{1}{2}$, G $\frac{3}{4}$	-	-	-	-	-	-	-	-	-	
		9	-											
		12	-	G1, G1 $\frac{1}{4}$, G1 $\frac{1}{2}$, G2	-	-	-	-	-	-	-	-	-	-
Einschalt- ventile MS-EE		4	G $\frac{1}{8}$, G $\frac{1}{4}$	G $\frac{1}{8}$, G $\frac{1}{4}$, G $\frac{3}{8}$	-	-	-	-	-	■	-	■	■	
		6	G $\frac{1}{4}$, G $\frac{3}{8}$, G $\frac{1}{2}$	G $\frac{1}{4}$, G $\frac{3}{8}$, G $\frac{1}{2}$, G $\frac{3}{4}$	-	-	-	-	-	■	-	■	■	
		9	-											
		12	-	G1, G1 $\frac{1}{4}$, G1 $\frac{1}{2}$, G2	-	-	-	-	-	-	■	■	■	■
Druckaufbau- ventile MS-DL		4	G $\frac{1}{8}$, G $\frac{1}{4}$	G $\frac{1}{8}$, G $\frac{1}{4}$, G $\frac{3}{8}$	-	-	-	-	-	-	-	-	-	
		6	G $\frac{1}{4}$, G $\frac{3}{8}$, G $\frac{1}{2}$	G $\frac{1}{4}$, G $\frac{3}{8}$, G $\frac{1}{2}$, G $\frac{3}{4}$	-	-	-	-	-	-	-	-	-	
		9	-											
		12	-	G1, G1 $\frac{1}{4}$, G1 $\frac{1}{2}$, G2	-	-	-	-	-	-	-	-	-	-
Druckaufbau- ventile MS-DE		4	G $\frac{1}{8}$, G $\frac{1}{4}$	G $\frac{1}{8}$, G $\frac{1}{4}$, G $\frac{3}{8}$	-	-	-	-	-	■	-	■	■	
		6	G $\frac{1}{4}$, G $\frac{3}{8}$, G $\frac{1}{2}$	G $\frac{1}{4}$, G $\frac{3}{8}$, G $\frac{1}{2}$, G $\frac{3}{4}$	-	-	-	-	-	■	-	■	■	
		9	-											
		12	-	G1, G1 $\frac{1}{4}$, G1 $\frac{1}{2}$, G2	-	-	-	-	-	-	■	■	■	■
Druckaufbau- und Entlüf- tungsventile MS-SV		4	-											
		6	G $\frac{1}{2}$	G $\frac{1}{4}$, G $\frac{3}{8}$, G $\frac{1}{2}$, G $\frac{3}{4}$	-	-	-	-	-	-	■	-	-	
		9	-											
		12	-											

Wasserabscheider MS-LWS, Baureihe MS





Lieferübersicht Wartungsgeräte Baureihe MS



Typ	Bau- größe	Schalenschutz		Druckanzeige				Abschließbar- keit		Optionen		→ Seite/ Internet	
		Kunststoffschutzkorb	Metallschutzkorb	Verschlussblende (ohne Manometer)	integriertes MS-Manometer	Adapter EN-Manometer G $\frac{1}{8}$	Adapter EN-Manometer G $\frac{1}{4}$	Drucksensor	Drehknopf mit Arre- tierung, mit Zubehör schließbar	Drehknopf mit inte- griertem Schloss	Schalldämpfer		Durchflussrichtung von rechts nach links
Code		R	U	VS	AG	A8	A4	AD...	AS	E11	S	Z	
Einzelgeräte													
Druckregel- ventile MS-LR	4	-	-	■	■	■	■	■	■	■	-	■	ms4-lr
	6	-	-	■	■	-	■	■	■	■	-	■	ms6-lr
	9	-	-	-	-	-	-	-	-	-	-	-	-
	12	-	-	■	■	-	■	-	■	■	-	■	ms12-lr
Druckregel- ventile MS-LRB	4	-	-	■	■	■	■	■	■	■	-	■	ms4-lrb
	6	-	-	■	■	-	■	■	■	■	-	■	ms6-lrb
	9	-	-	-	-	-	-	-	-	-	-	-	-
	12	-	-	-	-	-	-	-	-	-	-	-	-
Präzisions- Druckregel- ventile MS-LRP	4	-	-	-	-	-	-	-	-	-	-	-	-
	6	-	-	■	-	■	■	■	■	■	-	■	ms6-lrp
	9	-	-	-	-	-	-	-	-	-	-	-	-
	12	-	-	-	-	-	-	-	-	-	-	-	-
Präzisions- Druckregel- ventile MS-LRPB	4	-	-	-	-	-	-	-	-	-	-	-	-
	6	-	-	■	-	■	■	■	■	■	-	■	ms6-lrpb
	9	-	-	-	-	-	-	-	-	-	-	-	-
	12	-	-	-	-	-	-	-	-	-	-	-	-
Elektrik-Druck- regelventile MS-LRE	4	-	-	-	-	-	-	-	-	-	-	-	-
	6	-	-	■	■	-	■	-	-	-	-	■	ms6-lre
	9	-	-	-	-	-	-	-	-	-	-	-	-
	12	-	-	-	-	-	-	-	-	-	-	-	-
Öler MS-LOE	4	■	■	-	-	-	-	-	-	-	-	■	ms4-loe
	6	■	■	-	-	-	-	-	-	-	-	■	ms6-loe
	9	-	-	-	-	-	-	-	-	-	-	-	-
	12	-	■	-	-	-	-	-	-	-	-	■	ms12-loe
Einschalt- ventile MS-EM(1)	4	-	-	■	■	■	■	■	-	-	■	■	ms4-em1
	6	-	-	■	■	-	■	■	-	-	■	■	ms6-em1
	9	-	-	-	-	-	-	-	-	-	-	-	-
	12	-	-	■	■	-	■	-	-	-	■	■	ms12-em
Einschalt- ventile MS-EE	4	-	-	■	■	■	■	■	-	-	■	■	ms4-ee
	6	-	-	■	■	-	■	■	-	-	■	■	ms6-ee
	9	-	-	-	-	-	-	-	-	-	-	-	-
	12	-	-	■	■	-	■	-	-	-	■	■	ms12-ee
Druckaufbau- ventile MS-DL	4	-	-	■	■	■	■	■	-	-	-	■	ms4-dl
	6	-	-	■	■	-	■	■	-	-	-	■	ms6-dl
	9	-	-	-	-	-	-	-	-	-	-	-	-
	12	-	-	■	■	-	■	-	-	-	-	■	ms12-dl
Druckaufbau- ventile MS-DE	4	-	-	■	■	■	■	■	-	-	-	■	ms4-de
	6	-	-	■	■	-	■	■	-	-	-	■	ms6-de
	9	-	-	-	-	-	-	-	-	-	-	-	-
	12	-	-	■	■	-	■	-	-	-	-	■	ms12-de
Druckaufbau- und Entlüf- tungsventile MS-SV	4	-	-	-	-	-	-	-	-	-	-	-	-
	6	-	-	■	■	-	■	■	-	-	■	■	ms6-sv
	9	-	-	-	-	-	-	-	-	-	-	-	-
	12	-	-	-	-	-	-	-	-	-	-	-	-

Wasserabscheider MS-LWS, Baureihe MS

Lieferübersicht Wartungsgeräte Baureihe MS

Typ	Bau- größe	Pneumatischer Anschluss im Gehäuse	Anschlussplatte	Druckregelbereich [bar]				Versorgungsspannung			
				0,1 ... 4	0,3 ... 7	0,1 ... 12	0,5 ... 16	24 V DC, Anschluss- bild nach EN 175301	24 V DC, Anschluss- bild M12 nach DESINA	110 V AC, Anschluss- bild nach EN 175301	230 V AC, Anschluss- bild nach EN 175301
Code			AG...	D5	D6	D7	D8	V24	V24P	V110	V230
Einzelgeräte											
Membran- Lufttrockner MS-LDM1		4	G1/8, G1/4	G1/8, G1/4, G3/8	-	-	-	-	-	-	-
		6	G1/4, G3/8, G1/2	G1/4, G3/8, G1/2, G3/4	-	-	-	-	-	-	-
		9	-	-	-	-	-	-	-	-	-
		12	-	-	-	-	-	-	-	-	-
Abzweig- module MS-FRM		4	G1/8, G1/4	G1/8, G1/4, G3/8	-	-	-	-	-	-	-
		6	G1/4, G3/8, G1/2	G1/4, G3/8, G1/2, G3/4	-	-	-	-	-	-	-
		9	-	-	-	-	-	-	-	-	-
		12	-	G1, G1 1/4, G1 1/2, G2	-	-	-	-	-	-	-
Verteiler- blöcke MS-FRM-FRZ		4	G1/4	-	-	-	-	-	-	-	-
		6	G1/2	-	-	-	-	-	-	-	-
		9	-	-	-	-	-	-	-	-	-
		12	-	-	-	-	-	-	-	-	-
Durchfluss- sensoren MS-SFE		4	-	-	-	-	-	-	-	-	-
		6	G1/2	G1/2	-	-	-	-	-	-	-
		9	-	-	-	-	-	-	-	-	-
		12	-	-	-	-	-	-	-	-	-
Durchfluss- sensoren SFAM		4	-	-	-	-	-	-	-	-	-
		6	G1/2	G1/2	-	-	-	-	-	-	-
		9	-	-	-	-	-	-	-	-	-
		12	-	-	-	-	-	-	-	-	-

Wasserabscheider MS-LWS, Baureihe MS

Lieferübersicht Wartungsgeräte Baureihe MS

Typ	Bau- größe	Schalenschutz		Druckanzeige				Schaltausgang		Optionen		→ Seite/ Internet	
		Kunststoffschutzkorb	Metallschutzkorb	Verschussblende (ohne Manometer)	integriertes MS-Manometer	Adapter EN-Manometer G½	Adapter EN-Manometer G¼	Drucksensor	2x PNP	2x NPN	Schalldämpfer		Durchflussrichtung von rechts nach links
Code		R	U	VS	AG	A8	A4	AD...	P2/2S	N2/2S	S	Z/R	
Einzelgeräte													
Membran- Lufttrockner MS-LDM1	4	-	■	-	-	-	-	-	-	-	-	■	ms4-ldm1
	6	-	■	-	-	-	-	-	-	-	-	■	ms6-ldm1
	9	-	-	-	-	-	-	-	-	-	-	-	-
	12	-	-	-	-	-	-	-	-	-	-	-	-
Abzweig- module MS-FRM	4	-	-	■	■	■	■	■	-	-	-	■	ms4-frm
	6	-	-	■	■	-	■	■	-	-	-	■	ms6-frm
	9	-	-	-	-	-	-	-	-	-	-	-	-
	12	-	-	■	-	-	-	-	-	-	-	-	ms12-frm
Verteiler- blöcke MS-FRM-FRZ	4	-	-	-	-	-	-	-	-	-	-	■	ms4-frm
	6	-	-	-	-	-	-	-	-	-	-	■	ms6-frm
	9	-	-	-	-	-	-	-	-	-	-	-	-
	12	-	-	-	-	-	-	-	-	-	-	-	-
Durchfluss- sensoren MS-SFE	4	-	-	-	-	-	-	-	■	■	-	■ ¹⁾	ms6-sfe
	6	-	-	-	-	-	-	-	■	■	-	■ ¹⁾	ms6-sfe
	9	-	-	-	-	-	-	-	-	-	-	-	-
	12	-	-	-	-	-	-	-	-	-	-	-	-
Durchfluss- sensoren SFAM	4	-	-	-	-	-	-	-	■	■	-	■	sfam
	6	-	-	-	-	-	-	-	■	■	-	■	sfam
	9	-	-	-	-	-	-	-	-	-	-	-	-
	12	-	-	-	-	-	-	-	-	-	-	-	-

1) Nur über Konfigurator bestellbar → Internet: ms6-sfe

Wasserabscheider MS6-LWS, Baureihe MS

Peripherieübersicht

Wasserabscheider MS6-LWS

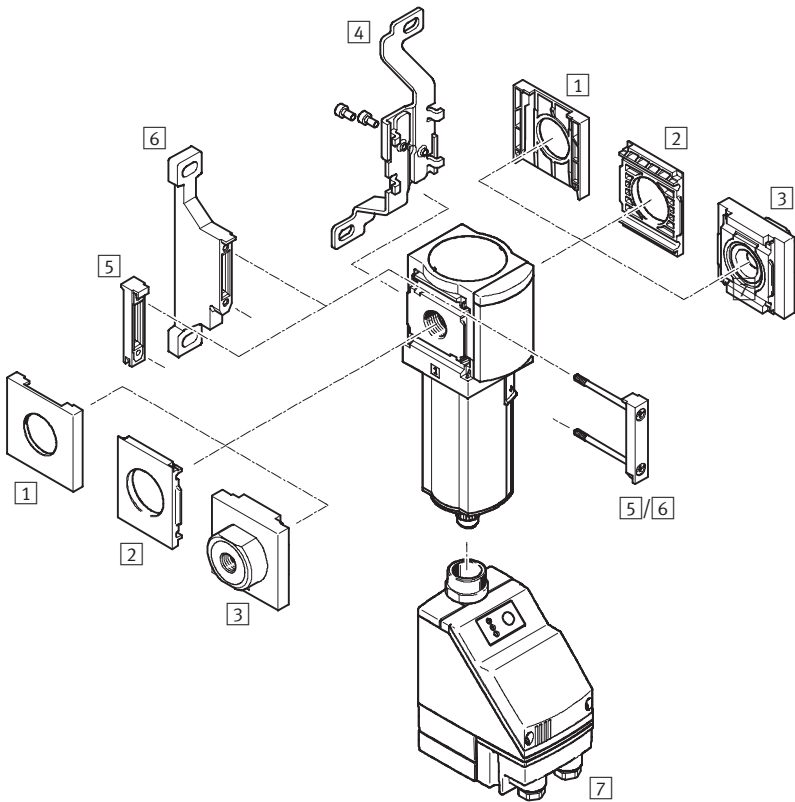

 Hinweis

Weiteres Zubehör:

- Modulverbinder für Kombination mit Baugröße MS4/MS6 oder Baugröße MS9 → Internet: amv, rmv, armv
- Adapter für Montage an Profile → Internet: ipm-80, ipm-40-80, ipm-80-80

Befestigungselemente und Zubehör

	Einzelgerät		Kombination		→ Seite/Internet
	ohne Anschlussplatte	mit Anschlussplatte	ohne Anschlussplatte	mit Anschlussplatte	
1 Abdeckkappe MS6-END	■	-	■	-	ms6-end
2 Befestigungsplatte MS6-AEND	■ ¹⁾	-	■ ¹⁾	-	ms6-aend
3 Anschlussplatte MS6-AG...	-	■ ¹⁾	-	■ ¹⁾	ms6-ag
4 Befestigungswinkel MS6-WB	■	■	-	-	ms6-wb
5 Modulverbinder MS6-MV	-	■	■	■	ms6-mv
6 Befestigungswinkel MS6-WP	■	■	■	■	ms6-wp
Befestigungswinkel (ohne Abbildung) MS6-WPB/WPE/WPM	■	■	■	■	ms6-wp
7 Kondensatablass vollautomatisch, elektrisch gesteuert E1 ... E4	■	■	■	■	13

1) Zur Montage wird Modulverbinder MS6-MV [5] oder Befestigungswinkel MS6-WP/WPB/WPE/WPM [6] benötigt.

Wasserabscheider MS6-LWS, Baureihe MS

Typenschlüssel

		MS	6	-	LWS	-	1/4	-	U	-	V
Baureihe											
MS	Wartungseinheit Standard										
Baugröße											
6	Rastermaß 62 mm										
Wartungsfunktion											
LWS	Wasserabscheider										
Pneumatischer Anschluss											
1/4	Gewinde G1/4										
3/8	Gewinde G3/8										
1/2	Gewinde G1/2										
Schalenschutz											
U	Metallschutzkorb										
Kondensatablass											
V	vollautomatisch										

Weitere Varianten können Sie über den Produktbaukasten bestellen → 13



- Anschlussplatten
- Kondensatablass
- Befestigungsart
- Alternative Durchflussrichtung

Wasserabscheider MS6-LWS, Baureihe MS

Datenblatt

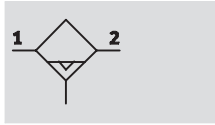
Funktion
Kondensatablass
vollautomatisch



-  - Durchfluss
2 400 ... 3 800 l/min
-  - Temperaturbereich
+1 ... +60 °C
-  - Eingangsdruck
0,8 ... 16 bar



Der wartungsfreie Wasserabscheider befreit die Druckluft von Kondenswasser.

- Konstant hohe Kondensatabscheidung (99 %) bis zum maximalen Durchfluss
- Metallschutzkorb
- Wahlweise mit vollautomatischem oder vollautomatischem, elektrisch gesteuertem Kondensatablass

Allgemeine Technische Daten				
Baugröße	MS6			
Pneumatischer Anschluss 1, 2	G $\frac{1}{4}$	G $\frac{3}{8}$	G $\frac{1}{2}$	G $\frac{1}{4}$... G $\frac{3}{4}$ (mit Anschlussplatte AG...)
Konstruktiver Aufbau	Zentrifugalabscheider			
Befestigungsart	mit Zubehör Leitungseinbau			
Einbaulage	senkrecht $\pm 5^\circ$			
Luftreinheitsklasse am Ausgang	-7.- nach DIN ISO 8573-1			
Schalenschutz	Metallschutzkorb			
Kondensatablass	vollautomatisch vollautomatisch, elektrisch gesteuert			
Kondensatabscheidegrad [%]	99			
Max. Kondensatmenge [ml]	38			

• Hinweis: Dieses Produkt entspricht ISO 1179-1 und ISO 228-1.

Normalnendurchfluss qnN ¹⁾			
Baugröße	MS6		
Pneumatischer Anschluss	G $\frac{1}{4}$	G $\frac{3}{8}$	G $\frac{1}{2}$
qnN [l/min]	2 400	3 500	3 800

1) Gemessen bei p₁ = 6 bar und Δp = 1 bar

Betriebs- und Umweltbedingungen		
Kondensatablass	vollautomatisch V	vollautomatisch, elektrisch gesteuert E1 ... E4
Baugröße	MS6	
Eingangsdruck [bar]	2 ... 12	0,8 ... 16
Betriebsmedium	Druckluft	
Umgebungstemperatur [°C]	+5 ... +60	+1 ... +60
Mediumtemperatur [°C]	+5 ... +60	+1 ... +60
Lagertemperatur [°C]	-10 ... +60	+1 ... +60
Korrosionsbeständigkeit KBK ¹⁾	2	

1) Korrosionsbeständigkeitsklasse 2 nach Festo Norm 940 070
Bauteile mit mäßiger Korrosionsbeanspruchung. Außenliegende sichtbare Teile mit vorrangig dekorativer Anforderung an die Oberfläche, die im direkten Kontakt zur umgebenden industriellen Atmosphäre bzw. Medien, wie Kühl- und Schmierstoffe stehen.

Wasserabscheider MS6-LWS, Baureihe MS

FESTO

Datenblatt

Gewichte [g]	
Baugröße	MS6
Wasserabscheider	820
Wasserabscheider mit Kondensatablass vollautomatisch, elektrisch gesteuert E1 ... E4	1 800

Werkstoffe

Funktionschnitt

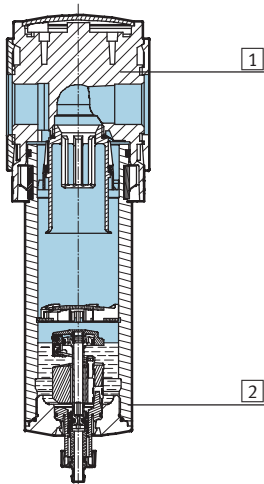

Wasserabscheider		
1	Gehäuse	Aluminium-Druckguss
2	Schale	Aluminium-Knetlegierung
	Sichtscheibe	Polyamid
-	Dichtungen	Nitrilkautschuk
Werkstoff-Hinweis		Kupfer- und PTFE-frei
		RoHS konform (nicht mit Variante E1, E2, E3 oder E4)

Normaldurchfluss qn in Abhängigkeit vom Differenzdruck p1-2

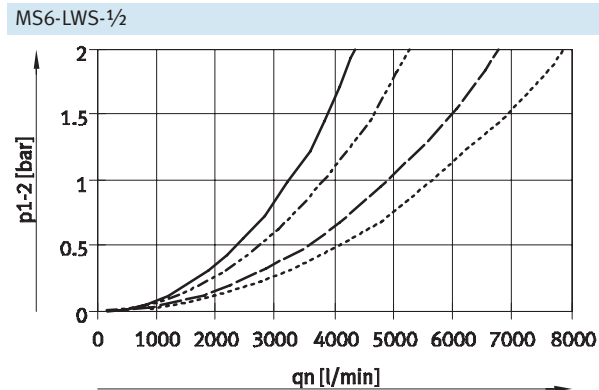
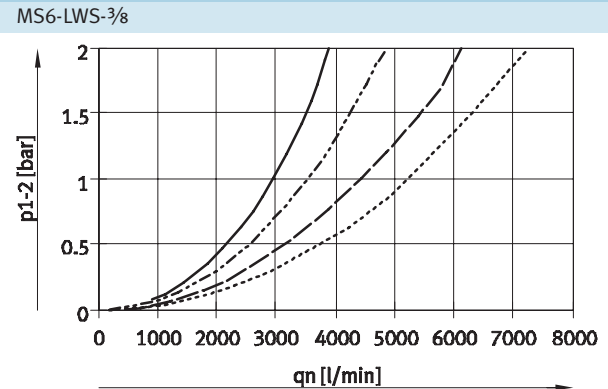
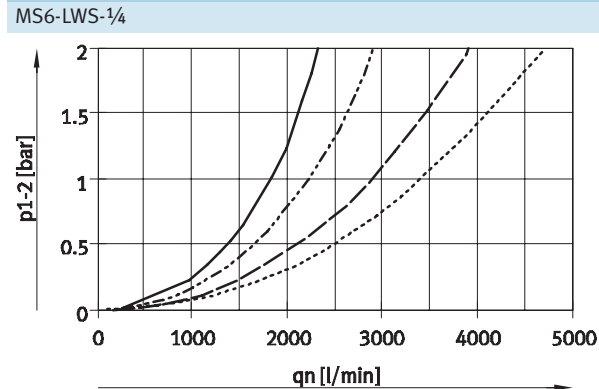

- 4 bar
- - - 6 bar
- · — 10 bar
- · - · - 14 bar

Wasserabscheider MS6-LWS, Baureihe MS

Datenblatt

Abmessungen – Standard

Download CAD-Daten → www.festo.com

Kondensatablass vollautomatisch V

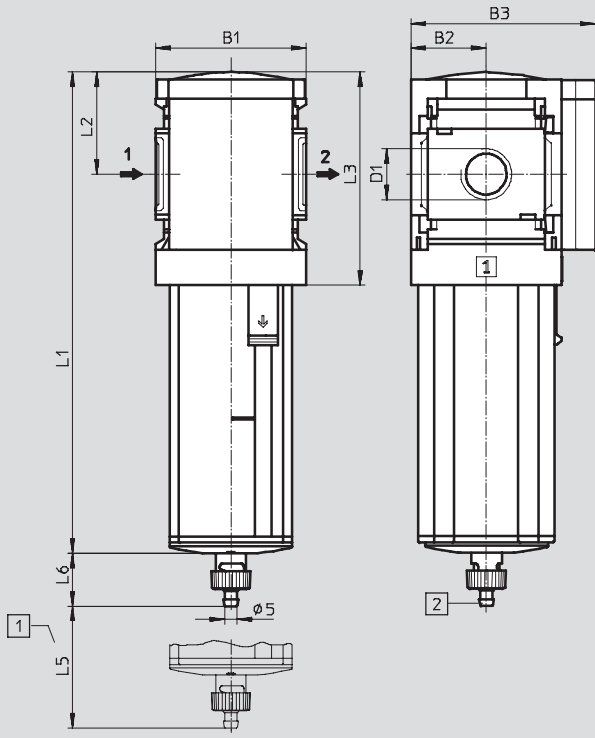

- 1 Einbaumaß
- 2 Stecknippel für Kunststoffschlauch PCN-4

→ Durchflussrichtung

Typ	B1	B2	B3	D1	L1	L2	L3	L5	L6
MS6-LWS-1/4-...-V	62	31	76	G1/4	198	42	87	68	22
MS6-LWS-3/8-...-V				G3/8					
MS6-LWS-1/2-...-V				G1/2					

⚠ Hinweis: Dieses Produkt entspricht ISO 1179-1 und ISO 228-1.

Abmessungen – Kondensatablass

Download CAD-Daten → www.festo.com

vollautomatisch, elektrisch gesteuert E1 ... E4

Datenblätter → Internet: pwea

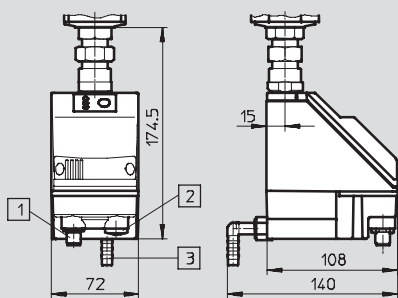

- 1 Variante E1:
Kondensatablass PWEA-AP mit M12x1 Stecker, 5-polig für NEBU-M12...-LE5
- 2 Variante E2/E3/E4:
Kondensatablass PWEA-AC mit Kabelverschraubung Pg9
- 3 Anschluss 360° schwenkbar für Kunststoffschlauch PUN-H-12x2

Bestellangaben

Baugröße	Kondensatablass	Anschluss	Teile-Nr.	Typ
Metallschutzkorb				
MS6	vollautomatisch	G1/4	564868	MS6-LWS-1/4-U-V
		G3/8	564869	MS6-LWS-3/8-U-V
		G1/2	564870	MS6-LWS-1/2-U-V

Wasserabscheider MS6-LWS, Baureihe MS

FESTO

Bestellangaben – Produktbaukasten

M Mindestangaben							O Optionen	
Baukasten-Nr.	Bau-reihe	Bau-größe	Funktion	Anschluss-größe	Schalenschutz	Kondensatablass	Befestigungsart	Alternative Durchflussrichtung
564858	MS	6	LWS	1/4, 3/8, 1/2, AGB, AGC, AGD, AGE	U	V E1 E2 E3 E4	WP WPM WB	Z
Bestellbeispiel								
564858	MS	6	-LWS	-AGB	-U	-V	-WP	-Z

Bestelltabelle		Bedingungen	Code	Eintrag Code
Rastermaß	[mm]	62		
M Baukasten-Nr.	564858			
Baureihe	Standard		MS	MS
Baugröße	6		6	6
Funktion	Wasserabscheider		-LWS	-LWS
Anschlussgröße	Gewinde G1/4		-1/4	
	Gewinde G3/8		-3/8	
	Gewinde G1/2		-1/2	
	Anschlussplatte G1/4		-AGB	
	Anschlussplatte G3/8		-AGC	
	Anschlussplatte G1/2		-AGD	
	Anschlussplatte G3/4		-AGE	
Schalenschutz	Metallschutzkorb		-U	-U
Kondensatablass	vollautomatisch (P1 max. 12 bar)		-V	
	externer vollautomatischer Kondensatablass, elektrisch, 24 V DC, M12 (P1 max. 16 bar)		-E1	
	externer vollautomatischer Kondensatablass, elektrisch, 110 V AC, Anschlussklemmen (P1 max. 16 bar)		-E2	
	externer vollautomatischer Kondensatablass, elektrisch, 230 V AC, Anschlussklemmen (P1 max. 16 bar)		-E3	
	externer vollautomatischer Kondensatablass, elektrisch, 24 V DC, Anschlussklemmen (P1 max. 16 bar)		-E4	
O Befestigungsart	Befestigungswinkel	1	-WP	
	Befestigungswinkel	1	-WPM	
	Befestigungswinkel		-WB	
Alternative Durchflussrichtung	Durchflussrichtung von rechts nach links		-Z	

1 WP, WPM Nur mit Anschlussplatte AGB, AGC, AGD oder AGE

Übertrag Bestellcode

	MS	6	-LWS		-U			
--	-----------	----------	-------------	--	-----------	--	--	--