

# Membran-Lufttrockner MS-LDM1, Baureihe MS







**FESTO**

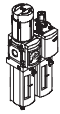
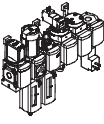

# Membran-Lufttrockner MS-LDM1, Baureihe MS

FESTO

Lieferübersicht Wartungsgeräte Baureihe MS

Typ	Bau- größe	Pneumatischer Anschluss im Gehäuse	Anschlussplatte	Druckregelbereich [bar]						Filterfeinheit [µm]			
				0,05 ... 0,7	0,05 ... 2,5	0,1 ... 4	0,3 ... 7	0,1 ... 12	0,5 ... 16	0,01	1	5	40
Code			AG...	D2	D4	D5	D6	D7	D8	A	B	C	E
<b>Wartungseinheiten</b>													
<b>MSB-FRC</b> 	4	G <sup>1</sup> / <sub>8</sub> , G <sup>1</sup> / <sub>4</sub>	G <sup>1</sup> / <sub>8</sub> , G <sup>1</sup> / <sub>4</sub> , G <sup>3</sup> / <sub>8</sub>	-	-	-	■	■	-	-	-	■	■
	6	G <sup>1</sup> / <sub>4</sub> , G <sup>3</sup> / <sub>8</sub> , G <sup>1</sup> / <sub>2</sub>	G <sup>1</sup> / <sub>4</sub> , G <sup>3</sup> / <sub>8</sub> , G <sup>1</sup> / <sub>2</sub> , G <sup>3</sup> / <sub>4</sub>	-	-	-	■	■	-	-	-	■	■
	9	-	-	-	-	-	-	-	-	-	-	-	-
	12	-	-	-	-	-	-	-	-	-	-	-	-
<b>Wartungsgeräte-Kombinationen (weitere Varianten bestellbar über Konfigurator → Internet: msb4, msb6 oder msb9)</b>													
<b>MSB</b> 	4	G <sup>1</sup> / <sub>4</sub>	G <sup>1</sup> / <sub>8</sub> , G <sup>1</sup> / <sub>4</sub> , G <sup>3</sup> / <sub>8</sub>	-	-	-	■	■	-	-	-	■	■
	6	G <sup>1</sup> / <sub>2</sub>	G <sup>1</sup> / <sub>4</sub> , G <sup>3</sup> / <sub>8</sub> , G <sup>1</sup> / <sub>2</sub> , G <sup>3</sup> / <sub>4</sub>	-	-	-	■	■	-	-	-	■	■
	9	-	-	-	-	-	-	-	-	-	-	-	-
	12	-	-	-	-	-	-	-	-	-	-	-	-
<b>Einzelgeräte</b>													
Filterregel- ventile <b>MS-LFR</b> 	4	G <sup>1</sup> / <sub>8</sub> , G <sup>1</sup> / <sub>4</sub>	G <sup>1</sup> / <sub>8</sub> , G <sup>1</sup> / <sub>4</sub> , G <sup>3</sup> / <sub>8</sub>	-	-	■	■	■	-	-	-	■	■
	6	G <sup>1</sup> / <sub>4</sub> , G <sup>3</sup> / <sub>8</sub> , G <sup>1</sup> / <sub>2</sub>	G <sup>1</sup> / <sub>4</sub> , G <sup>3</sup> / <sub>8</sub> , G <sup>1</sup> / <sub>2</sub> , G <sup>3</sup> / <sub>4</sub>	-	-	■	■	■	■	-	-	■	■
	9	-	-	-	-	-	-	-	-	-	-	-	-
	12	-	G1, G1 <sup>1</sup> / <sub>4</sub> , G1 <sup>1</sup> / <sub>2</sub> , G2	-	-	-	■	■	■	-	-	■	■
Filter <b>MS-LF</b> 	4	G <sup>1</sup> / <sub>8</sub> , G <sup>1</sup> / <sub>4</sub>	G <sup>1</sup> / <sub>8</sub> , G <sup>1</sup> / <sub>4</sub> , G <sup>3</sup> / <sub>8</sub>	-	-	-	-	-	-	-	-	■	■
	6	G <sup>1</sup> / <sub>4</sub> , G <sup>3</sup> / <sub>8</sub> , G <sup>1</sup> / <sub>2</sub>	G <sup>1</sup> / <sub>4</sub> , G <sup>3</sup> / <sub>8</sub> , G <sup>1</sup> / <sub>2</sub> , G <sup>3</sup> / <sub>4</sub>	-	-	-	-	-	-	-	-	■	■
	9	-	-	-	-	-	-	-	-	-	-	-	-
	12	-	G1, G1 <sup>1</sup> / <sub>4</sub> , G1 <sup>1</sup> / <sub>2</sub> , G2	-	-	-	-	-	-	-	-	■	■
Fein- und Feinstfilter <b>MS-LFM</b> 	4	G <sup>1</sup> / <sub>8</sub> , G <sup>1</sup> / <sub>4</sub>	G <sup>1</sup> / <sub>8</sub> , G <sup>1</sup> / <sub>4</sub> , G <sup>3</sup> / <sub>8</sub>	-	-	-	-	-	-	■	■	-	-
	6	G <sup>1</sup> / <sub>4</sub> , G <sup>3</sup> / <sub>8</sub> , G <sup>1</sup> / <sub>2</sub>	G <sup>1</sup> / <sub>4</sub> , G <sup>3</sup> / <sub>8</sub> , G <sup>1</sup> / <sub>2</sub> , G <sup>3</sup> / <sub>4</sub>	-	-	-	-	-	-	■	■	-	-
	9	G <sup>3</sup> / <sub>4</sub> , G1	G <sup>1</sup> / <sub>2</sub> , G <sup>3</sup> / <sub>4</sub> , G1, G1 <sup>1</sup> / <sub>4</sub> , G1 <sup>1</sup> / <sub>2</sub>	-	-	-	-	-	-	■	■	-	-
	12	-	G1, G1 <sup>1</sup> / <sub>4</sub> , G1 <sup>1</sup> / <sub>2</sub> , G2	-	-	-	-	-	-	■	■	-	-
Aktivkohle- filter <b>MS-LFX</b> 	4	G <sup>1</sup> / <sub>8</sub> , G <sup>1</sup> / <sub>4</sub>	G <sup>1</sup> / <sub>8</sub> , G <sup>1</sup> / <sub>4</sub> , G <sup>3</sup> / <sub>8</sub>	-	-	-	-	-	-	-	-	-	-
	6	G <sup>1</sup> / <sub>4</sub> , G <sup>3</sup> / <sub>8</sub> , G <sup>1</sup> / <sub>2</sub>	G <sup>1</sup> / <sub>4</sub> , G <sup>3</sup> / <sub>8</sub> , G <sup>1</sup> / <sub>2</sub> , G <sup>3</sup> / <sub>4</sub>	-	-	-	-	-	-	-	-	-	-
	9	G <sup>3</sup> / <sub>4</sub> , G1	G <sup>1</sup> / <sub>2</sub> , G <sup>3</sup> / <sub>4</sub> , G1, G1 <sup>1</sup> / <sub>4</sub> , G1 <sup>1</sup> / <sub>2</sub>	-	-	-	-	-	-	-	-	-	-
	12	-	G1, G1 <sup>1</sup> / <sub>4</sub> , G1 <sup>1</sup> / <sub>2</sub> , G2	-	-	-	-	-	-	-	-	-	-
Wasser- abscheider <b>MS-LWS</b> 	4	-	-	-	-	-	-	-	-	-	-	-	-
	6	G <sup>1</sup> / <sub>4</sub> , G <sup>3</sup> / <sub>8</sub> , G <sup>1</sup> / <sub>2</sub>	G <sup>1</sup> / <sub>4</sub> , G <sup>3</sup> / <sub>8</sub> , G <sup>1</sup> / <sub>2</sub> , G <sup>3</sup> / <sub>4</sub>	-	-	-	-	-	-	-	-	-	-
	9	-	-	-	-	-	-	-	-	-	-	-	-
	12	-	-	-	-	-	-	-	-	-	-	-	-

# Membran-Lufttrockner MS-LDM1, Baureihe MS



Lieferübersicht Wartungsgeräte Baureihe MS

Typ	Bau- größe	Schalen- schutz		Kondensatablass				Druckanzeige				Betätigungs- sicherung		Optionen		→ Seite/ Internet	
		Kunststoffschutzkorb	Metallschale	manuell drehend	halbautomatisch	vollautomatisch	extern, vollautoma- tisch, elektrisch	Verschlussblende (ohne Manometer)	integriertes MS-Manometer	Adapter EN-Manometer G <sup>1</sup> / <sub>8</sub>	Adapter EN-Manometer G <sup>1</sup> / <sub>4</sub>	Drucksensor	Drehknopf, abschließbar	Drehknopf, lang	Schalldämpfer		Durchflussrichtung von rechts nach links
Code		R	U	M	H	V	E...	VS	AG	A8	A4	AD...	AS	LD	S	Z	
<b>Wartungseinheiten</b>																	
<b>MSB-FRC</b>	4	■	-	■	-	■	-	-	■	-	-	-	■	-	-	■	msb4
	6	■	■	■	-	■	-	-	■	-	-	-	■	-	-	■	msb6
	9	-	-	-	-	-	-	-	-	-	-	-	-	-	-	-	-
	12	-	-	-	-	-	-	-	-	-	-	-	-	-	-	-	-
<b>Wartungsgeräte-Kombinationen</b>																	
<b>MSB</b>	4	■	■	■	-	■	-	-	■	-	-	-	■	-	-	■	msb4
	6	■	■	■	-	■	-	-	■	-	-	-	■	-	-	■	msb6
	9	-	-	-	-	-	-	-	-	-	-	-	-	-	-	-	-
	12	-	-	-	-	-	-	-	-	-	-	-	-	-	-	-	-
<b>Einzelgeräte</b>																	
Filterregel- ventile <b>MS-LFR</b>	4	■	■	■	■	■	-	■	■	■	■	■	■	■	-	■	ms4-lfr
	6	■	■	■	■	■	■	■	■	-	■	■	■	■	-	■	ms6-lfr
	9	-	-	-	-	-	-	-	-	-	-	-	-	-	-	-	-
	12	-	■	■	-	■	■	■	■	-	■	-	■	■	-	■	ms12-lfr
Filter <b>MS-LF</b>	4	■	■	■	■	■	-	-	-	-	-	-	-	-	-	■	ms4-lf
	6	■	■	■	■	■	■	-	-	-	-	-	-	-	-	■	ms6-lf
	9	-	-	-	-	-	-	-	-	-	-	-	-	-	-	-	-
	12	-	■	■	-	■	■	-	-	-	-	-	-	-	-	■	ms12-lf
Fein- und Feinstfilter <b>MS-LFM</b>	4	■	■	■	■	■	-	-	-	-	-	-	-	-	-	■	ms4-lfm
	6	■	■	■	■	■	■	-	-	-	-	-	-	-	-	■	ms6-lfm
	9	-	■	■	-	■	■	-	-	-	-	-	-	-	-	■	ms9-lfm
	12	-	■	■	-	■	■	-	-	-	-	-	-	-	-	■	ms12-lfm
Aktivkohle- filter <b>MS-LFX</b>	4	■	■	-	-	-	-	-	-	-	-	-	-	-	-	■	ms4-lfx
	6	■	■	-	-	-	-	-	-	-	-	-	-	-	-	■	ms6-lfx
	9	-	■	-	-	-	-	-	-	-	-	-	-	-	-	■	ms9-lfx
	12	-	■	-	-	-	-	-	-	-	-	-	-	-	-	■	ms12-lfx
Wasser- abscheider <b>MS-LWS</b>	4	-	-	-	-	-	-	-	-	-	-	-	-	-	-	-	-
	6	-	■	-	-	■	■	-	-	-	-	-	-	-	-	■	ms6-lws
	9	-	-	-	-	-	-	-	-	-	-	-	-	-	-	-	-
	12	-	-	-	-	-	-	-	-	-	-	-	-	-	-	-	-

# Membran-Lufttrockner MS-LDM1, Baureihe MS

Lieferübersicht Wartungsgeräte Baureihe MS



Typ	Bau- größe	Pneumatischer Anschluss im Gehäuse	Anschlussplatte	Druckregelbereich [bar]						Versorgungsspannung				
				0,05 ... 0,7	0,05 ... 2,5	0,1 ... 4	0,3 ... 7	0,1 ... 12	0,5 ... 16	24 V DC, Anschluss- bild nach EN 175301	24 V DC, Anschluss- bild M12 nach DESINA	110 V AC, Anschluss- bild nach EN 175301	230 V AC, Anschluss- bild nach EN 175301	
Code			AG...	D2	D4	D5	D6	D7	D8	V24	V24P	V110	V230	
<b>Einzelgeräte</b>														
Druckregel- ventile <b>MS-LR</b>		4	G <sup>1</sup> / <sub>8</sub> , G <sup>1</sup> / <sub>4</sub>	G <sup>1</sup> / <sub>8</sub> , G <sup>1</sup> / <sub>4</sub> , G <sup>3</sup> / <sub>8</sub>	-	-	■	■	■	-	-	-	-	
		6	G <sup>1</sup> / <sub>4</sub> , G <sup>3</sup> / <sub>8</sub> , G <sup>1</sup> / <sub>2</sub>	G <sup>1</sup> / <sub>4</sub> , G <sup>3</sup> / <sub>8</sub> , G <sup>1</sup> / <sub>2</sub> , G <sup>3</sup> / <sub>4</sub>	-	-	■	■	■	■	-	-	-	-
		9	-											
		12	-	G1, G1 <sup>1</sup> / <sub>4</sub> , G1 <sup>1</sup> / <sub>2</sub> , G2	-	-	-	■	■	■	-	-	-	-
Druckregel- ventile <b>MS-LRB</b>		4	G <sup>1</sup> / <sub>4</sub>	G <sup>1</sup> / <sub>8</sub> , G <sup>1</sup> / <sub>4</sub> , G <sup>3</sup> / <sub>8</sub>	-	-	■	■	■	-	-	-	-	
		6	G <sup>1</sup> / <sub>2</sub>	G <sup>1</sup> / <sub>4</sub> , G <sup>3</sup> / <sub>8</sub> , G <sup>1</sup> / <sub>2</sub> , G <sup>3</sup> / <sub>4</sub>	-	-	■	■	■	■	-	-	-	-
		9	-											
		12	-											
Präzisions- Druckregel- ventile <b>MS-LRP</b>		4	-											
		6	G <sup>1</sup> / <sub>4</sub> , G <sup>3</sup> / <sub>8</sub> , G <sup>1</sup> / <sub>2</sub>	G <sup>1</sup> / <sub>4</sub> , G <sup>3</sup> / <sub>8</sub> , G <sup>1</sup> / <sub>2</sub> , G <sup>3</sup> / <sub>4</sub>	■	■	■	-	■	-	-	-	-	-
		9	-											
		12	-											
Präzisions- Druckregel- ventile <b>MS-LRPB</b>		4	-											
		6	G <sup>1</sup> / <sub>2</sub>	G <sup>1</sup> / <sub>4</sub> , G <sup>3</sup> / <sub>8</sub> , G <sup>1</sup> / <sub>2</sub> , G <sup>3</sup> / <sub>4</sub>	■	■	■	-	■	-	-	-	-	-
		9	-											
		12	-											
Elektrik-Druck- regelventile <b>MS-LRE</b>		4	-											
		6	G <sup>1</sup> / <sub>4</sub> , G <sup>3</sup> / <sub>8</sub> , G <sup>1</sup> / <sub>2</sub>	G <sup>1</sup> / <sub>4</sub> , G <sup>3</sup> / <sub>8</sub> , G <sup>1</sup> / <sub>2</sub> , G <sup>3</sup> / <sub>4</sub>	-	-	■	■	■	■	-	-	-	-
		9	-											
		12	-											
Öler <b>MS-LOE</b>		4	G <sup>1</sup> / <sub>8</sub> , G <sup>1</sup> / <sub>4</sub>	G <sup>1</sup> / <sub>8</sub> , G <sup>1</sup> / <sub>4</sub> , G <sup>3</sup> / <sub>8</sub>	-	-	-	-	-	-	-	-	-	
		6	G <sup>1</sup> / <sub>4</sub> , G <sup>3</sup> / <sub>8</sub> , G <sup>1</sup> / <sub>2</sub>	G <sup>1</sup> / <sub>4</sub> , G <sup>3</sup> / <sub>8</sub> , G <sup>1</sup> / <sub>2</sub> , G <sup>3</sup> / <sub>4</sub>	-	-	-	-	-	-	-	-	-	-
		9	-											
		12	-	G1, G1 <sup>1</sup> / <sub>4</sub> , G1 <sup>1</sup> / <sub>2</sub> , G2	-	-	-	-	-	-	-	-	-	-
Einschalt- ventile <b>MS-EM(1)</b>		4	G <sup>1</sup> / <sub>8</sub> , G <sup>1</sup> / <sub>4</sub>	G <sup>1</sup> / <sub>8</sub> , G <sup>1</sup> / <sub>4</sub> , G <sup>3</sup> / <sub>8</sub>	-	-	-	-	-	-	-	-	-	
		6	G <sup>1</sup> / <sub>4</sub> , G <sup>3</sup> / <sub>8</sub> , G <sup>1</sup> / <sub>2</sub>	G <sup>1</sup> / <sub>4</sub> , G <sup>3</sup> / <sub>8</sub> , G <sup>1</sup> / <sub>2</sub> , G <sup>3</sup> / <sub>4</sub>	-	-	-	-	-	-	-	-	-	-
		9	-											
		12	-	G1, G1 <sup>1</sup> / <sub>4</sub> , G1 <sup>1</sup> / <sub>2</sub> , G2	-	-	-	-	-	-	-	-	-	-
Einschalt- ventile <b>MS-EE</b>		4	G <sup>1</sup> / <sub>8</sub> , G <sup>1</sup> / <sub>4</sub>	G <sup>1</sup> / <sub>8</sub> , G <sup>1</sup> / <sub>4</sub> , G <sup>3</sup> / <sub>8</sub>	-	-	-	-	-	-	■	-	■	■
		6	G <sup>1</sup> / <sub>4</sub> , G <sup>3</sup> / <sub>8</sub> , G <sup>1</sup> / <sub>2</sub>	G <sup>1</sup> / <sub>4</sub> , G <sup>3</sup> / <sub>8</sub> , G <sup>1</sup> / <sub>2</sub> , G <sup>3</sup> / <sub>4</sub>	-	-	-	-	-	-	■	-	■	■
		9	-											
		12	-	G1, G1 <sup>1</sup> / <sub>4</sub> , G1 <sup>1</sup> / <sub>2</sub> , G2	-	-	-	-	-	-	-	■	■	■
Druckaufbau- ventile <b>MS-DL</b>		4	G <sup>1</sup> / <sub>8</sub> , G <sup>1</sup> / <sub>4</sub>	G <sup>1</sup> / <sub>8</sub> , G <sup>1</sup> / <sub>4</sub> , G <sup>3</sup> / <sub>8</sub>	-	-	-	-	-	-	-	-	-	-
		6	G <sup>1</sup> / <sub>4</sub> , G <sup>3</sup> / <sub>8</sub> , G <sup>1</sup> / <sub>2</sub>	G <sup>1</sup> / <sub>4</sub> , G <sup>3</sup> / <sub>8</sub> , G <sup>1</sup> / <sub>2</sub> , G <sup>3</sup> / <sub>4</sub>	-	-	-	-	-	-	-	-	-	-
		9	-											
		12	-	G1, G1 <sup>1</sup> / <sub>4</sub> , G1 <sup>1</sup> / <sub>2</sub> , G2	-	-	-	-	-	-	-	-	-	-
Druckaufbau- ventile <b>MS-DE</b>		4	G <sup>1</sup> / <sub>8</sub> , G <sup>1</sup> / <sub>4</sub>	G <sup>1</sup> / <sub>8</sub> , G <sup>1</sup> / <sub>4</sub> , G <sup>3</sup> / <sub>8</sub>	-	-	-	-	-	-	■	-	■	■
		6	G <sup>1</sup> / <sub>4</sub> , G <sup>3</sup> / <sub>8</sub> , G <sup>1</sup> / <sub>2</sub>	G <sup>1</sup> / <sub>4</sub> , G <sup>3</sup> / <sub>8</sub> , G <sup>1</sup> / <sub>2</sub> , G <sup>3</sup> / <sub>4</sub>	-	-	-	-	-	-	■	-	■	■
		9	-											
		12	-	G1, G1 <sup>1</sup> / <sub>4</sub> , G1 <sup>1</sup> / <sub>2</sub> , G2	-	-	-	-	-	-	-	■	■	■
Druckaufbau- und Entlüf- tungsventile <b>MS-SV</b>		4	-											
		6	G <sup>1</sup> / <sub>2</sub>	G <sup>1</sup> / <sub>4</sub> , G <sup>3</sup> / <sub>8</sub> , G <sup>1</sup> / <sub>2</sub> , G <sup>3</sup> / <sub>4</sub>	-	-	-	-	-	-	■	-	-	-
		9	-											
		12	-											

# Membran-Lufttrockner MS-LDM1, Baureihe MS





Lieferübersicht Wartungsgeräte Baureihe MS

Typ	Bau- größe	Schalenschutz		Druckanzeige				Betätigungs- sicherung			Optionen		→ Seite/ Internet
		Kunststoffschutzkorb	Metallschale	Verschlussblende (ohne Manometer)	integriertes MS-Manometer	Adapter EN-Manometer G1/8	Adapter EN-Manometer G1/4	Drucksensor	Drehknopf, abschließbar	Drehknopf, lang	Schalldämpfer	Durchflussrichtung von rechts nach links	
Code		R	U	VS	AG	A8	A4	AD...	AS	LD	S	Z	
<b>Einzelgeräte</b>													
Druckregel- ventile <b>MS-LR</b>	4	-	-	■	■	■	■	■	■	■	-	■	ms4-lr
	6	-	-	■	■	-	■	■	■	■	-	■	ms6-lr
	9	-	-	-	-	-	-	-	-	-	-	-	-
	12	-	-	■	■	-	■	-	■	■	-	■	ms12-lr
Druckregel- ventile <b>MS-LRB</b>	4	-	-	■	■	■	■	■	■	■	-	■	ms4-lrb
	6	-	-	■	■	-	■	■	■	■	-	■	ms6-lrb
	9	-	-	-	-	-	-	-	-	-	-	-	-
	12	-	-	-	-	-	-	-	-	-	-	-	-
Präzisions- Druckregel- ventile <b>MS-LRP</b>	4	-	-	■	-	■	■	■	■	■	-	■	ms6-lrp
	6	-	-	■	-	■	■	■	■	■	-	■	ms6-lrp
	9	-	-	-	-	-	-	-	-	-	-	-	-
	12	-	-	-	-	-	-	-	-	-	-	-	-
Präzisions- Druckregel- ventile <b>MS-LRPB</b>	4	-	-	■	-	■	■	■	■	■	-	■	ms6-lrpb
	6	-	-	■	-	■	■	■	■	■	-	■	ms6-lrpb
	9	-	-	-	-	-	-	-	-	-	-	-	-
	12	-	-	-	-	-	-	-	-	-	-	-	-
Elektrik-Druck- regelventile <b>MS-LRE</b>	4	-	-	■	■	-	■	-	-	-	-	■	ms6-lre
	6	-	-	■	■	-	■	-	-	-	-	■	ms6-lre
	9	-	-	-	-	-	-	-	-	-	-	-	-
	12	-	-	-	-	-	-	-	-	-	-	-	-
Öler <b>MS-LOE</b>	4	■	■	-	-	-	-	-	-	-	-	■	ms4-loe
	6	■	■	-	-	-	-	-	-	-	-	■	ms6-loe
	9	-	-	-	-	-	-	-	-	-	-	-	-
	12	-	■	-	-	-	-	-	-	-	-	■	ms12-loe
Einschalt- ventile <b>MS-EM(1)</b>	4	-	-	■	■	■	■	■	-	-	■	■	ms4-em1
	6	-	-	■	■	-	■	■	-	-	■	■	ms6-em1
	9	-	-	-	-	-	-	-	-	-	-	-	-
	12	-	-	■	■	-	■	-	-	-	■	■	ms12-em
Einschalt- ventile <b>MS-EE</b>	4	-	-	■	■	■	■	■	-	-	■	■	ms4-ee
	6	-	-	■	■	-	■	■	-	-	■	■	ms6-ee
	9	-	-	-	-	-	-	-	-	-	-	-	-
	12	-	-	■	■	-	■	-	-	-	■	■	ms12-ee
Druckaufbau- ventile <b>MS-DL</b>	4	-	-	■	■	■	■	■	-	-	-	■	ms4-dl
	6	-	-	■	■	-	■	■	-	-	-	■	ms6-dl
	9	-	-	-	-	-	-	-	-	-	-	-	-
	12	-	-	■	■	-	■	-	-	-	-	■	ms12-dl
Druckaufbau- ventile <b>MS-DE</b>	4	-	-	■	■	■	■	■	-	-	-	■	ms4-de
	6	-	-	■	■	-	■	■	-	-	-	■	ms6-de
	9	-	-	-	-	-	-	-	-	-	-	-	-
	12	-	-	■	■	-	■	-	-	-	-	■	ms12-de
Druckaufbau- und Entlüf- tungsventile <b>MS-SV</b>	4	-	-	■	■	-	■	■	-	-	■	■	ms6-sv
	6	-	-	■	■	-	■	■	-	-	■	■	ms6-sv
	9	-	-	-	-	-	-	-	-	-	-	-	-
	12	-	-	-	-	-	-	-	-	-	-	-	-

# Membran-Lufttrockner MS-LDM1, Baureihe MS

FESTO

Lieferübersicht Wartungsgeräte Baureihe MS

Typ	Bau- größe	Pneumatischer Anschluss im Gehäuse	Anschlussplatte	Druckregelbereich [bar]				Versorgungsspannung			
				0,1 ... 4	0,3 ... 7	0,1 ... 12	0,5 ... 16	24 V DC, Anschluss- bild nach EN 175301	24 V DC, Anschluss- bild M12 nach DESINA	110 V AC, Anschluss- bild nach EN 175301	230 V AC, Anschluss- bild nach EN 175301
Code			AG...	D5	D6	D7	D8	V24	V24P	V110	V230
<b>Einzelgeräte</b>											
Membran- Lufttrockner <b>MS-LDM1</b>		4	G $\frac{1}{8}$ , G $\frac{1}{4}$	G $\frac{1}{8}$ , G $\frac{1}{4}$ , G $\frac{3}{8}$	-	-	-	-	-	-	-
		6	G $\frac{1}{4}$ , G $\frac{3}{8}$ , G $\frac{1}{2}$	G $\frac{1}{4}$ , G $\frac{3}{8}$ , G $\frac{1}{2}$ , G $\frac{3}{4}$	-	-	-	-	-	-	-
		9	-	-	-	-	-	-	-	-	-
		12	-	-	-	-	-	-	-	-	-
Abzweig- module <b>MS-FRM</b>		4	G $\frac{1}{8}$ , G $\frac{1}{4}$	G $\frac{1}{8}$ , G $\frac{1}{4}$ , G $\frac{3}{8}$	-	-	-	-	-	-	-
		6	G $\frac{1}{4}$ , G $\frac{3}{8}$ , G $\frac{1}{2}$	G $\frac{1}{4}$ , G $\frac{3}{8}$ , G $\frac{1}{2}$ , G $\frac{3}{4}$	-	-	-	-	-	-	-
		9	-	-	-	-	-	-	-	-	-
		12	-	G1, G1 $\frac{1}{4}$ , G1 $\frac{1}{2}$ , G2	-	-	-	-	-	-	-
Verteiler- blöcke <b>MS-FRM-FRZ</b>		4	G $\frac{1}{4}$	-	-	-	-	-	-	-	-
		6	G $\frac{1}{2}$	-	-	-	-	-	-	-	-
		9	-	-	-	-	-	-	-	-	-
		12	-	-	-	-	-	-	-	-	-
Durchfluss- sensoren <b>MS-SFE</b>		4	-	-	-	-	-	-	-	-	-
		6	G $\frac{1}{2}$	G $\frac{1}{2}$	-	-	-	-	-	-	-
		9	-	-	-	-	-	-	-	-	-
		12	-	-	-	-	-	-	-	-	-
Durchfluss- sensoren <b>SFAM</b>		4	-	-	-	-	-	-	-	-	-
		6	G $\frac{1}{2}$	G $\frac{1}{2}$	-	-	-	-	-	-	-
		9	-	-	-	-	-	-	-	-	-
		12	-	-	-	-	-	-	-	-	-

# Membran-Lufttrockner MS-LDM1, Baureihe MS



Lieferübersicht Wartungsgeräte Baureihe MS

Typ	Bau- größe	Schalenschutz		Druckanzeige				Schaltausgang		Optionen		→ Seite/ Internet	
		Kunststoffschutzkorb	Metallschale	Verschlussblende (ohne Manometer)	integriertes MS-Manometer	Adapter EN-Manometer G $\frac{1}{8}$	Adapter EN-Manometer G $\frac{1}{4}$	Drucksensor	2x PNP	2x NPN	Schalldämpfer		Durchflussrichtung von rechts nach links
Code		R	U	VS	AG	A8	A4	AD...	P2/2S	N2/2S	S	Z/R	
<b>Einzelgeräte</b>													
Membran- Lufttrockner <b>MS-LDM1</b>	4	-	■	-	-	-	-	-	-	-	-	■	8
	6	-	■	-	-	-	-	-	-	-	-	■	8
	9	-	-	-	-	-	-	-	-	-	-	-	-
	12	-	-	-	-	-	-	-	-	-	-	-	-
Abzweig- module <b>MS-FRM</b>	4	-	-	■	■	■	■	■	-	-	-	■	ms4-frm
	6	-	-	■	■	-	■	■	-	-	-	■	ms6-frm
	9	-	-	-	-	-	-	-	-	-	-	-	-
	12	-	-	■	-	-	-	-	-	-	-	-	ms12-frm
Verteiler- blöcke <b>MS-FRM-FRZ</b>	4	-	-	-	-	-	-	-	-	-	-	■	ms4-frm
	6	-	-	-	-	-	-	-	-	-	-	■	ms6-frm
	9	-	-	-	-	-	-	-	-	-	-	-	-
	12	-	-	-	-	-	-	-	-	-	-	-	-
Durchfluss- sensoren <b>MS-SFE</b>	4	-	-	-	-	-	-	-	■	■	-	■ <sup>1)</sup>	ms6-sfe
	6	-	-	-	-	-	-	-	■	■	-	■ <sup>1)</sup>	ms6-sfe
	9	-	-	-	-	-	-	-	-	-	-	-	-
	12	-	-	-	-	-	-	-	-	-	-	-	-
Durchfluss- sensoren <b>SFAM</b>	4	-	-	-	-	-	-	-	■	■	-	■	sfam
	6	-	-	-	-	-	-	-	■	■	-	■	sfam
	9	-	-	-	-	-	-	-	-	-	-	-	-
	12	-	-	-	-	-	-	-	-	-	-	-	-

1) Nur über Konfigurator bestellbar → Internet: ms6-sfe

# Membran-Lufttrockner MS4/MS6-LDM1, Baureihe MS

Peripherieübersicht

FESTO

## Membran-Lufttrockner MS4/MS6-LDM1

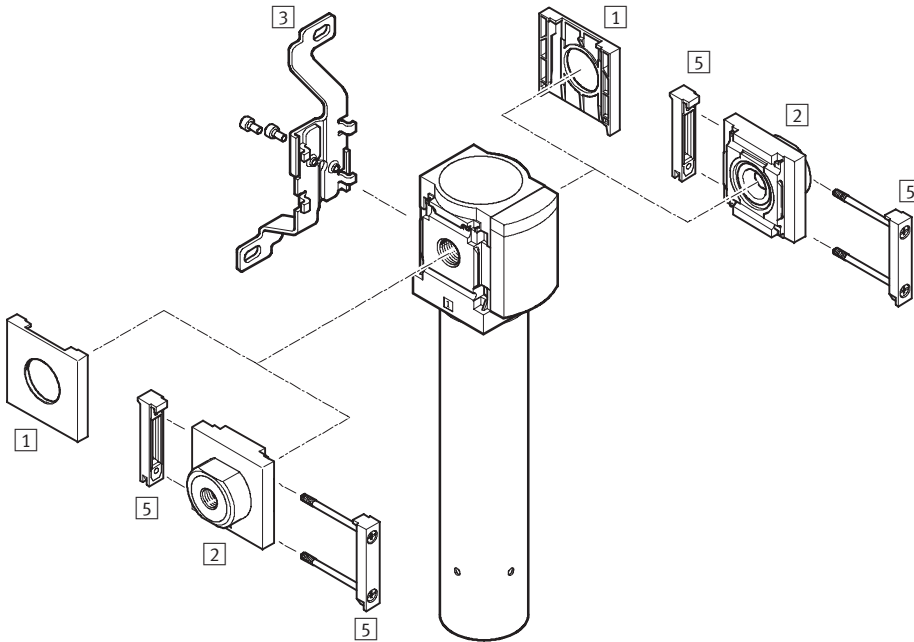

 Hinweis

Weiteres Zubehör:

- Modulverbinder für Kombination mit Baugröße MS4/MS6 oder Baugröße MS9 → Internet: amv, rmv, armv
- Adapter für Montage an Profile → Internet: ipm-80, ipm-40-80, ipm-80-80

Befestigungselemente und Zubehör					
	Einzelgerät		Kombination		→ Seite/Internet
	ohne Anschlussplatte	mit Anschlussplatte	ohne Anschlussplatte	mit Anschlussplatte	
1 Abdeckkappe MS4/6-END	■	-	■	-	ms4-end, ms6-end
2 Anschlussplatte MS4/6-AG...	-	■	-	■	ms4-ag, ms6-ag
3 Befestigungswinkel MS4/6-WB	■	■	-	-	ms4-wb, ms6-wb
5 Modulverbinder MS4/6-MV	-	■	■	■	ms4-mv, ms6-mv
- Befestigungswinkel MS4-WBM	■	■	-	-	ms4-wbm
- Befestigungswinkel MS4/6-WP/WPB/WPE/WPM	-	■	■	■	ms4-wp, ms6-wp



# Membran-Lufttrockner MS4/MS6-LDM1, Baureihe MS

Typenschlüssel

MS 6 - LDM1 - 1/2 - P20

## Baureihe

MS	Wartungseinheit Standard
----	--------------------------

## Baugröße

4	Rastermaß 40 mm
6	Rastermaß 62 mm

## Wartungsfunktion

LDM1	Membran-Lufttrockner
------	----------------------

## Anschlussgröße

MS4	
1/8	Gewinde G1/8
1/4	Gewinde G1/4
MS6	
1/4	Gewinde G1/4
3/8	Gewinde G3/8
1/2	Gewinde G1/2

## Durchflusspatrone

P10	Patrone P10
P20	Patrone P20
P40	Patrone P40

Weitere Varianten können Sie über den Produktbaukasten bestellen → 15

- Anschlussplatten
- Durchflusspatrone
- Gefasste Spülluft
- Befestigungsart
- Alternative Durchflussrichtung

# Membran-Lufttrockner MS4/MS6-LDM1, Baureihe MS

FESTO

Datenblatt

Funktion

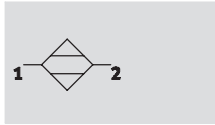

- - Durchfluss  
50 ... 400 l/min

- - Temperaturbereich  
+2 ... +50 °C

- - Eingangsdruck  
3 ... 12,5 bar

Druck-Taupunkt-Absenkung:  
20 K



- Optimaler Endstellen-Trockner mit hoher Funktionssicherheit
- Geeignet für den Einsatz als Einzelgerät oder zur Integration in bestehende Luftaufbereitungsgeräte-Kombinationen
- Durchflussabhängige Taupunktabsenkung

- Verschleißfreie Funktion ohne externe Energie
- Zusammensetzung der Druckluft bleibt durch den Trocknungsprozess nahezu unverändert
- 15% Spülluftrate
- Optionaler Spülring zum Fassen der Spülluft

Typische Einsatzgebiete:

- Trocknung, Reinigung von Präzisionsteilen
- Messtechnik
- Spülung von Glasmaßstäben
- Lackieranlagen
- Papier- und Verpackungsmaschinen

- - Hinweis

Für die einwandfreie Funktion des Gerätes ist die Vorfiltration der Druckluft mit Feinstfilter MS-LFM-A, Filterfeinheit 0,01 µm (Restpartikel < 0,1 µm, Restölgehalt < 0,1 mg/m<sup>3</sup>) unbedingt erforderlich!

## Allgemeine Technische Daten

Baugröße	MS4		MS6		
	Pneumatischer Anschluss 1, 2	G1/8	G1/4	G1/4	G3/8
Konstruktiver Aufbau	Membrantrockner mit Eigenluftverbrauch				
Befestigungsart	mit Zubehör				
	Leitungseinbau				
Einbaulage	senkrecht ±5°				

- - Hinweis: Dieses Produkt entspricht ISO 1179-1 und ISO 228-1.

## Normaldurchfluss q<sub>n</sub><sup>1)</sup> [l/min]

Baugröße	MS4		MS6		
	Patrone P05	Patrone P10	Patrone P20	Patrone P30	Patrone P40
Eingang q <sub>n</sub> Ein	59	118	235	353	471
Ausgang q <sub>n</sub> Aus	50	100	200	300	400
Spülluft q <sub>n</sub> Purge	8,8	17,6	35,3	52,9	70,6

1) Gemessen bei p<sub>1</sub> = 6,9 bar, θ<sub>pd</sub> Ein = 25 °C, θ<sub>pd</sub> Aus = 5 °C ± 1,5 °C (θ<sub>pa</sub> Aus = -21,5 °C ± 1,2 °C), θ<sub>amb</sub> = 25 °C

## Betriebs- und Umweltbedingungen

Eingangsdruck [bar]	3 ... 12,5
Betriebsmedium	Druckluft, Luftqualitätsklasse 1.7.2 nach DIN ISO 8573-1
Druck-Taupunkt-Absenkung [K]	20
Umgebungstemperatur [°C]	+2 ... +50
Mediumtemperatur [°C]	+2 ... +50
Lagertemperatur [°C]	-20 ... +60
Korrosionsbeständigkeit KBK <sup>1)</sup>	2

1) Korrosionsbeständigkeitsklasse 2 nach Festo Norm 940 070  
Bauteile mit mäßiger Korrosionsbeanspruchung. Außenliegende sichtbare Teile mit vorrangig dekorativer Anforderung an die Oberfläche, die im direkten Kontakt zur umgebenden industriellen Atmosphäre bzw. Medien, wie Kühl- und Schmierstoffe stehen.

# Membran-Lufttrockner MS4/MS6-LDM1, Baureihe MS

Datenblatt

Gewichte [g]					
Baugröße	MS4		MS6		
	Patrone P05	Patrone P10	Patrone P20	Patrone P30	Patrone P40
Membran-Lufttrockner	420	530	1 050	1 200	1 300

## Werkstoffe

Funktionsschnitt

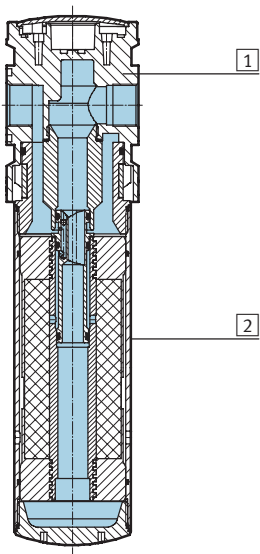

Membran-Lufttrockner	
1	Gehäuse Aluminium-Druckguss
2	Schale Aluminium-Knetlegierung
-	Dichtungen Nitrilkautschuk

# Membran-Lufttrockner MS4/MS6-LDM1, Baureihe MS

Datenblatt

FESTO

## Drucktaupunkt $t_{pd}$ (Ausgang) in Abhängigkeit vom Normaldurchfluss am Ausgang $q_n$

MS4-LDM1-...-P05

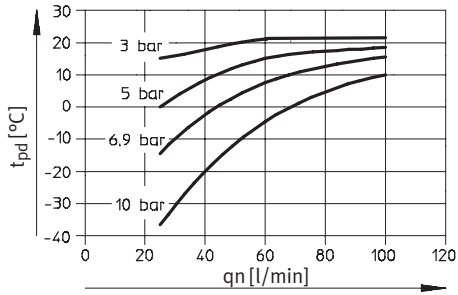

MS4-LDM1-...-P10

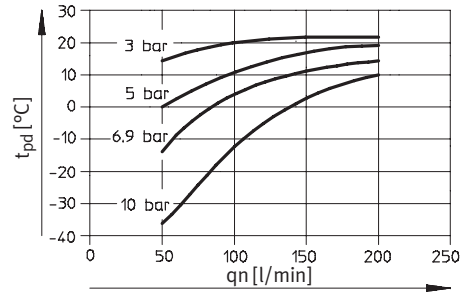

MS6-LDM1-...-P20

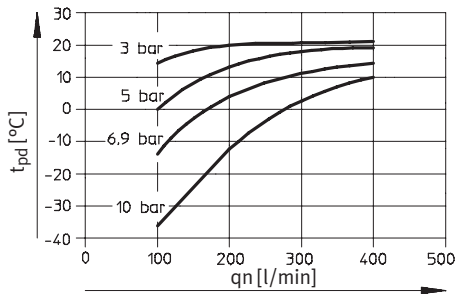

MS6-LDM1-...-P30

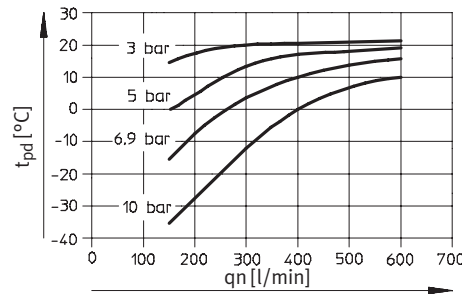

MS6-LDM1-...-P40

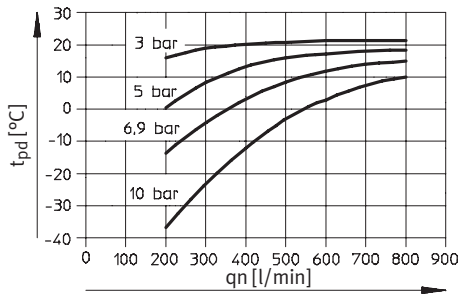

# Membran-Lufttrockner MS4/MS6-LDM1, Baureihe MS

Datenblatt

## Differenzdruck $\Delta p$ in Abhängigkeit vom Normaldurchfluss am Ausgang $q_n$

MS4-LDM1-...-P05

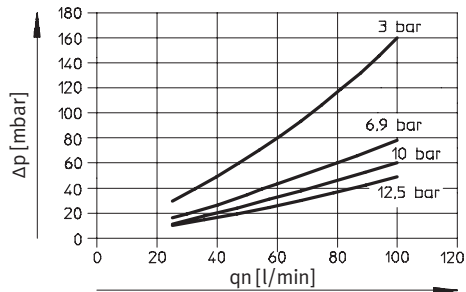

MS4-LDM1-...-P10

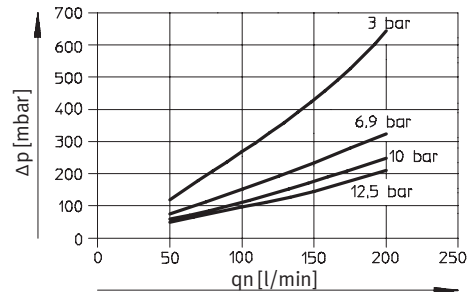

MS6-LDM1-...-P20

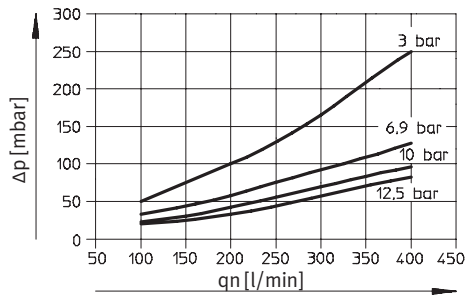

MS6-LDM1-...-P30

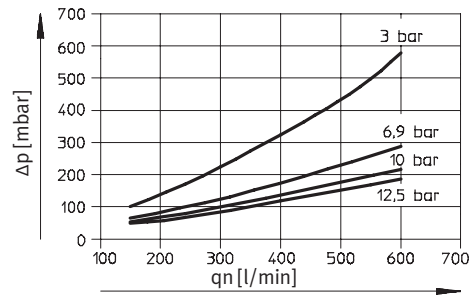

MS6-LDM1-...-P40

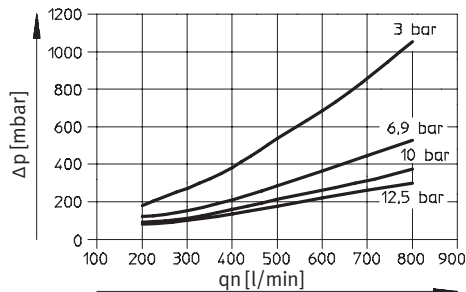

# Membran-Lufttrockner MS4/MS6-LDM1, Baureihe MS

Datenblatt

FESTO

## Abmessungen

Download CAD-Daten → [www.festo.com](http://www.festo.com)

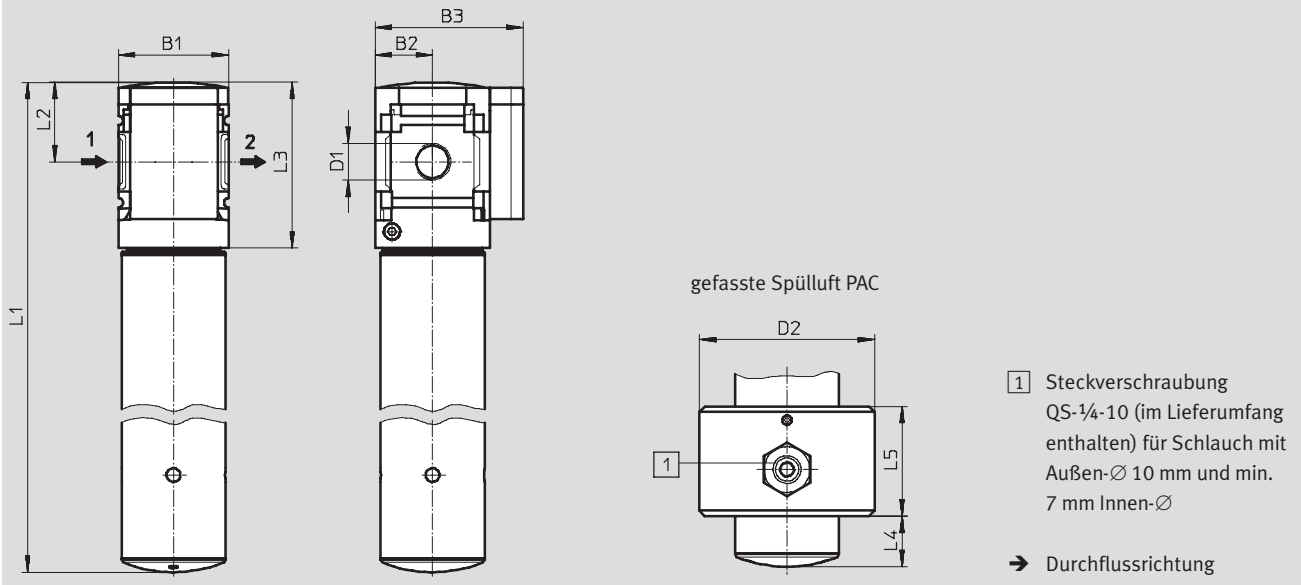

Typ	B1	B2	B3	D1	D2	L1	L2	L3	L4	L5
MS4-LDM1-1/8-P05	40	21	54	G1/8	64	245	29	60	18	40
MS4-LDM1-1/8-P10						345				
MS4-LDM1-1/4-P05	40	21	54	G1/4	64	245	29	60	18	40
MS4-LDM1-1/4-P10						345				
MS6-LDM1-1/4-P20	62	31	76	G1/4	80	345	42	87	34	40
MS6-LDM1-1/4-P30						415				
MS6-LDM1-1/4-P40						475				
MS6-LDM1-3/8-P20	62	31	76	G3/8	80	345	42	87	34	40
MS6-LDM1-3/8-P30						415				
MS6-LDM1-3/8-P40						475				
MS6-LDM1-1/2-P20	62	31	76	G1/2	80	345	42	87	34	40
MS6-LDM1-1/2-P30						415				
MS6-LDM1-1/2-P40						475				

• Hinweis: Dieses Produkt entspricht ISO 1179-1 und ISO 228-1.

## Bestellangaben

Baugröße	Durchflusspatrone	Anschluss	Teile-Nr.	Typ
MS4	P10	G1/8	543630	MS4-LDM1-1/8-P10
		G1/4	543632	MS4-LDM1-1/4-P10
MS6	P20	G1/4	543640	MS6-LDM1-1/4-P20
		G3/8	543642	MS6-LDM1-3/8-P20
		G1/2	543644	MS6-LDM1-1/2-P20
	P40	G1/4	543646	MS6-LDM1-1/4-P40
		G3/8	543648	MS6-LDM1-3/8-P40
		G1/2	543650	MS6-LDM1-1/2-P40

# Membran-Lufttrockner MS4/MS6-LDM1, Baureihe MS



Bestellangaben – Produktbaukasten

M Mindestangaben					O Optionen			
Baukasten-Nr.	Bau-reihe	Bau-größe	Funktion	Anschluss-größe	Durchfluss-patrone	Spülluft	Befesti-gungsart	Alternative Durchfluss-richtung
543628 543638	MS	4 6	LDM1	1/8, 1/4, 3/8, 1/2 AGA, AGB, AGC, AGD, AGE	P05 P10 P20 P30 P40	PAC	WP WPM WB WBM	Z
<b>Bestell-beispiel</b>								
<b>543628</b>	<b>MS</b>	<b>4</b>	<b>- LDM1</b>	<b>- AGC</b>	<b>- P10</b>	<b>-</b>	<b>- WP</b>	<b>-</b>

Bestelltabelle							
Rastermaß	[mm]	40	62	Bedin-gungen	Code	Eintrag Code	
M	Baukasten-Nr.	<b>543628</b>		<b>543638</b>			
	Baureihe	Standard			<b>MS</b>		MS
	Baugröße	4		6	...		
	Funktion	Membrantrockner			<b>-LDM1</b>		-LDM1
	Anschlussgröße	Gewinde G1/8		-	-1/8		
		Gewinde G1/4		Gewinde G1/4	-1/4		
		-		Gewinde G3/8	-3/8		
		-		Gewinde G1/2	-1/2		
		Anschlussplatte G1/8		-	<b>-AGA</b>		
		Anschlussplatte G1/4		Anschlussplatte G1/4	<b>-AGB</b>		
		Anschlussplatte G3/8		Anschlussplatte G3/8	<b>-AGC</b>		
		-		Anschlussplatte G1/2	<b>-AGD</b>		
	Durchflusspatrone	50 l/min		-	<b>-P05</b>		
		100 l/min		-	<b>-P10</b>		
		-		200 l/min	<b>-P20</b>		
		-		300 l/min	<b>-P30</b>		
		-		400 l/min	<b>-P40</b>		
		-					
O	Spülluft	gefasste Spülluft			<b>-PAC</b>		
	Befestigungsart	Befestigungswinkel		1	<b>-WP</b>		
		Befestigungswinkel		1	<b>-WPM</b>		
		Befestigungswinkel			<b>-WB</b>		
		Befestigungswinkel		-	<b>-WBM</b>		
	Alternative Durchfluss-richtung	Durchflussrichtung von rechts nach links			<b>-Z</b>		

1 WP, WPM Nur mit Anschlussplatte AGA, AGB, AGC, AGD oder AGE

Übertrag Bestellcode

	<b>MS</b>		<b>- LDM1</b>						
--	-----------	--	---------------	--	--	--	--	--	--