

# Mounting attachments

Technical data

Mounting attachments enable valve terminals to be attached to walls and machine parts







Ordering data – H-rail mountings						
View	Product weight [g]	Material	Function	Dimensions [mm]	Part No.	Type
	69.6	Cold rolled steel	Mounting accessories (set) for H-rail mounting. Enables suitable valve terminals/modules to be attached to an H-rail. Has a small swivel lever on the right and left and mounting accessories.	62x24x13.5 (LxWxH) Material thickness: 3	<b>18 649</b>	<b>IBGH-03-4,0</b>
	79.5		Mounting accessories (set) for H-rail mounting. Enables suitable valve terminals/modules to be attached to an H-rail. Has a small swivel lever on the left, a large swivel lever on the right and mounting accessories.	62x24x13.5 81x24x13.5 (LxWxH) Material thickness: 3	<b>18 747</b>	<b>IBGH-03-7,0</b>
	44.1		Mounting accessories (set) for H-rail mounting. Enables suitable valve terminals/modules to be attached to an H-rail. Has a small swivel lever on the right and mounting accessories.	62x24x13.5 (LxWxH) Material thickness: 3	<b>526 033</b>	<b>CPX-03-4,0</b>
	48.3		Mounting accessories (set) for H-rail mounting. Enables suitable valve terminals/modules to be attached to an H-rail. Has a large swivel lever on the right and mounting accessories.	81x24x13.5 (LxWxH) Material thickness: 3	<b>526 034</b>	<b>CPX-03-7,0</b>

# Mounting attachments

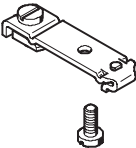
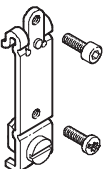
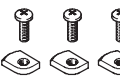
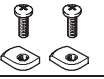
Technical data

**FESTO**

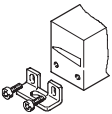



Ordering data – General attachments						
View	Product weight [g]	Material	Function	Dimensions [mm]	Part No.	Type
	35.1	Steel/polymer material	Base for H-rail mounting. Is screwed onto the component and the entire unit can then be placed on an H-rail.	47x12x18.1 (LxWxH)	<b>170 169</b>	<b>CP-TS-HS-35</b>
	29.9	Cold rolled steel	Mounting rail for H-rail mounting. Is screwed onto the component and the entire unit can then be placed on an H-rail. Includes M4x10 screw (combi cross-slot screws).	49.1x13x8.7 (LxWxH) Material thickness: 2	<b>527 392</b>	<b>CPASC1-BG-NRH</b>
	15.2	Cold rolled steel	Mounting rail for H-rail mounting. Is screwed onto the component and the entire unit can then be placed on an H-rail. Includes 2 M3x6 screws (Torx).	55.1x13x7.7 (LxWxH) Material thickness: 2	<b>536 689</b>	<b>CPX-MMI-1-NRH</b>
	10.5	Cold rolled steel	Clamping components for H-rail mounting. Are screwed onto the component and clamp it onto an H-rail. Includes M4x12 screw (combi cross-slot screws).	8 x 11.8 (LxW) Material thickness: 2.5	<b>526 032</b>	<b>CPX-CPA-BG-NRH</b>
	8.8				<b>173 498</b>	<b>CPA-BG-NRH</b>
	600	Steel	H-rail Is screwed onto an even surface (wall) and can then support a large number of components.	35 x 7.5 (WxH) Material thickness: 1 Length acc. to requirements	<b>35 430</b>	<b>NRH-35-2000</b>

Ordering data – Wall mountings						
View	Product weight [g]	Material	Function	Dimensions [mm]	Part No.	Type
	8.8	Fine grained cold pressed steel	Mounting bracket for mounting valve terminals on even surfaces. Includes 2 M3x9 screws (internal hexagon socket SW 2.5)	18 x 15 (LxW) Material thickness: 2	<b>534 416</b>	<b>VMPA-BG-RW</b>
	23.5	Structural steel	Mounting bracket for mounting valve terminals on even surfaces. Includes 2 M3x10 screws (cross slot).	20 x 34 (LxW) Material thickness: 2	<b>18 678</b>	<b>IBGW-03</b>
	28.8	Semi-aromatic polyamide (IXEF)	Mounting bracket, acts as additional mounting for larger valve terminals	15x10.8x17.5 (LxWxH)	<b>529 040</b>	<b>CPX-BG-RW-10x</b>

# Mounting attachments

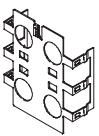
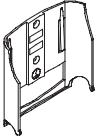
Technical data

FESTO

Ordering data – General attachments						
View	Product weight [g]	Material	Function	Dimensions [mm]	Part No.	Type
	20	Tin-plated bronze	Screening plate, is placed on a CPX module and screens it electromagnetically.	59.9x50.5x16 (LxWxH)	526 184	CPX-AB-S-4-M12
	25.2	Steel	Allows the MMI to be mounted at any position	84.3x92 (WxH)	534 705	CPX-MMI-1-H
	0.7	Galvanised free cutting steel	Is inserted in holes on a housing plate and enables a Sub-D plug to be screwed on	L: 10; M4 thread	366 598	4-40UNC
				L: 10; M3 thread	340 960	UNC 4-40/M3x5
				L: 11; M3 thread	533 000	UNC 4-40/M3x6
	60	Acc. to individual components	Mounting set for CDVI valve terminal; for mounting on machine parts	–	534 436	CDSV5.0
	–	Galvanised steel	Screw available as spare part, to DIN 912	L: 45; thread: M3	527 643	M3x45
	23.9	Tempered steel	Tie rod, allows CPX individual components to be assembled to form a unit. Available in different lengths for a different number of modules, standard thread M4.	60 (L) Expansion for 1 module	525 418	CPX-ZA-1-E
	42.1			72.1 (L) 1 module	195 718	CPX-ZA-1
	73.7			122.2 (L) 2 modules	195 720	CPX-ZA-2
	103.9			172.3 (L) 3 modules	195 722	CPX-ZA-3
	133			222.4 (L) 4 modules	195 724	CPX-ZA-4
	167.7			272.5 (L) 5 modules	195 726	CPX-ZA-5
	197.3			322.6 (L) 6 modules	195 728	CPX-ZA-6
	225.4			372.7 (L) 7 modules	195 730	CPX-ZA-7
	254.4			422.8 (L) 8 modules	195 732	CPX-ZA-8
	280.3			472.9 (L) 9 modules	195 734	CPX-ZA-9
310	523 (L) 10 modules	195 736	CPX-ZA-10			

# Mounting attachments

Technical data

FESTO

## Examples illustrating H-rail mounting

### With swivel levers

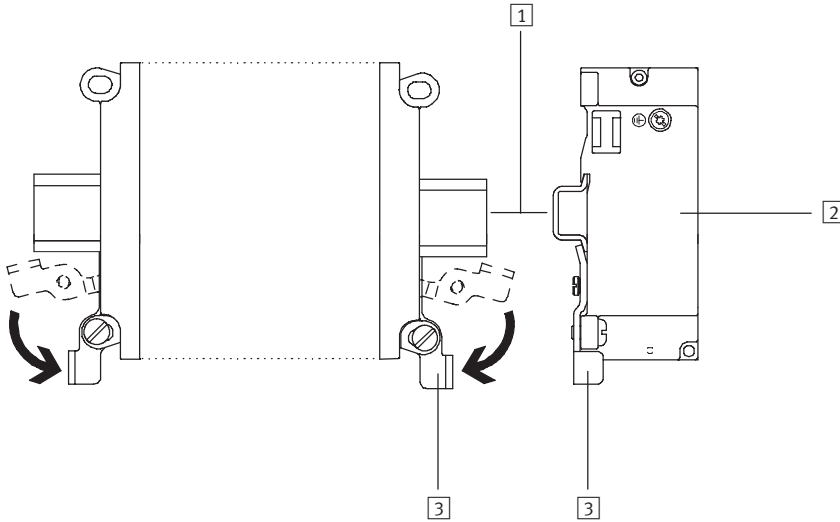

The valve terminal is attached to the H-rail and locked with the swivel lever.

- 1 H-rail
- 2 Valve terminal
- 3 Swivel lever

### With mounting rail

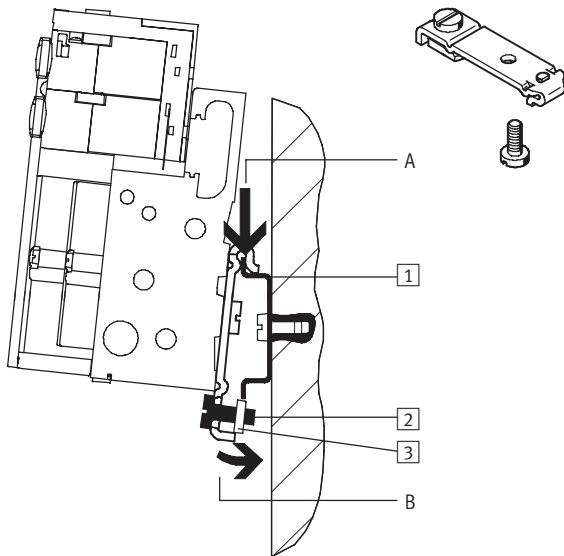

The valve terminal is attached to the H-rail (see arrow A).  
The valve terminal is then swivelled on the H-rail and secured in place with the clamping component (see arrow B).

- 1 Holes for wall mounting
- 2 Self-tapping M4x10 screw of the H-rail clamping unit
- 3 Clamping component of the H-rail clamping unit

### With clamping components

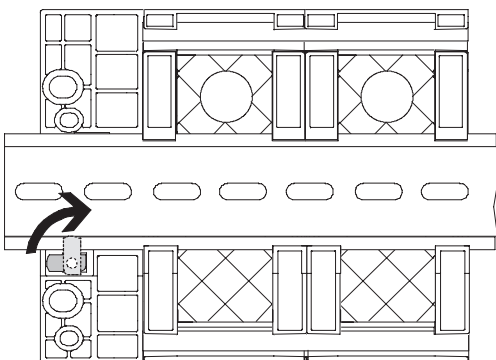

The H-rail mounting is pressed into the reverse profile of the (CPX) modules. The modules can be attached to the H-rail using the H-rail mounting.

# Mounting attachments

Technical data

## Examples illustrating wall mounting

With mounting bracket

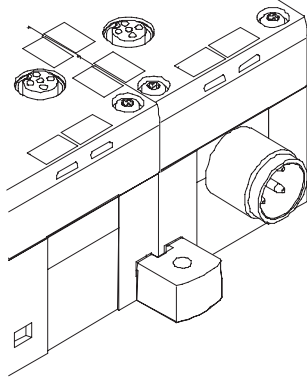

For longer valve terminals, there is an additional mounting bracket (for the CPX terminal) that can be fitted in any module.

## Examples illustrating general types of mounting

With tie rod

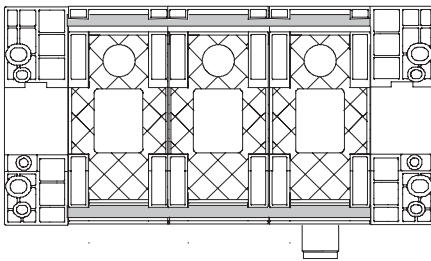

The mechanical connection between the CPX modules is created using special tie rods. Two screws in the end plates are all that are needed to mount the entire unit.

The tie rod ensures that the unit resists high mechanical loads and is therefore the “mechanical backbone” of the CPX terminal.

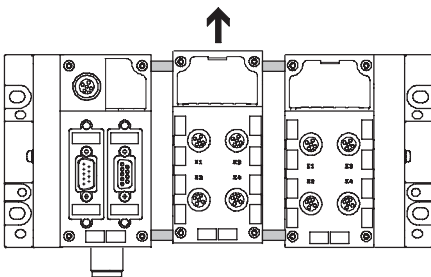

The open design allows interlinking blocks to be replaced in the assembled state.

The tie rod expansion kit allows an extra module to be added to the CPX terminal.