

Pressure sensors SPAB, with display

Product range overview



- Pressure measuring range –1 ... +1 or 0 ... 10 bar
- Relative pressure measurement
- Pressure supply port G1/8, R1/8 or NPT1/8-27
- Switch output PNP, NPN and analogue output
- Two-part, multi-coloured display
- Copy function (settings can be transferred from device to device)
- Simple commissioning thanks to intuitive operation
- Compact design 30x30 mm

Detailed product information

➔ www.festo.com/catalogue/spab

Product range overview							
Method of measurement	Measured variable	Pressure measuring range [bar]	Switching function	Pneumatic connection		Electrical output	
				Male thread	Female thread	Digital	Analogue
Piezoresistive pressure sensor with display	1x relative pressure	–1 ... +1 or 0 ... 10	Freely programmable	G1/8, R1/8 or NPT1/8-27	M5	1x PNP	1 ... 5 V
						2x PNP	–
						1x NPN	1 ... 5 V
						2x NPN	–

Pressure sensors SPAB, with display

Type codes

FESTO

		SPAB	-	P10	R	-	G18	-	PB	-	K1	
Sensor function		SPAB	Piezoresistive pressure sensor with multi-coloured display									
Pressure measuring range		B2	-1 ... +1 bar									
	P10	0 ... 10 bar										
Measured variable		R	Relative pressure									
Pneumatic connection		G18	Male thread G1/8 and female thread M5									
	R18	Male thread R1/8 and female thread M5										
	N18	Male thread NPT1/8-27 and female thread M5										
Electrical output		2P	2 switch outputs PNP									
	2N	2 switch outputs NPN										
	PB	1 switch output PNP and 1 ... 5 V analogue										
	NB	1 switch output NPN and 1 ... 5 V analogue										
Electrical connection		K1	Cable, 2.5 m long (included in scope of delivery)									
	M8	Plug M8x1										

Pressure sensors SPAB, with display

Technical data

General technical data				
Design				
Pressure measuring range	[bar]	-1 ... +1	0 ... 10	
Measured variable	Relative pressure			
Pneumatic connection	Male thread G1/8, R1/8 or NPT1/8-27 Female thread M5			
Type of display	Multi-coloured illuminated LCD			
Accuracy FS ¹⁾		±1%	±2%	
Setting options	Via display and buttons Teach-in			
Type of mounting	Screw-in Via accessories			
Electrical data				
Switch output		2x PNP or 2x NPN	1x PNP or 1x NPN	2x PNP or 2x NPN
Analogue output	[V]	-	1 ... 5	1 ... 5
Switching element function	Switchable			
Switching function	Freely programmable			
Operating voltage range	[V DC]	12 ... 24		
Max. output current	[mA]	100		
Electrical connection	Plug M8x1, 4-pin, round design to EN 60 947-5-2 Cable, 4-wire			
Protection against short circuit	Yes			
Protection against polarity reversal	For operating voltage			
Protection class	IP40			
Operating and environmental conditions				
Operating medium	Filtered compressed air, unlubricated, grade of filtration 40 µm			
Ambient temperature	[°C]	-10 ... +50		
CE mark (see declaration of conformity)	In accordance with EU EMC directive			
Certification	UL - Recognized (OL) C tick			
Materials				
Housing	Reinforced acrylic butadiene styrene, reinforced polybutylene terephthalate			
Note on materials	Conforms to RoHS Contains paint wetting impairment substances			

1) % FS = % of measuring range (full scale)

Pressure sensors SPAB, with display

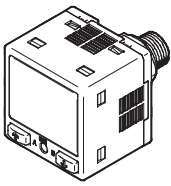
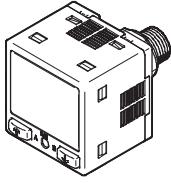
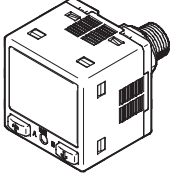

Technical data

Ordering data							
Version	Pressure measuring range [bar]	Electrical output		Electrical connection			
		Digital	Analogue	Cable ¹⁾		Plug	
				Part No.	Type	Part No.	Type
Pneumatic connection G$\frac{1}{8}$							
	-1 ... +1	1x PNP	1 ... 5 V	552 356	SPAB-B2R-G18-PB-K1	553 152	SPAB-B2R-G18-PB-M8
		2x PNP	-	552 350	SPAB-B2R-G18-2P-K1	553 146	SPAB-B2R-G18-2P-M8
		1x NPN	1 ... 5 V	552 359	SPAB-B2R-G18-NB-K1	553 155	SPAB-B2R-G18-NB-M8
		2x NPN	-	552 353	SPAB-B2R-G18-2N-K1	553 149	SPAB-B2R-G18-2N-M8
	0 ... 10	1x PNP	1 ... 5 V	552 368	SPAB-P10R-G18-PB-K1	553 164	SPAB-P10R-G18-PB-M8
		2x PNP	-	552 362	SPAB-P10R-G18-2P-K1	553 158	SPAB-P10R-G18-2P-M8
		1x NPN	1 ... 5 V	552 371	SPAB-P10R-G18-NB-K1	553 167	SPAB-P10R-G18-NB-M8
		2x NPN	-	552 365	SPAB-P10R-G18-2N-K1	553 161	SPAB-P10R-G18-2N-M8
Pneumatic connection R$\frac{1}{8}$							
	-1 ... +1	1x PNP	1 ... 5 V	552 357	SPAB-B2R-R18-PB-K1	553 153	SPAB-B2R-R18-PB-M8
		2x PNP	-	552 351	SPAB-B2R-R18-2P-K1	553 147	SPAB-B2R-R18-2P-M8
		1x NPN	1 ... 5 V	552 360	SPAB-B2R-R18-NB-K1	553 156	SPAB-B2R-R18-NB-M8
		2x NPN	-	552 354	SPAB-B2R-R18-2N-K1	553 150	SPAB-B2R-R18-2N-M8
	0 ... 10	1x PNP	1 ... 5 V	552 369	SPAB-P10R-R18-PB-K1	553 165	SPAB-P10R-R18-PB-M8
		2x PNP	-	552 363	SPAB-P10R-R18-2P-K1	553 159	SPAB-P10R-R18-2P-M8
		1x NPN	1 ... 5 V	552 372	SPAB-P10R-R18-NB-K1	553 168	SPAB-P10R-R18-NB-M8
		2x NPN	-	552 366	SPAB-P10R-R18-2N-K1	553 162	SPAB-P10R-R18-2N-M8
Pneumatic connection NPT$\frac{1}{8}$-27							
	-1 ... +1	1x PNP	1 ... 5 V	552 358	SPAB-B2R-N18-PB-K1	553 154	SPAB-B2R-N18-PB-M8
		2x PNP	-	552 352	SPAB-B2R-N18-2P-K1	553 148	SPAB-B2R-N18-2P-M8
		1x NPN	1 ... 5 V	552 361	SPAB-B2R-N18-NB-K1	553 157	SPAB-B2R-N18-NB-M8
		2x NPN	-	552 355	SPAB-B2R-N18-2N-K1	553 151	SPAB-B2R-N18-2N-M8
	0 ... 10	1x PNP	1 ... 5 V	552 370	SPAB-P10R-N18-PB-K1	553 166	SPAB-P10R-N18-PB-M8
		2x PNP	-	552 364	SPAB-P10R-N18-2P-K1	553 160	SPAB-P10R-N18-2P-M8
		1x NPN	1 ... 5 V	552 373	SPAB-P10R-N18-NB-K1	553 169	SPAB-P10R-N18-NB-M8
		2x NPN	-	552 367	SPAB-P10R-N18-2N-K1	553 163	SPAB-P10R-N18-2N-M8

1) Connecting cable NEBU-L1... (2.5 m long) included in scope of delivery.

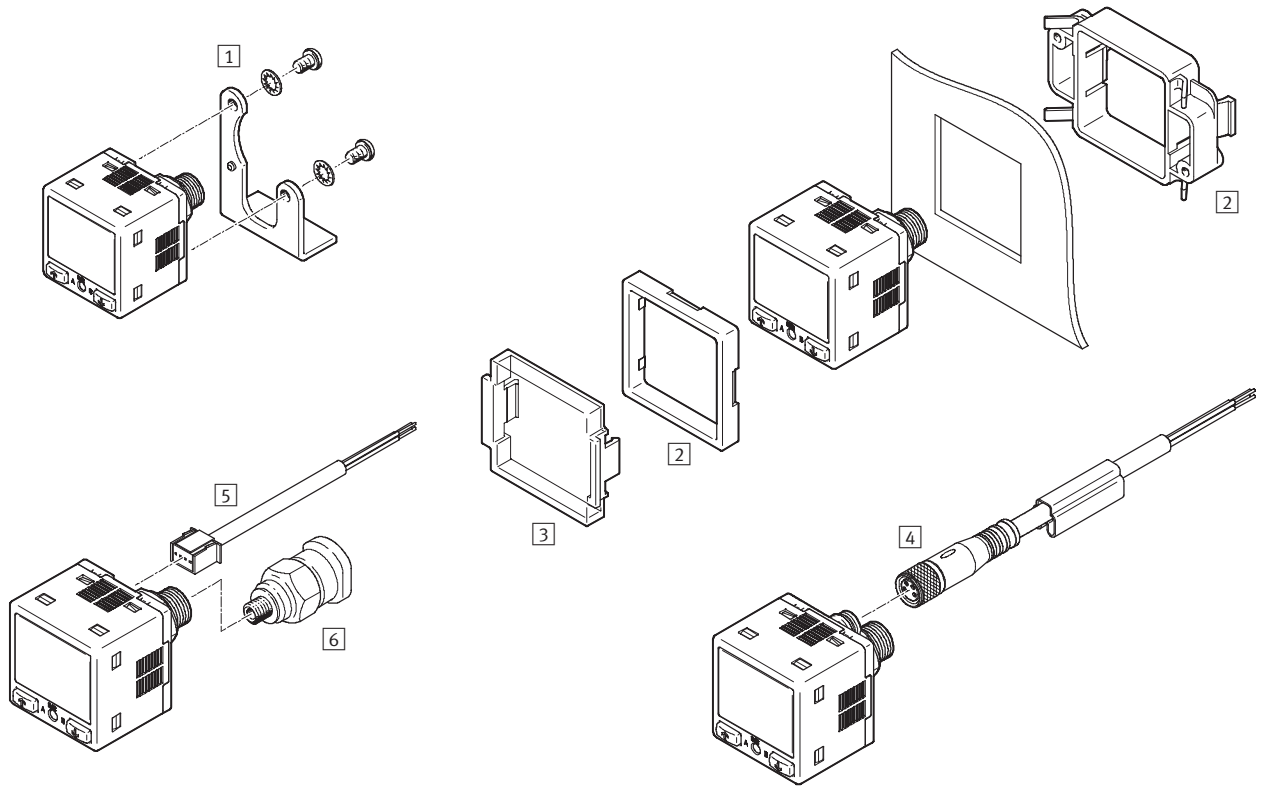

Pressure sensors SPAB, with display

Peripherals overview





Accessories	
1	Mounting bracket
2	Front panel installation kit
3	Safety guard

Accessories	
4	Connecting cable NEBU-M8...4
5	Connecting cable NEBU-L1G4 with square, straight socket
6	Push-in fitting QSM-M5

Ordering data – Connecting cables				Technical data → Internet: nebu	
	Number of cores	Cable length [m]	Part No.	Type	
M8x1, straight socket					
	4	2.5	541 342	NEBU-M8G4-K-2.5-LE4	
		5	541 343	NEBU-M8G4-K-5-LE4	
M8x1, angled socket					
	4	2.5	541 344	NEBU-M8W4-K-2.5-LE4	
		5	541 345	NEBU-M8W4-K-5-LE4	
Square, straight socket					
	4	2.5	552 374	NEBU-L1G4-K-2.5-LE4 ¹⁾	
		5	552 375	NEBU-L1G4-K-5-LE4	

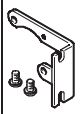
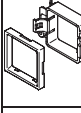
1) Included in the scope of delivery with SPAB-...-K1

Ordering data – Accessories			
	Description	Part No.	Type
	Mounting bracket	552 376	SAMH-P4-A
	Front panel installation kit	552 377	SAMH-P4-F
	Safety guard	552 378	SACC-P4-G

Ordering data – Push-in fittings				Technical data → Internet: quick star	
	Pneumatic connection	For tubing O.D. [mm]	Part No.	Type	
	M5	4	153 304	QSM-M5-4	
		6	153 306	QSM-M5-6	