

- Modular multi-functional valve terminal for up to 128 valves
- Design suitable for electrical peripherals CPX
- Channel-oriented diagnosis down to the individual valve
- Straightforward valve replacement
- Flow rate up to 360 l/min (MPA1)
- Flow rate up to 700 l/min (MPA2)
- Valves can be activated via electrical isolation, voltage tolerance  $\pm 25\%$

Specified types in accordance with ATEX directive for potentially explosive atmospheres  
→ [www.festo.com/en/ex](http://www.festo.com/en/ex)

## Valve terminals type 32 MPA

Key features

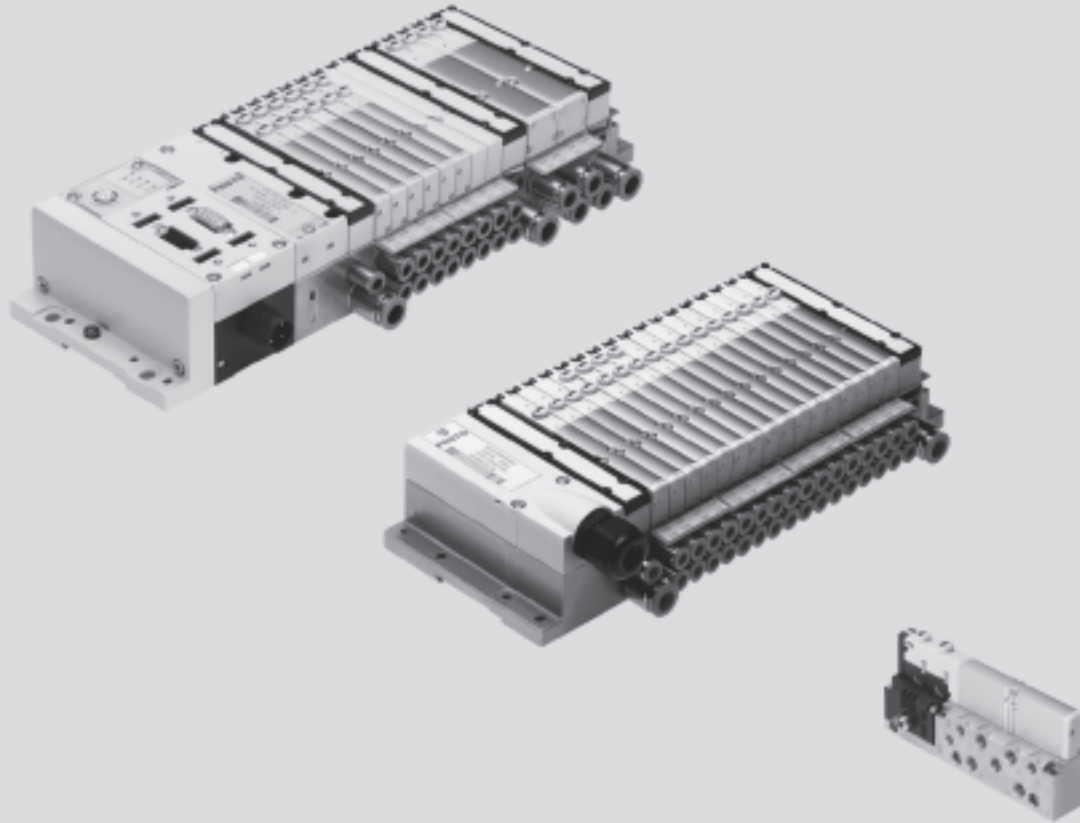

### Innovative

- Slim high-performance valves in sturdy metal housing
- MPA1 flow rate up to 360 l/min
- MPA2 flow rate up to 700 l/min
- From individual valve right through to a valve terminal with multi-pin plug, fieldbus connections or control block
- Dream team: Fieldbus valve terminal suitable for electrical peripherals CPX. This means
  - Advanced internal communication system for activation of the valves and CPX modules
  - Diagnosis down to the individual valve
  - Valves can either be activated via electrical isolation or without (standard)

### Versatile

- Modular system offering a range of configuration options
- Expandable up to 128 solenoid coils
- Can be converted and expanded at a later date
- Further manifold sub-bases can be assembled using just three screws and sturdy separating seals on metal separator plates
- Integration of innovative function modules possible
- Extendable air supply through additional pressure zones using supply plates
- Wide range of pressures –0.9 ... 10 bar
- Wide range of valve functions

### Reliable

- Sturdy and durable metal components
  - Valves
  - Manifold sub-bases
  - Seals
- Fast troubleshooting thanks to LEDs on the valves and diagnosis via fieldbus
- Extensive operating voltage range  $\pm 25\%$
- Ease of servicing through replaceable valves and electronics modules
- Manual override either pushing, detenting or secured against unauthorised activation (covered)
- Durable thanks to the use of tried-and-tested piston spool valves
- Large and durable labelling system, suitable for barcodes

### Easy to mount

- Ready-to-install unit, pre-assembled and tested
- Lower costs for selection, ordering, assembly and commissioning
- Secure wall mounting or H-rail mounting

# Valve terminals type 32 MPA

## Key features

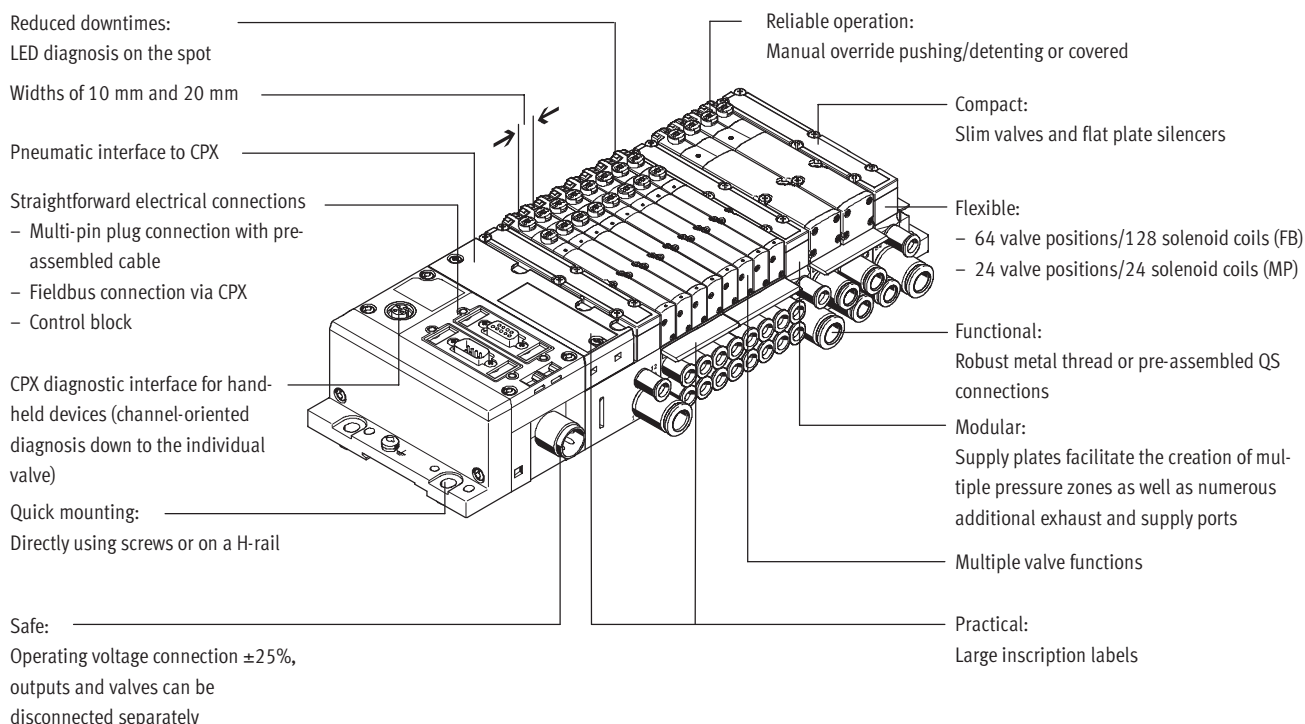

### Equipment options

#### Valve functions

- |  |  |   |  |
|--|--|---|--|
| <ul style="list-style-type: none"> <li>• 5/2-way valve, single solenoid</li> <li>• 5/2-way valve, double solenoid</li> <li>• 2x 3/2-way valve, normally open</li> <li>• 2x 3/2-way valve, normally closed</li> <li>• 2x 3/2-way valve, 1x normally open, 1x normally closed</li> </ul> | <ul style="list-style-type: none"> <li>• 5/3-way valve, mid-position pressurised</li> <li>• 5/3-way valve, mid-position closed</li> <li>• 5/3-way valve, mid-position exhausted</li> <li>• 2x 2/2-way valve, normally closed</li> <li>• 2 pressure supply ports</li> </ul> | <ul style="list-style-type: none"> <li>• 2x 2/2-way valve, normally closed</li> <li>• 1x 3/2-way valve, normally closed, external compressed air supply</li> <li>• 1x 3/2-way valve, normally open, external compressed air supply</li> </ul> | <p>All valves have the same compact dimensions with an overall length of 107 mm and a width of 10.5 mm or 21 mm as appropriate. A height of 55 mm makes them a perfect match for the electrical peripherals CPX.</p> |
|--|--|---|--|

#### Special features

- |  |   |   |  |
|--|---|---|--|
| <p><b>Multi-pin plug terminal</b></p> <ul style="list-style-type: none"> <li>• Max. 24 valve positions/ max. 24 solenoid coils</li> <li>• Parallel modular valve linking via circuit boards</li> <li>• Electronics module with integrated reduction of holding current</li> <li>• Any compressed air supply</li> <li>• Any number of pressure zones</li> </ul> | <p><b>Fieldbus terminal/control block</b></p> <ul style="list-style-type: none"> <li>• Max. 64 valve positions/ max. 128 solenoid coils</li> <li>• Internal CPX bus system for valve activation</li> <li>• Module for electrical valve activation, with or without electrical isolation</li> <li>• Any compressed air supply</li> <li>• Any number of pressure zones</li> </ul> | <p><b>Individual valve</b></p> <ul style="list-style-type: none"> <li>• Electrical M8 connection, 4-pin with screw connection</li> <li>• Detachable electronics module with integrated holding current reduction</li> </ul> | <p><b>Combinable</b></p> <ul style="list-style-type: none"> <li>• MPA1 flow rate up to 360 l/min</li> <li>• MPA2 flow rate up to 700 l/min</li> <li>• MPA1 and MPA2 can be combined on one valve terminal</li> </ul> |
|--|---|---|--|

#### Electrical supply plate

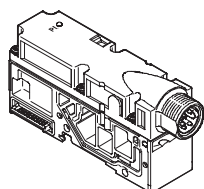

- Increases the maximum number of valve positions possible to 64, with max. 128 solenoid coils
- Facilitates the creation of electrically isolated, individually disconnectable voltage zones
- Greater economy thanks to the higher number of valves/solenoid coils per valve terminal
- Greater safety through individual disconnection of valve groups, for example for EMERGENCY-STOP functions

 Note

The electrical supply plate is available with either an M18 or 7/8" connection.

# Valve terminals type 32 MPA

Key features

## Valve terminal configurator

Online via: → [www.festo.com/en/engineering](http://www.festo.com/en/engineering)

A valve terminal configurator is available to help you select a suitable MPA valve terminal. This makes it much easier for you to find the right product.

The valve terminals are fully assembled according to your order specifications and individually tested. This reduces the amount of assembly and installation required to a minimum.

You order a valve terminal type 32 using the order code.

Ordering system for type 32

→ 4 / 2.2-42

Ordering system for CPX

→ [www.festo.com/catalogue/cpx](http://www.festo.com/catalogue/cpx)

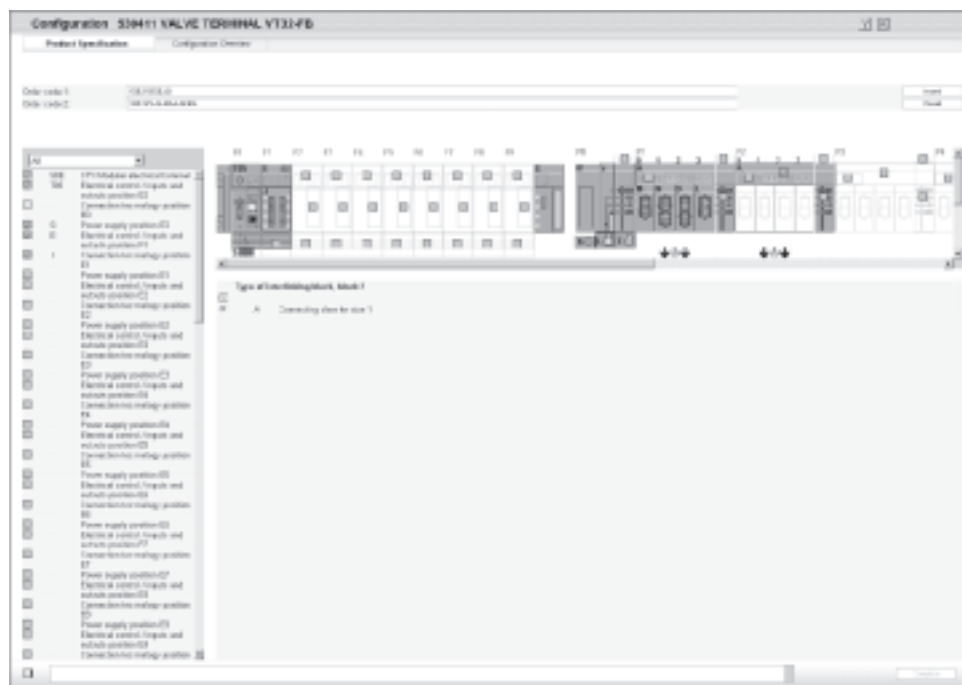

The illustration above provides an example of a valve terminal configuration.

The following steps explain how you arrive at the order code:

Once you have called up the Festo home page, select the online version of the digital product catalogue from the “Products” submenu: This will bring you directly to the home page for the Pneumatic Catalogue. Activate the “Direct Search” menu.

Here you can specify a “Part No.” (e.g. 539105 or 530411), the “Type” (e.g. VMPA) or “Article name” (e.g. valve terminal) to find your “Search result”. Click on the blue shopping basket to complete the selected product according to your specifications (this does not initiate an order).

You will then be prompted to configure the product. Select “Configurator”. You can then configure the valve terminal step by step (from the top down) according to your requirements. Select the “Finish” menu to continue on with the ordering process.

# Valve terminals type 32 MPA

Key features

## Individual connection

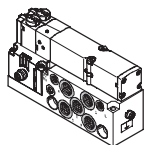

Valves can also be used on individual sub-bases for actuators situated remote from the valve terminal.

The electrical connection is established using a standard 4-pin M8 plug (VDMA 24 571).

## Multi-pin plug connection

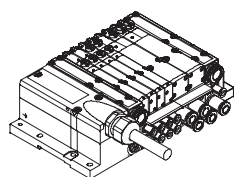

The signal flow from the controller to the valve terminal is transmitted to the multi-pin plug connection via a pre-assembled multi-core cable or a self-assembled cable, which substantially reduces installation time.

The valve terminals can be fitted with max. 24 solenoid coils. This corresponds to 4 to 24 MPA1 or 2 to 24 MPA2 valves, or a combination of both.

Variants

- Sub-D connection
- Pre-assembled multi-pin cable
- Multi-pin cable for self-assembly

## Fieldbus connection via the CPX system

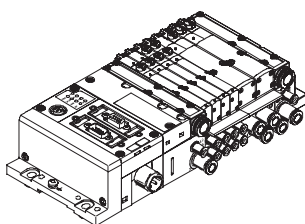

An integrated fieldbus node manages communication with a higher-order PLC. This enables a space-saving pneumatic and electronic solution.

Valve terminals with fieldbus interfaces can be configured with up to 16 manifold sub-bases. In conjunction with MPA1 and 8 solenoid coils per manifold sub-base, 128 solenoid coils can thus be actuated. With MPA2, 2 to 32 valves can be actuated.

Variants

- Profibus DP
- Interbus
- DeviceNet connection
- CANopen
- CC-Link
- Ethernet/IP
- Front End Controller Remote
- Front End Controller Remote I/O
- CPX terminal

➔ [www.festo.com/catalogue/cpx](http://www.festo.com/catalogue/cpx)

## Control block connection via the CPX system

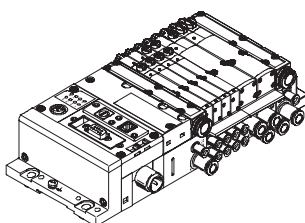

Controllers integrated in the Festo valve terminals permit the construction of stand-alone control units to IP65, without control cabinets.

Using the slave operation mode, these valve terminals can be used for intelligent pre-processing and are therefore ideal modules for configuring decentralised intelligence.

In master operation mode, terminal groups can be designed with many options and functions, which can autonomously control a medium-sized machine/system.

- CPX terminal

➔ [www.festo.com/catalogue/cpx](http://www.festo.com/catalogue/cpx)

# Valve terminals type 32 MPA

Peripherals overview



## Modular pneumatic components

The modular design of the MPA facilitates maximum flexibility right from the planning stage and offers maximum ease of service in operation.

The system consists of manifold sub-bases and valves. The manifold sub-bases are screwed together and thus form the support system for the valves.

Within the manifold sub-bases are the connection channels for supplying compressed air to and venting from the valve terminal as well as the working lines for the pneumatic drives for each valve.

Each manifold sub-base is connected to the next using three screws. Individual terminal sections can be isolated and further blocks inserted by loosening these screws. This ensures that the valve terminal can be rapidly and reliably expanded.

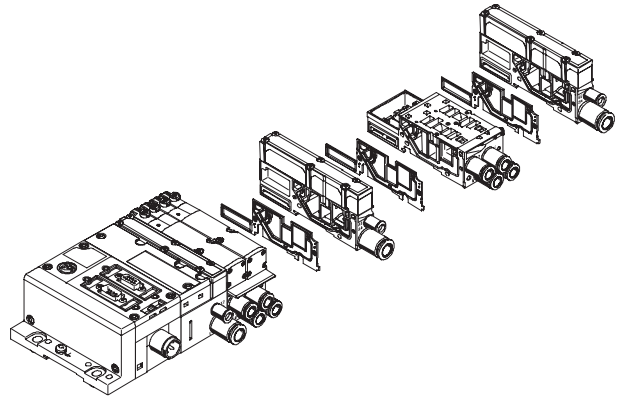
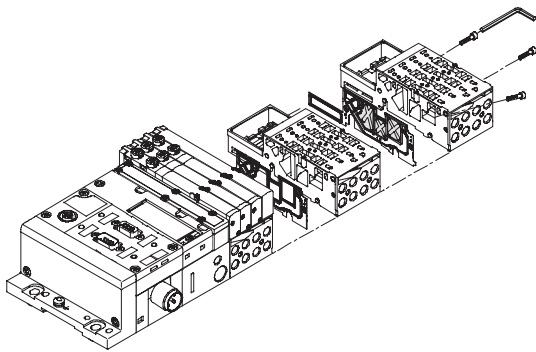

# Valve terminals type 32 MPA

Peripherals overview



## Modular electrical peripherals

The manner in which the valves are activated differs according to whether you are using a multi-pin terminal, fieldbus terminal or individual valve.

The MPA with CPX interface is based on the internal bus system of the CPX and uses this serial communication system for all solenoid coils and a range of electrical input and output functions.

Serial linking facilitates the following:

- Transmission of switching information
  - High valve density
  - Compact design
  - Position-based diagnosis
  - Separate voltage supply for valves
  - Flexible conversion without address shifting
  - Transmission of status, parameter and diagnostic data
- [www.festo.com/catalogue/cpx](http://www.festo.com/catalogue/cpx)

## MPA with electrical peripherals CPX

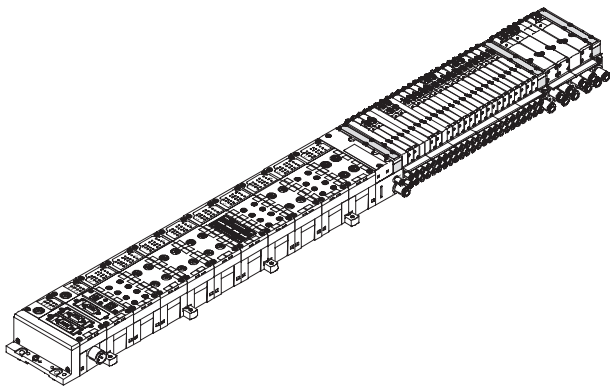

## Modularity with electrical peripherals CPX

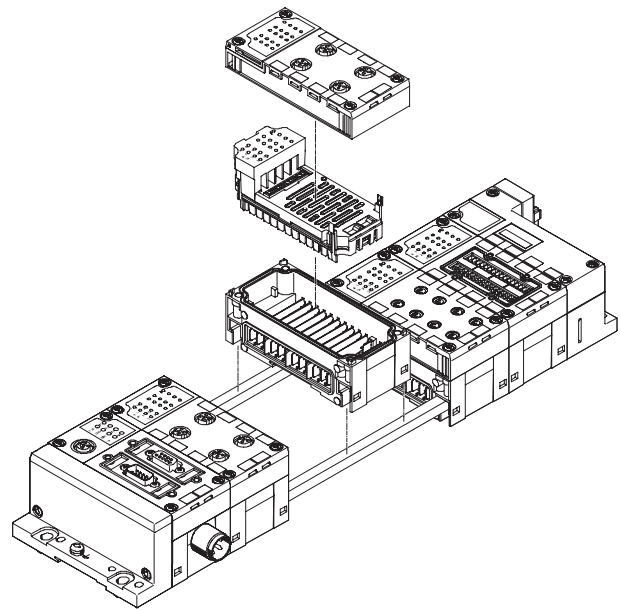

Valve terminals for standard applications  
Heavy-duty modular

2.2

# Valve terminals type 32 MPA

Peripherals overview

## Individual sub-base size 1

Order:

- Using individual part numbers

Individual sub-bases can be equipped with any valve.

The electrical connection is established using a standard 4-pin M8 plug (VDMA 24 571).

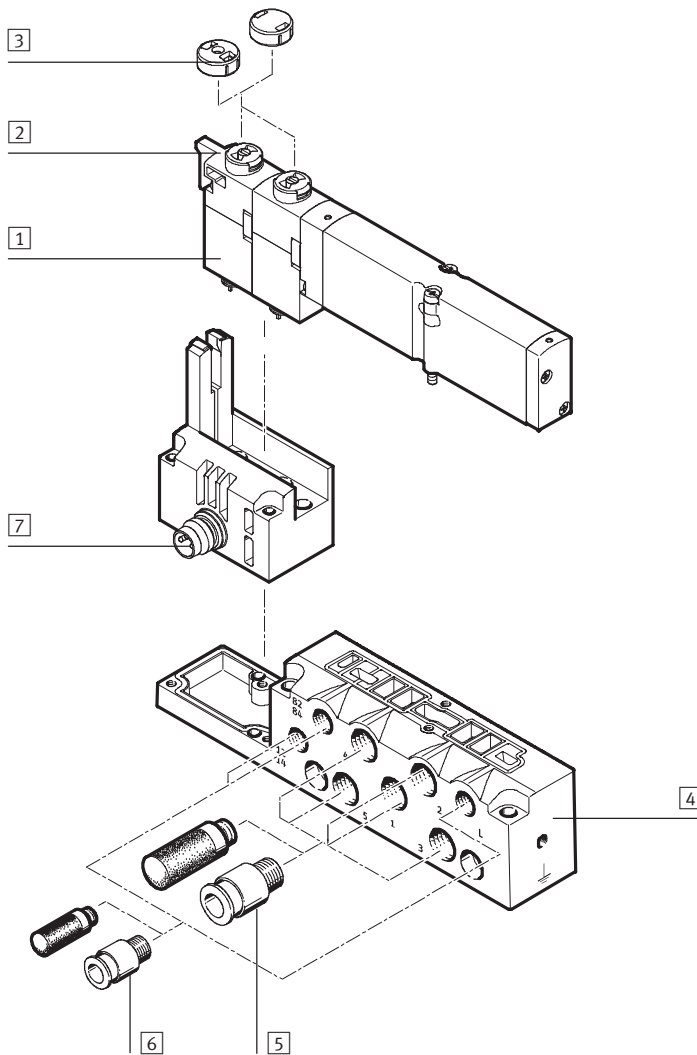

Designation	Brief description	→ Page
1 Solenoid valve	MPA1	4 / 2.2-50
2 Manual override	Pushing/turning with detent, per solenoid coil	–
3 Cover cap for manual override	Conversion from detenting/pushing to pushing or covered	4 / 2.2-52
4 Sub-base	For individual valve MPA1	4 / 2.2-51
5 Fittings and/or silencers	M7 for working ports (2, 4) and supply/exhaust ports (1, 3, 5)	4 / 2.2-53
6 Fittings, silencers or blanking plugs	M5 for pilot/exhaust air (12/14, 82/84) and pressure compensation	4 / 2.2-53
7 Electrical connection M8	4-pin	–



# Valve terminals type 32 MPA

Peripherals overview

## Individual sub-base size 2

Order:

- Using individual part numbers

Individual sub-bases can be equipped with any valve.

The electrical connection is established using a standard 4-pin M8 plug (VDMA 24571).

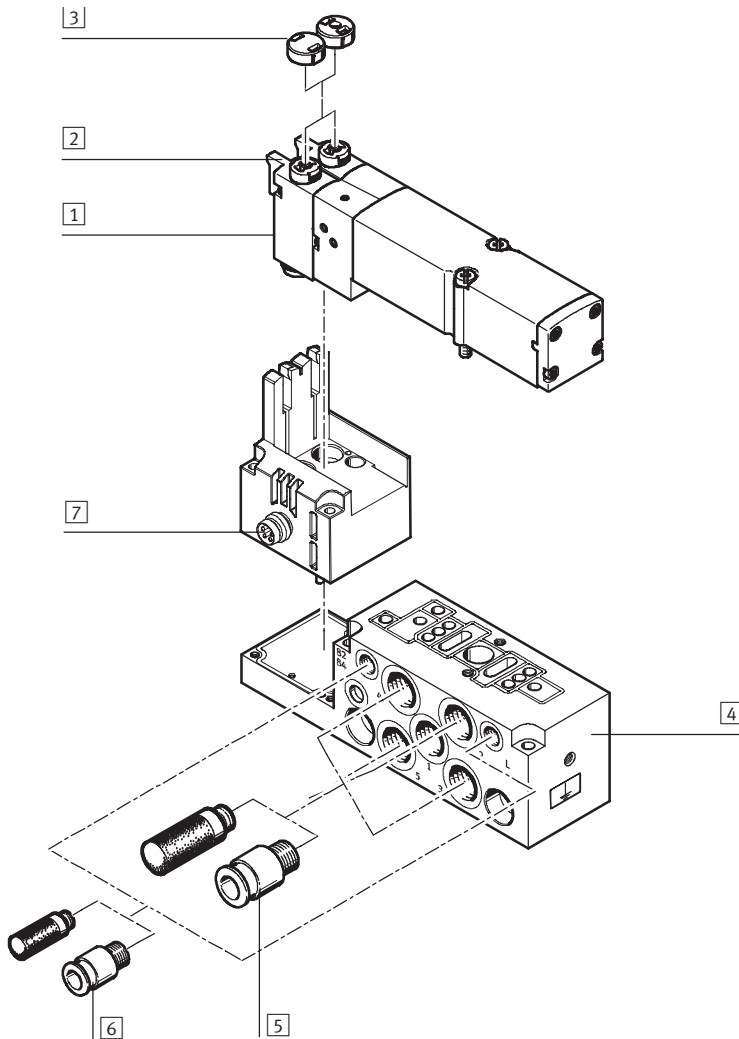

Designation	Brief description	→ Page
1 Solenoid valve	MPA2	4 / 2.2-50
2 Manual override	Pushing/turning with detent, per solenoid coil	–
3 Cover cap for manual override	Conversion from detenting/pushing to pushing or covered	4 / 2.2-52
4 Sub-base	For individual valve MPA2	4 / 2.2-51
5 Fittings and/or silencers G $\frac{1}{8}$	For working ports (2, 4) and supply/exhaust ports (1, 3, 5)	4 / 2.2-53
6 Fittings, silencers or blanking plugs M5	For pilot/exhaust air (12/14, 82/84) and pressure compensation	4 / 2.2-53
7 Electrical connection M8	4-pin	–

# Valve terminals type 32 MPA

Peripherals overview



## Valve terminal with multi-pin plug connection

Order code:

- 32P-... for the pneumatic components
- 32E-... for the electrical components

MPA valve terminals with multi-pin plug connection can be expanded with up to 24 solenoid coils.

The manifold sub-bases are either prepared for:

- 2 or 4 single solenoid valves
  - 2 or 4 double solenoid valves
- depending on the size.

- Double solenoid valve positions can be equipped with any valve or a blanking plate.
- Single solenoid valve positions can only be equipped with single solenoid valves.

The multi-pin plug connection is designed as a removable 25-pin Sub-D connection to IP65.

The cable can be selected when ordering:

- 2.5 m
- 5 m
- 10 m

Each can be used for max. 8 or 24 valves.

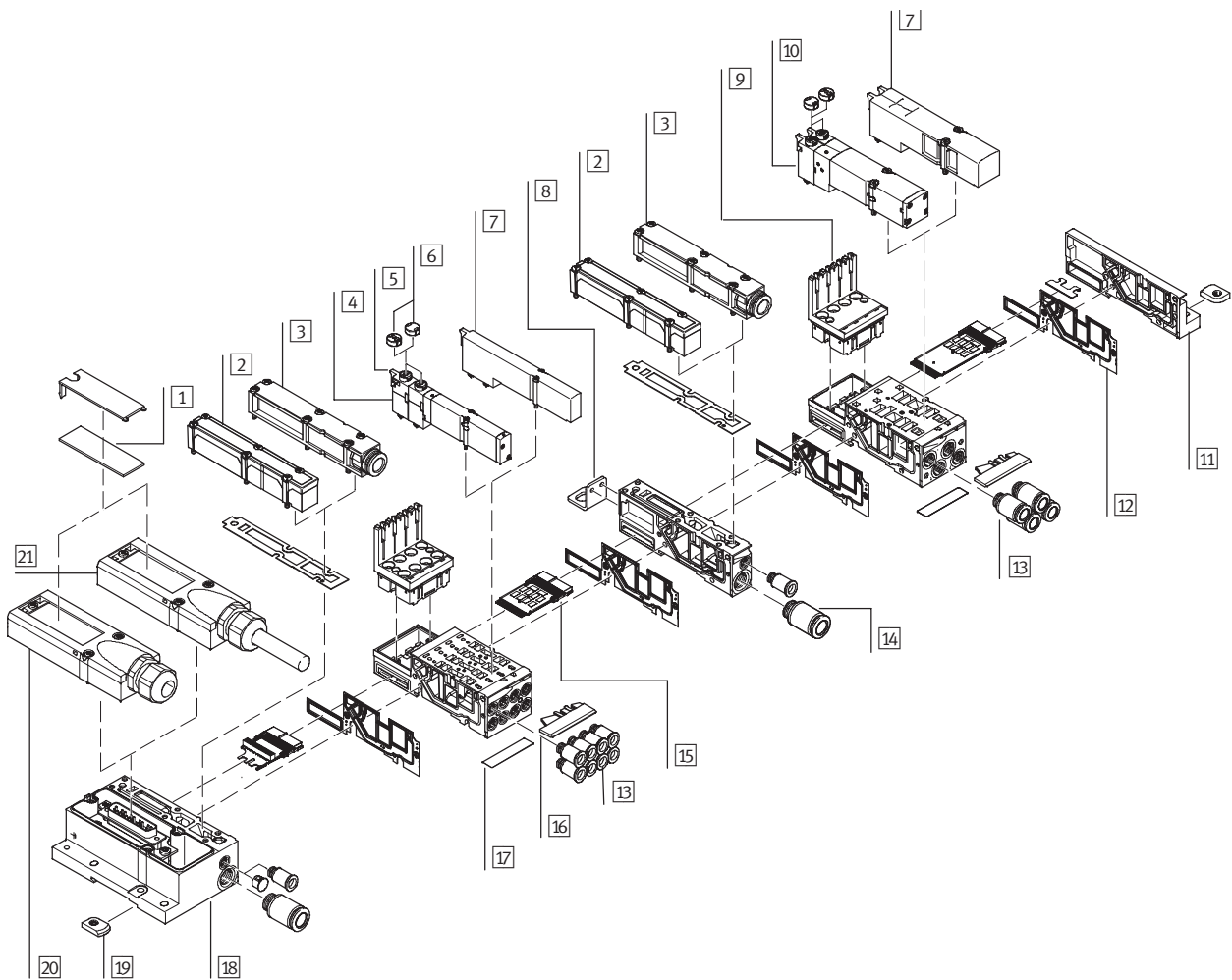

# Valve terminals type 32 MPA

Peripherals overview

FESTO

Valve terminal with multi-pin plug connection			
	Brief description	→ Page	
1	Inscription labels	Large, for multi-pin plug connection	–
2	Flat plate silencer	For pneumatic interface	–
3	Exhaust plate	For ducted exhaust air	4 / 2.2-52
4	Solenoid valve	Size 1	4 / 2.2-50
5	Manual override	Pushing/turning with detent, per solenoid coil	–
6	Cover cap for manual override	Conversion from detenting/pushing to pushing or covered	4 / 2.2-52
7	Blanking plate	For unused valve position (vacant position)	4 / 2.2-52
8	Mounting bracket	Optional for valve terminal mounting	4 / 2.2-51
9	Electronics module	For MPA1 and/or MPA2	4 / 2.2-51
10	Solenoid valve	Size 2	4 / 2.2-50
11	Right-hand end plate		4 / 2.2-51
12	Separating seal	For sub-base	4 / 2.2-52
13	Fittings	For working ports	4 / 2.2-53
14	Fittings	For pneumatic supply plate	4 / 2.2-53
15	Electrical interlinking module	For multi-pin plug connection, modular	4 / 2.2-52
16	Holder for inscription labels	For manifold sub-base	4 / 2.2-51
17	Inscription label		4 / 2.2-51
18	Electrical interface	For multi-pin plug	4 / 2.2-51
19	H-rail mounting		4 / 2.2-51
20	Multi-pin plug connection	For self-assembly	4 / 2.2-53
21	Multi-pin plug connection	With multi-pin cable	4 / 2.2-53

Valve terminals for standard applications  
Heavy-duty modular

2.2

# Valve terminals type 32 MPA

Peripherals overview



## Valve terminal with fieldbus connection, control block (electrical peripherals CPX)

Order code:

- 32P-... for the pneumatic components
- 50E-... for the electrical components

Valve terminals with fieldbus interfaces can be configured with up to 16 manifold sub-bases. In conjunction with MPA1 and 8 solenoid coils per manifold sub-base, 128 solenoid coils can thus be fitted.

Each valve position can be equipped with any valve or a blanking plate.

The rules for CPX apply to the equipment that can be used in combination with the electrical peripherals CPX.

In general:

- Max. 10 electrical modules
- Digital inputs/outputs

- Analogue inputs/outputs
- Parameterisation of inputs and outputs
- Integrated high-feature diagnostic system
- Preventive maintenance concepts

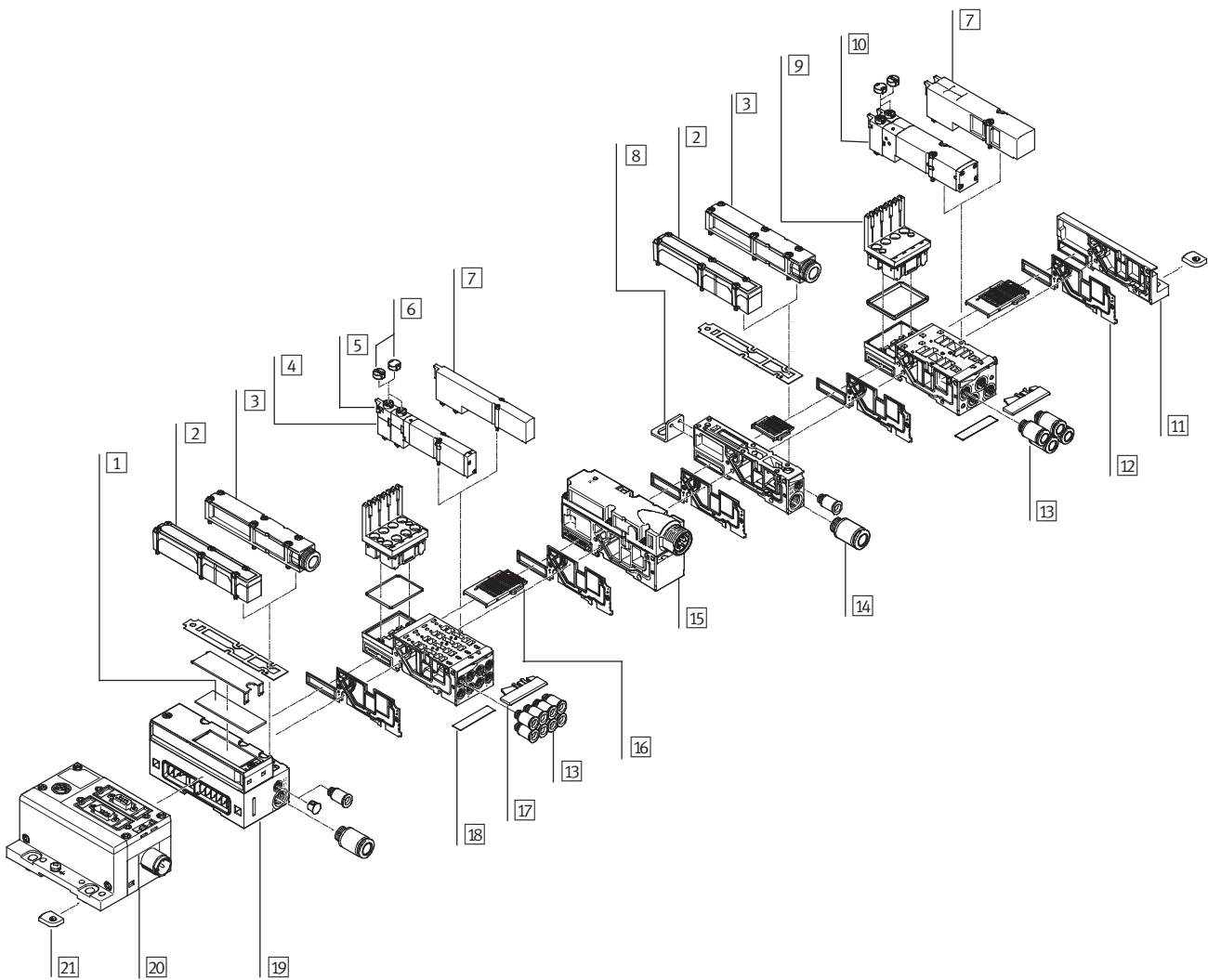

# Valve terminals type 32 MPA

Peripherals overview

Valve terminal with fieldbus connection, control block (electrical peripherals CPX)			
	Brief description	→ Page	
1	Inscription label	Large, for pneumatic interface CPX	–
2	Flat plate silencer	For pneumatic interface	–
3	Exhaust plate	For ducted exhaust air	4 / 2.2-52
4	Solenoid valve	For size 1	4 / 2.2-50
5	Manual override	Pushing/turning with detent, per solenoid coil	–
6	Cover cap for manual override	Conversion from detenting/pushing to pushing or covered	4 / 2.2-52
7	Blanking plate	For unused valve position (vacant position)	4 / 2.2-52
8	Mounting bracket	Optional for valve terminal mounting	4 / 2.2-51
9	Electronics module	For MPA1 and/or MPA2	4 / 2.2-51
10	Solenoid valve	Size 2	4 / 2.2-50
11	Right-hand end plate		4 / 2.2-51
12	Separating seal	For sub-base	4 / 2.2-52
13	Fittings	For working ports	4 / 2.2-53
14	Fittings	For pneumatic supply plate	4 / 2.2-53
15	Electrical supply plate	For auxiliary voltage supply for large valve terminals	4 / 2.2-51
16	Electrical interlinking module	For fieldbus connection	4 / 2.2-52
17	Holder for inscription labels	For manifold sub-base	4 / 2.2-51
18	Inscription label		4 / 2.2-51
19	Pneumatic interface	For CPX modules	4 / 2.2-51
20	CPX module		–
21	H-rail mounting		4 / 2.2-51

# Valve terminals type 32 MPA

Key features – Pneumatic components



## Sub-base valve

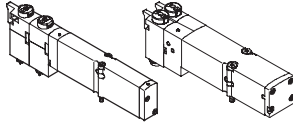

MPA offers a comprehensive range of valve functions. All valves are equipped with piston spool and patented sealing system which facilitates efficient sealing, a broad pressure range and long service life. To increase power they have a pneumatic pilot control supplied by pilot air.

Sub-base valves can be quickly replaced since the tubing connection remains on the sub-base. This design is also particularly slim.

Irrespective of the valve function there are sub-base valves with one solenoid coil (single solenoid) or with two solenoid coils (double solenoid or two single solenoid valves in one housing).

## Constructional design

### Valve replacement

The valves are attached to the metal manifold sub-base using two screws. This means that they can be easily

replaced. The mechanical robustness of the manifold sub-base guarantees good long-term sealing tightness.

### Expansion

Blanking plates can be replaced by valves at a later date. The dimensions, mounting points and existing pneumatic installations remain unchanged

during this process. The valve code (M, J, N, K, H, B, G, E, X, W, D, I) is located on the front of the valve beneath the manual override.

## Valve function

Code	Circuit symbol	Size		Description
		1	2	
M		■	■	5/2-way valve, single solenoid <ul style="list-style-type: none"> <li>• Pneumatic spring return</li> <li>• Reversible</li> <li>• Suitable for vacuum</li> </ul>
J		■	■	5/2-way valve, double solenoid <ul style="list-style-type: none"> <li>• Double solenoid</li> <li>• Reversible</li> <li>• Suitable for vacuum</li> </ul>
N		■	■	2x 3/2-way valve, single solenoid <ul style="list-style-type: none"> <li>• Normally open</li> <li>• Pneumatic spring return</li> <li>• Operating pressure &gt; 3 bar</li> </ul>
K		■	■	2x 3/2-way valve, single solenoid <ul style="list-style-type: none"> <li>• Normally closed</li> <li>• Pneumatic spring return</li> <li>• Operating pressure &gt; 3 bar</li> </ul>
H		■	■	2x 3/2-way valve, single solenoid <ul style="list-style-type: none"> <li>• Normal position                             <ul style="list-style-type: none"> <li>– 1x closed</li> <li>– 1x open</li> </ul> </li> <li>• Pneumatic spring return</li> <li>• Operating pressure &gt; 3 bar</li> </ul>

# Valve terminals type 32 MPA

Key features – Pneumatic components



Valve function				
Code	Circuit symbol	Size		Description
		1	2	
B		■	■	5/3-way valve <ul style="list-style-type: none"> <li>• Mid-position pressurised<sup>1)</sup></li> <li>• Spring force return</li> <li>• Reversible</li> <li>• Suitable for vacuum</li> </ul>
G		■	■	5/3-way valve <ul style="list-style-type: none"> <li>• Mid-position closed<sup>1)</sup></li> <li>• Spring force return</li> <li>• Reversible</li> <li>• Suitable for vacuum</li> </ul>
E		■	■	5/3-way valve <ul style="list-style-type: none"> <li>• Mid-position exhausted<sup>1)</sup></li> <li>• Spring force return</li> <li>• Reversible</li> <li>• Suitable for vacuum</li> </ul>
X		■	■	1x 3/2-way valve, single solenoid <ul style="list-style-type: none"> <li>• Normally closed</li> <li>• External compressed air supply</li> <li>• Pneumatic spring return</li> <li>• Reversible</li> </ul> Compressed air (–0.9 ... +10 bar) supplied at working port 4 can be switched whether using either internal or external pilot air.
W		■	■	1x 3/2-way valve, single solenoid <ul style="list-style-type: none"> <li>• Normally open</li> <li>• External compressed air supply</li> <li>• Pneumatic spring return</li> <li>• Reversible</li> </ul> Compressed air (–0.9 ... +10 bar) supplied at working port 2 can be switched whether using either internal or external pilot air.
D		■	■	2x 2/2-way valve <ul style="list-style-type: none"> <li>• Normally closed</li> <li>• Pneumatic spring return</li> <li>• Operating pressure &gt; 3 bar</li> </ul>
I		■	■	2x 2/2-way valve <ul style="list-style-type: none"> <li>• Normally closed</li> <li>• Pneumatic spring return</li> <li>• Operating pressure &gt; 3 bar</li> <li>• Vacuum at port 3/5 only</li> </ul>

1) If neither solenoid coil is being supplied with power, the valve assumes its mid-position by means of spring force.  
If both coils are being supplied with power simultaneously, the valve remains in the switching position previously assumed.

# Valve terminals type 32 MPA

Key features – Pneumatic components



## Blanking plate

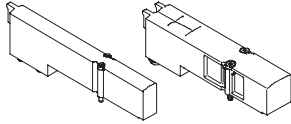

Plate without valve function for reserving valve positions on a valve terminal.

Valves and blanking plates are attached to the manifold block using two screws.

## Valve function

Code	Circuit symbol	Size		Description
		1	2	
L		■	■	For valve terminal only: Blanking plate for vacant valve position

## Compressed air supply and venting

### Pneumatic interface

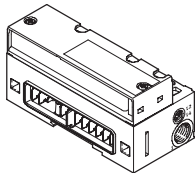

The valve terminal MPA can be supplied with air at one or more points. This is a reliable way of ensuring that the terminal will always have a sufficient supply of air and that this air will be vented, even with large-scale expansions.

The main supply to the terminal is located on the pneumatic interface, which links the electrical and the pneumatic parts. Additional provision is made for a number of supply plates. Venting is performed either using flat plate silencers or common lines for ducted exhaust.

These vents are located on the pneumatic interface as well as on the supply plates. In the case of ducted exhaust, at least one additional supply plate is required which then contains the exhaust port for the pilot air (port 82/84).

### Supply plate

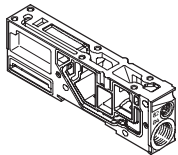

## Pilot air

The port for the main pneumatic supply is located on the pneumatic interface.

The ports differ for the following types of pilot air:

- Internal
- External

### Internal pilot air

Internal pilot air can be selected if the required working pressure is between 3 and 8 bar.

The pilot air is then branched from the compressed air supply 1 in the pneumatic interface using an internal connection. The port 12/14 is closed using a blanking plug.

### External pilot air

If the supply pressure is less than 3 bar or greater than 8 bar, you must operate your MPA valve terminal using external pilot air. In this case the pilot air is additionally supplied via port 12/14 at the pneumatic interface.



Note

If a gradual pressure build-up in the system using a pressurised on-off valve is chosen, external pilot air should be connected so that the control pressure applied during switch-on is already very high.



# Valve terminals type 32 MPA

Key features – Pneumatic components



Valve terminals for standard applications  
Heavy-duty modular

2.2

Compressed air supply and pilot air					
Code	Graphical symbol		Size		Notes
	Type of compressed air supply and pilot air				
	Pneumatic interface	Supply plate	1	2	
S			■	■	Internal pilot air, flat plate silencer <ul style="list-style-type: none"> <li>Pilot air is branched internally from port 1 in the pneumatic interface</li> <li>Exhaust port 3/5 and pilot exhaust port 82/84 via flat plate silencer</li> <li>For operating pressure in the range 3 ... 8 bar</li> </ul>
T			■	■	External pilot air, flat plate silencer <ul style="list-style-type: none"> <li>Pilot air between 3 and 8 bar is connected at port 12/14</li> <li>Exhaust port 3/5 and pilot exhaust port 82/84 via flat plate silencer</li> <li>For operating pressure in the range -0.9 ... 10 bar (suitable for vacuum)</li> </ul>
V			■	■	Internal pilot air, ducted exhaust air <ul style="list-style-type: none"> <li>Pilot air is branched internally from port 1 in the pneumatic interface</li> <li>Exhaust port 3/5: Connection to pneumatic interface and supply plate</li> <li>Pilot exhaust port 82/84: Connection to supply plate only</li> <li>For operating pressure in the range 3 ... 8 bar</li> </ul>
X			■	■	External pilot air, ducted exhaust air <ul style="list-style-type: none"> <li>Pilot air (3 ... 8 bar) is connected at port 12/14</li> <li>Exhaust port 3/5: Connection to pneumatic interface and supply plate</li> <li>Pilot exhaust port 82/84: Connection to supply plate only</li> <li>For operating pressure in the range -0.9 ... 10 bar (suitable for vacuum)</li> </ul>

Pneumatic interface					
Code	Pneumatic interface design variants		Size		Notes
	Graphical symbol				
	Graphical symbol	Type	1	2	
M		VMPA...-EPL...	■	■	<ul style="list-style-type: none"> <li>Used together with compressed air supply S, T, V, X</li> <li>The pilot exhaust air must be vented at least at one supply plate when using V or X. In the case of multiple supply plates, the port 82/84 is open on the last supply plate ex-works.</li> </ul>

# Valve terminals type 32 MPA

Key features – Pneumatic components



Valve terminals for standard applications  
Heavy-duty modular

2.2

## Supply plate

Additional supply plates can be used for larger terminals or to create pressure zones.

If several valves are operated simultaneously at full flow rate, it is recommended that a supply plate be positioned after every 8 valves (MPA1) or 4 valves (MPA2) as the case may be.

### MPA with CPX

Supply plates can be configured at any point before or after manifold sub-bases.

### MPA with MPM connection (modular multi-pin plug)

Supply plates can be configured at any point before or after manifold sub-bases.

### MPA with ducted exhaust air

At least one supply plate via which the exhaust port 82/84 is vented is mandatory with ducted exhaust air.

Supply plates contain the ports:

- Compressed air supply (1)
- Venting of the pilot air (82/84) and pressure compensation
- Exhaust air (3/5)

Depending on your order, the exhaust air channels are either ducted or vented via the flat plate silencer.

The supply plate is configured using the code letter U if no directly adjoining separating seal is required.

If a separating seal (S, T or R) is selected to the direct right or left of the supply plate, then the code letter V or W identifies the position of the left-hand or right-hand separating seal. The code for the separating seal (S, T or R) is placed in front of the code for the supply plate (V or W).

Supply plate					
Code <sup>1)</sup>	Graphical symbol	Type	Size		Notes
			1	2	
U		VMPA1-...-SP...	■	■	Supply plate without separating seal (no R, S or T selected)
V		VMPA1-...-SP...	■	■	Supply plate with separating seal on left, if R, S or T selected
W		VMPA1-...-SP...	■	■	Supply plate with separating seal on right, if R, S or T selected

1) The supply plate is equipped with silencer or exhaust plate depending on the code for the air supply S, T, V, X.

# Valve terminals type 32 MPA

Key features – Electrical components



## Electrical supply plate

Additional electrical supply plates can be used for large terminals. This enables up to 64 valve positions/128 solenoid coils to be supplied.

### MPA with CPX

Electrical supply plates can be configured at any point before or after manifold sub-bases.

### MPA with MPM connection (modular multi-pin plug)

The restriction to 12 valve positions/24 solenoid coils means that no electrical supply plates are needed.



Note

Please note that only electronics modules with electrical isolation are permitted to the right of the electrical supply plate. The electrical supply plate must not be installed directly left of a pneumatic supply plate (type VMPA1-FB-SP..).

## Electrical supply plate

Code	Graphical symbol	Type	Size		Notes
			1	2	
L		VMPA-FB-SP-V-SP	■	■	Electrical supply plate with M18 plug connection, 3-pin
		VMPA-FB-SP-7/8-V-5POL	■	■	Electrical supply plate with 7/8" plug connection, 5-pin
		VMPA-FB-SP-7/8-V-4POL	■	■	Electrical supply plate with 7/8" plug connection, 4-pin

## Pin allocation for voltage supply

	Pin	Allocation
<b>Pin allocation for M18</b>		
	2	24 V DC valves
	3	0 V DC
	4	FE (earth)
<b>Pin allocation for 7/8", 5-pin</b>		
	1	0 V DC valves
	2	n.c.
	3	FE (leading)
	4	n.c.
	5	24 V DC valves
<b>Pin allocation for 7/8", 4-pin</b>		
	A	n.c.
	B	24 V DC valves
	C	FE (earth)
	D	0 V DC valves (leading)

# Valve terminals type 32 MPA

Key features – Pneumatic components

## Creation of pressure zones and separation of exhaust air

MPA offers a number of options for creating pressure zones if different working pressures are required. Pressure zones are created by isolating the internal supply ducts in the manifold sub-bases using an appropriate separating seal or using a separator that is firmly incorporated in the manifold sub-base (code I).

Compressed air is supplied and vented via a supply plate. The position of the supply plates and separating seals can be freely selected for MPA with CPX and MPM (multi-pin plug).

Separating seals are integrated ex-works as per your order. Separating seals can be distinguished through their coding, even when the valve terminal is assembled.

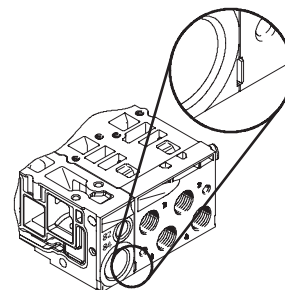

Note

The following must be taken into consideration with subsequent expansion or conversions:

Operation with ducted exhaust air and operation with flat plate silencers requires different separating seals.

### Creation of pressure zones

Code	Separating seal for operation with flat plate silencer		Separating seal for operation with ducted exhaust air		Size		Notes
	Graphical examples	Coding	Graphical examples	Coding	1	2	
-					■	■	No duct separation
T					■	■	Duct 1 separated
S					■	■	Duct 1 and 3/5 separated
R					■	■	Duct 3/5 separated
Code	Duct separation in manifold sub-base for operation with flat plate silencer or with ducted exhaust air			Size		Notes	
	Graphical examples		Coding	1	2		
I			-	■	■	Duct 1 separated	

Note

Duct separation in the manifold sub-base is performed in the centre of the manifold block

(between valve 2 and 3 with MPA1, or between valve 1 and 2 with MPA2).

# Valve terminals type 32 MPA

Key features – Pneumatic components



## Examples: Compressed air supply and pilot air

### Internal pilot air, flat plate silencer

Pneumatic valve terminal supply:  
Code S

The diagram opposite shows an example for the configuration and connection of the air supply in the case of internal pilot air. Port 12/14 on the pneumatic interface or the electrical interface (multi-pin plug) as appropriate is tightly sealed. Ports 3/5 and 82/84 are drawn off via the flat plate silencer. Port 82/84 is tightly sealed. Separating seals can be used optionally to create pressure zones.

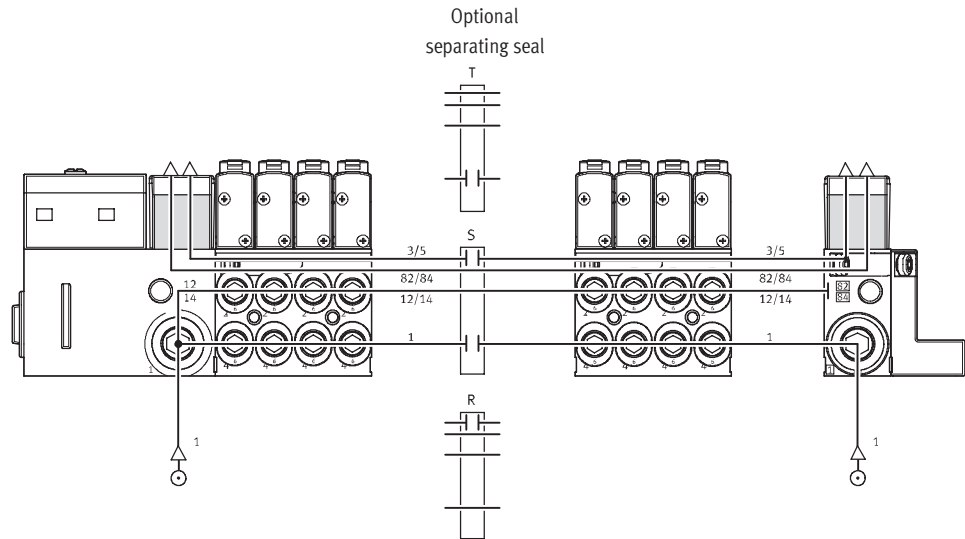

### External pilot air, flat plate silencer

Pneumatic valve terminal supply:  
Code T

The diagram opposite shows an example for the configuration and connection of the compressed air supply with external pilot air. Port 12/14 on the pneumatic interface/electrical interface (multi-pin plug) is equipped with a threaded connector for this purpose. Ports 3/5 and 82/84 are drawn off via the flat plate silencer. Port 82/84 is tightly sealed. Separating seals can be used optionally to create pressure zones.

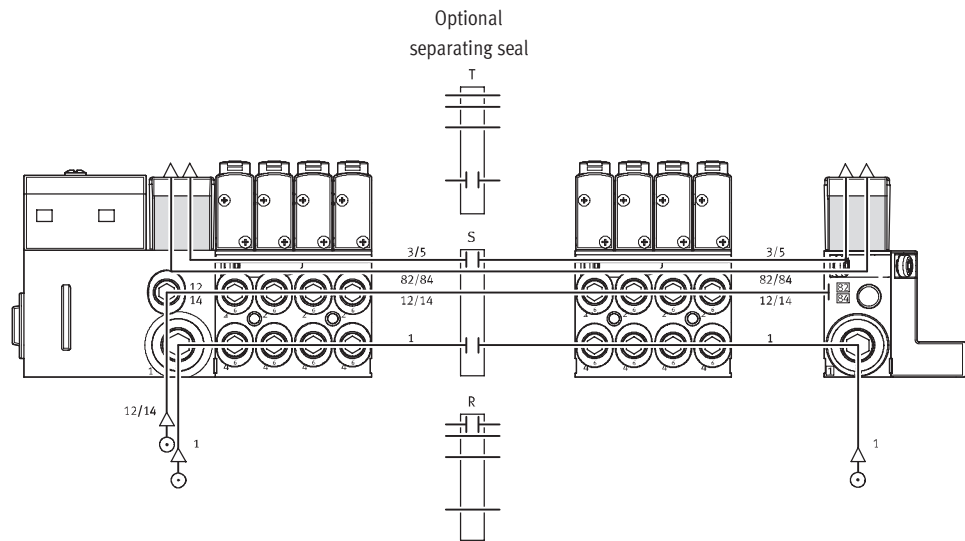

# Valve terminals type 32 MPA

Key features – Pneumatic components



## Examples: Compressed air supply and pilot air

### Internal pilot air, ducted exhaust air

Pneumatic valve terminal supply:  
Code V

The diagram opposite shows an example for the configuration and connection of the compressed air supply with internal pilot air. Port 12/14 on the pneumatic interface/electrical interface (multi-pin plug) is tightly sealed. Ports 3/5 and 82/84 are drawn off via the appropriate connections. Separating seals can be used optionally to create pressure zones.

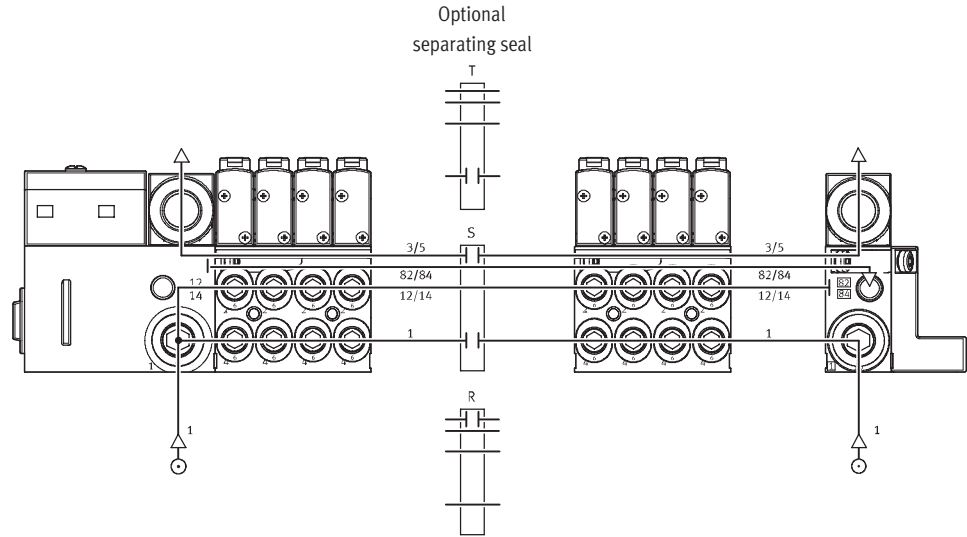

### External pilot air, ducted exhaust air

Pneumatic valve terminal supply:  
Code X

The diagram opposite shows an example for the configuration and connection of the compressed air supply with external pilot air. Port 12/14 on the pneumatic interface/electrical interface (multi-pin plug) is equipped with a threaded connector for this purpose. Ports 3/5 and 82/84 are drawn off via the appropriate connections. Separating seals can be used optionally to create pressure zones.

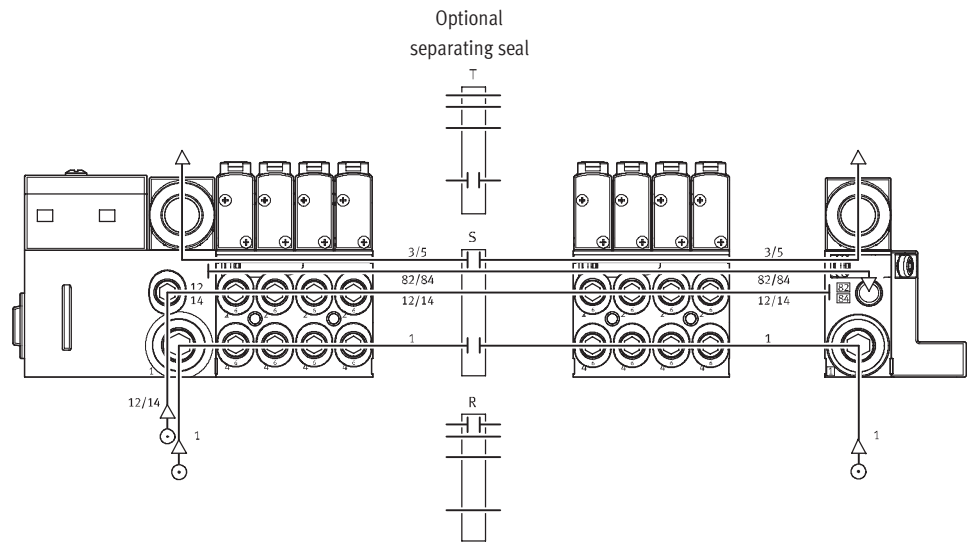

# Valve terminals type 32 MPA

Key features – Pneumatic components



## Examples: Creation of pressure zones MPA with CPX terminal connection

MPA allows the creation of up to 8 pressure zones. The diagram shows an example for the configuration and connection of three pressure zones using separating seals – with external pilot air.

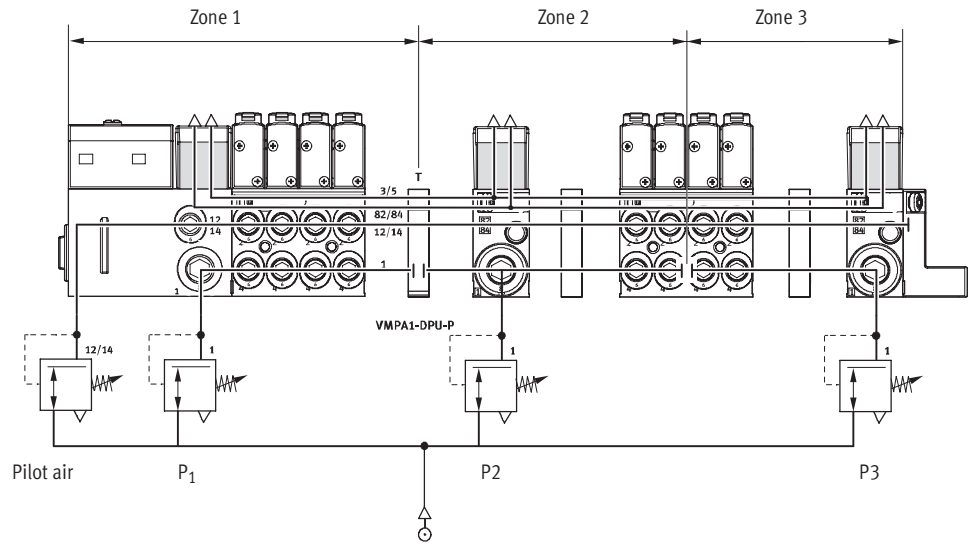

## MPA with multi-pin plug connection

This design facilitates the creation of up to 12 pressure zones. The diagram shows an example for the configuration and connection of the pressure zones – with external pilot air.

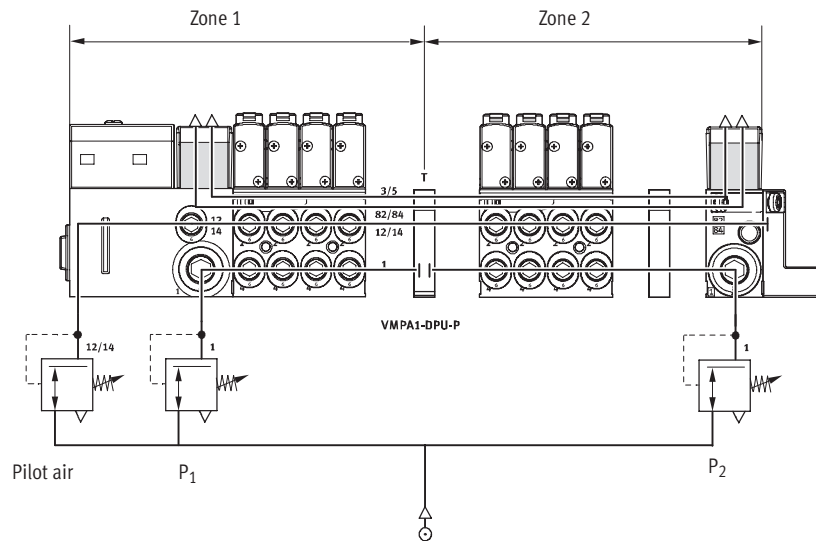

# Valve terminals type 32 MPA

Key features – Pneumatic components



## Examples: Creation of pressure zones

### Manifold block with pressure zone separation

Another way of creating pressure zones is to use manifold sub-bases with pressure zone separation. Only duct 1 is separated here however.

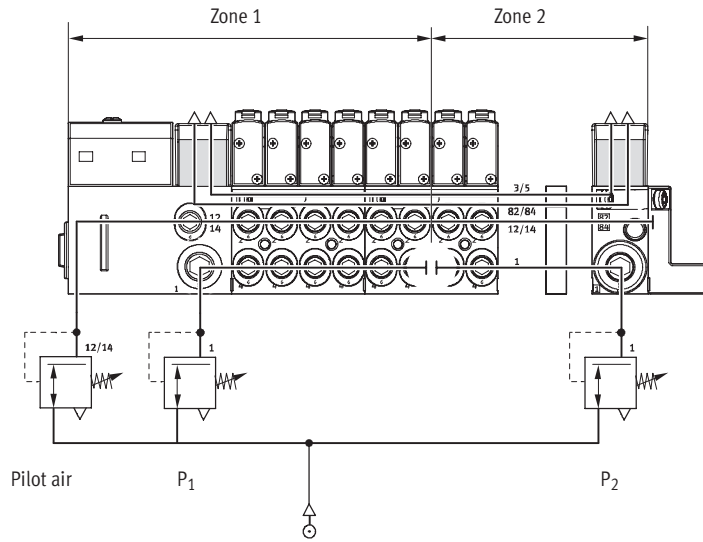



# Valve terminals type 32 MPA

Key features – Pneumatic components



## Manifold sub-base

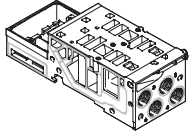

MPA is based on a modular system which consists of manifold sub-bases and valves. The manifold sub-bases are screwed together and thus form the support system for the valves. Within the manifold sub-bases are

the connection channels for supplying compressed air to and venting from the valve terminal as well as the working lines for the pneumatic drives for each valve. Each manifold sub-base is connected

to the next using three screws. Individual terminal sections can be isolated and further blocks inserted by loosening these screws. This ensures that the valve terminal can be rapidly and reliably expanded.

## Manifold sub-base variants

Code	Graphical symbol	Type	Size		Number of valve positions (solenoid coils)	Notes
			1	2		
<b>Manifold sub-base for multi-pin plug/fieldbus connection</b>						
A, C* Al, Cl*		VMPA1-FB-AP-4-1 VMPA1-FB-AP-4-1-T1 (code I)	■	–	4 (8/4*)	Working ports (2, 4) on the manifold sub-base <ul style="list-style-type: none"> <li>• Connection sizes: MPA1: M7, QS4, QS6</li> <li>• Code I: Separation in duct 1 in the manifold sub-base</li> </ul>
B, D* Bl, Dl*		VMPA2-FB-AP-2-1 VMPA2-FB-AP-2-1-TO (code I)	–	■	2 (4/2*)	Working ports (2, 4) on the manifold sub-base <ul style="list-style-type: none"> <li>• Connection sizes MPA2: G1/8, QS6, QS8</li> <li>• Code I: Separation in duct 1 in the manifold sub-base</li> </ul>
<b>Individual sub-base</b>						
–		<b>Without ATEX approval:</b> VMPA1-1-IC-AP-1** VMPA1-1-IC-AP-S-1*** <b>With ATEX approval:</b> VMPA1-1-IC-AP-1-EX1** VMPA1-1-IC-AP-S-1-EX1***	■	–	1 (2)	<ul style="list-style-type: none"> <li>• With working ports MPA1: M7, QS4, QS6</li> <li>• With ports for supply air (1, 12/14) and exhaust air (3, 5, 82/84)</li> <li>• For internal or external pilot air</li> </ul>
–		<b>Without ATEX approval:</b> VMPA2-IC-AP-1** VMPA2-IC-AP-S-1*** <b>With ATEX approval:</b> VMPA2-IC-AP-1-EX1** VMPA2-IC-AP-S-1-EX1***	–	■	1 (2)	<ul style="list-style-type: none"> <li>• With working ports MPA2: G1/8, QS6, QS8</li> <li>• With ports for supply air (1, 12/14) and exhaust air (3, 5, 82/84)</li> <li>• For internal or external pilot air</li> </ul>

\* Only possible with multi-pin plug connection

\*\* Internal pilot air

\*\*\* External pilot air

# Valve terminals type 32 MPA

Key features – Pneumatic components



Valve terminals for standard applications  
Heavy-duty modular

2.2

Electrical interface variants						
Code	Graphical symbol	Type	Size		Number of valve positions (solenoid coils)	Notes
			1	2		
Electronics module for multi-pin plug (MPM)						
A, B, C, D		VMPA1-MPM-EMM-8 VMPA1-MPM-EMM-4	■	–	4 (8) 4 (4)	Each valve solenoid coil must be assigned to a specific pin of the multi-pin plug in order for valve actuation to take place. Regardless of the blanking plates or valves equipped, valve positions occupy <ul style="list-style-type: none"> <li>• 1 address for actuation of 1 coil</li> <li>• 2 addresses for actuation of 2 coils</li> </ul>
		VMPA2-MPM-EMM-4 VMPA2-MPM-EMM-2	–	■	2 (4) 2 (2)	
Electronics module for fieldbus						
A, B, H		VMPA...-FB-EMS-... VMPA...-FB-EMG-...	■	–	4 (8)	The electronics module contains the serial communication system and facilitates: <ul style="list-style-type: none"> <li>• Transmission of switching information</li> <li>• Actuation of up to 8 solenoid coils</li> <li>• Position-based diagnosis</li> <li>• Separate voltage supply for valves</li> <li>• Transmission of status, parameter and diagnostic data</li> </ul> There are two variants: <ul style="list-style-type: none"> <li>• Not electrically isolated (VMPA...-FB-EMS-...)</li> <li>• Electrically isolated (VMPA...-FB-EMG-...)</li> </ul>
			–	■	2 (4)	

– - Note

- Multi-pin plug with modular linking
- Manifold sub-bases MPA1 and MPA2 can be combined as required
- Positive or negative switching actuation is possible (mixed operation is not permitted)
- Double solenoid valves cannot be mounted on single solenoid electronics modules
- Single solenoid valves can be mounted on double solenoid electronics modules

# Valve terminals type 32 MPA

Key features – Pneumatic components

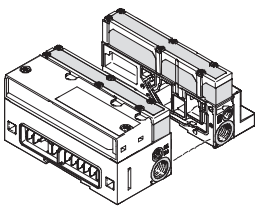
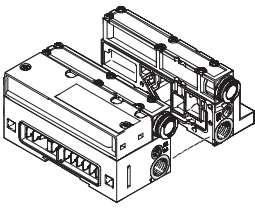
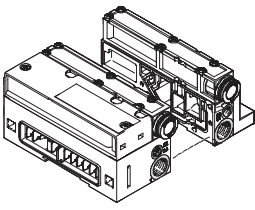
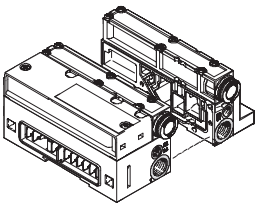

Ports for supply and venting							
Code		Port	Designation	Code L Push-in connector, large	Code K Push-in connector, small	Code D Thread for supply	
S		Internal pilot air, silencer					
		1	Compressed air/ vacuum supply	Push-in fitting	QS-G $\frac{1}{4}$ -10-l	QS-G $\frac{1}{4}$ -8-l	G $\frac{1}{4}$
		3/5	Exhaust air	Flat plate silencer	–	–	–
		12/14	Pilot air	–	–	–	–
		82/84	Pilot exhaust air	Flat plate silencer	–	–	–
			Pressure relieving port	Vents into the atmosphere via silencer			
T		External pilot air, silencer					
		1	Compressed air/ vacuum supply	Push-in fitting	QS-G $\frac{1}{4}$ -10-l	QS-G $\frac{1}{4}$ -8-l	G $\frac{1}{4}$
		3/5	Exhaust air	Flat plate silencer	–	–	–
		12/14	Pilot air	Push-in fitting	QSM-M7-6-l	QSM-M7-6-l	M7
		82/84	Pilot exhaust air	Flat plate silencer	–	–	–
			Pressure relieving port	Vents into the atmosphere via silencer			
V		Internal pilot air, ducted exhaust air					
		1	Compressed air/ vacuum supply	Push-in fitting	QS-G $\frac{1}{4}$ -10-l	QS-G $\frac{1}{4}$ -8-l	G $\frac{1}{4}$
		3/5	Exhaust air	Push-in fitting	QS-10	QS-10	QS-10
		12/14	Pilot air	–	–	–	–
		82/84	Pilot exhaust air	Push-in fitting	QSM-M7-6-l	QSM-M7-6-l	M7
			Pressure relieving port	Vents into duct 82/84			
X		External pilot air, ducted exhaust air					
		1	Compressed air/ vacuum supply	Push-in fitting	QS-G $\frac{1}{4}$ -10-l	QS-G $\frac{1}{4}$ -8-l	G $\frac{1}{4}$
		3/5	Exhaust air	Push-in fitting	QS-10	QS-10	QS-10
		12/14	Pilot air	Push-in fitting	QSM-M7-6-l	QSM-M7-6-l	M7
		82/84	Pilot exhaust air	Push-in fitting	QSM-M7-6-l	QSM-M7-6-l	M7
			Pressure relieving port	Vents into duct 82/84			

Valve terminals for standard applications  
Heavy-duty modular

2.2

# Valve terminals type 32 MPA

Key features – Assembly

## Valve terminal assembly

Sturdy terminal assembly thanks to:

- Four through-holes for wall mounting
- Additional mounting bracket
- H-rail mounting

### Wall mounting

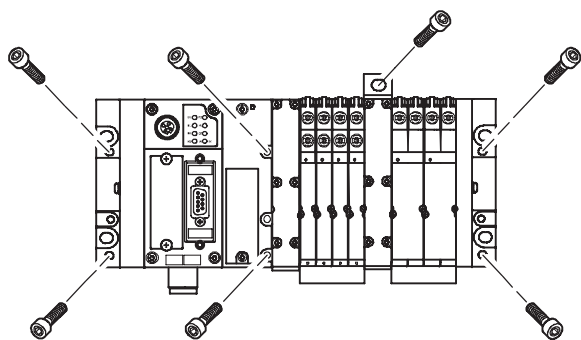
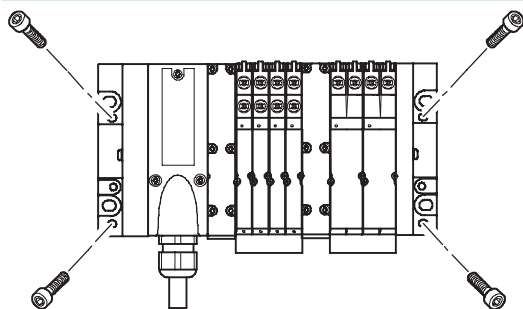

The MPA valve terminal is screwed onto the mounting surface using four M4 or M6 screws. The mounting holes are located at the following points:

- Multi-pin plug (4 pieces): at the pneumatic interface and the right-hand end plate
- Fieldbus (6 pieces): at the left-hand end plate (CPX) and right-hand end plate MPA. The pneumatic interface additionally provides further mounting holes as well as optional mounting brackets.

The fieldbus version additionally provides a bracket for wall mounting (type MPA, Part No. 665 983). The mounting brackets can be used with very long valve terminals (6 manifold blocks or more) to improve load capacity during vibrations or shocks.

### H-rail mounting

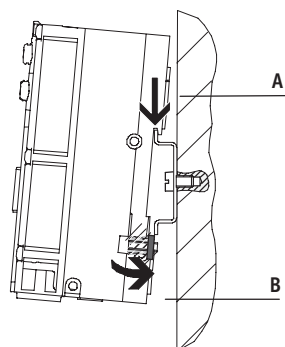

The MPA valve terminal is attached to the H-rail (see arrow A). The terminal is then swivelled about the H-rail and secured in place with the clamping component (see arrow B).

For H-rail mounting of the valve terminal you will need the following MPA mounting kit:

- With multi-pin plug: CPA-BG-NRH
- With fieldbus: CPX-CPA-BG-NRH

This permits mounting of the valve terminal on a H-rail to EN 60715.

### Individual valve assembly

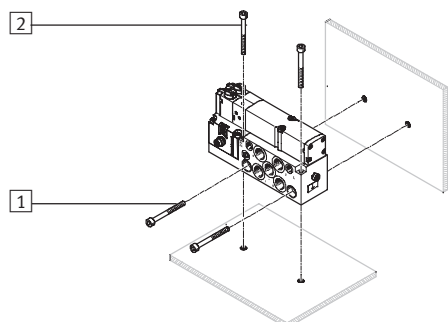

- 1 Horizontal mounting holes
- 2 Vertical mounting holes

The individual sub-base is designed for wall mounting for integration into a system or machine. It can be mounted horizontally or vertically.

# Valve terminals type 32 MPA

Key features – Display and operation



## Display and operation

Each valve solenoid coil is allocated an LED which indicates its signal status.

- Indicator 12 shows the switching status of the coil for output 2
- Indicator 14 shows the switching status of the coil for output 4

### Manual override

The manual override (MO) allows the valve to be actuated when not electrically activated or energised. The valve is activated by pushing the manual override. The set switching status can also be locked by rotating

the manual override (code R or as accessory).

Alternatives:

- A cover (code N or as accessory) can be fitted to prevent the manual override from being locked. The

valve can then only be actuated by pressing it.

- A cover (code V) can be fitted over the manual override to prevent it from being actuated accidentally.

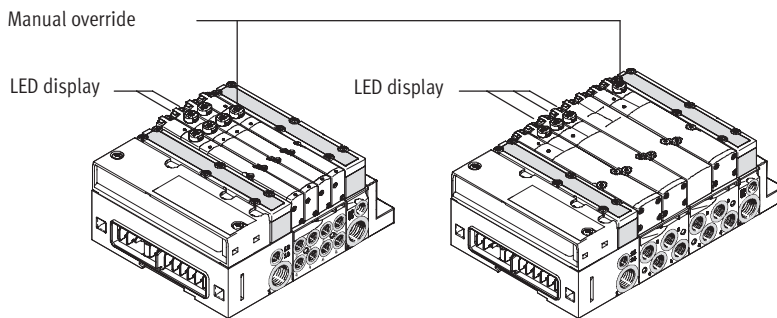

**Note**  
A manually actuated valve (manual override) cannot be reset electrically. Conversely, an electrically actuated valve cannot be reset using the manual override facility.

## Manual override (MO)

### Manual override with automatic return (non-detenting)

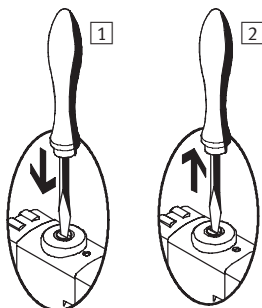

- 1 Press in the stem of the MO with a screwdriver. Pilot valve switches and actuates the main valve.
- 2 Remove the screwdriver. Spring force pushes the stem of the MO back. Pilot valve returns to initial position and so too the single solenoid main valve (not with double solenoid valve code J).

### Manual override with detent (detenting)

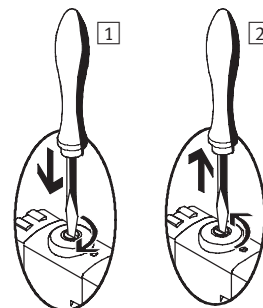

- 1 Press in the stem of the MO with a screwdriver until the valve switches and then turn the stem clockwise by 90° until the stop is reached. Valve remains in switching position
- 2 Turn the stem anti-clockwise by 90° until the stop is reached and then remove the screwdriver. Spring force pushes the stem of the MO back. Valve returns to initial position (not with double solenoid valve code J).

## Inscription system

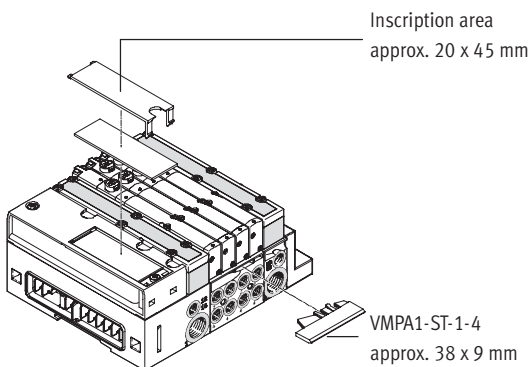

An inscription label holder VMPA1-ST-1-4 (Part No. 533 362, code T in the order code) or VMPA1-ST-2-4 (Part No. 544 384, for equipping with IBS-6x10 inscription labels) can be mounted on each manifold sub-base with a width of 42 mm for labelling the valves.

Large inscription labels can be applied to the pneumatic interface as an alternative or to complement the smaller labels. The following inscription labels can be used as spares:

- Inscription label MPA (20 x 45 mm): Part No. 663 010

# Valve terminals type 32 MPA

Key features – Electrical components

## Electrical power as a result of current reduction

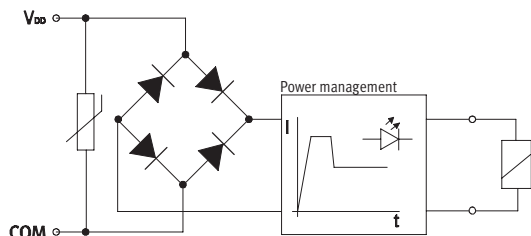

Each MPA solenoid coil is protected with a spark arresting protective circuit as well as against polarity reversal.

All valve types are additionally equipped with integrated current reduction, e.g. for fieldbus:

- Pull current: 60 mA
- Holding current is reduced to 25 mA after 20 ms

MPA valves are supplied with operating voltage in the range 18 ... 30 V (24 V +/-25%). This high tolerance is made possible through integrated control electronics and offers additional security, e.g. if the operating voltage drops.

## Individual valve

Valves can also be used on individual sub-bases for actuators remote from the valve terminal.

- Electrical M8 connection, 4-pin with screw connection
- Detachable electronics module with integrated holding current reduction

## Electrical multi-pin plug connection

The following multi-pin plug connection is offered for the valve terminal MPA:

- Sub-D multi-pin plug connection (25-pin)

Pins 1 ... 24 are used for addresses 1 ... 24 in order.

If fewer than 24 addresses are used for the valve terminal, the remaining

pins up to 24 are left free. Pin 25 is reserved for the neutral conductor.

The valves are switched by means of positive or negative logic (PNP or NPN). Mixed operation is not permitted.

Each pin on the multi-pin plug can activate only one valve solenoid coil. If the maximum configurable number

of valve positions is 24, this means that 24 valves can be addressed with one valve solenoid coil.

With 12 or less valve positions, 2 valve solenoid coils per valve can be addressed. With 12 or more valve positions, the number of available valve positions for valves with two solenoid coils decreases.



Note

If a single solenoid valve is assembled on a double solenoid valve position, the second address is also occupied and cannot be used.

## Guidelines on addressing for valves/valve solenoids

- The maximum possible number of addresses with a multi-pin plug connection is 24
- Each manifold sub-base/electronics module occupies a defined number of addresses/pins:
  - Manifold sub-base MPA1 for 4 single solenoid valves: 4
  - Manifold sub-base MPA1 for 4 double solenoid valves: 8
  - Manifold sub-base MPA2 for 2 single solenoid valves: 2
  - Manifold sub-base MPA2 for 2 double solenoid valves: 4
- The numbering of the addresses goes from left to right in ascending consecutive order. The following holds true at the individual valve positions: Address x for coil 14 and address x+1 for coil 12.
- If single solenoid valves are mounted on manifold sub-bases for double solenoid valves, the address of coil 12 and the assigned pin will remain unused.

## Fieldbus connection

All functions and features of the electrical peripherals CPX are permitted in connection with the CPX interface. This means:

- The valves and electrical outputs are supplied via the operating voltage connection of the CPX
- The valves are supplied and disconnected separately via a separate port on the CPX (code V)



Note

Further information can be found in → 4 / 4.8-2

# Valve terminals type 32 MPA

Key features – Electrical components



Pin allocation – Sub-D socket, cable								
	Pin	Address/coil	Core colour <sup>2)</sup>		Pin	Address/coil	Core colour <sup>2)</sup>	
	1	0	WH		17	16	WH PK	
	2	1	GN		18	17	PK BN	
	3	2	YE		19	18	WH BU	
	4	3	GY		20	19	BN BU	
	5	4	PK		21	20	WH RD	
	6	5	BU		22	21	BN RD	
	7	6	RD		23	22	WH BK	
	8	7	VT		24	23	BN	
	9	8	GY PK		25	0 V <sup>1)</sup>	BK	
	10	9	RD BU		Note The drawing shows a plan view of the Sub-D socket on the multi-pin cable VMPA-KMS1-....			
	11	10	WH GN					
	12	11	BN GN					
	13	12	WH YE					
	14	13	YE BN					
	15	14	WH GY					
	16	15	GY BN					

- 1) 0 V for positive switching control signals; connect 24 V for negative switching control signals; mixed operation is not permitted.  
 2) To IEC 757

## Dimensions Download CAD data → [www.festo.com/en/engineering](http://www.festo.com/en/engineering)

Connecting cables

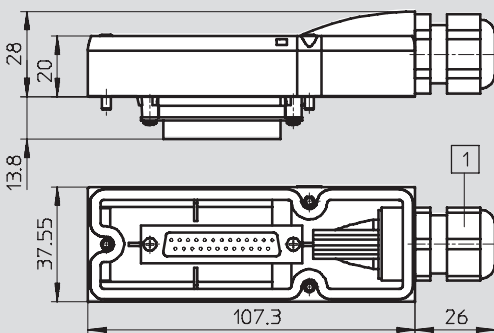

- 1 Cable conduit fitting with clamping range 6 ... 12 mm

The core colours refer to the following pre-assembled multi-pin cables from Festo:

- VMPA-KMS1-8-... valve terminal for up to 4 valve positions (8 coils)
- VMPA-KMS1-24-... valve terminal with 8 ... 24 valve positions

Type	Sheath	Length [m]	Core x mm <sup>2</sup>	D [mm]	Part No.
VMPA-KMS1-8-2.5	PVC	2.5	10 x 0.34	6.9	533 195
VMPA-KMS2-8-2.5-PUR	PUR	2.5	10 x 0.25	8.3	533 504
VMPA-KMS1-8-5	PVC	5	10 x 0.34	6.9	533 196
VMPA-KMS2-8-5-PUR	PUR	5	10 x 0.25	8.3	533 505
VMPA-KMS1-8-10	PVC	10	10 x 0.34	6.9	533 197
VMPA-KMS2-8-10-PUR	PUR	10	10 x 0.25	8.3	533 506
VMPA-KMS1-24-2.5	PVC	2.5	25 x 0.34	11.4	533 192
VMPA-KMS2-24-2.5-PUR	PUR	2.5	25 x 0.25	11.2	533 501
VMPA-KMS1-24-5	PVC	5	25 x 0.34	11.4	533 193
VMPA-KMS2-24-5-PUR	PUR	5	25 x 0.25	11.2	533 502
VMPA-KMS1-24-10	PVC	10	25 x 0.34	11.4	533 194
VMPA-KMS2-24-10-PUR	PUR	10	25 x 0.25	11.2	533 503
VMPA-KMS-H	Cover for self-assembly				533 198

# Valve terminals type 32 MPA

Key features – Electrical components



## Electrical connection – Individual valve interface

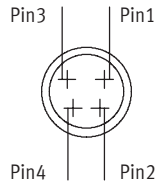
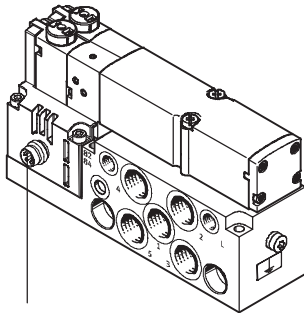

### Pin allocation on individual valve to VDMA 24571

With positive logic:

- Pin1 – Not allocated
- Pin2 –  $U_B$  for coil 12
- Pin3 – 0 V for coils 12 and 14
- Pin4 –  $U_B$  for coil 14

With negative logic:

- Pin1 – Not allocated
- Pin2 – 0 V for coil 12
- Pin3 –  $U_B$  for coils 12 and 14
- Pin4 – 0 V for coil 14

### Tightening torque for M8 plug

0.25 ... 0.5 Nm (manual torque)

Connector plug M8 x 1, 4-pin to EN 60 947-5-2

## Connecting cables

Type	Designation	Version	Cable length [m]	Part No.
SIM-M8-4GD-2,5-PU	Plug socket with cable	Straight socket	2.5	<b>158 960</b>
SIM-M8-4GD-5-PU	Plug socket with cable	Straight socket	5	<b>158 961</b>
SIM-M8-4WD-2,5-PU	Plug socket with cable	Angled socket	2.5	<b>158 962</b>
SIM-M8-4WD-5-PU	Plug socket with cable	Angled socket	5	<b>158 963</b>

## Instructions for use

### Equipment

Operate your equipment with unlubricated compressed air if possible. Festo valves and cylinders have been designed so that, if used as intended, they will not require additional lubrication and will still achieve a long service life. The quality of compressed air downstream from the compressor must correspond to that of unlubricated compressed air. If possible, do not operate all of your equipment with lubricated compressed air. The lubricators should, where possible, always be installed directly upstream of the actuator used.

Incorrect additional oil and too high an oil content in the compressed air reduce the service life of the valve terminal. Use Festo special oil OFSW-32 or the alternatives listed in the Festo catalogue (as specified in DIN 51524 HLP32; basic oil viscosity 32 CST at 40 °C).

### Bio-oils

When using bio-oils (oils which are based upon synthetic or native ester, e.g. rapeseed oil methyl ester), the maximum residual oil content of 0.1 mg/m<sup>3</sup> must not be exceeded (see ISO 8573-1 Class 2).



### Mineral oils

When using mineral oils (e.g. HLP oils to DIN 51524, parts 1 through 3) or similar oils based on poly-alpha-olefins (PAO), the maximum residual oil content of 5 mg/m<sup>3</sup> must not be exceeded (see ISO 8573-1 Class 4). A higher residual oil content irrespective of the compressor oil cannot be permitted, as the basic lubricant would be flushed out over time.



# Valve terminals type 32 MPA

Technical data

-  - Flow rate  
MPA1: Up to 360 l/min  
MPA2: Up to 700 l/min
-  - Valve width  
MPA1: 10 mm  
MPA2: 21 mm
-  - Voltage  
24 V DC

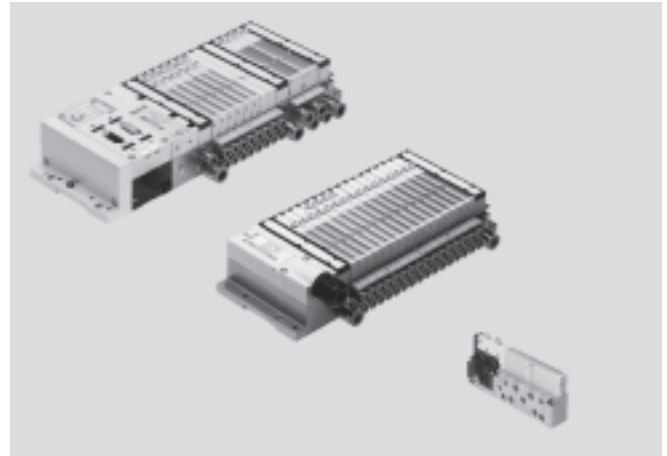

General technical data		MPA1	MPA2
Constructional design		Electromagnetically actuated piston spool valve	
Lubrication		Lubrication for life, PWIS-free (free of paint-wetting impairment substances)	
Type of mounting		Wall mounting	
		On H-rail to EN 60715	
Mounting position		Any	
Manual override		Pushing/turning with detent/covered	
Width	[mm]	10.5	21
Nominal diameter	[mm]	2.5	
<b>Pneumatic connections</b>			
Pneumatic connection		Via manifold sub-base or individual connection	
Supply port	1	G $\frac{1}{4}$ (M7 with individual sub-base)	
Exhaust port	3/5	QS-10 (M7 with individual sub-base)	
Working ports	2/4	Depending on the connection type selected	
		<ul style="list-style-type: none"> <li>• M7</li> <li>• QS4</li> <li>• QS6</li> </ul>	<ul style="list-style-type: none"> <li>• G<math>\frac{1}{8}</math></li> <li>• QS6</li> <li>• QS8</li> </ul>
Pilot air port	12/14	M7 (M5 with individual sub-base)	
Pilot exhaust air port	82/84	M7 (M5 with individual sub-base)	
Pressure relieving port		With ducted exhaust air: via port 82/84 (M5 with individual sub-base)	
		With flat plate silencer: venting to atmosphere	

# Valve terminals type 32 MPA

Technical data



Valve terminals for standard applications  
Heavy-duty modular

Operating and environmental conditions		M	J	N	K	H	B	G	E	X	W	D	I				
Valve function order code																	
Operating medium		Filtered compressed air, lubricated or unlubricated, inert gases → 4 / 2.2-32															
Grade of filtration		[µm] 40															
Operating pressure	With internal pilot air	[bar] 3 ... 8															
	With external pilot air	[bar] -0.9 ... +10				3 ... 10				-0.9 ... +10				3 ... 10			
	Pilot air	[bar] 3 ... 8															
Ambient temperature		[°C] -5 ... +50															
Temperature of medium		[°C] -5 ... +50															
Storage temperature <sup>1)</sup>		[°C] -20 ... +40															
Relative air humidity at 40 °C		[%] 90															
Certification		c UL us - Recognised (OL)															
Corrosion resistance class CRC <sup>2)</sup>		1															

- 1) Long-term storage
- 2) Corrosion resistance class 1 to Festo standard 940 070  
Components requiring low corrosion resistance. Transport and storage protection. Parts that do not have primarily decorative surface requirements, e.g. in internal areas that are not visible or behind covers.

## Pilot pressure p2 as a function of working pressure p1 with external pilot air

for valves with code M, J, B, G, E, X

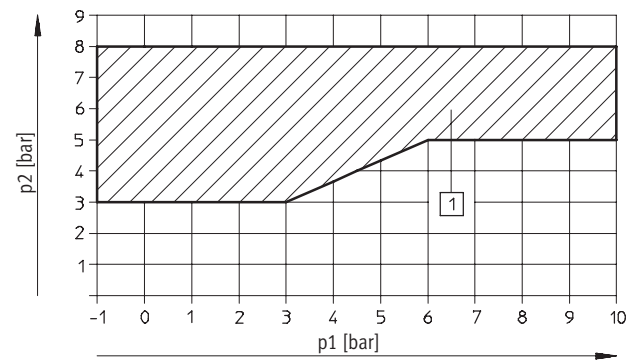

1 Operating range for valves with external pilot air

for valves with code N, K, H, D, I

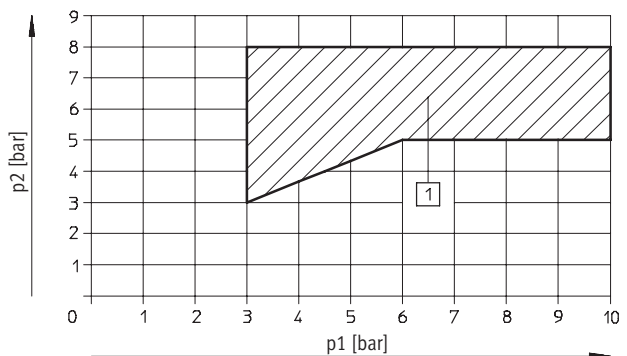

1 Operating range for valves with external pilot air

# Valve terminals type 32 MPA

Technical data

FESTO

Nominal flow rate [l/min] <sup>1)</sup>					
Code	Valve function	Without fitting		With fitting <sup>2)</sup>	
		From port 1 to 2, or 1 to 4	From port 2 to 3/5, or 4 to 3/5	From port 1 to 2, or 1 to 4	From port 2 to 3/5, or 4 to 3/5
<b>MPA1</b>					
M	5/2-way valve, single solenoid	360	360	360	360
J	5/2-way valve, double solenoid	360	360	360	360
N	2x 3/2-way valve, normally open	300	300	300	300
K	2x 3/2-way valve, normally closed	230	310	230	310
H	2x 3/2-way valve, 1x normally open, 1x normally closed	280	305	280	305
B	5/3-way valve, mid-position pressurised	300 (195) <sup>3)</sup>	270	300 (195) <sup>3)</sup>	270
G	5/3-way valve, mid-position closed	320	320	320	320
E	5/3-way valve, mid-position exhausted	240	240 (180) <sup>3)</sup>	240	240 (180) <sup>3)</sup>
X	1x 3/2-way valve	255	295	255	295
W	1x 3/2-way valve	255	295	255	295
D	2x 2/2-way valve	230	230	230	230
I	2x 2/2-way valve	260	260	230	260
<b>MPA2</b>					
M	5/2-way valve, single solenoid	700	700	660	670
J	5/2-way valve, double solenoid	700	700	660	670
N	2x 3/2-way valve, normally open	560	490	550	480
K	2x 3/2-way valve, normally closed	500	560	500	540
H	2x 3/2-way valve, 1x normally open, 1x normally closed	500	490	500	480
B	5/3-way valve, mid-position pressurised	520	650 (350) <sup>3)</sup>	510	600 (350) <sup>3)</sup>
G	5/3-way valve, mid-position closed	630	630	600	610
E	5/3-way valve, mid-position exhausted	610	440 (350) <sup>3)</sup>	590	420 (350) <sup>3)</sup>
X	1x 3/2-way valve	500	590	470	560
W	1x 3/2-way valve	500	590	470	560
D	2x 2/2-way valve	680	–	650	–
I	2x 2/2-way valve	680	500	650	500

- 1) Values also apply to individual sub-bases
- 2) Flows measured on manifold sub-base with fitting QS-M7-6-I for MPA1 and QS-G1/8-8-I for MPA2
- 3) Value for mid-position

Valve response times [ms]													
Valve function order code		M	J	N	K	H	B	G	E	X	W	D	I
<b>MPA1</b>													
Response times	On	10	10	10	10	10	10	10	10	10	10	10	10
	Off	20	–	20	20	20	35	35	35	20	20	20	20
	Change-over	–	15	–	–	–	–	–	–	–	–	–	–
<b>MPA2</b>													
Response times	On	15	9	8	8	8	11	10	11	13	13	7	7
	Off	28	–	28	28	28	46	40	47	22	22	25	25
	Change-over	–	22	–	–	–	23	21	23	–	–	–	–

# Valve terminals type 32 MPA

Technical data



Valve terminals for standard applications  
Heavy-duty modular

2.2

Electrical data		
MPA with CPX terminal		
Voltage supply for electronics ( $U_{EL/SEN}$ )		
Nominal voltage	[V]	24 DC
Operating voltage range	[V]	18 ... 30 DC
Max. intrinsic current consumption per electronics module at 24 V (regardless of the switching status of the valves)	[mA]	20
Load voltage supply for valves ( $U_{VAL}$ )		
Nominal voltage	[V]	24 DC
Operating voltage range	[V]	18 ... 30 DC
Max. intrinsic current consumption at 24 V (regardless of the switching status of the valves) per electronics module		
VMPA1-FB-EMS-8 or VMPA2-FB-EMS-4	[mA]	8 not electrically isolated (max. signal line length 10 m)
VMPA1-FB-EMG-8 or VMPA2-FB-EMG-4	[mA]	25 electrically isolated
Diagnostic message on undervoltage $U_{OFF}$ , load voltage outside function range	[V]	17.5 ... 16
Protection class to EN 60529		IP65 (for all types of signal transmission in assembled state)
Max. current consumption per solenoid coil at nominal voltage		MPA1
Nominal pull current	[mA]	45
Nominal current with current reduction	[mA]	8
Time until current reduction	[ms]	20
		MPA2
		90
		18
		20
Calculation example		
Current consumption with two solenoid coils MPA2 switched in parallel and one electronics module without electrical isolation	[mA]	$I_{EL/SEN} = 20$
Nominal pull current	[mA]	$I_{VAL} = 8 + 2 \times 90 = 188$
Nominal current with current reduction	[mA]	$I_{VAL} = 8 + 2 \times 18 = 44$

MPA with multi-pin plug connection		
Power supply		
Nominal voltage	[V]	24 DC
Operating voltage range	[V]	18 ... 30 DC
Residual ripple	[Vss]	4
Current consumption at Sub-D multi-pin plug connection per solenoid coil at nominal voltage		MPA1
Nominal pull current	[mA]	80
Nominal current with current reduction	[mA]	25
Time until current reduction	[ms]	25
		MPA2
		100
		20
		50

# Valve terminals type 32 MPA

Technical data

FESTO

Data on vibration and shock in accordance with DIN/IEC68	
	MPA1
Vibration <sup>1)</sup>	Tested to DIN/IEC68 / EN 60068 Parts 2 ... 6 With horizontal H-rail mounting: Severity level 1 With wall mounting: <sup>2)</sup>
Shock <sup>1)</sup>	Tested to DIN/IEC68 / EN 60068 Parts 2 ... 27 With horizontal H-rail mounting: Severity level 1 With wall mounting: Severity level 1 ... <sup>2)</sup>
Continuous shock	Tested to DIN/IEC68 / EN 60068 Parts 2 ... 29 With wall and H-rail mounting: Severity level 1

- 1) See the CPX System Description for information on vibration and shock for the CPX terminal.  
 2) MPA valve terminal with MPM connection and more than 5 sub-bases: Severity level 1  
 Valve terminal MPA with CPX terminal or MPM connection and  
 up to 5 sub-bases without additional attachments: Severity level 2  
 6 or more manifold blocks without additional mounting (wall bracket) after 2 to max. 4 manifold blocks: Severity level 2

Test conditions			
Severity level	Vibration	Shock	Continuous shock
1	0.15 mm travel at 10 ... 58 Hz, 2 g acceleration at 58 - 150 Hz	±15 g at 11 ms duration, 5 shocks per direction	±15 g at 6 ms duration, 1000 shocks per direction
2	0.35 mm travel at 10 - 60 Hz, 5 g acceleration at 60 - 150 Hz	±30 g at 11 ms duration, 5 shocks per direction	–
Continuous shock resistance	To DIN/IEC 68/EN 60068, Parts 2-29: +/-15 g at 6 ms, 1000 cycles		

Valve terminals for standard applications  
Heavy-duty modular

2.2

# Valve terminals type 32 MPA

Technical data

FESTO

Valve terminals for standard applications  
Heavy-duty modular

2.2

Materials		
	MPA1	MPA2
Manifold sub-base	Die-cast aluminium	
Valve	Die-cast aluminium	
Seals	NBR, elastomer	
Supply plate	Die-cast aluminium	
Right-hand end plate	Die-cast aluminium	
Left-hand pneumatic interface	Die-cast aluminium, polyamide	
Exhaust plate	Polyamide	
Flat plate silencer	Polyethylene	
Electrical supply plate	Housing: Die-cast aluminium Cover: Reinforced polyamide	
Electronics module	Polycarbonate	
Electrical interlinking module	Bronze/polybutylene terephthalate	

Product weight			
Approx. weights	[g]	MPA1	MPA2
Connection block - basic weight <sup>1)</sup>		400 (4 valve positions)	400 (2 valve positions)
Manifold sub-base <sup>1)</sup>		185	
Individual sub-base		45	
per valve M, X, W		49	100
per valve J, N, K, H, B, G, E, D		56	100
per vacant position L		24	44
Right-hand end plate		55	
Left-hand pneumatic interface <sup>1)</sup>			
• with flat plate silencer		315	
• with ducted exhaust air		324	
Supply plate <sup>1)</sup>			
• with flat plate silencer		111	
• with ducted exhaust air		120	
Electrical supply plate		200	
QSM-M5-3-I		3	
QSM-M5-4-I		4	
QSM-M5-6-I		5	
QSM-M7-4-I		6	
QSM-M7-6-I		5	
QS-G $\frac{1}{8}$ -6-I		22	
QS-G $\frac{1}{8}$ -8-I		13	
QS-G $\frac{1}{4}$ -8-I		22	
QS-G $\frac{1}{4}$ -10-I		23	

1) With thin metal seal, inscription label holder, screws

# Valve terminals type 32 MPA

Technical data



## Dimensions

Download CAD data → [www.festo.com/en/engineering](http://www.festo.com/en/engineering)

Valve terminal with multi-pin plug connection

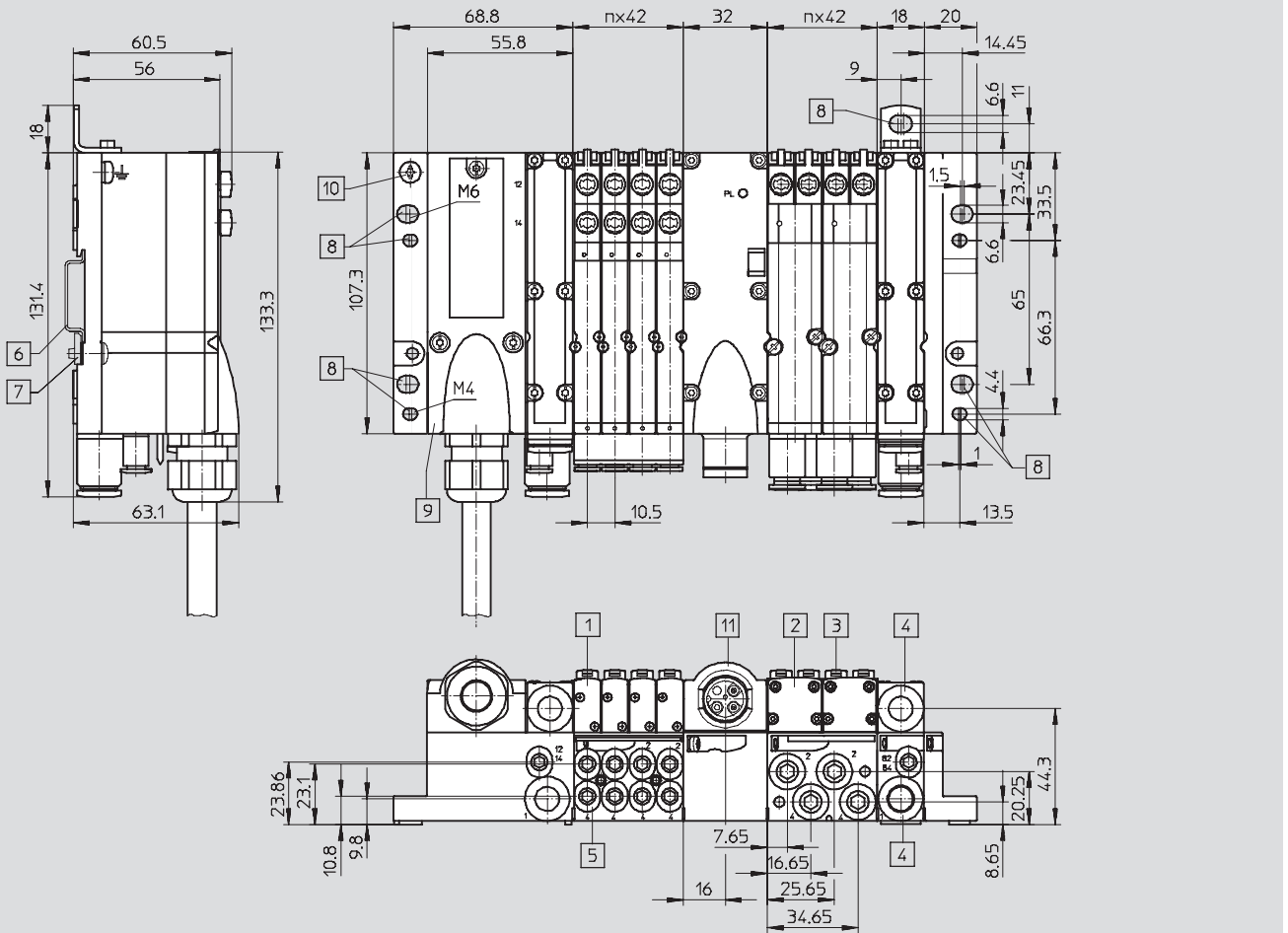

- |                        |                   |                             |  |
|------------------------|-------------------|-----------------------------|--|
| 1 Solenoid valve MPA1  | 5 Working ports   | 9 Multi-pin plug connection | n Number of sub-bases in a grid of 4 MPA1 or 2 MPA2 valves |
| 2 Solenoid valve MPA2  | 6 H-rail          | 10 Earthing screw           |  |
| 3 Manual override      | 7 H-rail mounting | 11 Electrical supply plate  |  |
| 4 Supply/exhaust ports | 8 Mounting holes  |                             |  |

Valve terminals for standard applications  
Heavy-duty modular

## 2.2

# Valve terminals type 32 MPA

Technical data



## Dimensions

Download CAD data → [www.festo.com/en/engineering](http://www.festo.com/en/engineering)

Valve terminal with fieldbus connection

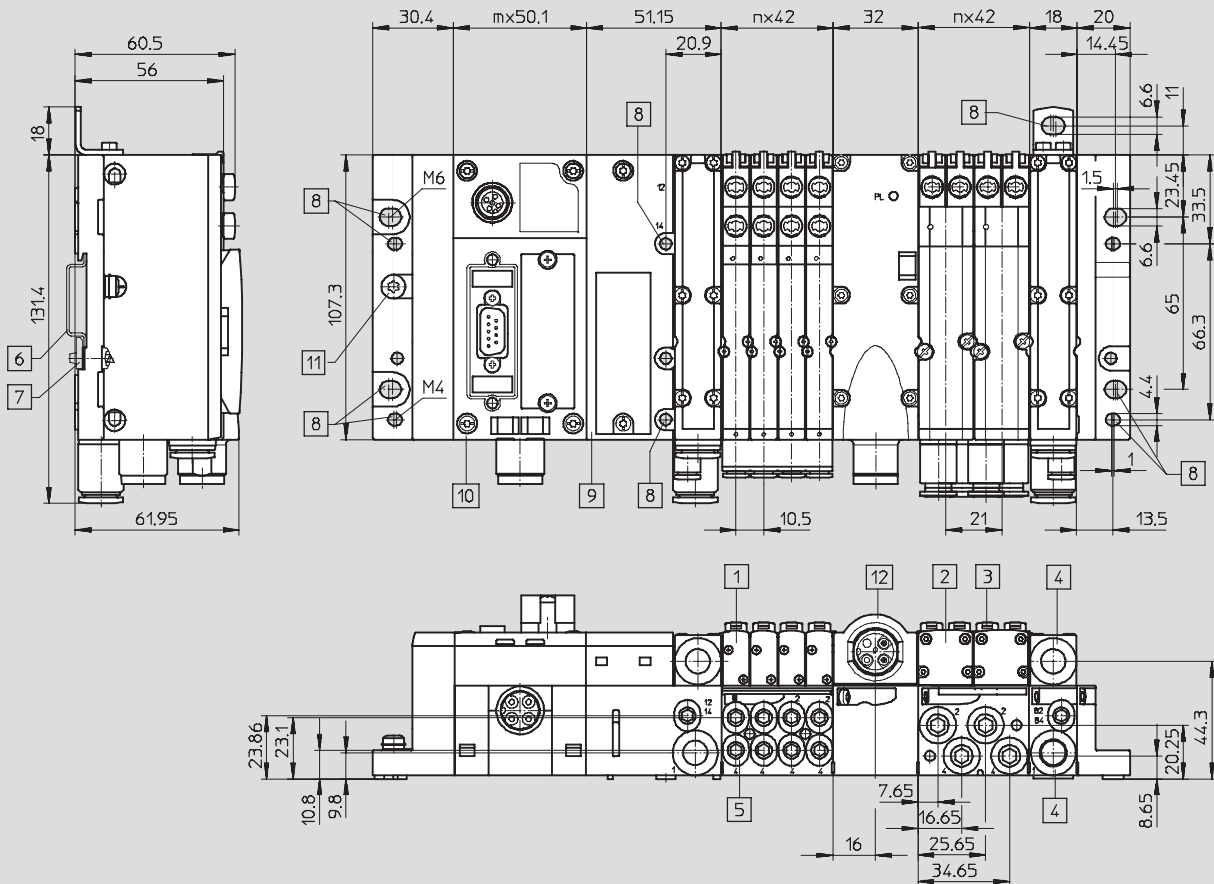

- |                        |                       |                            |  |
|------------------------|-----------------------|----------------------------|--|
| 1 Solenoid valve MPA1  | 5 Working ports       | 9 Left-hand end plate      | n Number of sub-bases in a grid of 4 MPA1 or 2 MPA2 valves |
| 2 Solenoid valve MPA2  | 6 H-rail              | 10 CPX module              | m Number of CPX modules                                    |
| 3 Manual override      | 7 H-rail mounting kit | 11 Earthing screw          |  |
| 4 Supply/exhaust ports | 8 Mounting holes      | 12 Electrical supply plate |  |

Valve terminals for standard applications  
Heavy-duty modular

2.2



# Valve terminals type 32 MPA

Technical data



Dimensions Download CAD data → [www.festo.com/en/engineering](http://www.festo.com/en/engineering)

MPA1 valve on individual sub-base

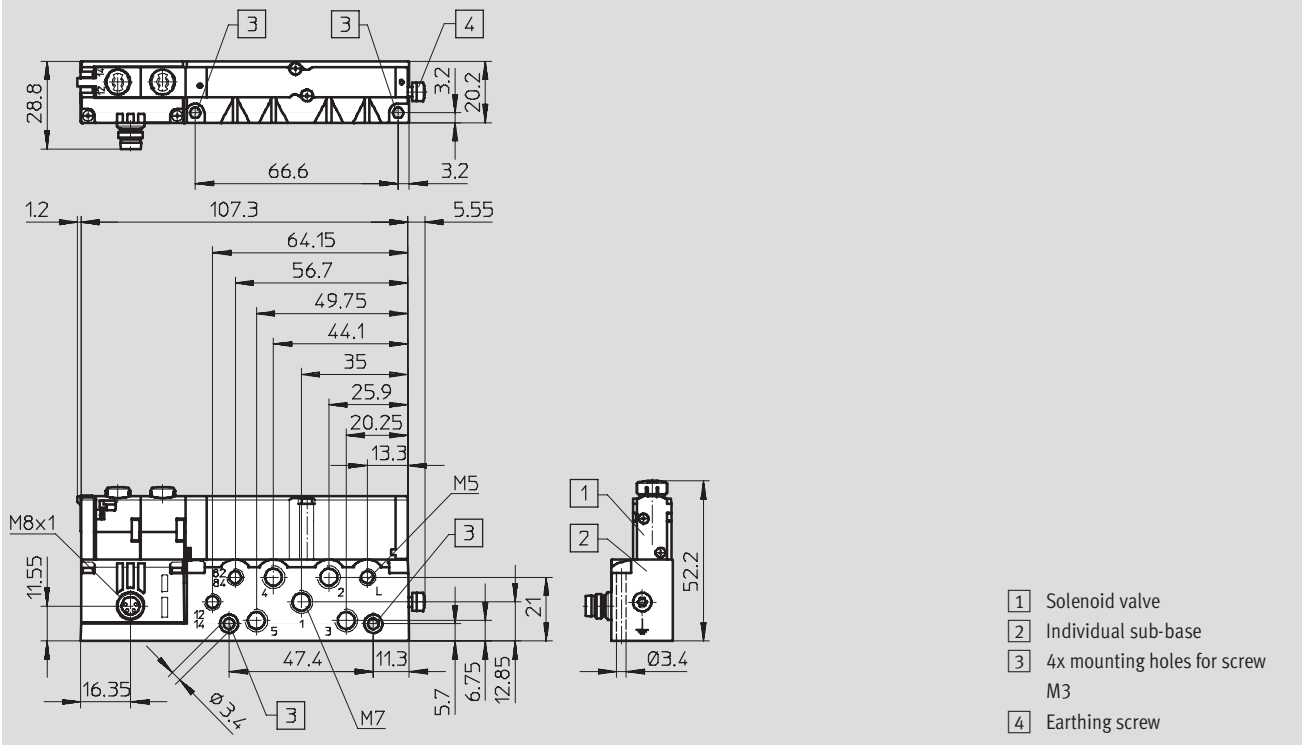

MPA2 valve on individual sub-base

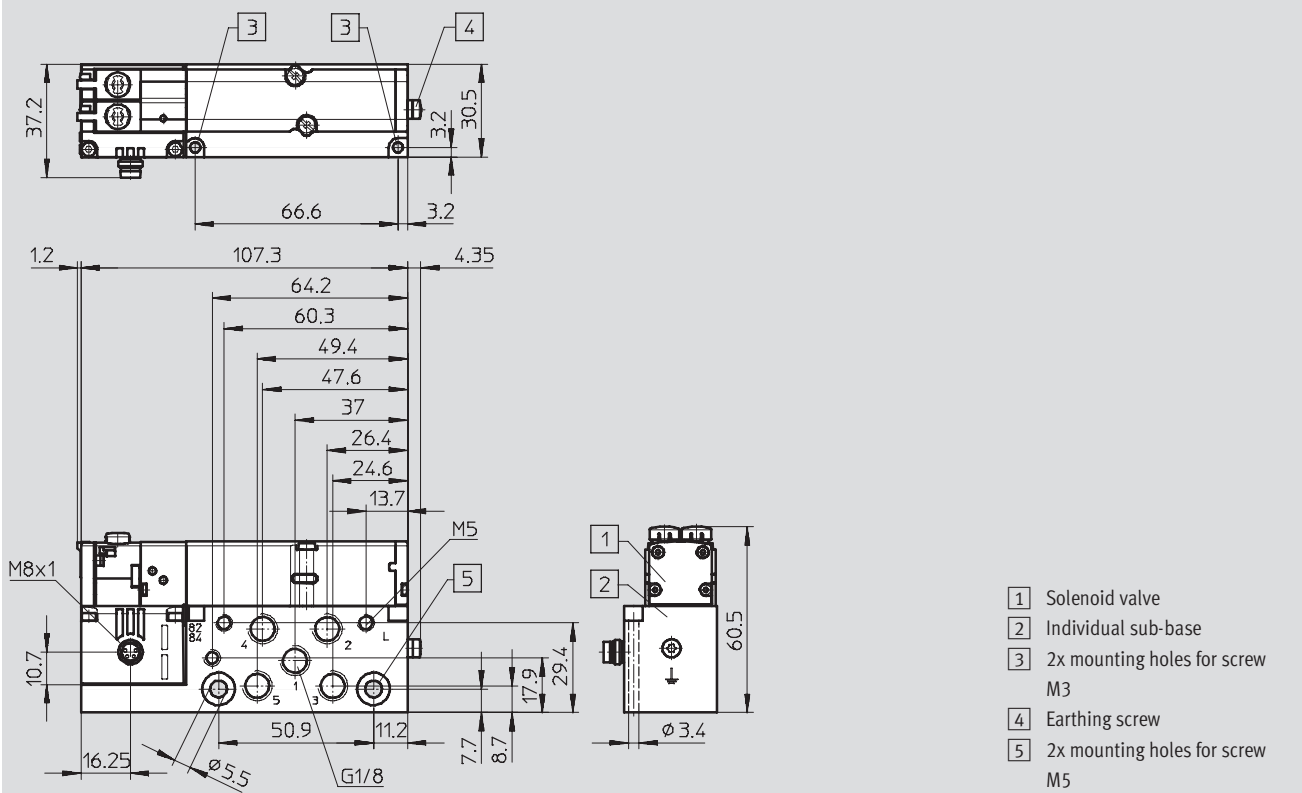

Valve terminals for standard applications  
Heavy-duty modular  
**2.2**

# Valve terminals type 32 MPA – Electrical part MPM



Ordering data – Modular products

Valve terminals for standard applications  
Heavy-duty modular

2.2

M Mandatory data			O Options	
Module No.	Valve terminal, electrical part	Electrical actuation	User documentation	Electrical accessories
539 105	32E	MPM	D, E, F, I, S, V	H A, B, C D, E, F GA, GB, GC GD, GE, GF
<b>Order example</b>				
539 105	32E	- MPM	- D	+ D
1	2	3	4	5

Ordering table			Condi- tions	Code	Enter code				
M	1	Module No.	539 105						
	2	Valve terminal, electrical part	Valve terminal type 32, MPA, with multi-pin plug connection	32E	32E				
	3	Electrical actuation	Multi-pin plug connection, modular	-MPM	-MPM				
O	4	User documentation	German	-D					
			English	-E					
			French	-F					
			Italian	-I					
			Spanish	-S					
			Swedish	-V					
	5	Electrical accessories		+	+				
		H-rail mounting	1	H					
		Multi-pin cable	Polyvinyl chloride						
						Pre-assembled multi-pin cable for max. 8 addresses, 2.5 m, Sub-D	1	A	
						Pre-assembled multi-pin cable for max. 8 addresses, 5 m, Sub-D	1	B	
						Pre-assembled multi-pin cable for max. 8 addresses, 10 m, Sub-D	1	C	
						Pre-assembled multi-pin cable for max. 24 addresses, 2.5 m, Sub-D		D	
						Pre-assembled multi-pin cable for max. 24 addresses, 5 m, Sub-D		E	
			Polyurethane						
							Pre-assembled multi-pin cable for max. 8 addresses, 2.5 m, Sub-D	1	GA
							Pre-assembled multi-pin cable for max. 8 addresses, 5 m, Sub-D	1	GB
							Pre-assembled multi-pin cable for max. 8 addresses, 10 m, Sub-D	1	GC
							Pre-assembled multi-pin cable for max. 24 addresses, 2.5 m, Sub-D		GD
							Pre-assembled multi-pin cable for max. 24 addresses, 5 m, Sub-D		GE
		Pre-assembled multi-pin cable for max. 24 addresses, 10 m, Sub-D		GF					

1 A, B, C, GA, GB, GC

Note the maximum permissible number of addresses for the module blocks!

Transfer order code

539 105	32E	-	MPM	-		+	
1	2		3		4		5

# Valve terminals type 32 MPA – Pneumatic part MPM



Ordering data – Modular products

**M** Mandatory data →

Module No.	Valve terminal, pneumatic part	Pneumatic supply	Pneumatic working port	Pneumatic supply connection	Manual override
539 105	32P	S, T, V, X	G, F, C	L, K, D	N, R, V
<b>Order example</b>					
539 105	32P	- V	C	D	- R
1	2	3	4	5	6

**Ordering table**

Size	1	2	Condi- tions	Code	Enter code	
<b>M</b> 1	Module No.	539 105	539 105			
2	Valve terminal, pneumatic part	Valve terminal type 32, MPA, modular sub-base valves			32P	32P
3	Pneumatic supply to valve terminal	Internal pilot air supply, silencer		-S		
		External pilot air supply, silencer		-T		
		Internal pilot air supply, ducted exhaust air	1	-V		
		External pilot air supply, ducted exhaust air	1	-X		
4	Pneumatic working port	Large push-in connector in working port (6 mm)   (8 mm)		G		
		Small push-in connector in working port (4 mm)   (6 mm)		F		
		Thread in working port (M7)   (G1/8)		C		
5	Pneumatic supply connection	Push-in connector QS10 for supply		L		
		Push-in fitting QS8 for supply		K		
		Thread G3/4 for supply		D		
6	Manual override	Pushing		-N		
		Pushing/detenting		-R		
		Covered		-V		

1 V, X At least 1 pneumatic supply plate U, V or W must be selected (position freely selectable)

Transfer order code

539 105	32P	-				-	
1	2	3	4	5	6		

# Valve terminals type 32 MPA – Pneumatic part MPM



Ordering data – Modular products

Valve terminals for standard applications  
Heavy-duty modular

2.2

**Mandatory data**

Pneumatic module blocks 0 ... 12

7 Type of module block: M, A, B, C, D

**Options**

8 Duct separation: I

9 Duct separation: S, T, R

10 Supply plate: U, V, W

Module position

0	1	2	3	4	5	6	7	8	9	10	11	12
M	B	B	B	U	B	D						

7 + 8 + 9 + 10

**Ordering table**

Size	1	2	Condi- tions	Code	Enter code	
<b>M</b> 7	Pneumatic module blocks 0 ... 12			-	-	
	Type of module block for block 0 ... 12				Enter equip- ment selection for mod- ule posi- tions in order code	
	Connection block for size 1, 8 addresses	-	[2]	<b>M</b>		
	-	Connection block for size 2, 4 addresses	[3]	<b>A</b>		
	Connection block for size 1, 4 addresses (single)	-	[3]	<b>B</b>		
	-	Connection block for size 2, 2 addresses (single)	[3]	<b>C</b>		
			[3]	<b>D</b>		
[0] 8	Duct separation in sub-base 1 ... 12		Separation duct 1	[4]		<b>I</b>
9	Duct separation for block 0 ... 12		Separating seal for duct 1, 3, 5	[4]		<b>S</b>
			Separating seal for duct 1	[4]		<b>T</b>
			Separating seal for duct 3, 5	[4]		<b>R</b>
10	Pneumatic supply plate for block 1 ... 12		Supply plate	[5]	<b>U</b>	
			Supply plate with separating seal on left	[6]	<b>V</b>	
			Supply plate with separating seal on right	[6]	<b>W</b>	

[2] **M** Only on block 0

[3] **A, B, C, D**

Each module block must be fully equipped

[4] **I, S, T, R**

If a duct is separated, a pneumatic supply plate U, V or W must be selected to the right of it before the next duct separation of the same duct or before the right-hand end plate

[5] **U** Must be selected if no duct separation R, S or T was selected

[6] **V, W** Must be selected if duct separation R, S or T was selected

**Transfer order code**

Module position

0	1	2	3	4	5	6	7	8	9	10	11	12

7 + 8 + 9 + 10

# Valve terminals type 32 MPA – Pneumatic part MPM

Ordering data – Modular products



<b>→ M Mandatory data</b>	<b>0 Options</b>																																																
<p><b>Pneumatic valve positions 0 ... 23</b></p> <p>M, J, N, K, H, B, G, E, D, I, X, W, L</p> <p>Valve position</p> <table style="width: 100%; text-align: center;"> <tr> <td>0</td><td>1</td><td>2</td><td>3</td><td>4</td><td>5</td><td>6</td><td>7</td><td>8</td><td>9</td><td>10</td><td>11</td><td>12</td><td>13</td><td>14</td><td>15</td><td>16</td><td>17</td><td>18</td><td>19</td><td>20</td><td>21</td><td>22</td><td>23</td> </tr> <tr> <td>J</td><td>K</td><td>M</td><td>M</td><td>M</td><td>D</td><td>L</td><td>J</td><td>M</td><td>M</td><td></td><td></td><td></td><td></td><td></td><td></td><td></td><td></td><td></td><td></td><td></td><td></td><td></td><td></td> </tr> </table> <p style="text-align: left;">- <b>11</b></p>	0	1	2	3	4	5	6	7	8	9	10	11	12	13	14	15	16	17	18	19	20	21	22	23	J	K	M	M	M	D	L	J	M	M															<p><b>Pneumatic accessories</b></p> <p>...T, ...J</p> <p style="text-align: right;">+ <b>8T2J</b></p> <p style="text-align: right;"><b>12</b></p>
0	1	2	3	4	5	6	7	8	9	10	11	12	13	14	15	16	17	18	19	20	21	22	23																										
J	K	M	M	M	D	L	J	M	M																																								

Ordering table					
Size	1	2	Condi- tions	Code	Enter code
<b>M</b> <b>11</b>	Pneumatic valve positions 0 ... 23			-	-
	Valves	5/2-way valve, single solenoid		<b>M</b>	Enter equip- ment selection for valve positions in order code
		5/2-way valve, double solenoid	[7]	<b>J</b>	
		2x 3/2-way valve, normally open	[7]	<b>N</b>	
		2x 3/2-way valve, normally closed	[7]	<b>K</b>	
		2x 3/2-way valve, 1x normally open, 1x closed	[7]	<b>H</b>	
		5/3-way valve, mid-position pressurised	[7]	<b>B</b>	
		5/3-way valve, mid-position closed	[7]	<b>G</b>	
		5/3-way valve, mid-position exhausted	[7]	<b>E</b>	
		2x 2/2-way valve, normally closed	[7]	<b>D</b>	
		2x 2/2-way valve, 1x normally closed and 1x normally closed, reversible	[7]	<b>I</b>	
		3/2-way valve, normally closed, external supply air		<b>X</b>	
		3/2-way valve, normally open, external compressed air supply		<b>W</b>	
		Blanking plate		<b>L</b>	
Pneumatic accessories				<b>+</b>	
Inscription label per manifold sub-base		1 ... 99		...T	
Sensor bracket for additional wall mounting		1 ... 99		...J	

[7] **J, N, K, H, B, G, E, D, I**  
Cannot be selected on module block C or D

### Transfer order code

Valve position

0	1	2	3	4	5	6	7	8	9	10	11	12	13	14	15	16	17	18	19	20	21	22	23	
-																								
<b>11</b>																							+ <b>12</b>	

Valve terminals for standard applications  
Heavy-duty modular  
**2.2**

# Valve terminals type 32 MPA – Pneumatic part CPX



Ordering data – Modular products

Valve terminals for standard applications  
Heavy-duty modular

2.2

**M** Mandatory data →

Module No.	Valve terminal, pneumatic part	Pneumatic supply	Pneumatic working port	Pneumatic supply connection	Manual override
530 411	32P	S, T, V, X	G, F, C	L, K, D	N, R, V
<b>Order example</b>					
530 411	32P	- V	C	D	- R
1	2	3	4	5	6

**Ordering table**

Size	1	2	Condi- tions	Code	Enter code
<b>M</b> 1	Module No.	530 411	530 411		
2	Valve terminal, pneumatic part	Valve terminal type 32, MPA, modular sub-base valves		32P	32P
3	Pneumatic supply to valve terminal	Internal pilot air supply, silencer		-S	
		External pilot air supply, silencer		-T	
		Internal pilot air supply, ducted exhaust air		<sup>1</sup> -V	
		External pilot air supply, ducted exhaust air		<sup>1</sup> -X	
4	Pneumatic working port	Large push-in connector in working port (6 mm)   (8 mm)		G	
		Small push-in connector in working port (4 mm)   (6 mm)		F	
		Thread in working port (M7)   (G1/8)		C	
5	Pneumatic supply connection	Push-in fitting QS10 at supply port		L	
		Push-in fitting QS8 at supply port		K	
		Thread G1/4 for supply port		D	
6	Manual override	Pushing		-N	
		Pushing/detenting		-R	
		Covered		-V	

<sup>1</sup> **V, X** At least 1 pneumatic supply plate U, V or W must be selected (position freely selectable)

**Transfer order code**

530 411	32P	-	-	-	-
1	2	3	4	5	6

# Valve terminals type 32 MPA – Pneumatic part CPX

Ordering data – Modular products



**Mandatory data**

Pneumatic module blocks 0 ... 16

7 Type of interlinking block: M, A, B

**Options**

8 Electrical module: H

9 Duct separation in interlinking block: I

10 Duct separation: S, T, R

11 Pneumatic supply plate: U, V, W

12 Electrical supply plate: L

Module position

0	1	2	3	4	5	6	7	8	9	10	11	12	13	14	15	16
M	A	A	A	A	A	U										

7 + 8 + 9 + 10 + 11 + 12

**Ordering table**

Size	1	2	Condi- tions	Code	Enter code	
<b>M</b>	Pneumatic module blocks 0 ... 16			-	-	
<b>7</b>	Type of interlinking block 0 ... 16				Enter equip- ment selection for mod- ule posi- tions in order code	
	Pneumatic interface		[2]	<b>M</b>		
	Sub-base for size 1		[3] [4]	<b>A</b>		
	Sub-base for size 2		[4] [5]	<b>B</b>		
<b>8</b>	Electrical module for block 1 ... 16		[6]	<b>H</b>		
	<b>9</b>	Duct separation in interlinking block 1 ... 16		[7]		<b>I</b>
		<b>10</b>	Duct separation for block 0 ... 15			[7]
Seal with duct separation 1			[7]	<b>T</b>		
Seal with duct separation 3, 5			[7]	<b>R</b>		
<b>11</b>	Pneumatic supply plate for block 1 ... 16		[8]	<b>U</b>		
	Supply plate with separating seal on left		[9]	<b>V</b>		
	Supply plate with separating seal on right		[9]	<b>W</b>		
<b>12</b>	Electrical supply plate for block 0 ... 16		[10]	<b>L</b>		

[2] **M** Only on block 0

[3] **A** 4 valve positions. Occupies 8 digital outputs

[4] **A, B** Each connection block must be fully equipped.

Module blocks A or B must not be used without electrical module, electrically isolated H to the right of an electrical supply plate L or if an interlinking block with valve supply V, QP or QV was selected in the CPX part.

Max. 47 consuming devices can be selected. Consuming devices are as follows:

Interlinking blocks A (sub-base for size 1), B (sub-base for size 2), M (pneumatic interface), I (separation duct 1)

[5] **B** 2 valve positions. Occupies 4 digital outputs

[6] **H** Electrical supply plate L must be selected before the first H, unless the entire valve terminal has only module blocks with electrical module, electrically isolated H

[7] **I, S, T, R**

If a duct is separated, a pneumatic supply plate U, V or W must be selected to the right of it before the next duct separation of the same duct or before the right-hand end plate

[8] **U** Must be selected if no separating seal R, S or T was selected

[9] **V, W** Must be selected if separating seal R, S or T was selected

[10] **L** Only module blocks with electrical module, electrically isolated H may be selected to the right of an electrical supply plate L.

At least one electrical supply plate L must be selected after each group of 8 connection blocks.

A maximum of 8 electrical supply plates L may be selected per valve terminal

**Transfer order code**

Module position

0	1	2	3	4	5	6	7	8	9	10	11	12	13	14	15	16

7 + 8 + 9 + 10 + 11 + 12

# Valve terminals type 32 MPA – Pneumatic part CPX

Ordering data – Modular products



Valve terminals for standard applications  
Heavy-duty modular

## 2.2

[M] Mandatory data	[O] Options																																																																		
<p><b>Pneumatic valve positions 0 ... 64</b></p> <p>M, J, N, K, H, B, G, E, D, I, X, W, L</p> <p>Valve position</p> <table style="width: 100%; border-collapse: collapse; font-size: small;"> <tr> <td style="text-align: center;">0</td><td style="text-align: center;">1</td><td style="text-align: center;">2</td><td style="text-align: center;">3</td><td style="text-align: center;">4</td><td style="text-align: center;">5</td><td style="text-align: center;">6</td><td style="text-align: center;">7</td><td style="text-align: center;">8</td><td style="text-align: center;">9</td><td style="text-align: center;">10</td><td style="text-align: center;">11</td><td style="text-align: center;">12</td><td style="text-align: center;">13</td><td style="text-align: center;">14</td><td style="text-align: center;">15</td><td style="text-align: center;">16</td><td style="text-align: center;">17</td><td style="text-align: center;">18</td><td style="text-align: center;">19</td><td style="text-align: center;">20</td><td style="text-align: center;">21</td><td style="text-align: center;">22</td><td style="text-align: center;">23</td><td style="text-align: center;">24</td><td style="text-align: center;">25</td><td style="text-align: center;">26</td><td style="text-align: center;">27</td><td style="text-align: center;">28</td><td style="text-align: center;">29</td><td style="text-align: center;">...</td><td style="text-align: center;">64</td> </tr> <tr> <td style="text-align: center;">M</td><td style="text-align: center;">M</td><td style="text-align: center;">M</td><td style="text-align: center;">M</td><td style="text-align: center;">M</td><td style="text-align: center;">M</td><td style="text-align: center;">M</td><td style="text-align: center;">M</td><td style="text-align: center;">M</td><td style="text-align: center;">M</td><td style="text-align: center;">M</td><td style="text-align: center;">M</td><td style="text-align: center;">M</td><td style="text-align: center;">M</td><td style="text-align: center;">M</td><td style="text-align: center;">M</td><td style="text-align: center;">M</td><td style="text-align: center;">M</td><td style="text-align: center;">M</td><td style="text-align: center;">M</td><td style="text-align: center;">M</td><td style="text-align: center;">M</td><td style="text-align: center;">M</td><td style="text-align: center;">M</td><td style="text-align: center;">M</td><td style="text-align: center;">M</td><td style="text-align: center;">M</td><td style="text-align: center;">M</td><td style="text-align: center;">M</td><td style="text-align: center;">M</td><td style="text-align: center;">M</td><td style="text-align: center;">M</td><td style="text-align: center;">M</td><td style="text-align: center;">M</td> </tr> </table>	0	1	2	3	4	5	6	7	8	9	10	11	12	13	14	15	16	17	18	19	20	21	22	23	24	25	26	27	28	29	...	64	M	M	M	M	M	M	M	M	M	M	M	M	M	M	M	M	M	M	M	M	M	M	M	M	M	M	M	M	M	M	M	M	M	M	<p><b>Pneumatic accessories</b></p> <p>...T, ...J</p>
0	1	2	3	4	5	6	7	8	9	10	11	12	13	14	15	16	17	18	19	20	21	22	23	24	25	26	27	28	29	...	64																																				
M	M	M	M	M	M	M	M	M	M	M	M	M	M	M	M	M	M	M	M	M	M	M	M	M	M	M	M	M	M	M	M	M	M																																		
- 13	+ 5T1J 14																																																																		

Ordering table					
Size	1	2	Condi-tions	Code	Enter code
[M] 13	Pneumatic valve positions 0 ... 64			-	-
	Valves		5/2-way valve, single solenoid	M	Enter equip-ment selection for valve positions in order code
			5/2-way valve, double solenoid	J	
			2x 3/2-way valve, normally open	N	
			2x 3/2-way valve, normally closed	K	
			2x 3/2-way valve, 1x normally open, 1x closed	H	
			5/3-way valve, mid-position pressurised	B	
			5/3-way valve, mid-position closed	G	
			5/3-way valve, mid-position exhausted	E	
			2x 2/2-way valve, normally closed	D	
			2x 2/2-way valve, 1x normally closed and 1x normally closed, reversible	I	
			3/2-way valve, normally closed, external supply air	X	
			3/2-way valve, normally open, external supply air	W	
			Blanking plate	L	
[O] 14	Pneumatic accessories			+	+
	Inscription label per manifold sub-base		1 ... 99	...T	
	Mounting bracket for additional wall mounting		1 ... 99	[11] ...J	

[11] J Can only be selected if at least one pneumatic supply plate U, V or W is used

### Transfer order code

Valve position

0	1	2	3	4	5	6	7	8	9	10	11	12	13	14	15	16	17	18	19	20	21	22	23	24	25	26	27	28	29	...	64	
-	-	-	-	-	-	-	-	-	-	-	-	-	-	-	-	-	-	-	-	-	-	-	-	-	-	-	-	-	-	-	-	-
													-																+			
													13																14			



# Valve terminals type 32 MPA

Ordering data – Individual valve

FESTO

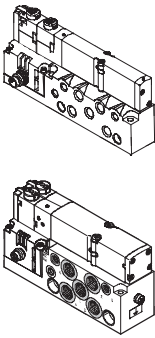
Ordering data					
Valves on individual sub-base					
	Code	Valve function	Type	Part No.	
	Internal pilot air				
	M	5/2-way valve, single solenoid	VMPA1-M1H-M7-PI VMPA2-M1H-M-G $\frac{1}{8}$ -PI	533 376 537 963	
	J	5/2-way valve, double solenoid	VMPA1-M1H-J-M7-PI VMPA2-M1H-J-G $\frac{1}{8}$ -PI	533 377 537 964	
	N	2x 3/2-way valve, normally open	VMPA1-M1H-N-M7-PI VMPA2-M1H-N-G $\frac{1}{8}$ -PI	533 382 537 969	
	K	2x 3/2-way valve, normally closed	VMPA1-M1H-K-M7-PI VMPA2-M1H-K-G $\frac{1}{8}$ -PI	533 381 537 968	
	H	2x 3/2-way valve, 1x normally open 1x normally closed	VMPA1-M1H-H-M7-PI VMPA2-M1H-H-G $\frac{1}{8}$ -PI	533 383 537 970	
	B	5/3-way valve, mid-position pressurised	VMPA1-M1H-B-M7-PI VMPA2-M1H-B-G $\frac{1}{8}$ -PI	533 378 537 965	
	G	5/3-way valve, mid-position closed	VMPA1-M1H-G-M7-PI VMPA2-M1H-G-G $\frac{1}{8}$ -PI	533 379 537 966	
	E	5/3-way valve, mid-position exhausted	VMPA1-M1H-E-M7-PI VMPA2-M1H-E-G $\frac{1}{8}$ -PI	533 380 537 967	
	D	2x 2/2-way valve, normally closed	VMPA1-M1H-D-M7-PI VMPA2-M1H-D-G $\frac{1}{8}$ -PI	533 384 537 971	
	I	2x 2/2-way valve, normally closed	VMPA1-M1H-I-M7-PI VMPA2-M1H-I-G $\frac{1}{8}$ -PI	545 230 545 232	
	External pilot air				
	M	5/2-way valve, single solenoid	VMPA1-M1H-MS-M7-PI VMPA2-M1H-MS-G $\frac{1}{8}$ -PI	533 385 537 972	
	J	5/2-way valve, double solenoid	VMPA1-M1H-JS-M7-PI VMPA2-M1H-JS-G $\frac{1}{8}$ -PI	533 386 537 973	
	N	2x 3/2-way valve, normally open	VMPA1-M1H-NS-M7-PI VMPA2-M1H-NS-G $\frac{1}{8}$ -PI	533 391 537 978	
	K	2x 3/2-way valve, normally closed	VMPA1-M1H-KS-M7-PI VMPA2-M1H-KS-G $\frac{1}{8}$ -PI	533 390 537 977	
	H	2x 3/2-way valve, 1x normally open 1x normally closed	VMPA1-M1H-HS-M7-PI VMPA2-M1H-HS-G $\frac{1}{8}$ -PI	533 392 537 979	
	B	5/3-way valve, mid-position pressurised	VMPA1-M1H-BS-M7-PI VMPA2-M1H-BS-G $\frac{1}{8}$ -PI	533 387 537 974	
	G	5/3-way valve, mid-position closed	VMPA1-M1H-GS-M7-PI VMPA2-M1H-GS-G $\frac{1}{8}$ -PI	533 388 537 975	
	E	5/3-way valve, mid-position exhausted	VMPA1-M1H-ES-M7-PI VMPA2-M1H-ES-G $\frac{1}{8}$ -PI	533 389 537 976	
D	2x 2/2-way valve, normally closed	VMPA1-M1H-DS-M7-PI VMPA2-M1H-DS-G $\frac{1}{8}$ -PI	533 393 537 980		
I	2x 2/2-way valve, normally closed	VMPA1-M1H-IS-M7-PI VMPA2-M1H-IS-G $\frac{1}{8}$ -PI	545 231 545 233		

Valve terminals for standard applications  
Heavy-duty modular

2.2









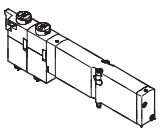
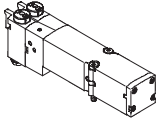

# Valve terminals type 32 MPA

Accessories

FESTO

Valve terminals for standard applications  
Heavy-duty modular

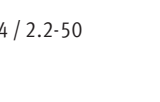

2.2

Ordering data				
Individual sub-base valve				
	Code	Valve function	Electrical plug-in connection	
			Type	Part No.
	M	5/2-way valve, single solenoid	VMPA1-M1H-M-PI	533 342
			VMPA2-M1H-M-PI	537 952
	J	5/2-way valve, double solenoid	VMPA1-M1H-J-PI	533 343
			VMPA2-M1H-J-PI	537 953
	N	2x 3/2-way valve, normally open	VMPA1-M1H-N-PI	533 348
			VMPA2-M1H-N-PI	537 958
	W	1x 3/2-way valve, normally open, external compressed air supply	VMPA1-M1H-W-PI	540 050
			VMPA2-M1H-W-PI	540 051
	K	2x 3/2-way valve, normally closed	VMPA1-M1H-K-PI	533 347
			VMPA2-M1H-K-PI	537 957
	H	2x 3/2-way valve, 1x normally open 1x normally closed	VMPA1-M1H-H-PI	533 349
			VMPA2-M1H-H-PI	537 959
	B	5/3-way valve, mid-position pressurised	VMPA1-M1H-B-PI	533 344
			VMPA2-M1H-B-PI	537 954
	G	5/3-way valve, mid-position closed	VMPA1-M1H-G-PI	533 345
			VMPA2-M1H-G-PI	537 955
	E	5/3-way valve, mid-position exhausted	VMPA1-M1H-E-PI	533 346
			VMPA2-M1H-E-PI	537 956
	X	1x 3/2-way valve, normally closed, external compressed air supply	VMPA1-M1H-X-PI	534 415
			VMPA2-M1H-X-PI	537 961
	D	2x 2/2-way valve, normally closed	VMPA1-M1H-D-PI	533 350
			VMPA2-M1H-D-PI	537 960
	I	2x 2/2-way valve, normally closed	VMPA1-M1H-I-PI	543 605
			VMPA2-M1H-I-PI	543 703

# Valve terminals type 32 MPA

Accessories

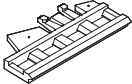
FESTO

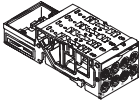
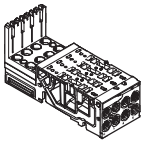
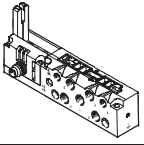
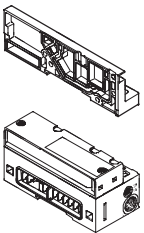
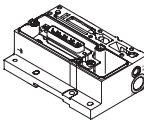
Ordering data				
Designation			Type	Part No.
<b>Inscription labels</b>				
	Inscription label holder for manifold block, transparent, for paper foil label		VMPA1-ST-1-4	533 362
	Inscription label holder for manifold block, 4-fold, for IBS.6x10		VMPA1 ST 2-4	544 384
	Inscription labels 6 x 10 in frame, 64 pieces		IBS-6x10	18 576
<b>Mounting</b>				
	For H-rail	MPA with fieldbus	CPX-CPA-BG-NRH	526 032
	For H-rail	MPA with multi-pin plug connection	CPA-BG-NRH	173 498
	Mounting bracket		VMPA-BG-RW	534 416
<b>Manifold sub-bases – without electrical components</b>				
	For multi-pin plug/fieldbus	MPA1, four valve positions	VMPA1-FB-AP-4-1	533 352
	For multi-pin plug/fieldbus	MPA2, two valve positions	VMPA2-FB-AP-2-1	538 000
	For multi-pin plug/fieldbus, duct 1 closed	MPA1, four valve positions	VMPA1-FB-AP-4-1-T1	538 657
	For multi-pin plug/fieldbus, duct 1 closed	MPA2, two valve positions	VMPA2-FB-AP-2-1-T0	538 677
<b>Manifold sub-bases – incl. electrical manifold module and electronics module</b>				
	For fieldbus	MPA1, four valve positions	VMPA1-AP-4-1-EMS-8	546 802
		MPA2, two valve positions	VMPA2-AP-2-1-EMS-4	546 803
	For multi-pin plug	MPA1, four solenoid coils	VMPA1-AP-4-1-EMM-4	546 806
		MPA2, two solenoid coils	VMPA2-AP-2-1-EMM-2	546 807
		MPA1, eight solenoid coils	VMPA1-AP-4-1-EMM-8	546 804
		MPA2, four solenoid coils	VMPA2-AP-2-1-EMM-4	546 805
<b>Manifold sub-bases – for individual connection</b>				
	Internal pilot air	MPA1	VMPA1-IC-AP-1	533 394
		MPA2	VMPA2-IC-AP-1	537 981
	External pilot air	MPA1	VMPA1-IC-AP-S-1	533 395
		MPA2	VMPA2-IC-AP-S-1	537 982
<b>End plates and fieldbus pneumatic interface</b>				
	Right-hand end plate		VMPA-EPR	533 373
	Pneumatic interface, ducted exhaust air, internal pilot air		VMPA-FB-EPL-G	533 370
	Pneumatic interface, ducted exhaust air, external pilot air		VMPA-FB-EPL-E	533 369
	Pneumatic interface, flat plate silencer, internal pilot air		VMPA-FB-EPL-GU	533 372
	Pneumatic interface, flat plate silencer, external pilot air		VMPA-FB-EPL-EU	533 371
<b>Electrical interface for multi-pin plug connection</b>				
	External pilot air, ducted exhaust air		VMPA1-MPM-EPL-E	540 893
	Internal pilot air, ducted exhaust air		VMPA1-MPM-EPL-G	540 894
	External pilot air, silencer		VMPA1-MPM-EPL-EU	540 895
	Internal pilot air, silencer		VMPA1-MPM-EPL-GU	540 896

Valve terminals for standard applications  
Heavy-duty modular

2.2





# Valve terminals type 32 MPA

Accessories

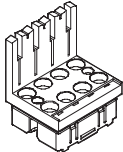
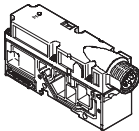
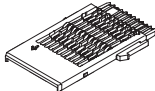
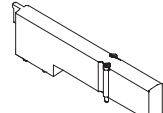

Valve terminals for standard applications  
Heavy-duty modular

2.2

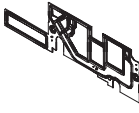

Ordering data					
Designation			Type	Part No.	
<b>Electronics module</b>					
	For fieldbus connection, not electrically isolated, standard	4 coils MPA2	VMPA2-FB-EMS-4	537 983	
		8 coils MPA1	VMPA1-FB-EMS-8	533 360	
	For fieldbus connection, electrically isolated	4 coils MPA2	VMPA2-FB-EMG-4	537 984	
		8 coils MPA1	VMPA-FB-EMG-8	533 361	
	For modular multi-pin plug connection (MPM)	2 coils MPA2	VMPA2-MPM-EMM-2	537 985	
		4 coils MPA2	VMPA2-MPM-EMM-4	537 986	
		4 coils MPA1	VMPA1-MPM-EMM-4	537 987	
8 coils MPA1		VMPA1-MPM-EMM-8	537 988		
<b>Electrical supply plate</b>					
	Plug connection M18, 3-pin		VMPA-FB-SP-V	541 082	
	Plug connection 7/8", 5-pin		VMPA-FB-SP-7/8-V-5POL	541 083	
	Plug connection 7/8", 4-pin		VMPA-FB-SP-7/8-V-4POL	541 084	
<b>Electrical manifold module</b>					
	• For connection module for multi-pin plug connection	2 coils MPA2	VMPA2-MPM-EV-AB-2	537 989	
		4 coils MPA1, MPA2	VMPA1-MPM-EV-AB-4	537 993	
		8 coils MPA1	VMPA1-MPM-EV-AB-8	537 994	
	• For connection module for multi-pin plug connection • For pneumatic supply plate	2 coils MPA2	VMPA2-MPM-EV-ABV-2	537 991	
		4 coils MPA1, MPA2	VMPA1-MPM-EV-ABV-4	537 995	
		8 coils MPA1	VMPA1-MPM-EV-ABV-8	537 996	
	• For fieldbus connection	Manifold sub-base MPA1 and MPA2	VMPA1-FB-EV-AB	537 998	
		Pneumatic supply plate	VMPA1-FB-EV-V	537 999	
	<b>Cover</b>				
		Blanking plate for vacant valve position <sup>1)</sup>		VMPA1-RP	533 351
			VMPA2-RP	537 962	
	Cover for manual override, pushing (10 pieces)		VMPA1-HBT	533 366	
	Cover for manual override, covered (10 pieces)		VMPA1-HBV	535 257	
	Cover for manual override, pushing (10 pieces)		VMPA-HBT-B	540 897	
	Cover for manual override, covered (10 pieces)		VMPA-HBV-B	540 898	
<b>Seals for manifold block</b>					
	MPA with ducted exhaust air	No duct separation	VMPA1-DP	533 359	
		Duct 1 separated	VMPA1-DP-P	533 363	
		Duct 3/5 separated	VMPA1-DP-RS	533 364	
		Duct 1 and 3/5 separated	VMPA1-DP-PRS	533 365	
	MPA with flat plate silencer	No duct separation	VMPA1-DPU	533 355	
		Duct 1 separated	VMPA1-DPU-P	533 356	
		Duct 3/5 separated	VMPA1-DPU-RS	533 357	
		Duct 1 and 3/5 separated	VMPA1-DPU-PRS	533 358	

1) A self-adhesive label is supplied.

# Valve terminals type 32 MPA

Accessories

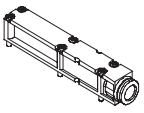
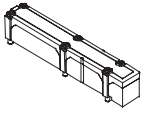
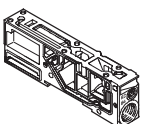
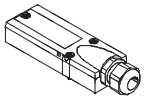
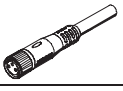
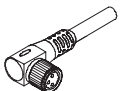
FESTO

Ordering data				
Designation			Type	Part No.
<b>Exhaust plate</b>				
	For ducted exhaust air, with 10 mm push-in connector		VMPA-AP	533 375
	For flat plate silencer		VMPA-APU	533 374
<b>Supply plates (without exhaust plate)</b>				
	For ducted exhaust air		VMPA1-FB-SP	533 354
	For flat plate silencer		VMPA1-FB-SPU	533 353
<b>Multi-pin plug connection, electrical</b>				
	Cover without connecting cable for self-assembly		VMPA-KMS-H	533 198
	PVC connecting cable for 8 solenoid coils	2.5 m	VMPA-KMS1-8-2,5	533 195
		5 m	VMPA-KMS1-8-5	533 196
		10 m	VMPA-KMS1-8-10	533 197
	PVC connecting cable for 24 solenoid coils	2.5 m	VMPA-KMS1-24-2,5	533 192
		5 m	VMPA-KMS1-24-5	533 193
		10 m	VMPA-KMS1-24-10	533 194
	PUR connecting cable for 8 solenoid coils, suitable for chain link trunking	2.5 m	VMPA-KMS2-8-2,5-PUR	533 504
		5 m	VMPA-KMS2-8-5-PUR	533 505
		10 m	VMPA-KMS2-8-10-PUR	533 506
	PUR connecting cable for 24 solenoid coils, suitable for chain link trunking	2.5 m	VMPA-KMS2-24-2,5-PUR	533 501
		5 m	VMPA-KMS2-24-5-PUR	533 502
10 m		VMPA-KMS2-24-10-PUR	533 503	
<b>Individual electrical connection</b>				
	Plug socket with cable	2.5 m	SIM-M8-4GD-2,5-PU	158 960
		5 m	SIM-M8-4GD-5-PU	158 961
	Angled plug socket with cable	2.5 m	SIM-M8-4WD-2,5-PU	158 962
		5 m	SIM-M8-4WD-5-PU	158 963
<b>Push-in fitting for manifold block, pneumatic interface, supply plate</b>				
	Connecting thread M5 for tubing O.D.	3 mm (10 pieces)	QSM-M5-3-I	153 313
		4 mm (10 pieces)	QSM-M5-4-I	153 315
		6 mm (10 pieces)	QSM-M5-6-I	153 317
	Connecting thread M7 for tubing O.D.	4 mm (10 pieces)	QSM-M7-4-I	153 319
		6 mm (10 pieces)	QSM-M7-6-I	153 321
	Connecting thread G $\frac{1}{8}$ for tubing O.D.	6 mm (10 pieces)	QS-G $\frac{1}{8}$ -6-I	186 107
		8 mm (10 pieces)	QS-G $\frac{1}{8}$ -8-I	186 109
	Connecting thread G $\frac{1}{4}$ for tubing O.D.	8 mm (10 pieces)	QS-G $\frac{1}{4}$ -8-I	186 110
		10 mm (10 pieces)	QS-G $\frac{1}{4}$ -10-I	186 112

Valve terminals for standard applications  
Heavy-duty modular

2.2





# Valve terminals type 32 MPA

Accessories

**FESTO**

Valve terminals for standard applications  
Heavy-duty modular

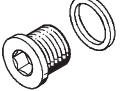
2.2

Ordering data				
Designation		Type	Part No.	
<b>Silencer</b>				
	Connecting thread	M5	UC-M5	165 003
		M7	UC-M7	161 418
		G $\frac{1}{4}$	UC- $\frac{1}{4}$	165 004
		G $\frac{1}{8}$	UC- $\frac{1}{8}$	161 419
	Push-in sleeve connection	3 mm	UC-QS-3H	165 005
		4 mm	UC-QS-4H	165 006
		6 mm	UC-QS-6H	165 007
		8 mm	UC-QS-8H	175 611
		10 mm	UC-QS-10H	526 475
<b>Blanking plug</b>				
	Thread M5	B-M5		3 843
			Thread M7	B-M7
Thread G $\frac{1}{8}$	B- $\frac{1}{8}$		3 568	
Thread G $\frac{1}{4}$	B- $\frac{1}{4}$		3 569	
<b>Plug</b>				
	Blanking plug for tubing O.D.	4 mm	QSC-4H	153 267
		6 mm	QSC-6H	153 268
		8 mm	QSC-8H	153 269
		10 mm	QSC-10H	153 270
<b>User documentation</b>				
	MPA user documentation	German	P.BE-MPA-DE	534 240
		English	P.BE-MPA-EN	534 241
		French	P.BE-MPA-FR	534 243
		Spanish	P.BE-MPA-ES	534 242
		Italian	P.BE-MPA-IT	534 244
		Swedish	P.BE-MPA-SV	534 245