

- Flexible and robust design
- Tried and trusted Tiger valves
- Wide choice of variants:
Multi-pin, fieldbus or integrated PLC
- Valve/sensor terminal with electrical inputs and two additional electrical outputs
- Relay outputs, upon request

Valve terminal type 02 VIMP/IIMP-02, Tiger 2000

Features

FESTO

Valve terminals for standard applications
Fixed-grid

2.3

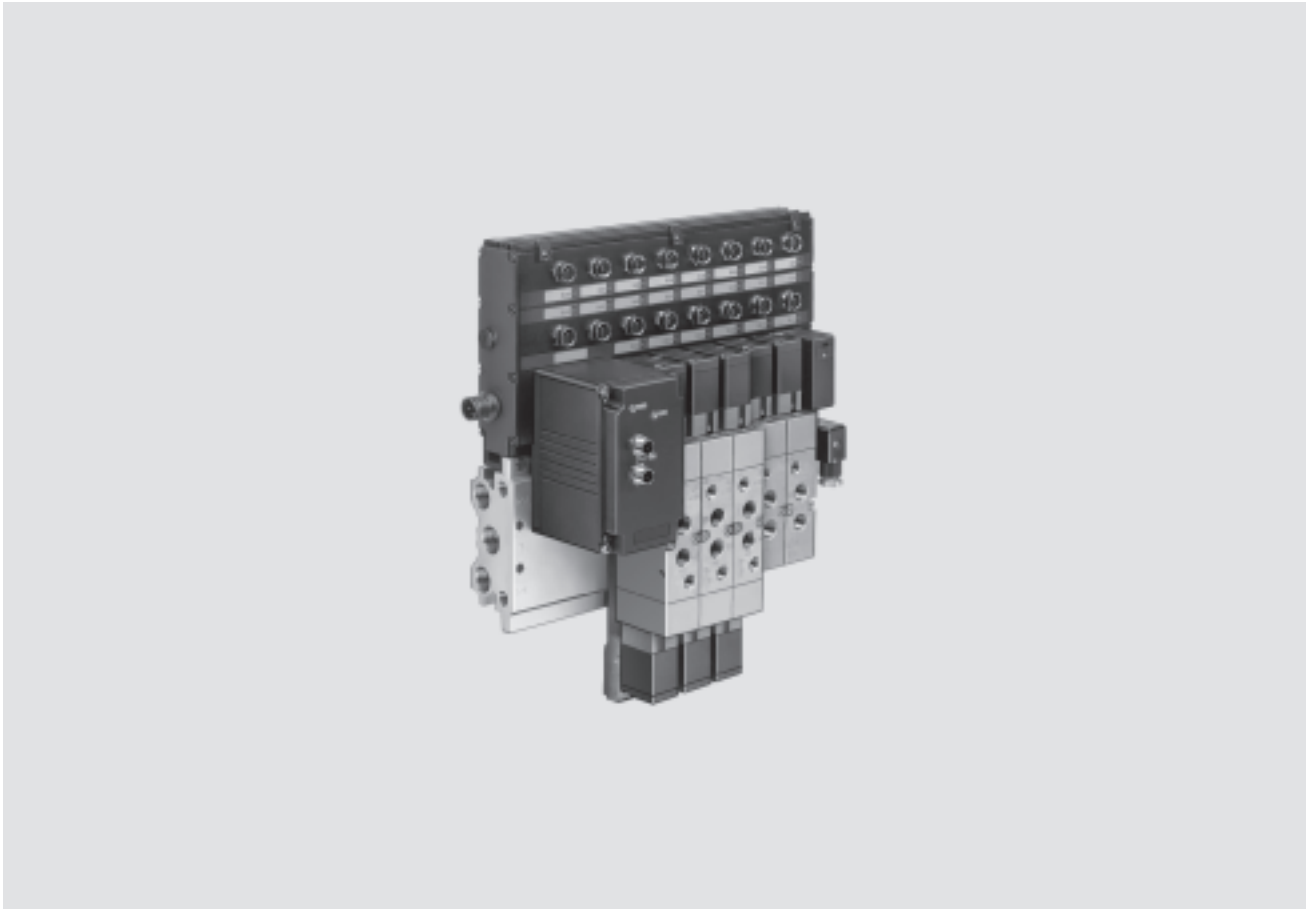

Valve/sensor terminal type 02 with Tiger valves

Reliable, flexible and sturdy:

For many years now the Tiger valve terminal type 02 has been the emblem for the world-wide success of intelligent pneumatics. The invention of valve terminals began with the Tiger series valves and they are still a success.

The success factors are a relatively flexible and sturdy design with many useful detail solutions and an unbeatable range of control variants.

The valve terminals are supplied fully checked and only need to be attached with 4 bolts – ready to go.

- Valve terminals with 4 to 16 valve positions, equipped according to customer requirements.
- Connection sizes:
 - G $\frac{1}{8}$
 - G $\frac{1}{4}$
- Valve/sensor terminal: Valve terminal with two sensor inputs per valve position and two additional universal inputs and two outputs per terminal (24 V/0.5 A).

- Protection class IP 65
- Fully assembled and 100 % tested before shipment.
- Sturdy Tiger valves, proven reliability.
- Long service life, even in aggressive environments.
- LED display and integrated protective circuit for each solenoid

-  - Note

Technical data on fieldbuses and control blocks can be found under Modular electrical peripherals type 03/04.

➔ 4 / 4.8-164

Valve terminal type 02 VIMP/IIMP-02, Tiger 2000

Features

General features			
Separate voltage supply for electronics and outputs. Outputs can be switched off separately.	and pilot exhaust for all valves. The common lines can be connected on both sides.	Valve equipment: Valves with or without auxiliary pilot air connection	Instead of a valve, a relay with 2 floating contacts can be chosen.
There is an option for using relay plates, blanking plates for spare positions and sealing plugs for two different pressure zones.	Manual override, LED for status display per valve and sensor input, integrated self-test function and diagnosis messages (with fieldbus nodes) allow for simple, fast start-up and convenient diagnostics.	Multiple valve functions <ul style="list-style-type: none"> • Single solenoid 5/2-way valves, • 5/2-way double solenoid valves • 5/3-way valves. 	The manual overrides of the valves are either pushing or detenting, and can be secured against unauthorised activation.
The manifold contains common lines for compressed air supply, exhaust		Valves with mechanical spring or pneumatic spring.	

Multi-pin plug connection			
Valve terminal VIMP-02-...	Valve/sensor terminal IIMP-02-...		
<ul style="list-style-type: none"> • 4 to 16 valve positions • Connection via Harting plug 24 V DC • 4 to 16 valves G$\frac{1}{8}$, G$\frac{1}{4}$ <p>Can be connected to all control systems</p>	<ul style="list-style-type: none"> • 4 to 16 valve positions • Equipped like a valve terminal, but: <ul style="list-style-type: none"> – Two additional sensor connections per valve position – Two additional electrical inputs 24 V and two outputs 24 V/0.5 A <p>Can be connected to all control systems</p>		

Fieldbus connection			
Valve terminal VIFB-02-...	Valve/sensor terminal IIFB-02-...		
<ul style="list-style-type: none"> • 4 to 16 valve positions • Connection to 24 V DC and fieldbus via special fieldbus plug • 4 to 16 valves G$\frac{1}{8}$, G$\frac{1}{4}$ <p>Can be connected to all major fieldbus systems</p>	<ul style="list-style-type: none"> • 4 to 14 valve positions • Equipped like a valve terminal, but: <ul style="list-style-type: none"> – Two additional sensor connections per valve position – Two additional electrical inputs 24 V and two outputs 24 V/0.5 A <p>Can be connected to all major fieldbus systems</p>		

Programmable with integrated PLC	
Valve/sensor terminal IIFB-02-...-SB-...	<ul style="list-style-type: none"> • 4 to 16 valve positions • Connection 24 V DC • 4 to 16 valves G$\frac{1}{8}$, G$\frac{1}{4}$ • Two additional sensor connections per valve position • Two additional electrical inputs 24 V and two outputs 24 V/0.5 A <p>Autonomous on-site control with integrated Festo PLC and Festo fieldbus connection</p>

Valve terminal type 02 VIMP/IIMP-02, Tiger 2000

Features

FESTO

Fieldbus variants

FESTO

DeviceNet

ABB

PROFIBUS

MOELLER 



 **Allen-Bradley**

Of the more than 20 different fieldbus systems (protocols) available in the market, some have emerged as the most important variants. Festo supports these by means of various fieldbus nodes (FBxx) on its valve terminals.

Fieldbus systems require a powerful, central PLC and a master interface adapted to that particular fieldbus. Fieldbus systems are generally used when several devices with many inputs/outputs, complex functions or high communication levels must be controlled. In this case, the advantages of simple cabling, easy diagnosis and maintenance outweigh the extra outlay for a fieldbus master interface and the necessary know-how.

Festo fieldbus:

A fieldbus developed by Festo with simple prompting, supported by the control systems in the FPC, SF and IPC series (Festo FB5).

A maximum of 98 bus stations can be connected to the Festo fieldbus. The bus can operate with 4 different baud rates. 31.25; 62.5; 187.75 and 375 kbps.

Interbus:

An open fieldbus standard, originally developed by Phoenix Contact and now in world-wide use. Important installation accessories such as bus plugs must be obtained from Phoenix or its partners (Festo FB6).

Profibus-DP:

An open fieldbus standard, originally developed by Siemens and in world-wide use. (Festo FB13 for 12 MBd).

DeviceNet:

An open fieldbus system based on CAN technology originally developed for the automotive sector. DeviceNet was originally sold by Rockwell (Allen-Bradley). Other CAN derivatives are available as well (Festo FB11).

Moeller SUCONET K:

A maximum of 98 bus stations can be connected to the SUCONET K fieldbus. The bus operates with a baud rate of 187.5 or 375 kbps, depending on the design, bus length, etc. The bus interface is based on RS 485 with a master/slave structure (Festo FB5).

ABB CS31:

The fieldbus from ABB connects a maximum of 63 fieldbus stations to the fieldbus master. The data is transferred at a constant baud rate of 187.5 kbps. The protocol is suitable for use in all areas of automation technology (Festo FB5).

Integrated Festo PLC

A powerful mini controller from Festo was integrated into the SF3 valve terminal node. This enables stand alone control of up to 34 inputs and 34 outputs on site with protection class IP65 – no need for a control cabinet. With the Festo fieldbus, additional I/Os and expanded functions can be installed and

controlled – this creates a programmable valve/sensor terminal.

The SF3 control block can be operated as required as a stand-alone, fieldbus master or fieldbus slave. 31 slaves with up to 1,048 inputs and outputs can be controlled via the fieldbus in the master operation mode.

The SF3 node can be used as an intelligent slave within the fieldbus in the slave operation mode. This enables stand alone on site pre-processing or a partial startup.

Start/stop signals to synchronise with other processes or controllers via the

additional electrical inputs and outputs.

The SF3 valve terminal can be programmed with FST 200 or a display and control device can be directly connected on-site via an RS 232 programming interface.

Valve terminal type 02 VIMP/IIMP-02, Tiger 2000

Key features – Pneumatics

Valve function				
Code	Circuit symbols	Connection		Description
		G1/8	G1/4	
M		■	■	5/2-way solenoid valve
V		■	■	5/2-way solenoid valve with auxiliary pilot air
L		■	■	5/2-way solenoid valve with pneumatic spring
P		■	■	5/2-way solenoid valve with pneumatic spring and auxiliary pilot air
J		■	■	5/2-way double solenoid valve
K		■	■	5/2-way double solenoid valve with auxiliary pilot air
G		■	■	5/3-way solenoid valve Mid-position closed
O		■	■	5/3-way solenoid valve Mid-position closed with auxiliary pilot air
E		■	■	5/3-way solenoid valve Mid-position exhausted
F		■	■	5/3-way solenoid valve Mid-position exhausted with auxiliary pilot air
B		■	■	5/3-way solenoid valve Mid-position pressurised
C		■	■	5/3-way solenoid valve Mid-position pressurised with auxiliary pilot air

Valve terminal type 02 VIMP/IIMP-02, Tiger 2000

Key features – Mounting



Wall mounting, valve terminal

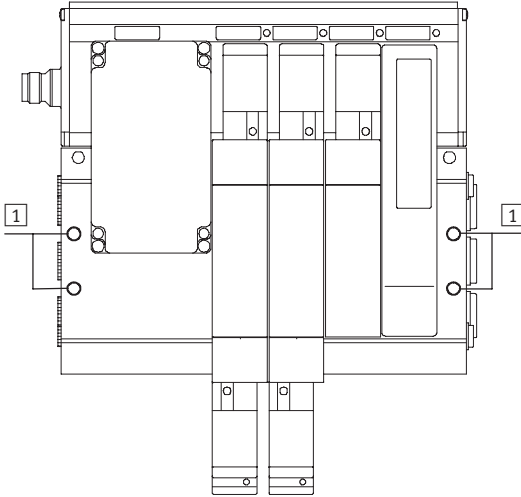

1 Mounting through holes for M6 hexagonal-head bolts

There are 4 through holes positioned on the right and left edges (1) of the connection block to facilitate attachment of the valve/sensor terminal.

- Make four through holes on the mounting surface.
- Attach the valve/sensor terminal to the mounting surface using M6x60 screws.

Valve terminal type 02 VIMP/IIMP-02, Tiger 2000

Key features – Display and operation

Operation and display components

Valve terminal

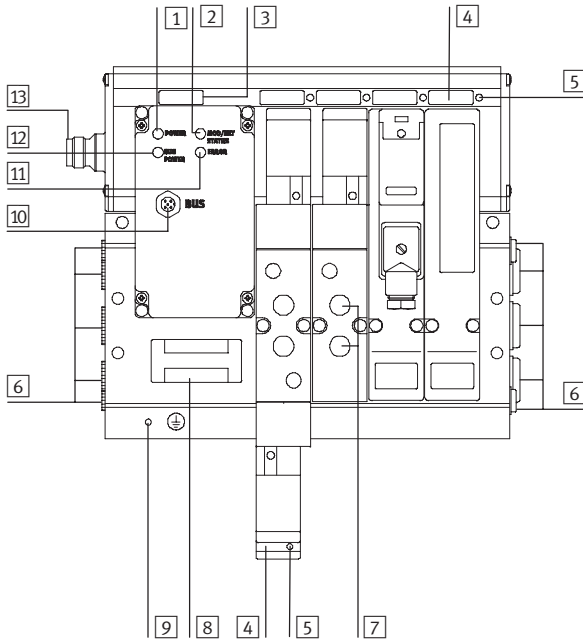

- 1 Green LED (POWER)
- 2 Bus-specific LED
- 3 Inscription field – Valve terminal
- 4 Inscription field – Valve position (per valve solenoid coil)
- 5 Yellow LED (per valve solenoid coil)
- 6 Common connections
- 7 Working line connections (per valve)
- 8 Rating plate
- 9 Earth terminal (M4 threads)
- 10 Fieldbus interface
- 11 Bus-specific LED
- 12 Bus-specific LED
- 13 Operating voltage connection

Valve/sensor terminal

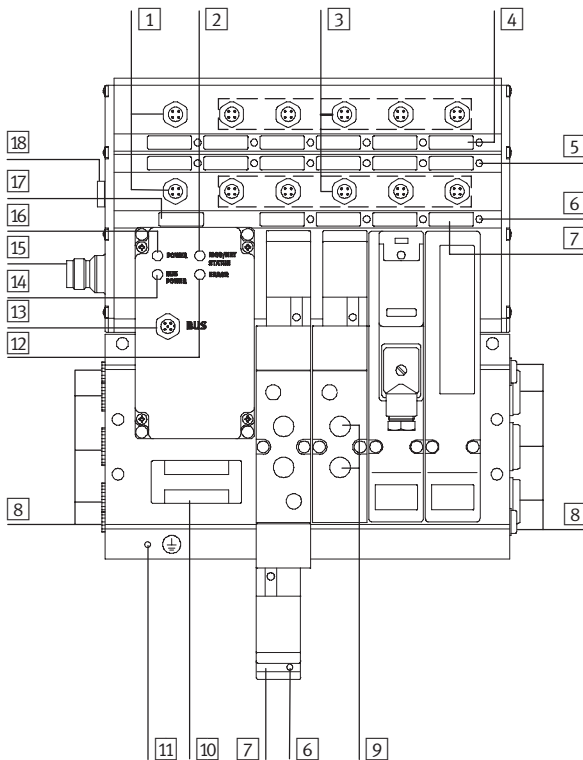

- 1 Connections for additional outputs
- 2 Bus-specific LED
- 3 Connections for inputs (e.g. sensors)
- 4 Inscription field for inputs and/or additional outputs (per connection)
- 5 Yellow or green LED (per input or additional output respectively)
- 6 Yellow LED (per valve solenoid coil)
- 7 Inscription field – Valve position (per valve solenoid coil)
- 8 Common connections
- 9 Working line connections (per valve)
- 10 Rating plate
- 11 Earth terminal (M4 threads)
- 12 Bus-specific LED
- 13 Fieldbus interface
- 14 Bus-specific LED
- 15 Operating voltage connection
- 16 Green LED (Power)
- 17 Inscription field – Valve/sensor terminal
- 18 Common fuse for inputs

Valve terminal type 02 VIMP/IIMP-02, Tiger 2000

Key features – Display and operation

FESTO

Manual override (MO)

Manual override with automatic return (non-locking)

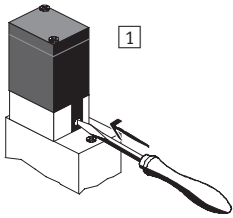

- 1 Press in the stem of the MO with a pin or a screwdriver.
→ Valve and/or process unit is activated.

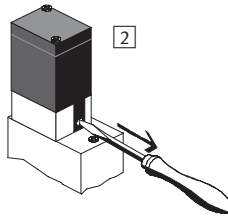

- 2 Remove the pin or screwdriver. The spring force pushes the stem of the MO back.
→ Valve and/or process unit returns to the initial position.

MO with detent

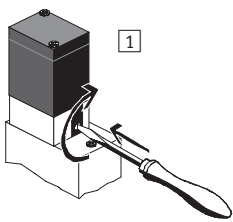

- 1 Press in the stem of the MO with the blade of a screwdriver until the valve switches and then turn to the right (clockwise).
→ Valve and/or process unit remains activated.

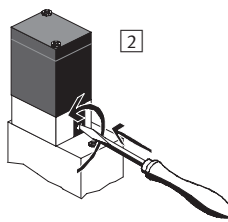

- 2 Press in the stem with the blade of a screwdriver and turn to the left (anti-clockwise). Remove the blade of the screwdriver. The spring force pushes the stem of the MO back.
→ Valve and/or process unit returns to the initial position.

Valve terminal type 02 VIMP/IIMP-02, Tiger 2000

Key features – Electrics



Pin allocation

Sensor inputs PNP (input and/or sensor connection)

Sockets (PNP) type 02

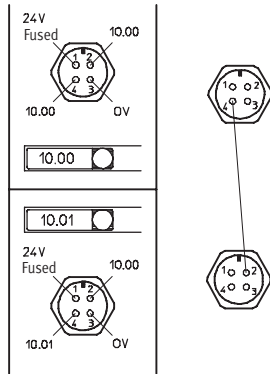

Two inputs (e.g. I0.00 and I0.01) are available on the lower plug, this

- reduces cable requirements (e.g. using DUO cable)
- Enables connection of changeover switch or selector switch

If you use the lower plug for two inputs, the upper socket must remain unused.

Additional outputs

Sockets (PNP)

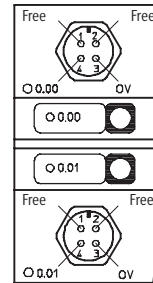

Power supply (only with fieldbus nodes and control blocks)



- Pin1: 24 V supply
Electronics + sensors
Tolerance: $\pm 25\%$
- Pin2: 24 V supply
Outputs
Tolerance: $\pm 10\%$
- Pin3: 0 V
- Pin4: Earth terminal

Valve terminals for standard applications
Fixed-grid

2.3

Valve terminal type 02 VIMP/IIMP-02, Tiger 2000

Key features – Electrics



Multi-pin connector plug – Valve terminal

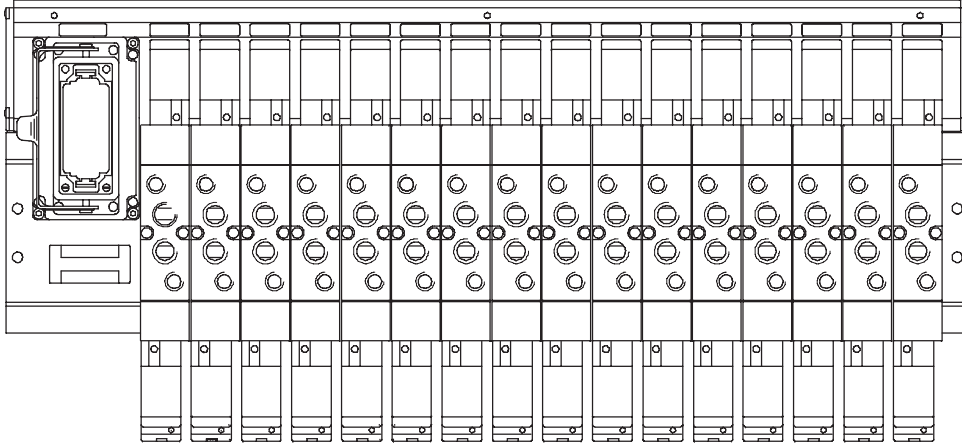

Pin allocation – Multi-pin connector plug - Valve terminal

Connector view (top view)	A	B	C	D	Remarks	
Multi-pin connector, 25-pin						
	1	0.00		1.00	Max. 12 valve positions 25-pin multi connector plug to DIN 43 652 Connecting cable 12 x 0.75 mm ² (4) 15 x 0.75 mm ² (6) 18 x 0.75 mm ² (8) 25 x 0.75 mm ² (10/12)	
	2	0.01	0.09	1.01		
	3	0.02	0.10	1.02		
	4	0.03	0.11	1.03		
	5	0.04	0.12	1.04		
	6	0.05	0.13	1.05		
	7	0.06	0.14	1.06		
	8	0.07	0.15	1.07		
	9	0.08		1) ¹⁾		
Output (solenoid valve position)						
Multi-pin connector, 40-pin						
	1	0.00	0.10	1.04	1.14	14 to 16 valve positions 40-pin multi connector plug to DIN 43 652 Connecting cable 41 x 0.75 mm ²
	2	0.01	0.11	1.05	1.15	
	3	0.02	0.12	1.06	–	
	4	0.03	0.13	1.07	–	
	5	0.04	0.14	1.08	–	
	6	0.05	0.15	1.09	–	
	7	0.06	1.00	1.10	–	
	8	0.07	1.01	1.11	–	
	9	0.08	1.02	1.12	1) ¹⁾	
	10	0.09	1.03	1.13	1) ¹⁾	
Output (solenoid valve position)						

1) Return line (output)

Valve terminal type 02 VIMP/IIMP-02, Tiger 2000

Key features – Electrics



Multi-pin connector plug, valve/sensor terminal

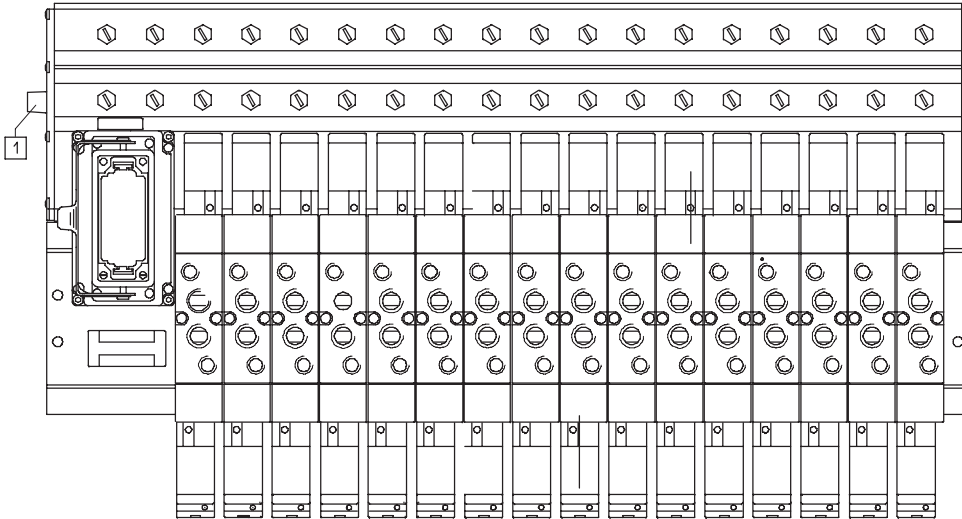

1 Protection T3A/250 V

Pin allocation – Multi-pin connector plug - Valve/sensor terminal

Connector view (top view)	A	B	C	D	Remarks	
Multi-pin connector, 25-pin						
	1	00.00		I0.06	Max. 4 valve positions 25-pin multi connector plug to DIN 43 652 Connecting cable 24 x 0.75 mm ²	
	2	00.01	00.09	I0.07		
	3	00.02	I0.10	I0.08		
	4	00.03	I0.11	I0.09		
	5	00.04	I0.12	–		
	6	00.05	I0.13	–		
	7	00.06	I0.14	24 V		
	8	00.07	I0.15	0 V		
	9	00.08		1)		
	Output (solenoid valve position)		Input			
Multi-pin connector, 40-pin						
	1	00.00	00.10	I0.00	I0.10	6 to 8 valve positions 40 pin multi connector plug Connecting cable 41 x 0.75 mm ²
	2	00.01	00.11	I0.01	I0.11	
	3	00.02	00.12	I0.02	I0.12	
	4	00.03	00.13	I0.03	I0.13	
	5	00.04	00.14	I0.04	I0.14	
	6	00.05	00.15	I0.05	I0.15	
	7	00.06	01.00	I0.06	I1.00	
	8	00.07	01.01	I0.07	I1.01	
	9	00.08	–	I0.08	24 V	
	10	00.09	COMMON	I0.09	0 V	
Output (solenoid valve position)		Input				

1) Return line (output)
24 V, 0 V supply (input, protection T 3.15 A)

Valve terminal type 02 VIMP/IIMP-02, Tiger 2000

Key features – Electrics



Valve terminals for standard applications
Fixed-grid

Pin allocation – Multi-pin connector plug - Valve/sensor terminal								
Connector view (top view)		1-12	13-24	25-36	37-48	49-60	61-72	Remarks
Multi-pin connector, 72-pin								
	1	00.00	00.12	01.08	10.00	10.12	11.08	10 to 16 valve positions 72 pin multi connector plug Connecting cable 50 x 0.75 mm ² (10) 65 x 0.75 mm ² (12/14) 80 x 0.75 mm ² (16)
	2	00.01	00.13	01.09	10.01	10.13	11.09	
	3	00.02	00.14	01.10	10.02	10.14	11.10	
	4	00.03	00.15	01.11	10.03	10.15	11.11	
	5	00.04	01.00	01.12	10.04	11.00	11.12	
	6	00.05	01.01	01.13	10.05	11.01	11.13	
	7	00.06	01.02	01.14	10.06	11.02	11.14	
	8	00.07	01.03	01.15	10.07	11.013.0	11.15	
	9	00.08	01.04	02.00	10.08	11.04	12.00	
	10	00.09	01.05	02.01	10.09	11.05	12.01	
	11	00.10	01.06	¹⁾	10.10	11.06	24 V	
	12	00.11	01.07	¹⁾	10.11	11.07	0 V	
Output (solenoid valve position)				Input				

1) Return line (output)
24 V, 0 V supply (input, protection T 3.15 A)

2.3

Valve terminal type 02 VIMP/IIMP-02, Tiger 2000

Technical data

-  - Flow rate up to
 G $\frac{3}{8}$: 750 l/min
 1,000 l/min
 G $\frac{1}{4}$: 1,300 l/min
 1600 l/min

-  - Valve width
 G $\frac{3}{8}$ 26 mm
 G $\frac{1}{4}$ 32 mm

-  - Voltage
 24 V DC



General technical data		
Valve terminal	Connection size G $\frac{3}{8}$	Connection size G $\frac{1}{4}$
Design	Poppet valve (5/2-way valves MVH and MVH-S), all others piston spool valves	
Width [mm]	26	32
Lubrication	<ul style="list-style-type: none"> • Poppet valve: Lubricated for life, PWIS free (free of paint wetting impairment substances) • Piston spool valve: Lubricated for life, PWIS critical (critical for paint wetting impairment substances) 	
Type of mounting	Through-holes on manifold	
Fitting position	Any	
Manual override	Non-detenting, detenting	
Pneumatic connections		
Supply connection	1 G $\frac{3}{8}$	G $\frac{1}{2}$
Exhaust connection	3/5 G $\frac{3}{8}$	G $\frac{1}{2}$
Working lines	2/4 G $\frac{1}{8}$	G $\frac{1}{4}$
Pilot air connection	12/14 G $\frac{1}{8}$	G $\frac{1}{8}$
Pilot exhaust air connection	82/84 G $\frac{1}{8}$	G $\frac{1}{8}$

Nominal size [mm]								
Valves	MVH	MVH-S	MVH-L	MVH-L-S	JMVH	JMVH-S	MVH-5/3	MVH-5/3-S
Connection size G $\frac{3}{8}$	5		8					
Connection size G $\frac{1}{4}$	7		10					

Operating pressure [bar]								
Valves	MVH	MVH-S	MVH-L	MVH-L-S	JMVH	JMVH-S	MVH-5/3	MVH-5/3-S
	2 ... 10	0 ... 10	3 ... 10	-0.9 ... +10	2 ... 10	-0.9 ... +10	3 ... 10	-0.9 ... +10

Pilot pressure [bar]								
Valves	MVH	MVH-S	MVH-L	MVH-L-S	JMVH	JMVH-S	MVH-5/3	MVH-5/3-S
Connection size G $\frac{3}{8}$	-	2 ... 10	-	3 ... 10	-	2 ... 10	-	3 ... 10
Connection size G $\frac{1}{4}$	-	1.5 ... 10	-	3 ... 10	-	2 ... 10	-	3 ... 10

Valve terminal type 02 VIMP/IIMP-02, Tiger 2000

FESTO

Technical data

Valve response times [ms]									
Valves		MVH	MVH-S	MVH-L	MVH-L-S	JMVH	JMVH-S	MVH-5/3	MVH-5/3-S
Response times (G ^{1/8})	On	20	20	31	31	–	–	30	30
	Off	36	36	18	18	–	–	26	26
	Change-over	–	–	–	–	18	18	–	–
Response times (G ^{1/4})	On	15	15	28	28	–	–	32	32
	Off	36	36	37	37	–	–	28	28
	Change-over	–	–	–	–	16	16	–	–

Operating and environmental conditions									
Valves		MVH	MVH-S	MVH-L	MVH-L-S	JMVH	JMVH-S	MVH-5/3	MVH-5/3-S
Operating medium		filtered compressed air, lubricated or unlubricated							
Grade of filtration	[µm]	40							
Ambient temperature	[°C]	–5 ... +50							

Electrical data									
Valves		MVH	MVH-S	MVH-L	MVH-L-S	JMVH	JMVH-S	MVH-5/3	MVH-5/3-S
Electromagnetic compatibility of the valve terminal		Interference emission tested to EN 61 000-6-4, "Interference emission in industry" Interference immunity tested to EN 61 000-6-2, "Interference immunity in industry"							
Protection against electric shock (protection against direct and indirect contact to EN 60204-1/IEC 204)		Through PELV power supply unit							
Operating voltage	[V]	24 DC (±10%)							
Residual ripple	[V _{SS}]	4							
Electrical power consumption per valve solenoid	[W]	2.9							
Duty cycle		100%							
Protection class to EN 60 529		IP65 (when fitted)							
Sensor inputs and auxiliary inputs		0 ... 30 V DC, positive logic (PNP), ON: 12.5 V, OFF: 7 V Delay time: typ. 5 ms, current consumption typ. 9 mA							
Additional outputs		24 V DC, 0.5 A, positive logic (PNP) Short circuit proof, tripping current max. 1 A, response time max. 1 ms							
Vibration resistance		Tested to DIN/IEC 68/EN 60 068, Parts 2-6 0.35 mm at 10 ... 58 Hz, 5 g at 60 ... 150 Hz							
Resistance to shocks		Tested to DIN/IEC 68/EN 60 068, Parts 2-27 +/- 30 g at 11 ms, 15 cycles							
Endurance resistance to shock		Tested to DIN/IEC 68/EN 60 068, Parts 2-29 +/- 15 g at 6 ms, 1000 cycles							

Valve terminal type 02 VIMP/IIMP-02, Tiger 2000

FESTO

Technical data

Electrical data, relay plate		
Relay plate IRP1-02-.../IRP2-02-...	NO contact	Relay is controlled like a valve
• Max. switching voltage	250 V AC/125 V AC	
• Max. switching/carrier current	2 A	
• Min. permissible load	5 V DC, 10 mA	
• Permissible electrical load	Resistive load ($\cos\varphi = 1$, $L/R = 0$ ms)	Inductive load ($\cos\varphi = 0.4$, $L/R = 7$ ms)
• Nominal load	250 V AC, 2 A 30 V DC, 2 A	250 V AC, 1 A 30 V DC, 1 A
• Max. switching capacity	500 VA, 60 W	250 VA, 30 W

Materials								
Valves	MVH	MVH-S	MVH-L	MVH-L-S	JMVH	JMVH-S	MVH-5/3	MVH-5/3-S
Housing, cover	Die-cast aluminium							
Seals	PU, nitrile rubber (NBR)							

Nominal flow rate [l/min]								
Valves	MVH	MVH-S	MVH-L	MVH-L-S	JMVH	JMVH-S	MVH-5/3	MVH-5/3-S
Connection size G $\frac{1}{8}$	750		1000					
Connection size G $\frac{1}{4}$	1300		1600					

Valve terminal type 02 VIMP/IIMP-02, Tiger 2000

Technical data



Dimensions

Download CAD data → www.festo.com/en/engineering

without inputs

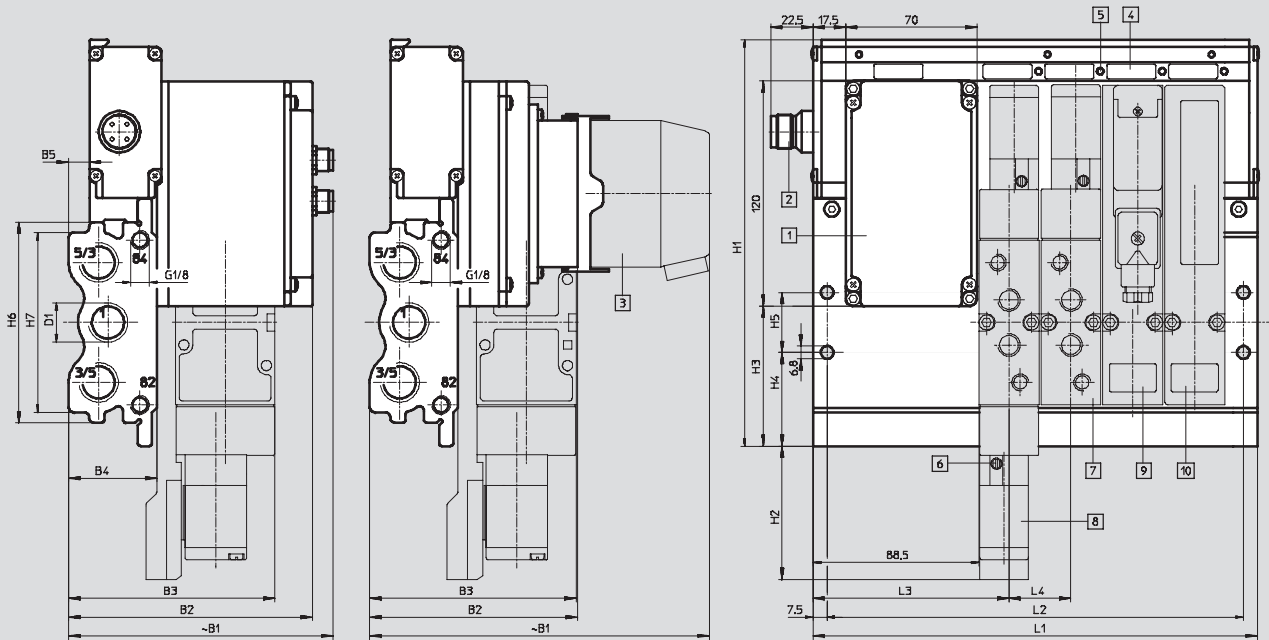

- | | | | |
|---|--|----------------------------|--|
| 1 Fieldbus nodes, control block or multi-connection nodes | 3 Multi-pin connector plug socket for VIMP | 6 Manual override, pushing | 8 Double solenoid valve or 5/3-way valve |
| 2 Power supply for VIFB, VISB | 4 Inscription field | 7 Solenoid valve | 9 Relay plate |
| | 5 LED display, yellow | | 10 Blanking plate |

Valve terminals for standard applications
Fixed-grid

2.3

Valve terminal type 02 VIMP/IIMP-02, Tiger 2000



Technical data

Type	B1~	B2	B3	B4	B5	D1	H1	H2	H3	H4	H5	H6	H7	L1	L2	L3	L4	L5
VIFB-02-1/8-4	140	128.8	102.5	45.5	8.4	G3/8	205	70.5	62.6	46.2	27.5	95	75	213	198	101.5	27	5
VIMP-02-1/8-4	180	109.2																
VIFB-02-1/8-6	140	128.5												267	252			
VIMP-02-1/8-6	180	109.2																
VIFB-02-1/8-8	140	128.5												321	306			
VIMP-02-1/8-8	180	109.2																
VIFB-02-1/8-10	140	128.5												375	360			
VIMP-02-1/8-10	180	109.2																
VIFB-02-1/8-12	140	128.5												429	414			
VIMP-02-1/8-12	180	109.2																
VIFB-02-1/8-14	140	128.5												483	468			
VIMP-02-1/8-14	180	109.2																
VIFB-02-1/8-16	140	128.5												537	522			
VIMP-02-1/8-16	180	109.2																
VIFB-02-1/4-4	141	130	110	47	11.1	G1/2	217	71	75	50	32	107	96	237	222	104.5	33	6
VIMP-02-1/4-4	182	110.7																
VIFB-02-1/4-6	141	130												303	288			
VIMP-02-1/4-6	182	110.7																
VIFB-02-1/4-8	141	130												369	354			
VIMP-02-1/4-8	182	110.7																
VIFB-02-1/4-10	141	130												435	420			
VIMP-02-1/4-10	182	110.7																
VIFB-02-1/4-12	141	130												501	486			
VIMP-02-1/4-12	182	110.7																
VIFB-02-1/4-14	141	130												567	552			
VIMP-02-1/4-14	182	110.7																
VIFB-02-1/4-16	141	130												633	618			
VIMP-02-1/4-16	182	110.7																

Valve terminals for standard applications
Fixed-grid

2.3

Valve terminal type 02 VIMP/IIMP-02, Tiger 2000

Technical data



Dimensions

Download CAD data → www.festo.com/en/engineering

With inputs

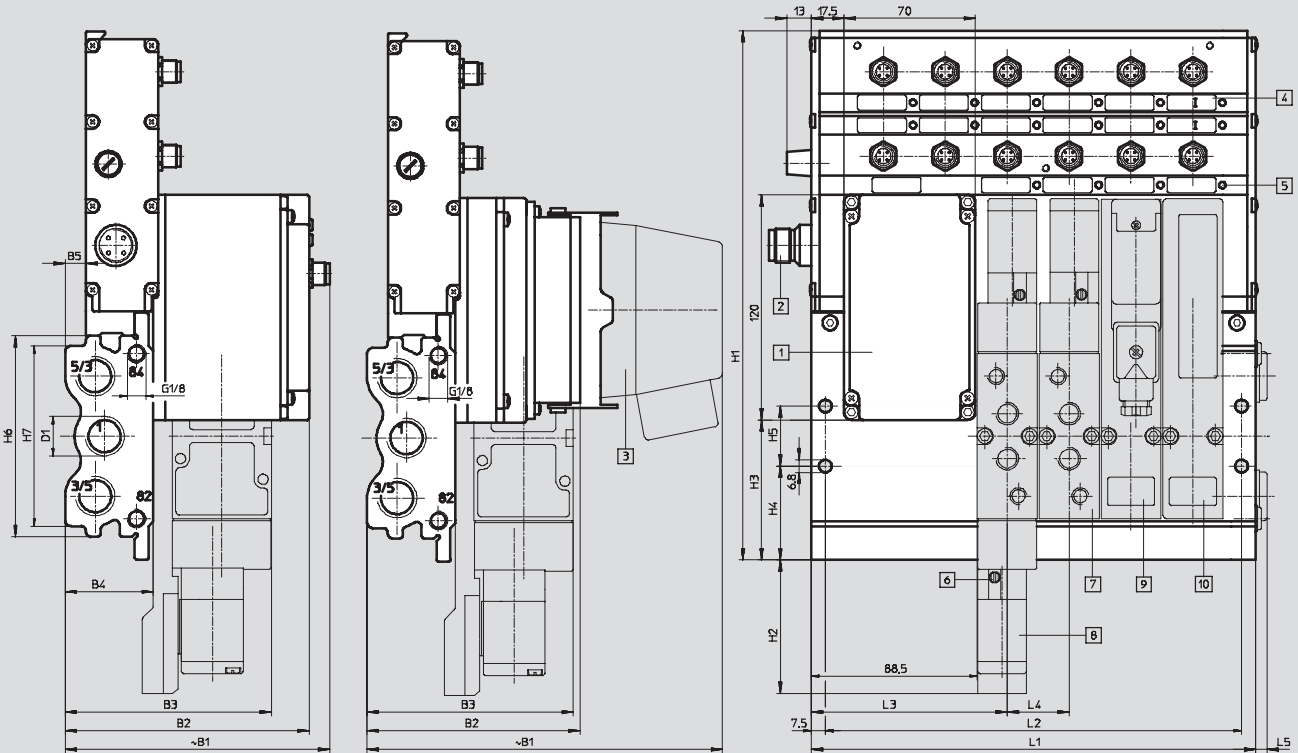

- | | | | |
|---|--|----------------------------|--|
| 1 Fieldbus nodes, control block or multi-connection nodes | 3 Multi-pin connector plug socket for IIMP | 6 Manual override, pushing | 8 Double solenoid valve or 5/3-way valve |
| 2 Power supply for IIFB, IISB | 4 Inscription field | 7 Solenoid valve | 9 Relay plate |
| | 5 LED display, yellow | | 10 Blanking plate |

Valve terminals for standard applications
Fixed-grid

2.3

Valve terminal type 02 VIMP/IIMP-02, Tiger 2000



Technical data

Type	B1~	B2	B3	B4	B5	D1	H1	H2	H3	H4	H5	H6	H7	L1	L2	L3	L4	L5
IIFB-02-1/8-4	140	128.8	102.5	45.5	8.4	G3/8	270.5	70.5	62.6	46.2	27.5	95	75	213	198	101.5	27	5
IIMP-02-1/8-4	188	112																
IIFB-02-1/8-6	140	128.5												267	252			
IIMP-02-1/8-6	188	112																
IIFB-02-1/8-8	140	128.5												321	306			
IIMP-02-1/8-8	188	112																
IIFB-02-1/8-10	140	128.5												375	360			
IIMP-02-1/8-10	188	112																
IIFB-02-1/8-12	140	128.5												429	414			
IIMP-02-1/8-12	188	112																
IIFB-02-1/8-14	140	128.5												483	468			
IIMP-02-1/8-14	188	112																
IIFB-02-1/8-16	140	128.5												537	522			
IIMP-02-1/8-16	188	112																
IIFB-02-1/4-4	141	130	110	47	11.1	G1/2	282.5	71	75	50	32	107	96	237	222	104.5	33	6
IIMP-02-1/4-4	190	113.5																
IIFB-02-1/4-6	141	130												303	288			
IIMP-02-1/4-6	190	113.5																
IIFB-02-1/4-8	141	130												369	354			
IIMP-02-1/4-8	190	113.5																
IIFB-02-1/4-10	141	130												435	420			
IIMP-02-1/4-10	190	113.5																
IIFB-02-1/4-12	141	130												501	486			
IIMP-02-1/4-12	190	113.5																
IIFB-02-1/4-14	141	130												567	552			
IIMP-02-1/4-14	190	113.5																
IIFB-02-1/4-16 ¹⁾	141	130												633	618			
IIMP-02-1/4-16	190	113.5																

1) 16 valve positions are not possible for the fieldbus connection, but are possible for control block SB-.....

Valve terminal type 02 VIMP/IIMP-02, Tiger 2000

Ordering information



Ordering system information

Basic entry			
<p>You can order a valve terminal type 02 via an order code (also called ident. code).</p> <p>First, choose between a basic valve terminal (without sensor inputs) or a valve/sensor terminal with sensor inputs (VI or II).</p> <p>Then select the required connection types on the valve terminal nodes (MP, FB or SB).</p> <p>Select the required valve connection size (G$\frac{1}{8}$ or G$\frac{1}{4}$)</p> <p>This information provides you with the precise basic data for the order code of the valve terminal, i. e.:</p> <ul style="list-style-type: none"> • VIMP-02-$\frac{1}{8}$-... • VIFB-02-$\frac{1}{4}$-... • IIFB-02-$\frac{1}{4}$-... • IISB-02-$\frac{1}{4}$-... 	<p>Then determine how many valve positions you need.</p> <ul style="list-style-type: none"> • A valve terminal type 02 consists of at least 4 valve positions and can be expanded two by two. Vacant positions may also be included to allow for expansion at a later point in time, which can be closed off with inexpensive blanking plates. 	<p>Select the nodes you want to equip your valve terminal with. There are various types available, in particular for fieldbuses and control blocks.</p> <p>With this data, the order code for the example expands as follows:</p> <ul style="list-style-type: none"> • VIMP-02-$\frac{1}{8}$-6-MP1-... • VIFB-02-$\frac{1}{4}$-10-FB6-... • IIFB-02-$\frac{1}{4}$-16-SF3-... • IISB-02-$\frac{1}{4}$-... 	<p>Decide which valve (relay/blanking plate) should be assembled on which valve position.</p> <p>Note that each valve terminal can be fitted with up to 16 valve positions, however a valve/sensor terminal with sensor inputs combined with a fieldbus connection only has 14 valve positions.</p> <p>Enter the code letters accordingly.</p>
Accessories			
<p>These code letters are followed by entries for any required accessories such as</p> <ul style="list-style-type: none"> • Separating plugs for two separate pressure zones • Plugs for sensors • Special DUO cable for two sensors on one plug • Sockets for operating voltage connection, fieldbus connection, control block programming interface or auxiliary outputs. <p>Complete order examples:</p> <p>VIMP-02-$\frac{1}{8}$-6-MP1-JJMMMA-C</p> <p>VIFB-02-$\frac{1}{4}$-FB6-10-JJMMMAQQQ-CMB</p> <p>IIFB-02-$\frac{1}{4}$-16-SF3-JJJMMMMMMMQQQ-M4S16J</p>	<p>Please ensure:</p> <p>That you order the correct plug accessories for the fieldbus connections and for the control blocks.</p> <p>The following applies to accessories: Several identical components can be grouped and ordered by using a prefixed number, i.e. "4S" instead of "SSSS".</p>	<p>Each valve terminal is generally supplied with a comprehensive, user-friendly manual.</p> <p>If you already have the relevant manuals, you can specify this in the order code (add code "B").</p> <p>It is also possible to order additionally required manuals, even in other languages if required. Other languages on request.</p>	<p>Individual parts can be ordered via their part numbers for retrofitting and expansion independent of the order code. Use the depicted overview list in addition to the explanations for the ident. code order.</p>

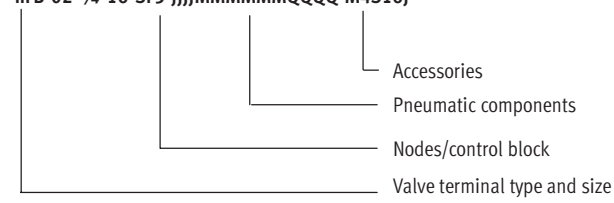

Valve terminal type 02 VIMP-02, Tiger 2000, G¹/₈ – Multi-pin plug



Ordering data – Modular product system

M Mandatory data →

Module No.	Valve terminal type 02	Size	Connection sizes	Number of valve positions	Electrical connection
18 386	VIMP	02	1/8	16	MP1
18 385				14	
18 384				12	
18 565				10	
18 564				8	
18 563				6	
18 562	4				
Ordering example					
18 565	VIMP	- 02	- 1/8	- 10	- MP1
1	2	3	4	5	6

Ordering table

									Condi- tions	Code	Enter code		
M	1	Module No.	18 386	18 385	18 384	18 565	18 564	18 563	18 562				
	2	Valve terminal	Valve terminal type 02									VIMP	VIMP
	3	Size	Size 02									-02	-02
	4	Connection sizes	Connection G ¹ / ₈									-1/8	-1/8
	5	Number of valve positions	16	14	12	10	8	6	4		-...		
↓	6	Electrical connection	Multi-pin plug									-MP1	-MP1

Valve terminals for standard applications
Fixed-grid

2.3

Transfer order code

	VIMP	-	02	-	1/8	-		-	MP1
1	2		3		4		5		6

Valve terminal type 02 VIMP-02, Tiger 2000, G¹/₈ – Multi-pin plug

Ordering data – Modular product system



M Mandatory data

Equipping of valve terminal

M, V, L, P, J, K, G, B, E, O, C, F, A, R, Q

Valve positions

1 2 3 4 5 6 7 8 9 10 11 12 13 14 15 16

- M B E M M V L F Q A + D W

7

O Options

Accessories Pneumatic

D, H

Accessories Electrical

Y, W

8

Ordering table

Module No.	18 386	18 385	18 384	18 565	18 564	18 563	18 562	Condi- tions	Code	Enter code
↓ M 7	Equipping of valve terminal							-	-	-
	5/2-way valve, single solenoid								M	Enter equip- ment selection for valve positions in order code
	5/2-way valve, single solenoid, auxiliary pilot air								V	
	5/2-way valve, single solenoid, pneumatic spring								L	
	5/2-way valve, single solenoid, pneumatic spring, auxiliary pilot air								P	
	5/2-way double-solenoid valve								J	
	5/2-way valve, double solenoid, auxiliary pilot air								K	
	5/3-way valve, mid-position closed								G	
	5/3-way valve, mid-position pressurised								B	
	5/3-way valve, mid-position exhausted								E	
	5/3-way valve, mid-position closed, auxiliary pilot air								O	
	5/3-way valve, mid-position pressurised, auxiliary pilot air								C	
	5/3-way valve, mid-position exhausted, auxiliary pilot air								F	
	Blanking plate for vacant position								A	
	Relay plate x1								R	
Relay plate x2								Q		
O 8	Accessories								+	+
	Pneumatic accessories									
	Sealing plug 1 position								D	
	Sealing plug 2 positions								H	
Electrical accessories										
Multi-pin plug socket (contacts 1.5 mm ²)								Y		
Multi-pin plug socket (contacts 0.75 mm ²)								W		

Transfer order code

1 2 3 4 5 6 7 8 9 10 11 12 13 14 15 16

- [] [] [] [] [] [] [] [] [] [] [] [] [] [] [] [] + [] [] [] [] [] [] [] []

7

8

Valve terminal type 02 VIMP-02, Tiger 2000, G¹/₄ – Multi-pin plug

Ordering data – Modular product system

M Mandatory data →

Module No.	Valve terminal type 02	Size	Connection sizes	Number of valve positions	Electrical connection
18 389	VIMP	02	1/4	16	MP1
18 388				14	
18 387				12	
18 569				10	
18 568				8	
18 567				6	
18 566	4				
Ordering example					
18 567	VIMP	- 02	- 1/4	- 6	- MP1
1	2	3	4	5	6

Ordering table

									Condi- tions	Code	Enter code		
M	1	Module No.	18 389	18 388	18 387	18 569	18 568	18 567	18 566				
	2	Valve terminal	Valve terminal type 02									VIMP	VIMP
	3	Size	Size 02									-02	-02
	4	Connection sizes	G ¹ / ₄ connections									-1/4	-1/4
	5	Number of valve positions	16	14	12	10	8	6	4		-...		
	6	Electrical connection	Multi-pin plug									-MP1	-MP1

Valve terminals for standard applications
Fixed-grid

Transfer order code

	VIMP	-	02	-	1/4	-		-	MP1
1	2		3		4		5		6

Valve terminal type 02 VIMP-02, Tiger 2000, G¹/₄ – Multi-pin plug

Ordering data – Modular product system



M Mandatory data

Equipping of valve terminal

M, V, L, P, J, K, G, B, E, O, C, F, A, R, Q

Valve positions

1	2	3	4	5	6	7	8	9	10	11	12	13	14	15	16
-	M	M	M	B	O	A									
7															

O Options

Accessories Pneumatic	Accessories Electrical
D, H	Y, W
+	
H	W
8	

Ordering table

Module No.		18 389	18 388	18 387	18 569	18 568	18 567	18 566	Condi- tions	Code	Enter code
M 7	Equipping of valve terminal								-	-	-
	5/2-way valve, single solenoid									M	Enter equip- ment selection for valve positions in order code
	5/2-way valve, single solenoid, auxiliary pilot air									V	
	5/2-way valve, single solenoid, pneumatic spring									L	
	5/2-way valve, single solenoid, pneumatic spring, auxiliary pilot air									P	
	5/2-way double-solenoid valve									J	
	5/2-way valve, double solenoid, auxiliary pilot air									K	
	5/3-way valve, mid-position closed									G	
	5/3-way valve, mid-position pressurised									B	
	5/3-way valve, mid-position exhausted									E	
	5/3-way valve, mid-position closed, auxiliary pilot air									O	
	5/3-way valve, mid-position pressurised, auxiliary pilot air									C	
	5/3-way valve, mid-position exhausted, auxiliary pilot air									F	
	Blanking plate for vacant position									A	
	Relay plate x1									R	
Relay plate x2									Q		
O 8	Accessories									+	+
	Pneumatic accessories	Sealing plug 1 position								D	
		Sealing plug 2 positions								H	
	Electrical accessories	Multi-pin plug socket (contacts 1.5 mm ²)								Y	
Multi-pin plug socket (contacts 0.75 mm ²)								W			

Transfer order code

1	2	3	4	5	6	7	8	9	10	11	12	13	14	15	16		
-																	
7																	
															+		
															8		

Valve terminal type 02 VIFB-02, Tiger 2000, G¹/₈ – Fieldbus



Ordering data – Modular product system

M Mandatory data →

Module No.	Valve terminal type 02	Size	Connection sizes	Number of valve positions	Electrical connection
18 376	VIFB	02	1/8	16	FB5
18 381				14	FB6
18 380				12	FB8
18 553				10	F11
18 552				8	F13
18 551				6	
18 550	4				
Ordering example					
18 552	VIFB	- 02	- 1/8	- 8	- F13
1	2	3	4	5	6

Ordering table

									Condi- tions	Code	Enter code	
M	1	Module No.	18 376	18 381	18 380	18 553	18 552	18 551	18 550			
	2	Valve terminal	Valve terminal type 02								VIFB	VIFB
	3	Size	Size 02								-02	-02
	4	Connection sizes	Connection G ¹ / ₈								-1/8	-1/8
	5	Number of valve positions	16	14	12	10	8	6	4	-...		
	6	Electrical connection	Festo FB, ABB (CS31), Moeller Suconet K								-FB5	
			Interbus								-FB6	
			Allen-Bradley (1771 RIO)								-FB8	
			DeviceNet								-F11	
			Profibus DP, 12 MBd								-F13	

Valve terminals for standard applications
Fixed-grid

2.3

Transfer order code

	VIFB	-	02	-	1/8	-		-	
1	2		3		4		5		6

Valve terminal type 02 VIFB-02, Tiger 2000, G1/8 – Fieldbus



Ordering data – Modular product system

M Mandatory data

Equipping of valve terminal

M, V, L, P, J, K, G, B, E, O, C, F, A, R, Q

Valve positions

1	2	3	4	5	6	7	8	9	10	11	12	13	14	15	16
-	B	B	E	O	M	M	M	R							

7

O Options

Accessories Pneumatic	Accessories Electrical	User documentation
D, H	N, M, I, 2Z, 2T, 2U, 2E, 2F, V	B
+ D H	+ 2Z	+ B

8

Ordering table

Module No.	18 376	18 381	18 380	18 553	18 552	18 551	18 550	Condi- tions	Code	Enter code	
↓ M 7 Equipping of valve terminal									-	-	
	5/2-way valve, single solenoid								M	Enter equip- ment selection for valve positions in order code	
	5/2-way valve, single solenoid, auxiliary pilot air								V		
	5/2-way valve, single solenoid, pneumatic spring								L		
	5/2-way valve, single solenoid, pneumatic spring, auxiliary pilot air								P		
	5/2-way double-solenoid valve								J		
	5/2-way valve, double solenoid, auxiliary pilot air								K		
	5/3-way valve, mid-position closed								G		
	5/3-way valve, mid-position pressurised								B		
	5/3-way valve, mid-position exhausted								E		
	5/3-way valve, mid-position closed, auxiliary pilot air								O		
	5/3-way valve, mid-position pressurised, auxiliary pilot air								C		
	5/3-way valve, mid-position exhausted, auxiliary pilot air								F		
	Blanking plate for vacant position								A		
	Relay plate x1								R		
Relay plate x2								Q			
O 8 Accessories									+	+	
	Pneumatic accessories	Sealing plug 1 position								D	
		Sealing plug 2 positions								H	
	Electrical accessories	Power supply socket, straight (for 1.5 mm ²)								N	
		Power supply socket, straight (for 2.5 mm ²)								M	
		Power supply socket, angled for (1.5 mm ²)								I	
		2 connection sockets, straight, Pg 7								2Z	
		2 connection sockets, angled, Pg 9								2T	
		2 connection sockets, angled, Pg 13.5								2U	
		2 connection sockets, angled, Pg 7								2E	
		2 connection sockets, angled, Pg 9								2F	
		Sub-D fieldbus connector for Profibus-DP								V	
	User documentation	Express waiver – no manual to be included								B	

Transfer order code

1	2	3	4	5	6	7	8	9	10	11	12	13	14	15	16
-															

7

+															
---	--	--	--	--	--	--	--	--	--	--	--	--	--	--	--

8

Valve terminal type 02 VIFB-02, Tiger 2000, G¹/₄ – Fieldbus



Ordering data – Modular product system

M Mandatory data →

Module No.	Valve terminal type 02	Size	Connection sizes	Number of valve positions	Electrical connection
18 377	VIFB	02	1/4	16	FB5
18 383				14	FB6
18 382				12	FB8
18 557				10	F11
18 556				8	F13
18 555				6	
18 554				4	
Ordering example					
18 377	VIFB	- 02	- 1/4	- 16	- FB8
1	2	3	4	5	6

Ordering table

								Condi- tions	Code	Enter code		
M	1	Module No.	18 377	18 383	18 382	18 557	18 556	18 555	18 554			
	2	Valve terminal	Valve terminal type 02								VIFB	VIFB
	3	Size	Size 02								-02	-02
	4	Connection sizes	G ¹ / ₄ connections								-1/4	-1/4
	5	Number of valve positions	16	14	12	10	8	6	4	-...		
	6	Electrical connection	Festo FB, ABB (CS31), Moeller Suconet K								-FB5	
			Interbus								-FB6	
			Allen-Bradley (1771 RIO)								-FB8	
			DeviceNet								-F11	
			Profibus DP, 12 MBd								-F13	

Valve terminals for standard applications
Fixed-grid

2.3

Transfer order code

	VIFB	-	02	-	1/4	-		-	
1	2		3		4		5		6

Valve terminal type 02 VIFB-02, Tiger 2000, G¹/₄ – Fieldbus



Ordering data – Modular product system

M Mandatory data

Equipping of valve terminal

M, V, L, P, J, K, G, B, E, O, C, F, A, R, Q

Valve positions

1	2	3	4	5	6	7	8	9	10	11	12	13	14	15	16
-	M	M	O	C	V	L	J	M	M	K	P	M	M	M	M

7

O Options

Accessories Pneumatic	Accessories Electrical	User documentation
D, H	N, M, I, 2Z, 2T, 2U, 2E, 2F, V	B
+ D H	+ 2U	

8

Ordering table

Module No.	18 377	18 383	18 382	18 557	18 556	18 555	18 554	Condi- tions	Code	Enter code
↓										
M 7	Equipping of valve terminal								-	-
	5/2-way valve, single solenoid								M	Enter equip- ment selection for valve positions in order code
	5/2-way valve, single solenoid, auxiliary pilot air								V	
	5/2-way valve, single solenoid, pneumatic spring								L	
	5/2-way valve, single solenoid, pneumatic spring, auxiliary pilot air								P	
	5/2-way double-solenoid valve								J	
	5/2-way valve, double solenoid, auxiliary pilot air								K	
	5/3-way valve, mid-position closed								G	
	5/3-way valve, mid-position pressurised								B	
	5/3-way valve, mid-position exhausted								E	
	5/3-way valve, mid-position closed, auxiliary pilot air								O	
	5/3-way valve, mid-position pressurised, auxiliary pilot air								C	
	5/3-way valve, mid-position exhausted, auxiliary pilot air								F	
	Blanking plate for vacant position								A	
	Relay plate x1								R	
	Relay plate x2								Q	
O 8	Accessories								+	+
	Pneumatic accessories									
	Sealing plug 1 position								D	
	Sealing plug 2 positions								H	
	Electrical accessories									
	Power supply socket, straight (for 1.5 mm ²)								N	
	Power supply socket, straight (for 2.5 mm ²)								M	
	Power supply socket, angled for (1.5 mm ²)								I	
	2 connection sockets, straight, Pg 7								2Z	
	2 connection sockets, angled, Pg 9								2T	
	2 connection sockets, angled, Pg 13.5								2U	
	2 connection sockets, angled, Pg 7								2E	
	2 connection sockets, angled, Pg 9								2F	
	Sub-D fieldbus connector for Profibus-DP								V	
	User documentation								B	
	Express waiver – no manual to be included									

Transfer order code

1 2 3 4 5 6 7 8 9 10 11 12 13 14 15 16

-															
---	--	--	--	--	--	--	--	--	--	--	--	--	--	--	--

7

+															
---	--	--	--	--	--	--	--	--	--	--	--	--	--	--	--

8

Valve terminal type 02 IIMP-02, Tiger 2000, G¹/₈ – Multi-pin plug



Ordering data – Modular product system

M Mandatory data →

Module No.	Valve terminal type 02	Size	Connection sizes	Number of valve positions	Electrical connection
18 870	IIMP	02	1/8	16	MP1
18 869				14	
18 868				12	
18 867				10	
18 866				8	
18 865				6	
18 864				4	
Ordering example					
18 864	IIMP	- 02	- 1/8	- 4	- MP1
1	2	3	4	5	6

Ordering table

									Condi- tions	Code	Enter code		
M	1	Module No.	18 870	18 869	18 868	18 867	18 866	18 865	18 864				
	2	Valve terminal	Valve terminal type 02									IIMP	IIMP
	3	Size	Size 02									-02	-02
	4	Connection sizes	Connection G ¹ / ₈									-1/8	-1/8
	5	Number of valve positions	16	14	12	10	8	6	4		-...		
↓	6	Electrical connection	Multi-pin plug									-MP1	-MP1

Valve terminals for standard applications
Fixed-grid

2.3

Transfer order code

	IIMP	-	02	-	1/8	-		-	MP1
1	2		3		4		5		6

Valve terminal type 02 IIMP-02, Tiger 2000, G¹/₈ – Multi-pin plug



Ordering data – Modular product system

M Mandatory data

Equipping of valve terminal

M, V, L, P, J, K, G, B, E, O, C, F, A, R, Q

Valve positions

1	2	3	4	5	6	7	8	9	10	11	12	13	14	15	16
-	M	M	M	M											
7															

O Options

Accessories Pneumatic	Accessories Electrical
D, H	Y, W, ...S, ...J, ...K, ...L, ...P, ...Q
+ H	5K
8	

Ordering table

Module No.	18 870	18 869	18 868	18 867	18 866	18 865	18 864	Condi- tions	Code	Enter code	
↓ M 7 Equipping of valve terminal									-	-	
	5/2-way valve, single solenoid								M	Enter equip- ment selection for valve positions in order code	
	5/2-way valve, single solenoid, auxiliary pilot air								V		
	5/2-way valve, single solenoid, pneumatic spring								L		
	5/2-way valve, single solenoid, pneumatic spring, auxiliary pilot air								P		
	5/2-way double-solenoid valve								J		
	5/2-way valve, double solenoid, auxiliary pilot air								K		
	5/3-way valve, mid-position closed								G		
	5/3-way valve, mid-position pressurised								B		
	5/3-way valve, mid-position exhausted								E		
	5/3-way valve, mid-position closed, auxiliary pilot air								O		
	5/3-way valve, mid-position pressurised, auxiliary pilot air								C		
	5/3-way valve, mid-position exhausted, auxiliary pilot air								F		
	Blanking plate for vacant position								A		
	Relay plate x1								R		
Relay plate x2								Q			
O 8 Accessories									+	+	
	Pneumatic accessories	Sealing plug 1 position								D	
		Sealing plug 2 positions								H	
	Electrical accessories	Multi-pin plug socket (contacts 1.5 mm ²)								Y	
		Multi-pin plug socket (contacts 0.75 mm ²)								W	
		Sensor plug straight, M12, Pg 7; 1 ... 99								...S	
		DUO cable, 2x straight socket; 1 ... 99								...J	
		DUO cable, 2x straight/angled socket; 1 ... 99								...K	
		DUO cable, 2x angled socket; 1 ... 99								...L	
		Extension cable, 4 pin, 2.5 m; 1 ... 99								...P	
Extension cable, 4 pin, 5 m; 1 ... 99								...Q			

Transfer order code

1	2	3	4	5	6	7	8	9	10	11	12	13	14	15	16			
-																		
7																		
																+		
																8		

Valve terminal type 02 IIMP-02, Tiger 2000, G¹/₄ – Multi-pin plug

Ordering data – Modular product system

M Mandatory data →

Module No.	Valve terminal type 02	Size	Connection sizes	Number of valve positions	Electrical connection
18 877	IIMP	02	1/4	16	MP1
18 876				14	
18 875				12	
18 874				10	
18 873				8	
18 872				6	
18 871				4	
Ordering example					
18 876	IIMP	- 02	- 1/4	- 14	- MP1
1	2	3	4	5	6

Ordering table

									Condi- tions	Code	Enter code		
M	1	Module No.	18 877	18 876	18 875	18 874	18 873	18 872	18 871				
	2	Valve terminal	Valve terminal type 02									IIMP	IIMP
	3	Size	Size 02									-02	-02
	4	Connection sizes	G ¹ / ₄ connections									-1/4	-1/4
	5	Number of valve positions	16	14	12	10	8	6	4		-...		
↓	6	Electrical connection	Multi-pin plug									-MP1	

Valve terminals for standard applications
Fixed-grid

Transfer order code

	IIMP	-	02	-	1/4	-		-	MP1
1	2		3		4		5		6

Valve terminal type 02 IIMP-02, Tiger 2000, G $\frac{1}{4}$ – Multi-pin plug

Ordering data – Modular product system

M Mandatory data

Equipping of valve terminal

M, V, L, P, J, K, G, B, E, O, C, F, A, R, Q

Valve positions

1	2	3	4	5	6	7	8	9	10	11	12	13	14	15	16	
-	L	L	M	M	B	B	M	E	E	E	M	M	O	G		
7															+	

O Options

Accessories Pneumatic	Accessories Electrical
D, H	Y, W, ...S, ...J, ...K, ...L, ...P, ...Q
+	
H	W
8	

Ordering table

Module No.	18 877	18 876	18 875	18 874	18 873	18 872	18 871	Condi-tions	Code	Enter code
M 7	Equipping of valve terminal							-	-	-
	5/2-way valve, single solenoid								M	Enter equip-ment selection for valve positions in order code
	5/2-way valve, single solenoid, auxiliary pilot air								V	
	5/2-way valve, single solenoid, pneumatic spring								L	
	5/2-way valve, single solenoid, pneumatic spring, auxiliary pilot air								P	
	5/2-way double-solenoid valve								J	
	5/2-way valve, double solenoid, auxiliary pilot air								K	
	5/3-way valve, mid-position closed								G	
	5/3-way valve, mid-position pressurised								B	
	5/3-way valve, mid-position exhausted								E	
	5/3-way valve, mid-position closed, auxiliary pilot air								O	
	5/3-way valve, mid-position pressurised, auxiliary pilot air								C	
	5/3-way valve, mid-position exhausted, auxiliary pilot air								F	
	Blanking plate for vacant position								A	
	Relay plate x1								R	
Relay plate x2								Q		
O 8	Accessories								+	+
	Pneumatic accessories									
	Sealing plug 1 position								D	
	Sealing plug 2 positions								H	
	Electrical accessories									
	Multi-pin plug socket (contacts 1.5 mm ²)								Y	
	Multi-pin plug socket (contacts 0.75 mm ²)								W	
	Sensor plug straight, M12, Pg 7; 1 ... 99								...S	
	DUO cable, 2x straight socket; 1 ... 99								...J	
	DUO cable, 2x straight/angled socket; 1 ... 99								...K	
DUO cable, 2x angled socket; 1 ... 99								...L		
Extension cable, 4 pin, 2.5 m; 1 ... 99								...P		
Extension cable, 4 pin, 5 m; 1 ... 99								...Q		

Transfer order code

1	2	3	4	5	6	7	8	9	10	11	12	13	14	15	16			
-																		
7															+			

Valve terminal type 02 IIFB-02, Tiger 2000, G¹/₈ – Fieldbus



Ordering data – Modular product system

M Mandatory data →

Module No.	Valve terminal type 02	Size	Connection sizes	Number of valve positions	Electrical connection
18 855	IIFB	02	1/8	14	FB5
18 854				12	FB6
18 853				10	FB8
18 852				8	F11
18 851				6	F13
18 850				4	
Ordering example					
18 850	IIFB	- 02	- 1/8	- 4	- FB5
1	2	3	4	5	6

Ordering table

								Condi- tions	Code	Enter code	
M	1	Module No.	18 855	18 854	18 853	18 852	18 851	18 850			
	2	Valve terminal	Valve terminal type 02							IIFB	IIFB
	3	Size	Size 02							-02	-02
	4	Connection sizes	Connection G ¹ / ₈							-1/8	-1/8
	5	Number of valve positions	14	12	10	8	6	4	-...		
	6	Electrical connection	Festo FB, ABB (CS31), Moeller Suconet K							-FB5	
			Interbus							-FB6	
			Allen-Bradley (1771 RIO)							-FB8	
			DeviceNet							-F11	
			Profibus DP, 12 MBd							-F13	

Valve terminals for standard applications
Fixed-grid

2.3

Transfer order code

	IIFB	-	02	-	1/8	-		-	
1	2		3		4		5		6

Valve terminal type 02 IIFB-02, Tiger 2000, G^{1/8} – Fieldbus



Ordering data – Modular product system

M Mandatory data →

Equipping of valve terminal

M, V, L, P, J, K, G, B, E, O, C, F, A, R, Q

Valve positions

1	2	3	4	5	6	7	8	9	10	11	12	13	14
- G	B	E	O										

7

Ordering table

Module No.	18 855	18 854	18 853	18 852	18 851	18 850	Condi- tions	Code	Enter code
↓									
M 7	Equipping of valve terminal							-	-
	5/2-way valve, single solenoid							M	Enter equip- ment selection for valve positions in order code
	5/2-way valve, single solenoid, auxiliary pilot air							V	
	5/2-way valve, single solenoid, pneumatic spring							L	
	5/2-way valve, single solenoid, pneumatic spring, auxiliary pilot air							P	
	5/2-way double-solenoid valve							J	
	5/2-way valve, double solenoid, auxiliary pilot air							K	
	5/3-way valve, mid-position closed							G	
	5/3-way valve, mid-position pressurised							B	
	5/3-way valve, mid-position exhausted							E	
	5/3-way valve, mid-position closed, auxiliary pilot air							O	
	5/3-way valve, mid-position pressurised, auxiliary pilot air							C	
	5/3-way valve, mid-position exhausted, auxiliary pilot air							F	
	Blanking plate for vacant position							A	
	Relay plate x1							R	
↓	Relay plate x2							Q	

Transfer order code

1	2	3	4	5	6	7	8	9	10	11	12	13	14
-													

7

Valve terminal type 02 IIFB-02, Tiger 2000, G¹/₈ – Fieldbus



Ordering data – Modular product system

Options

Accessories	Accessories	User documentation
Pneumatic	Electrical	
D, H	N, M, I, ...S, ...J, ...K, ...L, ...P, ...Q, 2Z, 2T, 2U, 2E, 2F, V	B
+ D	6L	
8		

Ordering table

Module No.	18 855	18 854	18 853	18 852	18 851	18 850	Condi- tions	Code	Enter code
0								+	+
8	Accessories							D	
	Pneumatic accessories							H	
8	Electrical accessories							N	
								M	
								I	
								...S	
								...J	
								...K	
								...L	
								...P	
								...Q	
								2Z	
								2T	
								2U	
								2E	
								2F	
								V	
	User documentation							B	

Valve terminals for standard applications
Fixed-grid
2.3

Transfer order code

+			
8			

Valve terminal type 02 IIFB-02, Tiger 2000, G¹/₄ – Fieldbus



Ordering data – Modular product system

Valve terminals for standard applications
Fixed-grid

2.3

M Mandatory data →

Module No.	Valve terminal type 02	Size	Connection sizes	Number of valve positions	Electrical connection
18 862	IIFB	02	1/4	14	FB5
18 861				12	FB6
18 860				10	FB8
18 859				8	F11
18 858				6	F13
18 857				4	
Ordering example					
18 860	IIFB	- 02	- 1/4	- 10	- FB6
1	2	3	4	5	6

Ordering table

							Condi- tions	Code	Enter code	
M	1	Module No.	18 862	18 861	18 860	18 859	18 858	18 857		
	2	Valve terminal	Valve terminal type 02						IIFB	IIFB
	3	Size	Size 02						-02	-02
	4	Connection sizes	G ¹ / ₄ connections						-1/4	-1/4
	5	Number of valve positions	14	12	10	8	6	4	-...	
	6	Electrical connection	Festo FB, ABB (CS31), Moeller Suconet K						-FB5	
			Interbus						-FB6	
			Allen-Bradley (1771 RIO)						-FB8	
			DeviceNet						-F11	
			Profibus DP, 12 MBd						-F13	

Transfer order code

	IIFB	-	02	-	1/4	-		-	
1	2		3		4		5		6

Valve terminal type 02 IIFB-02, Tiger 2000, G¹/₄ – Fieldbus



Ordering data – Modular product system

M Mandatory data													
Equipping of valve terminal													
M, V, L, P, J, K, G, B, E, O, C, F, A, R, Q													
Valve positions													
1	2	3	4	5	6	7	8	9	10	11	12	13	14
M	V	P	B	O	M	M	G	B	Q				
7													

Ordering table										
Module No.	18 862	18 861	18 860	18 859	18 858	18 857	Condi- tions	Code	Enter code	
7	Equipping of valve terminal							-	-	
	5/2-way valve, single solenoid							M	Enter equip- ment selection for valve positions in order code	
	5/2-way valve, single solenoid, auxiliary pilot air							V		
	5/2-way valve, single solenoid, pneumatic spring							L		
	5/2-way valve, single solenoid, pneumatic spring, auxiliary pilot air							P		
	5/2-way double-solenoid valve							J		
	5/2-way valve, double solenoid, auxiliary pilot air							K		
	5/3-way valve, mid-position closed							G		
	5/3-way valve, mid-position pressurised							B		
	5/3-way valve, mid-position exhausted							E		
	5/3-way valve, mid-position closed, auxiliary pilot air							O		
	5/3-way valve, mid-position pressurised, auxiliary pilot air							C		
	5/3-way valve, mid-position exhausted, auxiliary pilot air							F		
	Blanking plate for vacant position							A		
	Relay plate x1							R		
	Relay plate x2							Q		

Transfer order code													
1	2	3	4	5	6	7	8	9	10	11	12	13	14
7													

Valve terminal type 02 IIFB-02, Tiger 2000, G¹/₄ – Fieldbus



Ordering data – Modular product system

Options

Accessories Pneumatic	Accessories Electrical	User documentation
D, H	N, M, I, S, ...J, ...K, ...L, ...P, ...Q, 2Z, 2T, 2U, 2E, 2F, V	B
+ D H	6L 2T	

8

Ordering table

Module No.	18 862	18 861	18 860	18 859	18 858	18 857	Condi- tions	Code	Enter code
0	Accessories							+	+
8	Pneumatic accessories							D	
	Sealing plug 1 position							H	
8	Electrical accessories							N	
	Power supply socket, straight (for 1.5 mm ²)							M	
	Power supply socket, straight (for 2.5 mm ²)							I	
	Power supply socket, angled for (1.5 mm ²)							S	
	Sensor plug straight, M12, Pg 7							...J	
	DUO cable, 2x straight socket; 1 ... 99							...K	
	DUO cable, 2x straight/angled socket; 1 ... 99							...L	
	DUO cable, 2x angled socket; 1 ... 99							...P	
	Extension cable, 4 pin, 2.5 m; 1 ... 99							...Q	
	Extension cable, 4 pin, 5 m; 1 ... 99							2Z	
	2 connection sockets, straight, Pg 7							2T	
	2 connection sockets, angled, Pg 9							2U	
	2 connection sockets, angled, Pg 13.5							2E	
	2 connection sockets, angled, Pg 7							2F	
	2 connection sockets, angled, Pg 9							V	
	Sub-D fieldbus connector for Profibus-DP							B	
	User documentation								
	Express waiver – no manual to be included								

Transfer order code

+			
----------	--	--	--

8

Valve terminal type 02 IIFB-02, Tiger 2000, G¹/₈ – Control block SF3



Ordering data – Modular product system

M Mandatory data →

Module No.	Valve terminal type 02	Size	Connection sizes	Number of valve positions	Electrical connection
18 856	IIFB	02	1/8	16	SF3
18 855				14	
18 854				12	
18 853				10	
18 852				8	
18 851				6	
18 850				4	
Ordering example					
18 850	IIFB	- 02	- 1/8	- 4	- SF3
1	2	3	4	5	6

Ordering table

									Condi- tions	Code	Enter code		
M	1	Module No.	18 856	18 855	18 854	18 853	18 852	18 851	18 850				
	2	Valve terminal	Valve terminal type 02									IIFB	IIFB
	3	Size	Size 02									-02	-02
	4	Connection sizes	Connection G ¹ / ₈									-1/8	-1/8
	5	Number of valve positions	16	14	12	10	8	6	4		-...		
↓	6	Electrical connection	Control block SF3 with Festo fieldbus									- SF3	

Valve terminals for standard applications
Fixed-grid

2.3

Transfer order code

1	2	3	4	5	6
	IIFB	- 02	- 1/8		

Valve terminal type 02 IIFB-02, Tiger 2000, G^{1/8} – Control block SF3



Ordering data – Modular product system

M Mandatory data →

Equipping of valve terminal

M, V, L, P, J, K, G, B, E, O, C, F, A, R, Q

Valve positions

	1	2	3	4	5	6	7	8	9	10	11	12	13	14	15	16
-	G	B	E	O												

7

Ordering table

Module No.	18 856	18 855	18 854	18 853	18 852	18 851	18 850	Condi- tions	Code	Enter code			
↓	Equipping of valve terminal											-	-
M 7	5/2-way valve, single solenoid											M	Enter equip- ment selection for valve positions in order code
	5/2-way valve, single solenoid, auxiliary pilot air											V	
	5/2-way valve, single solenoid, pneumatic spring											L	
	5/2-way valve, single solenoid, pneumatic spring, auxiliary pilot air											P	
	5/2-way double-solenoid valve											J	
	5/2-way valve, double solenoid, auxiliary pilot air											K	
	5/3-way valve, mid-position closed											G	
	5/3-way valve, mid-position pressurised											B	
	5/3-way valve, mid-position exhausted											E	
	5/3-way valve, mid-position closed, auxiliary pilot air											O	
	5/3-way valve, mid-position pressurised, auxiliary pilot air											C	
	5/3-way valve, mid-position exhausted, auxiliary pilot air											F	
	Blanking plate for vacant position											A	
	Relay plate x1											R	
↓	Relay plate x2											Q	

Transfer order code

	1	2	3	4	5	6	7	8	9	10	11	12	13	14	15	16
-																

7

Valve terminal type 02 IIFB-02, Tiger 2000, G¹/₈ – Control block SF3



Ordering data – Modular product system

Options

Accessories Pneumatic	Accessories Electrical	User documentation
D, H	N, M, I, ...S, ...J, ...K, ...L, ...P, ...Q, 2Z, 2T, 2U, 2E, 2F	B
+ D	4L	B

8

Ordering table

Module No.	18 856	18 855	18 854	18 853	18 852	18 851	18 850	Condi- tions	Code	Enter code
0	Accessories								+	+
8	Pneumatic accessories								D	
	Sealing plug 1 position								H	
8	Electrical accessories								N	
	Power supply socket, straight (for 1.5 mm ²)								M	
	Power supply socket, straight (for 2.5 mm ²)								I	
	Power supply socket, angled for (1.5 mm ²)								...S	
	Sensor plug straight, M12, Pg 7; 1 ... 99								...J	
	DUO cable, 2x straight socket; 1 ... 99								...K	
	DUO cable, 2x straight/angled socket; 1 ... 99								...L	
	DUO cable, 2x angled socket; 1 ... 99								...P	
	Extension cable, 4 pin, 2.5 m; 1 ... 99								...Q	
	Extension cable, 4 pin, 5 m; 1 ... 99								2Z	
	2 connection sockets, straight, Pg 7								2T	
	2 connection sockets, angled, Pg 9								2U	
	2 connection sockets, angled, Pg 13.5								2E	
	2 connection sockets, angled, Pg 7								2F	
2 connection sockets, angled, Pg 9								B		
User documentation										
Express waiver – no manual to be included										

Valve terminals for standard applications
Fixed-grid

2.3

Transfer order code

+			
----------	--	--	--

8

Valve terminal type 02 IIFB-02, Tiger 2000, G¹/₄ – Control block SF3



Ordering data – Modular product system

Valve terminals for standard applications
Fixed-grid

2.3

M Mandatory data →

Module No.	Valve terminal type 02	Size	Connection sizes	Number of valve positions	Electrical connection
18 863	IIFB	02	1/4	16	SF3
18 862				14	
18 861				12	
18 860				10	
18 859				8	
18 858				6	
18 857				4	
Ordering example					
18 860	IIFB	- 02	- 1/4	- 10	- SF3
1	2	3	4	5	6

Ordering table

									Condi- tions	Code	Enter code		
M	1	Module No.	18 863	18 862	18 861	18 860	18 859	18 858	18 857				
	2	Valve terminal	Valve terminal type 02									IIFB	IIFB
	3	Size	Size 02									-02	-02
	4	Connection sizes	G ¹ / ₄ connections									-1/4	-1/4
	5	Number of valve positions	16	14	12	10	8	6	4		-...		
	6	Electrical connection	Control block SF3 with Festo fieldbus									- SF3	

Transfer order code

1	IIFB	-	02	-	1/4	-		-	
---	------	---	----	---	-----	---	--	---	--

Valve terminal type 02 IIFB-02, Tiger 2000, G¹/₄ – Control block SF3



Ordering data – Modular product system

M Mandatory data →

Equipping of valve terminal

M, V, L, P, J, K, G, B, E, O, C, F, A, R, Q

Valve positions

1	2	3	4	5	6	7	8	9	10	11	12	13	14	15	16
M	V	P	B	O	M	M	G	B	Q						

7

Ordering table

Module No.	18 863	18 862	18 861	18 860	18 859	18 858	18 857	Condi- tions	Code	Enter code
↓ M 7 ↓	Equipping of valve terminal								-	-
	5/2-way valve, single solenoid								M	Enter equip- ment selection for valve positions in order code
	5/2-way valve, single solenoid, auxiliary pilot air								V	
	5/2-way valve, single solenoid, pneumatic spring								L	
	5/2-way valve, single solenoid, pneumatic spring, auxiliary pilot air								P	
	5/2-way double-solenoid valve								J	
	5/2-way valve, double solenoid, auxiliary pilot air								K	
	5/3-way valve, mid-position closed								G	
	5/3-way valve, mid-position pressurised								B	
	5/3-way valve, mid-position exhausted								E	
	5/3-way valve, mid-position closed, auxiliary pilot air								O	
	5/3-way valve, mid-position pressurised, auxiliary pilot air								C	
	5/3-way valve, mid-position exhausted, auxiliary pilot air								F	
	Blanking plate for vacant position								A	
	Relay plate x1								R	
Relay plate x2								Q		

Valve terminals for standard applications
Fixed-grid
2.3

Transfer order code

1	2	3	4	5	6	7	8	9	10	11	12	13	14	15	16

7

Valve terminal type 02 IIFB-02, Tiger 2000, G¹/₄ – Control block SF3



Ordering data – Modular product system

Options

Accessories Pneumatic	Accessories Electrical	User documentation
D, H	N, M, I, ...S, ...J, ...K, ...L, ...P, ...Q, 2Z, 2T, 2U, 2E, 2F	B
+ D H	4L 2T	B

8

Ordering table											
Module No.		18 863	18 862	18 861	18 860	18 859	18 858	18 857	Condi- tions	Code	Enter code
0	Accessories									+	+
8	Pneumatic accessories	Sealing plug 1 position								D	
		Sealing plug 2 positions								H	
	Electrical accessories	Power supply socket, straight (for 1.5 mm ²)								N	
		Power supply socket, straight (for 2.5 mm ²)								M	
		Power supply socket, angled for (1.5 mm ²)								I	
		Sensor plug straight, M12, Pg 7; 1 ... 99								...S	
		DUO cable, 2x straight socket; 1 ... 99								...J	
		DUO cable, 2x straight/angled socket; 1 ... 99								...K	
		DUO cable, 2x angled socket; 1 ... 99								...L	
		Extension cable, 4 pin, 2.5 m; 1 ... 99								...P	
		Extension cable, 4 pin, 5 m; 1 ... 99								...Q	
		2 connection sockets, straight, Pg 7								2Z	
		2 connection sockets, angled, Pg 9								2T	
		2 connection sockets, angled, Pg 13.5								2U	
		2 connection sockets, angled, Pg 7								2E	
	2 connection sockets, angled, Pg 9								2F		
		User documentation	Express waiver – no manual to be included								B

Transfer order code





+			
----------	--	--	--

8

Valve terminal type 02 VIMP/IIMP, Tiger 2000

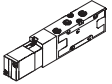
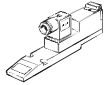
Ordering data – Accessories

FESTO

Ordering data					
	Code	Description	Connection	Type	Part No.
Valves					
	M	5/2-way solenoid valve	G $\frac{1}{8}$	MVH-5- $\frac{1}{8}$ -B-VI-X	164 564
			G $\frac{1}{4}$	MVH-5- $\frac{1}{4}$ -B-VI-X	164 566
	V	5/2-way solenoid valve with auxiliary pilot air	G $\frac{1}{8}$	MVH-5- $\frac{1}{8}$ -S-B-VI	116 001
			G $\frac{1}{4}$	MVH-5- $\frac{1}{4}$ -S-B-VI	116 003
	L	5/2-way solenoid valve with pneumatic spring	G $\frac{1}{8}$	MVH-5- $\frac{1}{8}$ -L-B-VI	117 424
			G $\frac{1}{4}$	MVH-5- $\frac{1}{4}$ -L-B-VI	117 428
	P	5/2-way solenoid valve with pneumatic spring and auxiliary pilot air	G $\frac{1}{8}$	MVH-5- $\frac{1}{8}$ -L-S-B-VI	117 426
			G $\frac{1}{4}$	MVH-5- $\frac{1}{4}$ -L-S-B-VI	117 430
	J	5/2-way double solenoid valve	G $\frac{1}{8}$	JMVH-5- $\frac{1}{8}$ -B-VI-X	164 565
			G $\frac{1}{4}$	JMVH-5- $\frac{1}{4}$ -B-VI-X	164 567
	K	5/2-way double solenoid valve with auxiliary pilot air	G $\frac{1}{8}$	JMVH-5- $\frac{1}{8}$ -S-B-VI	116 005
			G $\frac{1}{4}$	JMVH-5- $\frac{1}{4}$ -S-B-VI	116 007
	G	5/3-way solenoid valve Mid-position closed	G $\frac{1}{8}$	MVH-5/3G- $\frac{1}{8}$ -B-VI-X	164 568
			G $\frac{1}{4}$	MVH-5/3G- $\frac{1}{4}$ -B-VI-X	164 571
	O	5/3-way solenoid valve Mid-position closed with auxiliary pilot air	G $\frac{1}{8}$	MVH-5/3G- $\frac{1}{8}$ -S-B-VI	118 800
			G $\frac{1}{4}$	MVH-5/3G- $\frac{1}{4}$ -S-B-VI	118 806
	E	5/3-way solenoid valve Mid-position exhausted	G $\frac{1}{8}$	MVH-5/3E- $\frac{1}{8}$ -B-VI-X	164 570
			G $\frac{1}{4}$	MVH-5/3E- $\frac{1}{4}$ -B-VI-X	164 573
F	5/3-way solenoid valve Mid-position exhausted with auxiliary pilot air	G $\frac{1}{8}$	MVH-5/3E- $\frac{1}{8}$ -S-B-VI	118 804	
		G $\frac{1}{4}$	MVH-5/3E- $\frac{1}{4}$ -S-B-VI	118 810	
B	5/3-way solenoid valve Mid-position pressurised	G $\frac{1}{8}$	MVH-5/3B- $\frac{1}{8}$ -B-VI-X	164 569	
		G $\frac{1}{4}$	MVH-5/3B- $\frac{1}{4}$ -B-VI-X	164 572	
C	5/3-way solenoid valve Mid-position pressurised with auxiliary pilot air	G $\frac{1}{8}$	MVH-5/3B- $\frac{1}{8}$ -S-B-VI	118 802	
		G $\frac{1}{4}$	MVH-5/3B- $\frac{1}{4}$ -S-B-VI	118 808	
Accessories - General					
	R	Relay plate, x1	G $\frac{1}{8}$	IRP1-02- $\frac{1}{8}$	158 476
			G $\frac{1}{4}$	IRP1-02- $\frac{1}{4}$	158 477
	Q	Relay plate, x2	G $\frac{1}{8}$	IRP2-02- $\frac{1}{8}$	152 838
			G $\frac{1}{4}$	IRP2-02- $\frac{1}{4}$	152 839
	A	Blanking plate	G $\frac{1}{8}$	IAP-02- $\frac{1}{8}$	18 067
			G $\frac{1}{4}$	IAP-02- $\frac{1}{4}$	18 068
		Inscription label holder for I/O modules, type 02		IBT-02-E/A	158 968
		Inscription labels (pack of 20)		IBS-9x20	18 182
Pneumatic accessories					
	D	Sealing plug	G $\frac{1}{8}$	PRSV- $\frac{1}{8}$	160 997
			G $\frac{1}{4}$	PRSV- $\frac{1}{4}$	160 996

Valve terminals for standard applications
Fixed-grid

2.3









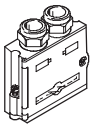

Valve terminal type 02 VIMP/IIMP, Tiger 2000

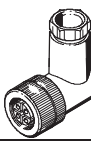
Ordering data – Accessories

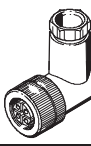

Valve terminals for standard applications
Fixed-grid

2.3

Ordering data					
	Code	Description	Connection	Type	Part No.
Fieldbus connection					
	V	Plug, sub-D connection	9-pin	FBS-Sub-9-GS-DP-B	532 216
		Bus connection, M12 adapter plug, Reversekey ProfiBus DP	2x5-pin, M12	FBA-2-M12-5POL-RK	533 118
	Z	Socket, fieldbus, straight, Pg7	4-pin, M12	FBSD-GD-7	18 497
	T	Socket, fieldbus, straight, Pg9	4-pin, M12	FBSD-GD-9	18 495
	U	Socket, fieldbus, straight, Pg13.5	4-pin, M12	FBSD-GD-13,5	18 496
	E	Socket, fieldbus, angled, Pg7	4-pin, M12	FBSD-WD-7	18 524
	F	Socket, fieldbus, angled, Pg9	4-pin, M12	FBSD-WD-9	18 525
		T adapter	4-pin, M12	FB-TA	18 498
			4-pin, M12	FB-TA-1	18 499
			5-pin, M12, DeviceNet	FB-TA-M12-5POL	171 175
		Plug pin adapter	4-pin, M12	SIE-GA	18780
Power supply					
	N	Power supply socket, straight, for 1.5 mm ² , Pg9	4-pin, M18	NTSD-GD-9	18 493
	M	Power supply socket, straight, for 2.5 mm ² , Pg13.5	4-pin, M18	NTSD-GD-13,5	18 526
	I	Power supply socket, angled, for 1.5 mm ² , Pg9	4-pin, M18	NTSD-WD-9	18 527
		Power supply socket, angled, for 2.5 mm ² , Pg11	4-pin, M18	NTSD-WD-11	533 119
Sensor connection					
	S	Plug, for inputs/outputs, straight, Pg7	4-pin, M12	SEA-GS-7	18 666
	J	DUO cable, 2xstraight socket	4-pin, M12, 2xM8	KM12-DUO-M8-GDGD	18 685
	K	DUO cable, straight/angled sockets	4-pin, M12, 2xM8	KM12-DUO-M8-GDWD	18 688
	L	DUO cable, 2xangled socket	4-pin, M12, 2xM8	KM12-DUO-M8-WDWD	18 687
	P	Connection cable, straight plug / straight socket, 2.5 m	4-pin, M12	KM12-M12-GSGD-2,5	18 684
	Q	Connection cable, straight plug / straight socket, 5.0 m	4-pin, M12	KM12-M12-GSGD-5	18 686

Valve terminal type 02 VIMP/IIMP, Tiger 2000

Ordering data – Accessories

FESTO

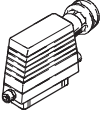
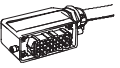
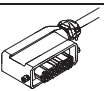
Ordering data					
	Code	Description	Connection	Type	Part No.
Cables and plugs					
	Y	Multi-pin plug socket (contacts 1.5 mm ²)	25-pin	IMP1-SD-25	18 317
			40-pin	IMP1-SD-40	18 318
			72-pin	IMP1-SD-72	18 319
	W	Multi-pin plug socket (contacts 0.75 mm ²)	25-pin	IMP1-SD-25-0,75	18 321
			40-pin	IMP1-SD-40-0,75	18 322
			72-pin	IMP1-SD-72-0,75	18 323
		Prefabricated cable with plug socket, 5 m	4...6 valves	KMP1-02-VI-6-5	175 585
			8...12 valves	KMP1-02-VI-12-5	175 587
			14...16 valves	KMP1-02-VI-16-5	175 589
		Prefabricated cable with plug socket, 10 m	4...6 valves	KMP1-02-VI-6-10	175 586
			8...12 valves	KMP1-02-VI-12-10	175 588
			14...16 valves	KMP1-02-VI-16-10	175 590
		Prefabricated cable with plug socket, for valve/sensor terminal, 5 m	4 valves/inputs	KMP1-02-II-4-5	175 654
			8 valves/inputs	KMP1-02-II-8-5	175 656
			10 valves/inputs	KMP1-02-II-10-5	175 658
			14 valves/inputs	KMP1-02-II-14-5	175 660
			16 valves/inputs	KMP1-02-II-16-5	175 662
		Prefabricated cable with plug socket, for valve/sensor terminal, 10 m	4 valves/inputs	KMP1-02-II-4-10	175 655
			8 valves/inputs	KMP1-02-II-8-10	175 657
			10 valves/inputs	KMP1-02-II-10-10	175 659
			14 valves/inputs	KMP1-02-II-14-10	175 661
			16 valves/inputs	KMP1-02-II-16-10	175 663



Valve terminals for standard applications
Fixed-grid

2.3

Valve terminal type 02 VIMP/IIMP, Tiger 2000

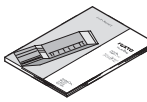

Ordering data – Accessories

Ordering data						
	Description	Valve terminal	Language	Type	Part No.	
User documentation						
	User documentation for type 02 valve terminals	FB5	German	P.BE-VIFB5-02-DE	18 417	
			English	P.BE-VIFB5-02-EN	18 483	
		FB6	German	P.BE-VIFB6-02-DE	18 418	
			English	P.BE-VIFB6-02-EN	18 484	
		FB8	German	P.BE-VIFB8-02-DE	151 762	
			English	P.BE-VIFB8-02-EN	151 763	
		FB11	German	P.BE-VIFB11-02-DE	164 585	
			English	P.BE-VIFB11-02-EN	164 590	
		FB13	German	P.BE-VIFB13-02-DE	164 587	
			English	P.BE-VIFB13-02-EN	164 592	
		SF3	German	P.BE-VISF3-02-DE	165 480	
			English	P.BE-VISF3-02-EN	165 485	
		User documentation for programmable valve terminals	Programming software SF3	German	P.BE-FST200-AWL/KOP-DE	165 484
				English	P.BE-FST200-AWL/KOP-EN	165 489
Software						
	CD-ROM	Utilities		P.CD-VI-UTILITIES-2	533 500	