



- Soft Stop
- Electronic end-position cushioning
- Freely selectable intermediate positions

# End position controllers SPC11

Key features



## Key features at a glance

Fast travel between two fixed stops with electronically controlled end position cushioning and up to two freely selectable intermediate positions.

- Up to 30% faster cycle rates
- Significantly reduced system vibration
- Fast problem-free commissioning, no specialists required
- Simple conversion of existing systems
- Optimum operating behaviour is maintained even with weight/load fluctuations of up to 30% of the total moving mass
- Less expensive than electromechanical drives
- Reduced noise level

## Individual components

### End position controller

Integrated functions:

- For determining system characteristic values of the connected components.
- Storage of the desired end positions or intermediate positions.

- Comparison of setpoint and actual position, and position control through appropriate actuation of the proportional 5/3-way valve (status control).
- Internal or external teach-in function.

SPC11



### Analogue displacement encoders

Analogue displacement encoder based on a conductive-plastic linear potentiometer. The system measures absolute values. It is connected alongside a pneumatic drive. Mounting kits are

available as accessories for the mechanical coupling. The displacement encoder is available in fixed stroke lengths ranging from 100 ... 2000 mm.

MLO-POT...-TLF



MLO-POT...-LWG



### Digital displacement encoders

Digital displacement encoders, magnetostrictive, contactless method of measurement. The system measures absolute values. It is connected alongside a pneumatic linear

drive. Mounting kits are available as accessories for the mechanical coupling. The displacement encoder is available in fixed stroke lengths ranging from 100 ... 2000 mm.

MME-MTS...-AIF



### Pneumatic drives

Pneumatic drives ensure an easy-to-operate system. The stroke length operating range depends on the selected drive. The range extends from 225 ... 2000 mm. The swivel angle with DSMI ranges from 0° ... 270°.

 Note  
The linear drives DGP/DGPL with compressed air supply connections at both ends (D2) should be used for effective cylinder strokes above 600 mm.

DGCI



DGPL, DGPLL



DNC



DNCI



DNCM



DSMI



### Proportional 5/3-way valves

Valve actuation is via the end position controller. The valve controls the volume of air supplied to the drive. The extremely short switching time of the valve makes the Smart Soft Stop solution package highly dynamic.

 Note  
Use a 5 µm filter for compressed air preparation. The compressed air supply must be un lubricated.

MPYE-5-...-010B

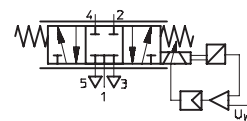

# End position controllers SPC11

Key features

**Possible combinations**  
with external displacement encoder

End position controller

Displacement encoder

Drive

SPC11  
with I/O interface  
→ 5 / 1.4-10



MLO-POT-...-TLF



MME-MTS-...-AIF



MLO-POT-...-LWG



DGP/DGPL



DNC



with external/integrated displacement encoder

End position controller

Drive with displacement encoder

SPC11  
with I/O interface  
→ 5 / 1.4-10



DGCI



DNCI



DGPI/DGPIL



DNCM



DSMI



# End position controllers SPC11

Key features



## Conventional solution

Previously you needed to

- Harmonise individual components.
- Install additional shock absorbers and possibly replace/exchange existing shock absorbers.
- Fit proximity sensors for position detection.
- Adjust the compressed air supply by means of flow control valves in order to optimise the system.

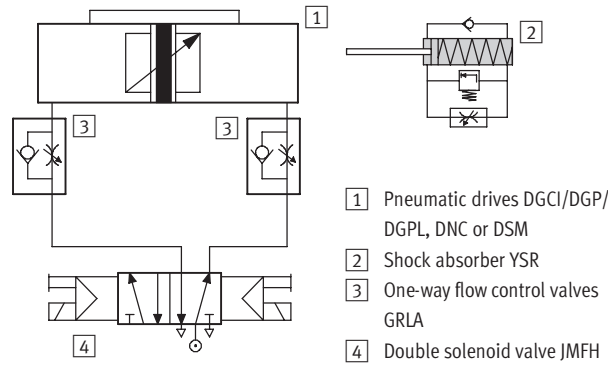

Until now, to create intermediate positions you had to

- Construct a complex mechanical solution using stopper cylinders, for example.
- Harmonise a large number of individual components.
- Perform extensive programming.

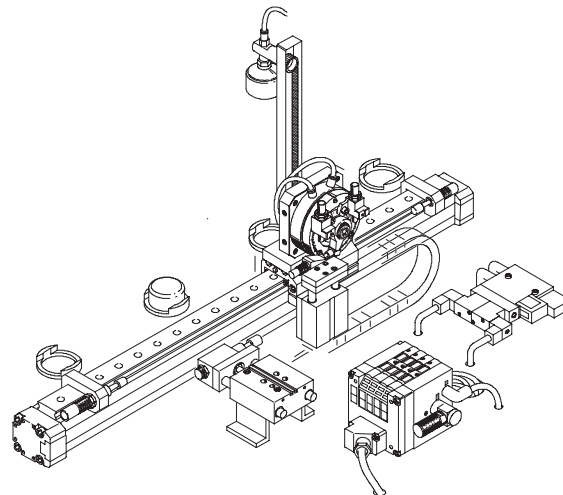

## Solution with end position controller SPC11

Fast travel between two fixed stops with up to two freely selectable intermediate positions

The Smart Soft Stop system with end position controller SPC11 facilitates travel between two fixed mechanical stops as well as travel to up to two freely selectable intermediate positions. The level of accuracy of the intermediate positions is  $\pm 0.25\%$  of the

displacement encoder length, and no less than  $\pm 2$  mm. The level of accuracy of the intermediate positions is  $\pm 2^\circ$  for the swivel module DSMI. Typical applications for the intermediate positions are rest or ejector positions, where a low-cost solution is more

important than achieving high levels of accuracy. The intermediate positions also have sensor functionality. This means that when the relevant intermediate position is passed, a 50 ms pulse is produced at the corresponding output.

# End position controllers SPC11

Key features

FESTO

## The Festo solution package

### Smart Soft Stop with end position controller SPC11

In an application with up to two intermediate positions you can now:

- Use the Festo solution package with a small number of harmonised components.
- Dispense with complex constructions using stopper cylinders.
- Approach the intermediate positions from both sides.
- Let optimisation be carried out by the learning system itself.

The Smart Soft Stop system with SPC11 has a remote input, which allows all three pushbuttons to be allocated to a master controller:

- All system parameters can be defined and changed externally.
- A signal at the remote input disables all pushbuttons on the end position controller SPC11.

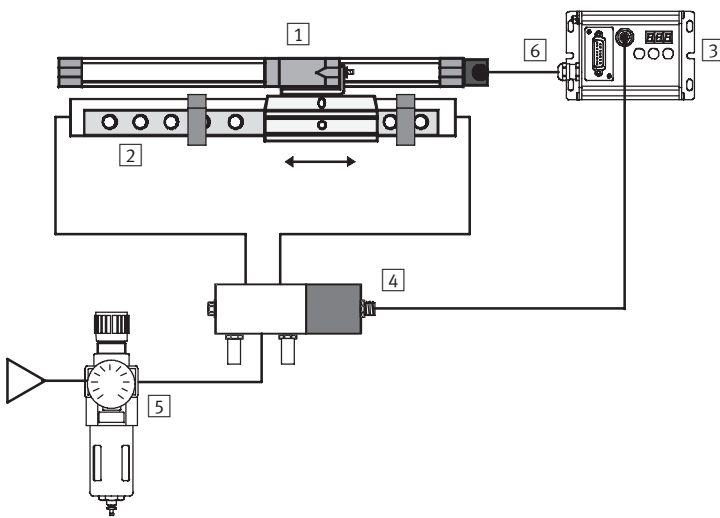

- |  |  |
|--|--|
| <p><b>1</b> Displacement encoder</p> <p>Digital:</p> <ul style="list-style-type: none"> <li>– MME-MTS-...-AIF</li> <li>– integrated in case of DGPI/DGPIL</li> </ul> <p>Analogue:</p> <ul style="list-style-type: none"> <li>– MLO-POT-...-TLF</li> <li>– MLO-POT-...-LWG</li> <li>– integrated in case of DSMI</li> </ul> | <p><b>3</b> End position controller</p> <ul style="list-style-type: none"> <li>SPC11-POT-TLF,</li> <li>SPC11-POT-LWG or</li> <li>SPC11-MTS-AIF</li> <li>SPC11-INC</li> </ul> <p><b>4</b> Proportional 5/3-way valve</p> <p>MPYE-5-...-010B</p> <p><b>5</b> Service unit (without lubricator, with 5 µm filter), supply pressure 5 to 7 bar</p> |
| <p><b>2</b> Pneumatic drives</p> <p>DGCI/DGP/DGPL, DGPI/DGPIL, DNC, DNCI, DNCM or DSMI</p>   | <p><b>6</b> Operating voltage connection and master controller</p>   |

# End position controllers SPC11

Key features



## The solution package

### Individual components

- Pneumatic drives  
DGCI/DGP/DGPL, DGPI/DGPIL, DNC, DNCI, DNCM or DSMI
- Proportional 5/3-way valve  
MPYE-5-...-010B
- Displacement encoder  
MLO-POT-...-TLF,  
MLO-POT-...-LWG or  
MME-MTS-...-AIF

- End position controller  
SPC11
- Valve cable  
KMPYE
- Controller cable  
KMPV-...
- Manual

Solution packages are uniquely defined, i.e. all components are harmonised for optimum performance. For details of this unique allocation please see → 5 / 1.4-19 or 5 / 1.4-39 or  
→ Smart Soft Stop software tool:  
[www.festo.com/en/engineering](http://www.festo.com/en/engineering)

Accessories available on separate order (fittings, tubing, etc.) can be found in the respective solution packages. An example of an order is shown on → 5 / 1.4-18 or 5 / 1.4-38.

PPV = Open the internal cushioning 100%

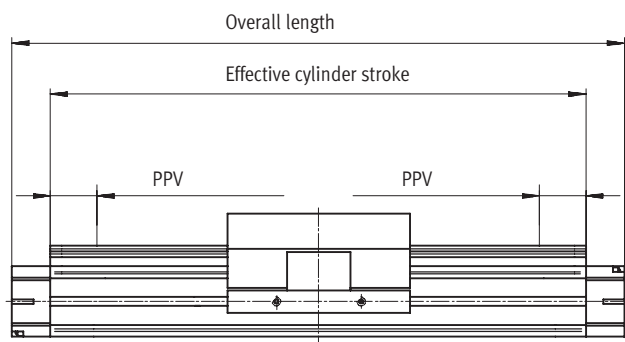

## Symmetrical

The desired travel distance should not therefore exceed the relevant effective cylinder stroke.

The following thus applies:

**travel distance ≤ effective cylinder stroke**

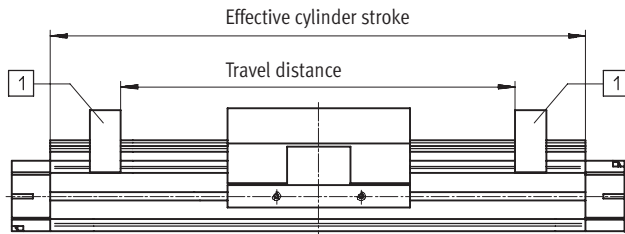

1 Fixed stops, mounted on drive or externally

## Asymmetrical

The desired travel distance within the effective cylinder stroke must be limited by means of fixed stops. The same applies to the pneumatic drives DGCI/DNC, DNCI, DNCM and DSMI.

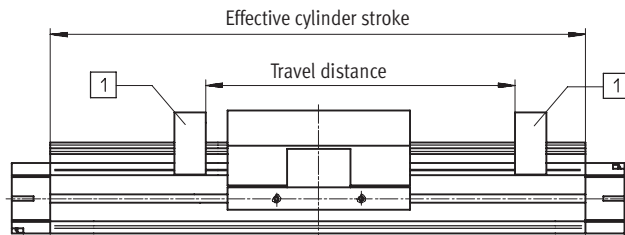

1 Fixed stops, mounted on drive or externally

- - Note

External limit stops are required in order to realise the effective stroke (or effective swivel angle in the case of DSMI) when using the pneumatic

drives DGCI, DNC, DNCI, DNCM und DSMI with the Smart Soft Stop system.

# End position controllers SPC11

Key features

## The solution package

- Advantages**
- Up to 30% faster cycle rates
  - Significantly reduced system vibration
  - Optimum operating behaviour is maintained even with weight/load fluctuations of up to 30% of the total moving mass
  - Simple conversion of existing systems
  - Considerably reduced noise level
  - Fast problem-free commissioning, no specialists required
  - Less expensive than electromechanical drives

The graphs apply to the following example:

- DGPL-25-1250-PPV-A-KF-B-GK-...-D2,
- Moving load: 12 kg
- Horizontal mounting position

**Note**  
The shape of the curve is identical for the pneumatic drives DGCI, DNC, DNCI, DNCM, DSMI and DGPI.

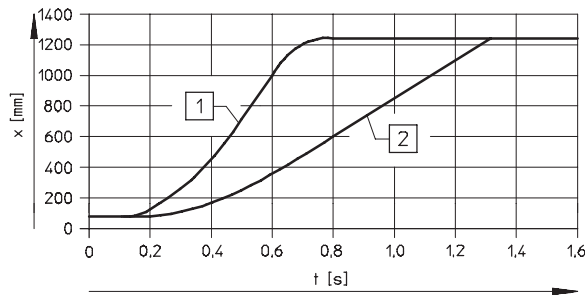

- 1 = Drive with electronic end position controller SPC11
- 2 = Drive with shock absorber

x = Travel distance  
t = Time

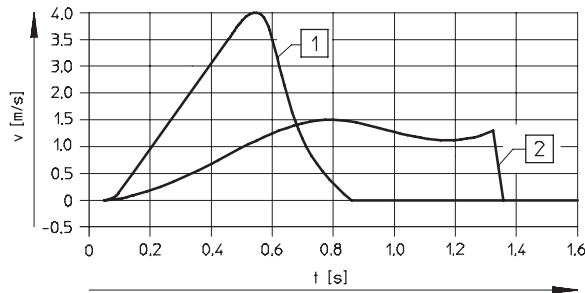

- 1 = Drive with electronic end position controller SPC11
- 2 = Drive with shock absorber

v = Velocity  
t = Time

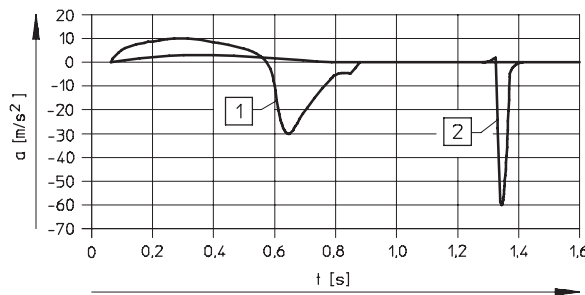

- 1 = Drive with electronic end position controller SPC11
- 2 = Drive with shock absorber

a = Acceleration  
t = Time

## Plug & work = Commissioning in just a few steps

- 1 Assemble the system components: Moving mass must be attached backlash-free.
- 2 Set up the pneumatic and electrical system connections.
- 3 Switch on the compressed air and supply voltage.
- 4 Start the teaching process by means of a button. The system learns autonomously and is ready for operation after 3 minutes.
- 5 Approach and save intermediate positions by means of buttons.

# End position controllers SPC11

Peripherals overview



## Variant with drive DGPIIL

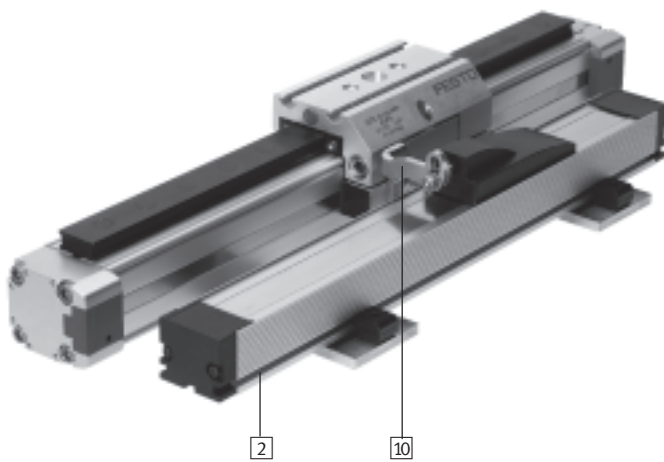
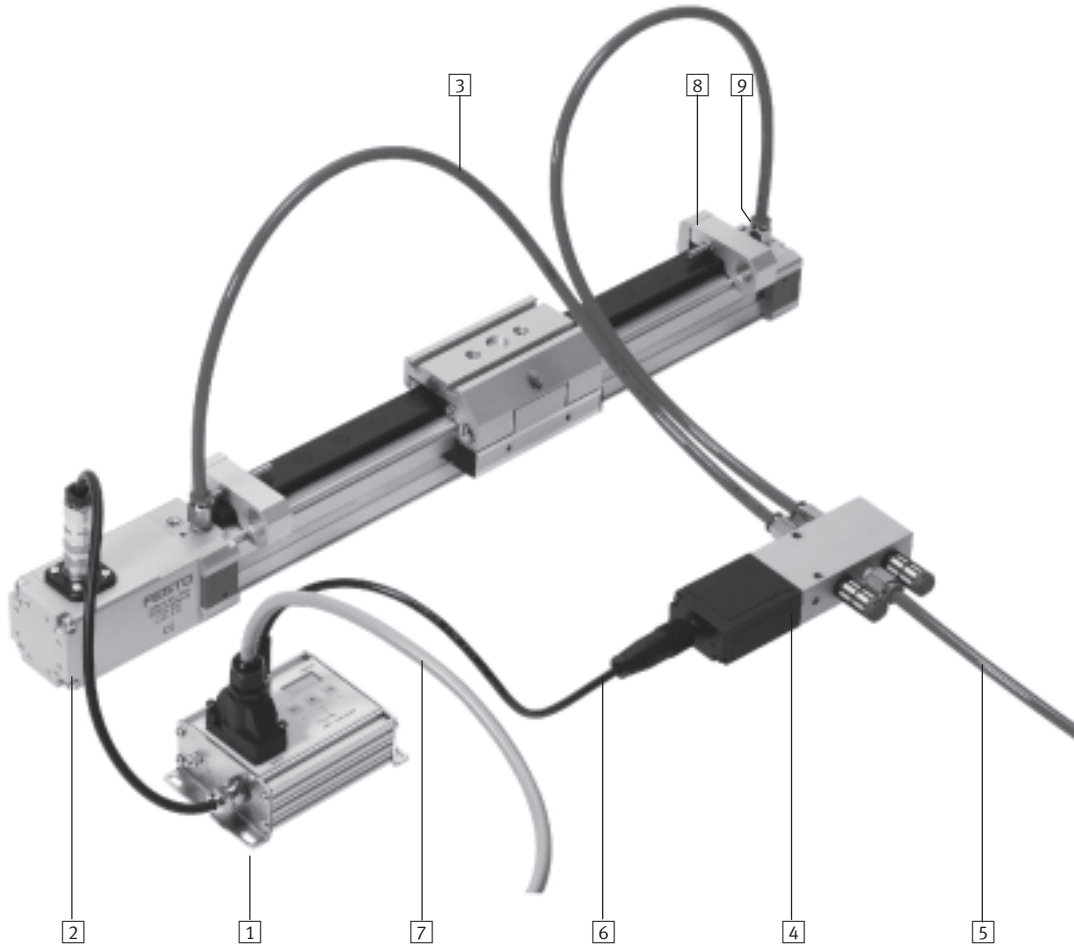

-  - Note

The same components are required for the drive DGPIIL as for the drive DGPIIL.

The integrated digital displacement encoder of the DGPIIL is replaced by an externally mounted displacement encoder (either digital or potentiometric).



## End position controllers SPC11

Peripherals overview

**FESTO**

Individual components							
Brief description	Pneumatic drives						
	DGCI	DGP/DGPL	DGPI/DGPIL	DNC	DNCI	DNCM	DSMI
1 End position controller SPC11	■	■	■	■	■	■	■
1 End position controller SPC11-ASI	-	■	■	■	-	■	■
2 Analogue displacement encoder MLO-POT-...-TLF	-	■	-	-	-	-	-
2 Analogue displacement encoder MLO-POT-...-LWG	-	-	-	■	-	-	-
2 Digital displacement encoder MME-MTS-...-AIF	-	■	-	-	-	-	-
3 Air supply lines (laid symmetrically)	■	■	■	■	■	■	■
4 Proportional 5/3-way valve MPYE	■	■	■	■	■	■	■
5 Compressed air supply	■	■	■	■	■	■	■
6 Connecting cable KMPYE to proportional 5/3-way valve	■	■	■	■	■	■	■
7 Connecting cable to controller	■	■	■	■	■	■	■
8 Fixed stop	■	■	■	1)	1)	1)	■
9 Push-in connector QS (preferably straight)	■	■	■	■	■	■	■
10 Displacement encoder mounting kit	-	■	-	-	-	-	-
Solution packages →	5 / 1.4-12	5 / 1.4-18	5 / 1.4-18	5 / 1.4-24	5 / 1.4-28	5 / 1.4-32	5 / 1.4-38

1) External limit stops are required with the DNC, DNCI and DNCM to limit the travel distance within the effective stroke.

Allocation of end position controller SPC11 to drive and displacement encoder					
End position controller	SPC11-POT-TLF SPC11-POT-TLF-ASI	SPC11-POT-LWG SPC11-POT-LWG-ASI	SPC11-MTS-AIF SPC11-MTS-AIF-ASI	SPC11-INC	SPC11-MTS-AIF-2
<b>Drive</b>					
DGCI	-	-	-	-	■
DGPI/DGPIL	-	-	■	-	-
DNCI	-	-	-	■	-
DNCM	■	-	-	-	-
DSMI	-	■	-	-	-
<b>Displacement encoder</b>					
MLO-POT-TLF	■	-	-	-	-
MLO-POT-LWG	-	■	-	-	-
MME-MTS-AIF	-	-	■	-	-

## End position controllers SPC11

Technical data

### Teach-in function

SPC11-POT-TLF  
SPC11-POT-LWG  
SPC11-MTS-AIF  
SPC11-INC  
SPC11-MTS-AIF-2

The teach-in travel (to determine the system data and end positions) can be started via a button on the end position controller SPC11 or via an external output which is connected through the control cable (e.g. the PLC).

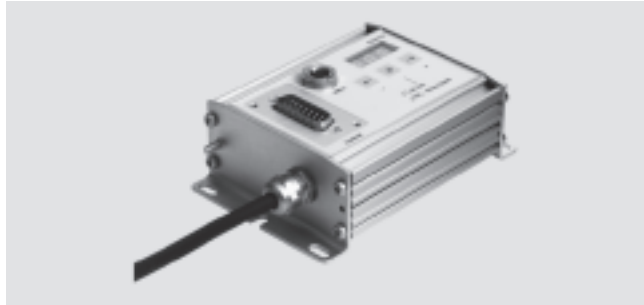

General technical data								
End position controller SPC11-...		Type	...-POT-TLF	...-POT-LWG	...-MTS-AIF	...-INC	...-MTS-AIF-2	
Operating voltage		[V DC]	24 (-25 ... +25%)					
Current consumption	with valve	[A]	1.3					1.1
	without valve	[mA]	70		170	80	70	
Residual ripple		[%]	Max. 5					
Digital inputs	Number		8					
	Input voltage	[V DC]	24					
	Input current	[mA]	4 (at 24 V DC)					
	Duty cycle	[ms]	min. 20					
	Signal voltage	[V DC]	0 ... 5 (for logic 0) 15 ... 30 (for logic 1)					
Digital outputs (short circuit proof)	Number		5					
	Output voltage		min. $V_b$ ... $V_b$ : -3 V DC (at 0.1 A)					
	Output current	[A]	Max. 0.1					
	Max. tripping current	[mA]	500					
Displacement encoder input MLO-POT-...	Operating voltage	[V DC]	+10					
	Input voltage	[V DC]	0 ... +10					
Displacement encoder input MME-MTS-...	Operating voltage	[V DC]			24			
	Communication				CAN fieldbus (1 Mbaud)			
Standard cylinder input DNCI	Operating voltage	[V DC]				5		
	Communication					sin/cos		
Linear drive input DGCI	Operating voltage	[V DC]					24	
	Communication						CAN fieldbus (1 Mbaud)	
Valve output	Operating voltage	[V DC]	24					
Valve output	Output voltage	[V DC]	0 ... +10					
Relative air humidity		[%]	95 (non-condensing)					
Weight		[g]	Approx. 400					

Operating and environmental conditions								
End position controller SPC11-...		Type	...-POT-TLF	...-POT-LWG	...-MTS-AIF	...-INC	...-MTS-AIF-2	
Temperature range		[°C]	0 ... +50					
Protection class to IEC 60529			IP65					
Vibration resistance, tested to DIN/IEC 68, Part 2-6			Severity level 2					
Shock resistance, tested to DIN/IEC 68, Part 2-27			Severity level 2					
CE mark (see declaration of conformity)			In accordance with EU EMC directive					

## End position controllers SPC11

Technical data

**FESTO**

**Dimensions** Download CAD data → [www.festo.com/en/engineering](http://www.festo.com/en/engineering)

SPC11-POT-TLF, SPC11-POT-LWG, SPC11-MTS-AIF

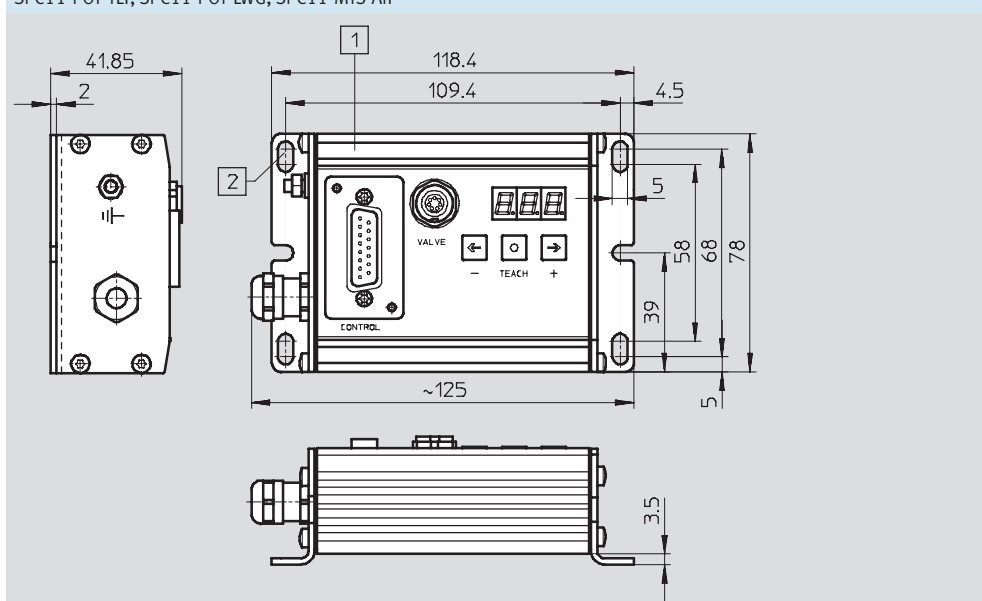

1 Slot for inscription labels:  
18182 IBS-9x20  
18576 IBS-6x10

2 Mounting options for M4 screws

SPC11-INC, SPC11-MTS-AIF-2

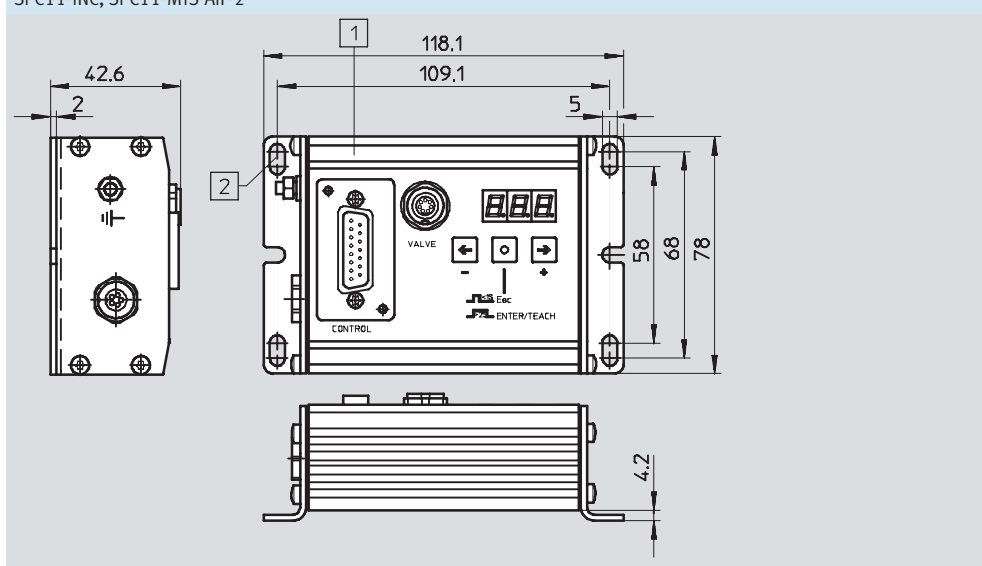

1 Slot for inscription labels:  
18182 IBS-9x20  
18576 IBS-6x10

2 Mounting options for M4 screws

Ordering data		
Description	Part No.	Type
For analogue displacement encoder MLO-POT-...-TLF, standard cylinder DNCM	192 216	SPC11-POT-TLF
For analogue displacement encoder MLO-POT-...-LWG, swivel module DSMI	192 217	SPC11-POT-LWG
For digital displacement encoder MME-MTS-...-AIF	192 218	SPC11-MTS-AIF
For standard cylinder DNCI	537 321	SPC11-INC
For linear drive DGCI	548 129	SPC11-MTS-AIF-2

# End position controllers SPC11

Technical data



## Order example

For pneumatic linear drives DGCI

A workpiece weighing 3 kg is to be moved horizontally on a loading station. A workpiece gripper attached

to the slide of the linear drive weighs 14 kg. The total weight to be moved is therefore 17 kg. The desired travel

distance is 1,100 mm. The travel time is to be < 1.5 seconds.

### Step 1:

#### Selecting the cylinder stroke

For a travel distance of 1,100 mm, use the table on → 5 / 1.4-13 to select the next-largest effective cylinder stroke of 1,250 mm. This column has a grey background.

### Step 2:

#### Specifying the drive

For a total weight of 17 kg to be moved horizontally, there is a choice of piston diameters of 25, 32 and 40 mm (see data for max. total weight to be moved).

For the purposes of our example, the drive DGCI-32-1250-KF..., part no. 544 427 has been selected.

### Step 3:

#### Specifying a proportional 5/3-way valve

The appropriate proportional 5/3-way valve is shown at the intersection of the grey column used in step 1 and the line for the selected linear drive DGCI-32-... in the "Proportional 5/3-way valve" section of the table. For the purposes of our example, the proportional 5/3-way valve MPYE-5-¼-010B, part no. 151 694 has been selected.

### Step 4:

#### Completing the order information

To order a complete system you must add the data for the end position controller, valve and controller cables and manual (if required). The complete ordering data for our example can be found on → 5 / 1.4-13. A manual should normally be ordered. If you already have one, leave the appropriate box blank, indicating that you do not want a manual.

### Step 5:

#### Determining the travel time

To calculate the travel time use the "Smart Soft Stop" software tool. The travel time for the order example is 1.16 seconds.



Selection and ordering aid for Smart Soft Stop and ProDrive  
[www.festo.com/en/engineering](http://www.festo.com/en/engineering)



Note

Remember when selecting the drive mounting components that some of these are not backlash-free and therefore cannot be used with the Smart Soft Stop system. The drives must be mounted directly.



Note

Check that the loads placed on the drive by a gripper during movement do not exceed permissible limits. To carry out simulation quickly and easily, use the Smart Soft Stop software tool and ProDrive.



Note

For vertical travel,  $t_{up}$  and  $t_{down}$  are the two different travel times.

## Ordering data

Pneumatic linear drive		Proportional 5/3-way valve		End position controller	
Part No.	Type	Part No.	Type	Part No.	Type
544 427	DGCI-32-1250-KF-...	151 694	MPYE-5-¼-010B	548 129	SPC11-MTS-AIF-2

Valve cable		Controller cable	
Part No.	Type	Part No.	Type
170 238	KMPYE-AIF-1-GS-GD-2	177 674	KMPV-SUB-D-15-10

# End position controllers SPC11

Technical data

FESTO

Step 1 and 2:																
Pneumatic linear drives/Type		DGCI-... <sup>1)</sup> ... <sup>2)</sup> -KF-...														
Effective cylinder stroke	[mm]	100	160	225	300	360	450	500	600	750	1,000	1,250	1,500	1,750	2,000	
Max. overall mass to be moved horizontally/vertically by $\varnothing$	18	15/5														
	25	30/10														
	32	45/15														
	40	70/25														
Part No. for $\varnothing$	18	544 425														
	25	544 426														
	32	544 427														
	40	544 428														

Step 3:																
Proportional 5/3-way valves <sup>3)</sup>		1 = 154 200 MPYE-5-M5-010-B					3 = 151 693 MPYE-5-1/8-HF-010-B									
Part No./Type		2 = 151 692 MPYE-5-1/8-LF-010-B					4 = 151 694 MPYE-5-1/4-010-B									
Effective cylinder stroke	[mm]	100	160	225	300	360	450	500	600	750	1,000	1,250	1,500	1,750	2,000	
Horizontal/vertical for $\varnothing$	18	1/1	1/1	1/1	1/1	2/2	2/2	2/2	2/2	2/2	2/2	2/2	2/2	2/2	3/3	
	25	2/2	2/2	2/2	2/2	3/2	3/2	3/2	3/2	3/2	3/3	3/3	3/3	3/3	3/3	
	32	2/2	3/2	3/2	3/2	3/3	3/3	3/3	3/3	3/3	3/3	4/3	4/3	4/3	4/4	
	40	3/2	3/2	3/2	3/3	3/3	3/3	3/3	4/3	4/3	4/3	4/4	4/4	4/4	4/4	

Step 5:				
End position controllers and accessories	Part No.	Type	Brief description	
End position controller	548 129	SPC11-MTS-AIF-2		
Cable	Valve	170 238	KMPYE-AIF-1-GS-GD-2	
		170 239	KMPYE-AIF-1-GS-GD-0,3	
	SPC11/PLC	177 673	KMPV-SUB-D-15-5	
		177 674	KMPV-SUB-D-15-10	
			Cable length 2 m	
			Cable length 0.3 m	
			Cable length 5 m	
			Cable length 10 m	

Note  
Manuals → 5 / 1.4-43

- 1) Indicate piston  $\varnothing$ . Technical data and dimensions → LEERER MERKER.
- 2) Indicate calculated effective stroke of cylinder.
- 3) Technical data and dimensions → 5 / 1.5-2.

# End position controllers SPC11

Technical data



## Accessories for the solution package for DGCI horizontally mounted

For effective cylinder stroke 100 ... 2,000 mm

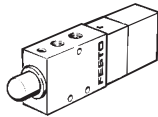
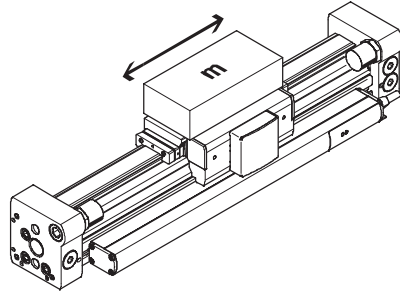

### Ordering data

Effective cylinder stroke DGCI-... [mm]	Proportional 5/3-way valve Type	Fittings <sup>1)</sup>				Compressed air tubing		Silencer <sup>2)</sup>	
		For MPYE-5-...		For DGCI		Part No.	Type	Part No.	Type
Ø 18 mm									
100 ... 160	MPYE-5-M5-010-B	153 306	QSM-M5-6	153 306	QSM-M5-6	152 586	PUN-6x1-SI	165 003	UC-M5
225 ... 300	MPYE-5-M5-010-B								
360 ... 1,750	MPYE-5-1/8-LF-010-B	153 002	QS-1/8-6	153 306	QSM-M5-6	152 586	PUN-6x1-SI	2307	U-1/8
2,000	MPYE-5-1/8-HF-010-B								
Ø 25 mm									
100 ... 160	MPYE-5-1/8-LF-010-B	153 002	QS-1/8-6	153 002	QS-1/8-6	152 586	PUN-6x1-SI	2307	U-1/8
225 ... 300	MPYE-5-1/8-LF-010-B	153 004	QS-1/8-8	153 004	QS-1/8-8	152 587	PUN-8x1,25-SI	2307	U-1/8
360 ... 2,000	MPYE-5-1/8-HF-010-B								
Ø 32 mm									
100	MPYE-5-1/8-LF-010-B	153 002	QS-1/8-6	153 002	QS-1/8-6	152 586	PUN-6x1-SI	2307	U-1/8
160 ... 1,000	MPYE-5-1/8-HF-010-B	153 004	QS-1/8-8	153 004	QS-1/8-8	152 587	PUN-8x1,25-SI		
1,250 ... 2,000	MPYE-5-1/4-010-B	153 005	QS-1/4-8					2316	U-1/4
Ø 40 mm									
100 ... 160	MPYE-5-1/8-HF-010-B	153 004	QS-1/8-8	153 005	QS-1/4-8	152 587	PUN-8x1,25-SI	2307	U-1/8
225 ... 500	MPYE-5-1/8-HF-010-B								
600 ... 750	MPYE-5-1/4-010-B	153 005	QS-1/4-8	153 005	QS-1/4-8	152 587	PUN-8x1,25-SI	2316	U-1/4
1,000 ... 2,000	MPYE-5-1/4-010-B	153 007	QS-1/4-10	153 007	QS-1/4-10	152 588	PUN-10x1,5-SI	2316	U-1/4

1) Fittings sold only in packs of 10.

2) 2 pieces are required.

# End position controllers SPC11

Technical data

FESTO

## Accessories for the solution package for DGCI horizontally mounted

For effective cylinder stroke 100 ... 2,000 mm

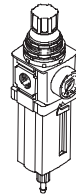
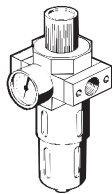

Ordering data									
Effective cylinder stroke DGCI... [mm]	Filter regulator, D series with filter cartridge 5 µm			Filter cartridge 5 µm D series		Filter regulator, MS series with filter cartridge 5 µm		Filter cartridge 5 µm MS series	
	Part No.	Type	Part No.	Type	Part No.	Type	Part No.	Type	
Ø 18 mm									
100 ... 2,000	162 719	LFR-¼-D-5M-MINI	159 640	LFP-D-MINI-5M	529 152	MS4-LFR-¼-D7-CRM-AS	534 501	MS4-LFP-C	
Ø 25 mm									
100 ... 2,000	162 719	LFR-¼-D-5M-MINI	159 640	LFP-D-MINI-5M	529 152	MS4-LFR-¼-D7-CRM-AS	534 501	MS4-LFP-C	
Ø 32 mm									
100 ... 1,000	162 719	LFR-¼-D-5M-MINI	159 640	LFP-D-MINI-5M	529 152	MS4-LFR-¼-D7-CRM-AS	534 501	MS4-LFP-C	
1,250 ... 2,000	162 721	LFR-⅜-D-5M-MIDI	159 594	LFP-D-MIDI-5M	529 204	MS6-LFR-¼-D7-CRM-AS	534 499	MS6-LFP-C	
Ø 40 mm									
100 ... 500	162 719	LFR-¼-D-5M-MINI	159 640	LFP-D-MINI-5M	529 152	MS4-LFR-¼-D7-CRM-AS	534 501	MS4-LFP-C	
600 ... 2,000	162 721	LFR-⅜-D-5M-MIDI	159 594	LFP-D-MIDI-5M	529 204	MS6-LFR-¼-D7-CRM-AS	534 499	MS6-LFP-C	

# End position controllers SPC11

Technical data



## Accessories for the solution package for DGCI vertically mounted

For effective cylinder stroke 100 ... 2,000 mm

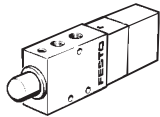
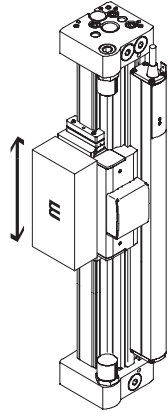

Ordering data									
Effective cylinder stroke DGCI [mm]	Proportional 5/3-way valve Type	Fittings <sup>1)</sup>				Compressed air tubing		Silencer <sup>2)</sup>	
		For MPYE-5-...		DGCI		Part No.	Type	Part No.	Type
Ø 18 mm									
100 ... 300	MPYE-5-M5-010-B	153 306	QSM-M5-6	153 306	QSM-M5-6	152 586	PUN-6x1-SI	165 003	UC-M5
360 ... 1,750	MPYE-5-1/8-LF-010-B	153 002	QS-1/8-6					2307	U-1/8
2,000	MPYE-5-1/8-HF-010-B								
Ø 25 mm									
100 ... 160	MPYE-5-1/8-LF-010-B	153 002	QS-1/8-6	153 002	QS-1/8-6	152 586	PUN-6x1-SI	2307	U-1/8
225 ... 750	MPYE-5-1/8-LF-010-B	153 004	QS-1/8-8	153 004	QS-1/8-8	152 587	PUN-8x1,25-SI		
1,000 ... 2,000	MPYE-5-1/8-HF-010-B								
Ø 32 mm									
100	MPYE-5-1/8-LF-010-B	153 002	QS-1/8-6	153 002	QS-1/8-6	152 586	PUN-6x1-SI	2307	U-1/8
160 ... 300	MPYE-5-1/8-LF-010-B	153 004	QS-1/8-8	153 004	QS-1/8-8	152 587	PUN-8x1,25-SI	2307	U-1/8
360 ... 1,750	MPYE-5-1/8-HF-010-B								
2,000	MPYE-5-1/4-010-B	153 005	QS-1/4-8					2316	U-1/4
Ø 40 mm									
100 ... 225	MPYE-5-1/8-LF-010-B	153 004	QS-1/8-8	153 005	QS-1/4-8	152 587	PUN-8x1,25-SI	2307	U-1/8
300 ... 750	MPYE-5-1/8-HF-010-B								
1,000	MPYE-5-1/8-HF-010-B	190 643	QS-1/8-10	153 007	QS-1/4-10	152 588	PUN-10x1,5-SI		
1,250 ... 2,000	MPYE-5-1/4-010-B	153 007	QS-1/4-10					2316	U-1/4

1) Fittings sold only in packs of 10.

2) 2 pieces are required.



# End position controllers SPC11

Technical data

FESTO

## Accessories for the solution package for DGCI vertically mounted

For effective cylinder stroke 100 ... 2,000 mm

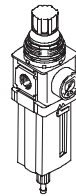
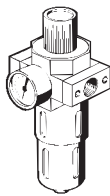

Ordering data								
Effective cylinder stroke DGCI [mm]	Filter regulator, D series with filter cartridge 5 µm		Filter cartridge 5 µm D series		Filter regulator, MS series with filter cartridge 5 µm		Filter cartridge 5 µm MS series	
	Part No.	Type	Part No.	Type	Part No.	Type	Part No.	Type
Ø 18 mm								
100 ... 2,000	162 719	LFR-¼-D-5M-MINI	159 640	LFP-D-MINI-5M	529 152	MS4-LFR-¼-D7-CRM-AS	534 501	MS4-LFP-C
Ø 25 mm								
100 ... 2,000	162 719	LFR-¼-D-5M-MINI	159 640	LFP-D-MINI-5M	529 152	MS4-LFR-¼-D7-CRM-AS	534 501	MS4-LFP-C
Ø 32 mm								
100 ... 1,000	162 719	LFR-¼-D-5M-MINI	159 640	LFP-D-MINI-5M	529 152	MS4-LFR-¼-D7-CRM-AS	534 501	MS4-LFP-C
1,250 ... 2,000	162 721	LFR-¾-D-5M-MIDI	159 594	LFP-D-MIDI-5M	529 204	MS6-LFR-¼-D7-CRM-AS	534 499	MS6-LFP-C
Ø 40 mm								
100 ... 500	162 719	LFR-¼-D-5M-MINI	159 640	LFP-D-MINI-5M	529 152	MS4-LFR-¼-D7-CRM-AS	534 501	MS4-LFP-C
600 ... 2,000	162 721	LFR-¾-D-5M-MIDI	159 594	LFP-D-MIDI-5M	529 204	MS6-LFR-¼-D7-CRM-AS	534 499	MS6-LFP-C

# End position controllers SPC11

Technical data



## Order example

For pneumatic linear drives DGP/DGPL, DGPI/DGPIL

A workpiece weighing 3 kg is to be moved horizontally on a loading station. A workpiece gripper attached

to the slide of the linear drive weighs 14 kg. The total weight to be moved is therefore 17 kg. The desired travel

distance is 1,100 mm. The travel time is to be < 1.5 seconds.

### Step 1:

#### Selecting the cylinder stroke

For a travel distance of 1,100 mm, use the table on → 5 / 1.4-19 to select the next-largest effective cylinder stroke of 1,250 mm. This column has a grey background.

### Step 2:

#### Specifying the drive

For a total weight of 17 kg to be moved horizontally, there is a choice of piston diameters of 25, 32, 40, 50 and 63 mm (see data for max. total weight to be moved).

For the purposes of our example, the drive DGPL-32-1250-PPV-A-B-KF-GK-...-D2, part no. 175 135 has been selected.

### Step 3:

#### Specifying the displacement encoder

The appropriate length of the displacement encoder is governed by the effective cylinder stroke.

The column with the grey background in the "Displacement encoder" section of the table shows Part No. 152 633 for this example.

Alternatively, the digital displacement encoder MME-MTS-...-AIF can be used.

### Step 4:

#### Specifying a proportional 5/3-way valve

The appropriate proportional 5/3-way valve is shown at the intersection of the grey column used in step 1 and the line for the selected linear drive DGPL-32-... in the "Proportional 5/3-way valve" section of the table. For the purposes of our example, the proportional 5/3-way valve MPYE-5-¼-010B, part no. 151 694 has been selected.

### Step 5:

#### Completing the order information

To order a complete system you must add the data for the end position controller, valve and controller cables and manual (if required). The complete ordering data for our example can be found on → 5 / 1.4-19. A manual should normally be ordered. If you already have one, leave the appropriate box blank, indicating that you do not want a manual.

### Step 6:

#### Determining the travel time

To calculate the travel time use the "Smart Soft Stop" software tool. The travel time for the order example is 1.16 seconds.



Selection and ordering aid for Smart Soft Stop and ProDrive  
[www.festo.com/en/engineering](http://www.festo.com/en/engineering)



Note

Remember when selecting the drive mounting components that some of these are not backlash-free and therefore cannot be used with the Smart Soft Stop system. The drives must be mounted directly.



Note

Check that the loads placed on the drive by a gripper during movement do not exceed permissible limits. To carry out simulation quickly and easily, use the Smart Soft Stop software tool and ProDrive.



Note

The moment compensator FKP is not backlash-free. It must not therefore be used in combination with linear drives DGP/DGPL.



Note

For vertical travel,  $t_{up}$  and  $t_{down}$  are the two different travel times.

## Ordering data

Pneumatic linear drive		Displacement encoder		Proportional 5/3-way valve		End position controller	
Part No.	Type	Part No.	Type	Part No.	Type	Part No.	Type
175 135	DGPL-32-1250-PPV-A-B-KF-GK-...-D2	152 633	MLO-POT-1250-TLF	151 694	MPYE-5-¼-010B	192 216	SPC11-POT-TLF

Valve cable		Controller cable	
Part No.	Type	Part No.	Type
170 238	KMPYE-AIF-1-GS-GD-2	177 674	KMPV-SUB-D-15-10

# End position controllers SPC11

Technical data

FESTO

Step 1 and 2:													
Pneumatic linear drives/Type		DGP-... <sup>1)</sup> ... <sup>3)</sup> -PPV-A-B-D2 DGPL-... <sup>1)</sup> ... <sup>3)</sup> -PPV-A-KF-B-GK-...-D2					DGPI-... <sup>2)</sup> ... <sup>3)</sup> -PPV-A-B-D2 DGPI-... <sup>2)</sup> ... <sup>3)</sup> -PPV-A-B-KF-...-D2						
Effective cylinder stroke	[mm]	225	300	360	450	500	600	750	1,000	1,250	1,500	1,750	2,000
Max. overall mass to be moved horizontally/ vertically by Ø	25	30/10 kg											
	32	45/15 kg											
	40	70/25 kg											
	50	120/40 kg											
Part No. for Ø	63	180/60 kg											
	25	175 134											
	32	175 135											
	40	175 136											
	50	175 137											
	63	175 138											

Step 3:													
Displacement encoder <sup>5)</sup>		MLO-POT-...-TLF MME-MTS-...-AIF											
Effective cylinder stroke	[mm]	225	300	360	450	500	600	750	1,000	1,250	1,500	1,750	2,000
Potentiometer length	[mm]	225	300	360	450	500	600	750	1,000	1,250	1,500	1,750	2,000
Part No.	MLO-POT-...-TLF	152625	152626	152627	152628	152629	152630	152631	152632	152633	152634	152635	152636
	MME-MTS-...-AIF	178310	178309	178308	178307	178306	178305	178304	178303	178302	178301	178300	178299

Step 4:													
Proportional 5/3-way valves <sup>6)</sup>		1 = 151 692 MPYE-5-1/8-LF-010-B					3 = 151 694 MPYE-5-1/4-010-B						
Part No./Type		2 = 151 693 MPYE-5-1/8-HF-010-B					4 = 151 695 MPYE-5-3/8-010-B						
Effective cylinder stroke	[mm]	225	300	360	450	500	600	750	1,000	1,250	1,500	1,750	2,000
Horizontal/vertical for Ø	25	1 <sup>4)</sup>	1/1	2/1	2/1	2/1	2/2	2/2	2/3	2/3	2/3	2/3	2/3
	32	1 <sup>4)</sup>	2/1	2/1	2/1	2/1	2/1	3/2	3/3	3/3	3/3	3/3	3/3
	40	2/1	2/1	2/1	2/1	2/2	3/3	3/4	3/4	3/4	3/4	3/4	3/4
	50	1/1	2/1	2/2	3/2	3/3	4/3	4/4	4/4	4/4	4/4	4/4	4/4
	63	2/1	2/2	3/3	3/3	4/4	4/4	4/4	4/4	4/4	4/4	4/4	4/4

Step 5:				
End position controllers and accessories		Part No.	Type	Brief description
End position controller	SPC11	<b>192 216</b>	<b>SPC11-POT-TLF</b>	
		<b>192 218</b>	<b>SPC11-MTS-AIF</b>	
Cable	Valve	<b>170 238</b>	<b>KMPYE-AIF-1-GS-GD-2</b>	Cable length 2 m
		<b>170 239</b>	<b>KMPYE-AIF-1-GS-GD-0,3</b>	Cable length 0.3 m
	SPC11/PLC	<b>177 673</b>	<b>KMPV-SUB-D-15-5</b>	Cable length 5 m
		<b>177 674</b>	<b>KMPV-SUB-D-15-10</b>	Cable length 10 m

Note  
Manuals → 5 / 1.4-43

- 1) Indicate piston Ø. Technical data and dimensions → LEERER MERKER.
- 2) Indicate piston Ø. Technical data and dimensions → LEERER MERKER.
- 3) Indicate calculated effective stroke of cylinder.
- 4) On request
- 5) Technical data and dimensions → 5 / 1.2-2.  
(not needed for DGPI/DGPIL, has integrated displacement encoder).
- 6) Technical data and dimensions → 5 / 1.5-2.

# End position controllers SPC11

Technical data



## Accessories for the solution package for DGP/DGPL, DGPI/DGPIL horizontally mounted

For effective cylinder stroke 225 ... 2,000 mm

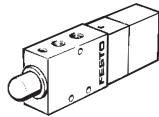
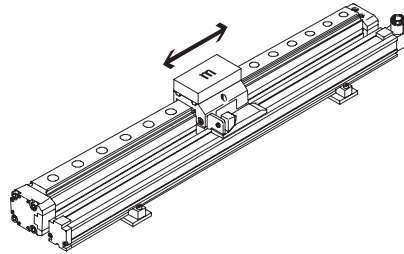

### Ordering data

Effective cylinder stroke DGP/L, DGPI/L-... [mm]	Proportional 5/3-way valve  Type	Fittings <sup>1)</sup>				Compressed air tubing		Silencer <sup>2)</sup>	
		For MPYE-5-...		DGP/L, DGPI/L		Part No.	Type	Part No.	Type
		Part No.	Type	Part No.	Type				
<b>Ø 25 mm</b>									
225 ... 300	MPYE-5-1/8-LF-010-B	153 004	QS-1/8-8	153 004	QS-1/8-8	152 587	PUN-8x1,25	2307	U-1/8
360 ... 2,000	MPYE-5-1/8-HF-010-B								
<b>Ø 32 mm</b>									
225	MPYE-5-1/8-LF-010-B	153 004	QS-1/8-8	153 004	QS-1/8-8	152 587	PUN-8x1,25	2307	U-1/8
300 ... 600	MPYE-5-1/8-HF-010-B								
750 ... 2,000	MPYE-5-1/4-010-B	153 005	QS-1/4-8	153 004	QS-1/8-8	152 587	PUN-8x1,25	2316	U-1/4
<b>Ø 40 mm</b>									
225 ... 500	MPYE-5-1/8-HF-010-B	153 004	QS-1/8-8	153 005	QS-1/4-8	152 587	PUN-8x1,25	2307	U-1/8
600 ... 2,000	MPYE-5-1/4-010-B	153 007	QS-1/4-10	153 007	QS-1/4-10	152 588	PUN-10x1,5	2316	U-1/4
<b>Ø 50 mm</b>									
225	MPYE-5-1/8-LF-010-B	153 004	QS-1/8-8	153 005	QS-1/4-8	152 587	PUN-8x1,25	2307	U-1/8
300 ... 360	MPYE-5-1/8-HF-010-B								
450 ... 500	MPYE-5-1/4-010-B	153 007	QS-1/4-10	153 007	QS-1/4-10	152 588	PUN-10x1,5	2316	U-1/4
600 ... 2,000	MPYE-5-3/8-010-B	153 008	QS-3/8-10					2309	U-3/8
<b>Ø 63 mm</b>									
225 ... 300	MPYE-5-1/8-HF-010-B	153 004	QS-1/8-8	153 006	QS-3/8-8	152 587	PUN-8x1,25	2307	U-1/8
360 ... 450	MPYE-5-1/4-010-B	153 007	QS-1/4-10	153 008	QS-3/8-10	152 588	PUN-10x1,5	2316	U-1/4
500 ... 2,000	MPYE-5-3/8-010-B	153 009	QS-3/8-12	153 009	QS-3/8-12	152 589	PUN-12x2	2309	U-3/8

1) Fittings sold only in packs of 10.

2) 2 pieces are required.

# End position controllers SPC11

Technical data

FESTO

**Accessories for the solution package for DGP/DGPL, DGPI/DGPIL horizontally mounted**  
 For effective cylinder stroke 225 ... 2,000 mm

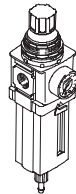
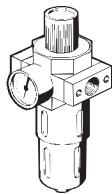

Ordering data									
Effective cylinder stroke DGP/L, DGPI/L-... [mm]	Filter regulator, D series with filter cartridge 5 µm			Filter cartridge 5 µm D series		Filter regulator, MS series with filter cartridge 5 µm		Filter cartridge 5 µm MS series	
	Part No.	Type	Part No.	Type	Part No.	Type	Part No.	Type	
<b>Ø 25 mm</b>									
225 ... 2,000	162 719	LFR-¼-D-5M-MINI	159 640	LFP-D-MINI-5M	529 152	MS4-LFR-¼-D7-CRM-AS	534 501	MS4-LFP-C	
<b>Ø 32 mm</b>									
225 ... 600	162 719	LFR-¼-D-5M-MINI	159 640	LFP-D-MINI-5M	529 152	MS4-LFR-¼-D7-CRM-AS	534 501	MS4-LFP-C	
750 ... 2,000	162 721	LFR-⅜-D-5M-MIDI	159 594	LFP-D-MIDI-5M	529 204	MS6-LFR-¼-D7-CRM-AS	534 499	MS6-LFP-C	
<b>Ø 40 mm</b>									
225 ... 500	162 719	LFR-¼-D-5M-MINI	159 640	LFP-D-MINI-5M	529 152	MS4-LFR-¼-D7-CRM-AS	534 501	MS4-LFP-C	
600 ... 2,000	162 721	LFR-⅜-D-5M-MIDI	159 594	LFP-D-MIDI-5M	529 204	MS6-LFR-¼-D7-CRM-AS	534 499	MS6-LFP-C	
<b>Ø 50 mm</b>									
225 ... 360	162 719	LFR-¼-D-5M-MINI	159 640	LFP-D-MINI-5M	529 152	MS4-LFR-¼-D7-CRM-AS	534 501	MS4-LFP-C	
450 ... 500	162 721	LFR-⅜-D-5M-MIDI	159 594	LFP-D-MIDI-5M	529 204	MS6-LFR-¼-D7-CRM-AS	534 499	MS6-LFP-C	
600 ... 2,000	162 724	LFR-¾-D-5M-MAXI	159 641	LFP-D-MAXI-5M	529 224	MS6-LFR-⅜-D7-CRM-AS	534 499	MS6-LFP-C	
<b>Ø 63 mm</b>									
225 ... 300	162 719	LFR-¼-D-5M-MINI	159 640	LFP-D-MINI-5M	529 152	MS4-LFR-¼-D7-CRM-AS	534 501	MS4-LFP-C	
360 ... 450	162 721	LFR-⅜-D-5M-MIDI	159 594	LFP-D-MIDI-5M	529 204	MS6-LFR-¼-D7-CRM-AS	534 499	MS6-LFP-C	
500 ... 2,000	162 724	LFR-¾-D-5M-MAXI	159 641	LFP-D-MAXI-5M	529 224	MS6-LFR-⅜-D7-CRM-AS	534 499	MS6-LFP-C	

Servopneumatic positioning systems  
 Electronic end-position cushioning

1.4

# End position controllers SPC11

Technical data

FESTO

## Accessories for the solution package for DGP/DGPL, DGPI/DGPIL vertically mounted

For effective cylinder stroke 225 ... 2,000 mm

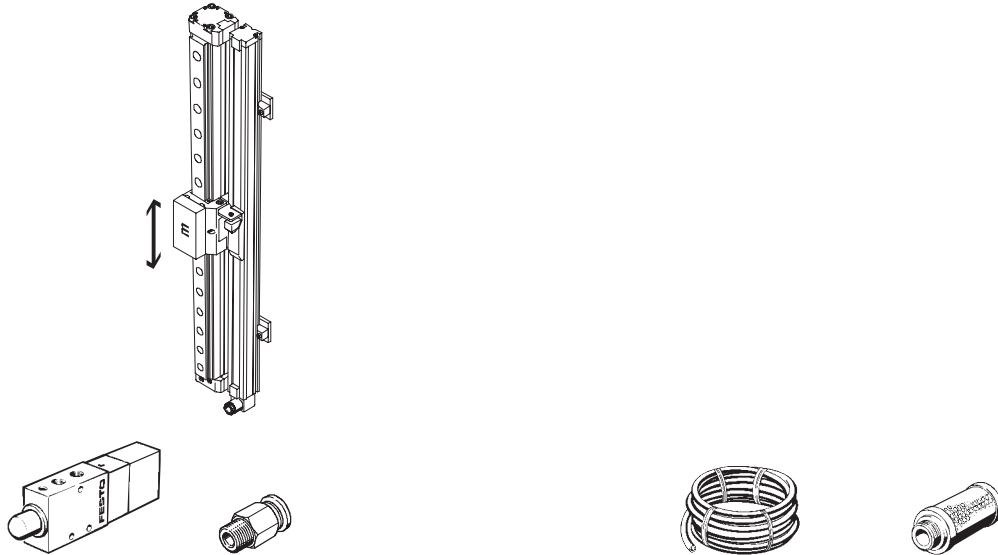

Ordering data									
Effective cylinder stroke DGP/L, DGPI/L [mm]	Proportional 5/3-way valve Type	Fittings <sup>1)</sup>				Compressed air tubing		Silencer <sup>2)</sup>	
		For MPYE-5-...		DGP/L, DGPI/L		Part No.	Type	Part No.	Type
		Part No.	Type	Part No.	Type			Part No.	Type
<b>Ø 25 mm</b>									
225 ... 500	MPYE-5-1/8-LF-010-B	153 004	QS-1/8-8	153 004	QS-1/8-8	152 587	PUN-8x1,25	2307	U-1/8
600 ... 750	MPYE-5-1/8-HF-010-B								
1,000 ... 2,000	MPYE-5-1/4-010-B	153 005	QS-1/4-8					2316	U-1/4
<b>Ø 32 mm</b>									
225 ... 600	MPYE-5-1/8-LF-010-B	153 004	QS-1/8-8	153 004	QS-1/8-8	152 587	PUN-8x1,25	2307	U-1/8
750	MPYE-5-1/8-HF-010-B								
1,000 ... 2,000	MPYE-5-1/4-010-B	153 005	QS-1/4-8					2316	U-1/4
<b>Ø 40 mm</b>									
225 ... 450	MPYE-5-1/8-LF-010-B	153 004	QS-1/8-8	153 005	QS-1/4-8	152 587	PUN-8x1,25	2307	U-1/8
500	MPYE-5-1/8-HF-010-B			153 005	QS-1/4-8				
600	MPYE-5-1/4-010-B	153 007	QS-1/4-10	153 007	QS-1/4-10	152 588	PUN-10x1,5	2316	U-1/4
750 ... 2,000	MPYE-5-3/8-010-B	153 008	QS-3/8-10					2309	U-3/8
<b>Ø 50 mm</b>									
225 ... 300	MPYE-5-1/8-LF-010-B	153 004	QS-1/8-8	153 005	QS-1/4-8	152 587	PUN-8x1,25	2307	U-1/8
360 ... 450	MPYE-5-1/8-HF-010-B								
500 ... 600	MPYE-5-1/4-010-B	153 007	QS-1/4-10	153 007	QS-1/4-10	152 588	PUN-10x1,5	2316	U-1/4
750 ... 2,000	MPYE-5-3/8-010-B	153 008	QS-3/8-10					2309	U-3/8
<b>Ø 63 mm</b>									
225	MPYE-5-1/8-LF-010-B	153 004	QS-1/8-8	153 006	QS-3/8-8	152 587	PUN-8x1,25	2307	U-1/8
300	MPYE-5-1/8-HF-010-B								
360 ... 450	MPYE-5-1/4-010-B	153 007	QS-1/4-10	153 008	QS-3/8-10	152 588	PUN-10x1,5	2316	U-1/4
500 ... 2,000	MPYE-5-3/8-010-B	153 009	QS-3/8-12	153 009	QS-3/8-12	152 589	PUN-12x2	2309	U-3/8

1) Fittings sold only in packs of 10.

2) 2 pieces are required.

# End position controllers SPC11

Technical data

FESTO

**Accessories for the solution package for DGP/DGPL, DGPI/DGPIL vertically mounted**  
 For effective cylinder stroke 225 ... 2,000 mm

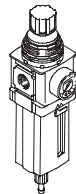
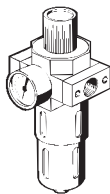

Ordering data									
Effective cylinder stroke DGP/L, DGPI/L [mm]	Filter regulator, D series with filter cartridge 5 µm			Filter cartridge 5 µm D series		Filter regulator, MS series with filter cartridge 5 µm		Filter cartridge 5 µm MS series	
	Part No.	Type	Part No.	Type	Part No.	Type	Part No.	Type	
<b>Ø 25 mm</b>									
225 ... 750	162 719	LFR-¼-D-5M-MINI	159 640	LFP-D-MINI-5M	529 152	MS4-LFR-¼-D7-CRM-AS	534 501	MS4-LFP-C	
1,000 ... 2,000	162 721	LFR-¾-D-5M-MIDI	159 594	LFP-D-MIDI-5M	529 204	MS6-LFR-¼-D7-CRM-AS	534 499	MS6-LFP-C	
<b>Ø 32 mm</b>									
225 ... 750	162 719	LFR-¼-D-5M-MINI	159 640	LFP-D-MINI-5M	529 152	MS4-LFR-¼-D7-CRM-AS	534 501	MS4-LFP-C	
1,000 ... 2,000	162 721	LFR-¾-D-5M-MIDI	159 594	LFP-D-MIDI-5M	529 204	MS6-LFR-¼-D7-CRM-AS	534 499	MS6-LFP-C	
<b>Ø 40 mm</b>									
225 ... 500	162 719	LFR-¼-D-5M-MINI	159 640	LFP-D-MINI-5M	529 152	MS4-LFR-¼-D7-CRM-AS	534 501	MS4-LFP-C	
600	162 721	LFR-¾-D-5M-MIDI	159 594	LFP-D-MIDI-5M	529 204	MS6-LFR-¼-D7-CRM-AS	534 499	MS6-LFP-C	
750 ... 2,000	162 724	LFR-¾-D-5M-MAXI	159 641	LFP-D-MAXI-5M	529 224	MS6-LFR-¾-D7-CRM-AS			
<b>Ø 50 mm</b>									
225 ... 300	162 719	LFR-¼-D-5M-MINI	159 640	LFP-D-MINI-5M	529 152	MS4-LFR-¼-D7-CRM-AS	534 501	MS4-LFP-C	
360 ... 600	162 721	LFR-¾-D-5M-MIDI	159 594	LFP-D-MIDI-5M	529 204	MS6-LFR-¼-D7-CRM-AS	534 499	MS6-LFP-C	
750 ... 2,000	162 724	LFR-¾-D-5M-MAXI	159 641	LFP-D-MAXI-5M	529 224	MS6-LFR-¾-D7-CRM-AS			
<b>Ø 63 mm</b>									
225 ... 300	162 719	LFR-¼-D-5M-MINI	159 640	LFP-D-MINI-5M	529 152	MS4-LFR-¼-D7-CRM-AS	534 501	MS4-LFP-C	
360 ... 450	162 721	LFR-¾-D-5M-MIDI	159 594	LFP-D-MIDI-5M	529 204	MS6-LFR-¼-D7-CRM-AS	534 499	MS6-LFP-C	
500 ... 2,000	162 724	LFR-¾-D-5M-MAXI	159 641	LFP-D-MAXI-5M	529 224	MS6-LFR-¾-D7-CRM-AS			

# End position controllers SPC11

Technical data



## Order example

For the pneumatic drive DNC with displacement encoder LWG

A workpiece weighing 55 kg is to be moved horizontally on a loading station. The workpiece gripper attached to the piston rod of the drive weighs 40 kg. The total weight to be moved is therefore 95 kg. The desired travel distance is 300 mm. The travel time is to be < 1.5 seconds.

### Step 1: Selecting the cylinder stroke

For a travel distance of 300 mm, use the table on → 5 / 1.4-25 to select the next-largest standard stroke of 320 mm or the effective cylinder stroke of 291 ... 350 mm. This column has a grey background.

### Step 2: Specifying the drive

For a total weight of 95 kg to be moved horizontally, there is a choice of piston diameters of 50, 63 and 80 mm (see data for max. total weight to be moved).  
For the purposes of our example, the drive DNC-50-320-PPV-A, part no. 163 378 has been selected.

### Step 3: Specifying the displacement encoder

The appropriate length of the displacement encoder is governed by the effective cylinder stroke. The column with the grey background in the "Displacement encoder" section of the table shows Part No. 152 647 for this example.

Note  
The linear potentiometer is supplied separately and must be mounted by the user.

### Step 4: Specifying a proportional 5/3-way valve

The appropriate proportional 5/3-way valve is shown at the intersection of the grey column used in step 1 and the line for the selected pneumatic drive DNC-50... in the "Proportional 5/3-way valve" section of the table. For the purposes of our example, the proportional 5/3-way valve MPYE-5-1/8- HF-010B, part no. 151 693 has been selected.

### Step 5: Completing the order information

To order a complete system you must add the data for the end position controller, valve and controller cables and manual (if required). The complete ordering data for our example can be found on → 5 / 1.4-25. A manual should normally be ordered. If you already have one, leave the appropriate box blank, indicating that you do not want a manual.

### Step 6: Determining the travel time

To calculate the travel time use the "Smart Soft Stop" software tool. The travel time for the order example is 0.96 seconds.

Note  
Selection and ordering aid for Smart Soft Stop and ProDrive  
[www.festo.com/en/engineering](http://www.festo.com/en/engineering)

Note  
Remember when selecting the drive mounting components that some of these are not backlash-free and therefore cannot be used with the Smart Soft Stop system. The drives must be mounted directly.

Note  
Check that the loads placed on the drive by a gripper during movement do not exceed permissible limits. To carry out simulation quickly and easily, use the Smart Soft Stop software tool.

Note  
The self-aligning rod coupler FK is not backlash-free. It must not therefore be used in combination with standard cylinder DNC.

Ordering data							
Pneumatic drive		Displacement encoder		Proportional 5/3-way valve		End position controller	
Part No.	Type	Part No.	Type	Part No.	Type	Part No.	Type
163 378	DNC-50-320-PPV-A	152 647	MLO-POT-360-LWG	151 693	MPYE-5-1/8-HF-010B	192 217	SPC11-POT-LWG

Valve cable		Controller cable	
Part No.	Type	Part No.	Type
170 238	KMPYE-AIF-1-GS-GD-2	177 674	KMPV-SUB-D-15-10



# End position controllers SPC11

Technical data

FESTO

Step 1 and 2:											
Standard cylinders/Type		DNC-... <sup>1)</sup> ... <sup>2)</sup> -PPV-A									
Max. effective cylinder stroke	[mm]	100	150	150	225	225	300	360	450	600	750
Effective cylinder stroke (standard stroke)	[mm]	80	100	125	160	200	250	320	400	500	650
Max. overall mass to be moved horizontally by $\varnothing$	32	45 kg									
	40	75 kg									
	50	120 kg									
	63	180 kg									
Part No. for $\varnothing$	32	163 308	163 309	163 310	163 311	163 312	163 313	163 314	163 315	163 316	163 304
	40	163 340	163 341	163 342	163 343	163 344	163 345	163 346	163 347	163 348	163 336
	50	163 372	163 373	163 374	163 375	163 376	163 377	163 378	163 379	163 380	163 368
	63	163 404	163 405	163 406	163 407	163 408	163 409	163 410	163 411	163 412	163 400
Part No.	80	163 436	163 437	163 438	163 439	163 440	163 441	163 442	163 443	163 444	163 432

Step 3:											
Displacement encoder <sup>3)</sup>		MLO-POT-...-LWG									
Max. effective cylinder stroke	[mm]	100	150	150	225	225	300	360	450	600	750
Potentiometer length	[mm]	100	150	150	225	225	300	360	450	600	750
Part No.		192 213	192 214	192 214	152 645	152 645	152 646	152 647	152 648	152 650	152 651

Step 4:											
Proportional 5/3-way valves <sup>4)</sup>		1 = 151 692 MPYE-5-1/8-LF-010-B					3 = 151 694 MPYE-5-1/4-010-B				
Part No./Type		2 = 151 693 MPYE-5-1/8-HF-010-B					4 = 151 695 MPYE-5-3/8-010-B				
Max. effective cylinder stroke	[mm]	100	150	150	225	225	300	360	450	600	750
Horizontal for $\varnothing$	32	1	1	1	1	1	1	1	1	2	2
	40	1	1	1	1	1	1	2	2	3	3
	50	1	1	1	1	1	1	2	2	3	3
	63	1	1	1	1	2	2	2	3	3	4
	80	1	1	2	2	3	3	3	3	4	4

Step 5:			
End position controllers and accessories	Part No.	Type	Brief description
End position controller	192 217	SPC11-POT-LWG	
Cable	170 238	KMPYE-AIF-1-GS-GD-2	Cable length 2 m
	170 239	KMPYE-AIF-1-GS-GD-0,3	Cable length 0.3 m
SPC11/PLC	177 673	KMPV-SUB-D-15-5	Cable length 5 m
	177 674	KMPV-SUB-D-15-10	Cable length 10 m

-  - Note  
Manuals → 5 / 1.4-43

- 1) Indicate piston  $\varnothing$ . Technical data and dimensions → Volume 1.
- 2) Indicate calculated effective stroke of cylinder.
- 3) Technical data and dimensions → 5 / 1.2-2.
- 4) Technical data and dimensions → 5 / 1.5-2.

# End position controllers SPC11

Technical data



## Accessories for the solution package for DNC horizontally mounted

For effective cylinder stroke 80 ...750 mm

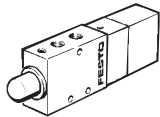
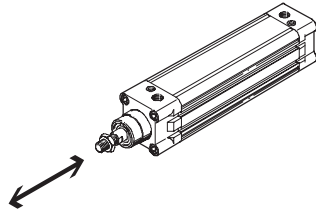

### Ordering data

Effective cylinder stroke DNC-... [mm]	Proportional 5/3-way valve Type	Fittings <sup>1)</sup>				Compressed air tubing		Silencer <sup>2)</sup>	
		For MPYE-5-...		DNC		Part No.	Type	Part No.	Type
<b>Ø 32 mm</b>									
80 ... 440	MPYE-5-1/8-LF-010-B	153 004	QS-1/8-8	153 004	QS-1/8-8	152 587	PUN-8x1,25	2307	U-1/8
441 ... 735	MPYE-5-1/8-HF-010-B								
<b>Ø 40 mm</b>									
80 ... 290	MPYE-5-1/8-LF-010-B	153 004	QS-1/8-8	153 005	QS-1/4-8	152 587	PUN-8x1,25	2307	U-1/8
291 ... 440	MPYE-5-1/8-HF-010-B			153 005	QS-1/4-8				
441 ... 735	MPYE-5-1/4-010-B	153 007	QS-1/4-10	153 007	QS-1/4-10	152 588	PUN-10x1,5	2316	U-1/4
<b>Ø 50 mm</b>									
80 ... 290	MPYE-5-1/8-LF-010-B	153 004	QS-1/8-8	153 005	QS-1/4-8	152 587	PUN-8x1,25	2307	U-1/8
291 ... 440	MPYE-5-1/8-HF-010-B								
441 ... 735	MPYE-5-1/4-010-B	153 007	QS-1/4-10	153 007	QS-1/4-10	152 588	PUN-10x1,5	2316	U-1/4
<b>Ø 63 mm</b>									
80 ... 175	MPYE-5-1/8-LF-010-B	153 004	QS-1/8-8	153 006	QS-3/8-8	152 587	PUN-8x1,25	2307	U-1/8
176 ... 350	MPYE-5-1/8-HF-010-B			153 006	QS-3/8-8				
351 ... 590	MPYE-5-1/4-010-B	153 007	QS-1/4-10	153 008	QS-3/8-10	152 588	PUN-10x1,5	2316	U-1/4
591 ... 735	MPYE-5-3/8-010-B	153 009	QS-3/8-12	153 009	QS-3/8-12	152 589	PUN-12x2	2309	U-3/8
<b>Ø 80 mm</b>									
80 ... 115	MPYE-5-1/8-LF-010-B	153 004	QS-1/8-8	153 006	QS-3/8-8	152 587	PUN-8x1,25	2307	U-1/8
116 ... 175	MPYE-5-1/8-HF-010-B			153 006	QS-3/8-8				
176 ... 440	MPYE-5-1/4-010-B	153 007	QS-1/4-10	153 008	QS-3/8-10	152 588	PUN-10x1,5	2316	U-1/4
441 ... 735	MPYE-5-3/8-010-B	153 009	QS-3/8-12	153 009	QS-3/8-12	152 589	PUN-12x2	2309	U-3/8

1) Fittings sold only in packs of 10.

2) 2 pieces are required.

# End position controllers SPC11

Technical data

FESTO

**Accessories for the solution package for DNC horizontally mounted**  
 For effective cylinder stroke 80 ...750 mm

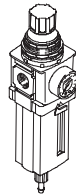
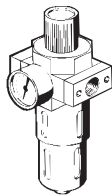

Ordering data									
Effective cylinder stroke DNC-... [mm]	Filter regulator, D series with filter cartridge 5 µm			Filter cartridge 5 µm D series		Filter regulator, MS series with filter cartridge 5 µm		Filter cartridge 5 µm MS series	
	Part No.	Type	Part No.	Type	Part No.	Type	Part No.	Type	
Ø 32 mm									
80 ... 735	162 719	LFR-¼-D-5M-MINI	159 640	LFP-D-MINI-5M	529 152	MS4-LFR-¼-D7-CRM-AS	534 501	MS4-LFP-C	
Ø 40 mm									
80 ... 440	162 719	LFR-¼-D-5M-MINI	159 640	LFP-D-MINI-5M	529 152	MS4-LFR-¼-D7-CRM-AS	534 501	MS4-LFP-C	
441 ... 735	162 721	LFR-⅜-D-5M-MIDI	159 594	LFP-D-MIDI-5M	529 204	MS6-LFR-¼-D7-CRM-AS	534 499	MS6-LFP-C	
Ø 50 mm									
80 ... 440	162 719	LFR-¼-D-5M-MINI	159 640	LFP-D-MINI-5M	529 152	MS4-LFR-¼-D7-CRM-AS	534 501	MS4-LFP-C	
441 ... 735	162 721	LFR-⅜-D-5M-MIDI	159 594	LFP-D-MIDI-5M	529 204	MS6-LFR-¼-D7-CRM-AS	534 499	MS6-LFP-C	
Ø 63 mm									
80 ... 350	162 719	LFR-¼-D-5M-MINI	159 640	LFP-D-MINI-5M	529 152	MS4-LFR-¼-D7-CRM-AS	534 501	MS4-LFP-C	
351 ... 590	162 721	LFR-⅜-D-5M-MIDI	159 594	LFP-D-MIDI-5M	529 204	MS6-LFR-¼-D7-CRM-AS	534 499	MS6-LFP-C	
591 ... 735	162 724	LFR-¾-D-5M-MAXI	159 641	LFP-D-MAXI-5M	529 224	MS6-LFR-⅜-D7-CRM-AS	534 499	MS6-LFP-C	
Ø 80 mm									
80 ... 175	162 719	LFR-¼-D-5M-MINI	159 640	LFP-D-MINI-5M	529 152	MS4-LFR-¼-D7-CRM-AS	534 501	MS4-LFP-C	
176 ... 440	162 721	LFR-⅜-D-5M-MIDI	159 594	LFP-D-MIDI-5M	529 204	MS6-LFR-¼-D7-CRM-AS	534 499	MS6-LFP-C	
441 ... 735	162 724	LFR-¾-D-5M-MAXI	159 641	LFP-D-MAXI-5M	529 224	MS6-LFR-⅜-D7-CRM-AS	534 499	MS6-LFP-C	

Servopneumatic positioning systems  
 Electronic end-position cushioning

1.4

# End position controllers SPC11

Technical data



## Order example

For pneumatic standard drive DNCl with integrated displacement encoder

A workpiece weighing 55 kg is to be moved horizontally on a loading station. The workpiece gripper

attached to the piston rod of the drive weighs 40 kg. The total weight to be moved is therefore 95 kg. The desired

travel distance is 300 mm. The travel time is to be < 1.5 seconds.

### Step 1: Selecting the cylinder stroke

For a travel distance of 300 mm, use the table on → 5 / 1.4-29 to select the next-largest standard stroke of 320 mm or the effective cylinder stroke of 320 mm. This column has a grey background.

### Step 2: Specifying the drive

For a total weight of 95 kg to be moved horizontally, there is a choice of piston diameters of 50 and 63 mm (see data for max. total weight to be moved).

For the purposes of our example, the drive DNCl-50-320-P-A, part no. 535 413 has been selected.

### Step 3: Specifying a proportional 5/3-way valve

The appropriate proportional 5/3-way valve is shown at the intersection of the grey column used in step 1 and the line for the selected pneumatic drive DNCl-50-... in the "Proportional 5/3-way valve" section of the table. For the purposes of our example, the proportional-5/3-way valve MPYE-5-1/8- HF-010B, part no. 151 693 has been selected.

### Step 4: Completing the order information

To order a complete system you must add the data for the end position controller, valve and controller cables and manual (if required). The complete ordering data for our example can be found on → 5 / 1.4-29. A manual should normally be ordered. If you already have one, leave the appropriate box blank, indicating that you do not want a manual.

### Step 5: Determining the travel time

To calculate the travel time use the "Smart Soft Stop" software tool. The travel time for the order example is 0.92 seconds.



Selection and ordering aid for Smart Soft Stop and ProDrive  
[www.festo.com/en/engineering](http://www.festo.com/en/engineering)

- Note

Remember when selecting the drive mounting components that some of these are not backlash-free and therefore cannot be used with the Smart Soft Stop system. The drives must be mounted directly.

- Note

Check that the loads placed on the drive by a gripper during movement do not exceed permissible limits. To carry out simulation quickly and easily, use the Smart Soft Stop software tool.

- Note

The self-aligning rod coupler FK is not backlash-free. It must not therefore be used in combination with standard cylinder DNCl.

Ordering data					
Pneumatic drive		Proportional 5/3-way valve		End position controller	
Part No.	Type	Part No.	Type	Part No.	Type
535 413	DNCl-50-320-P-A	151 693	MPYE-5-1/8-HF-010B	537 321	SPC11-INC
Valve cable		Controller cable			
Part No.	Type	Part No.	Type		
170 238	KMPYE-AIF-1-GS-GD-2	177 674	KMPV-SUB-D-15-10		

# End position controllers SPC11

Technical data

FESTO

Step 1 and 2:									
Standard cylinders/Type		DNCl-... <sup>1)</sup> -... <sup>2)</sup> -P-A							
Effective cylinder stroke (standard stroke)	[mm]	100	160	200	250	320	400	500	
	Max. overall mass to be moved horizontally by $\varnothing$	32	45 kg						
		40	75 kg						
		50	120 kg						
	63	180 kg							
Part No. for $\varnothing$	32	535 411							
	40	535 412							
	50	535 413							
	63	535 414							

Step 3:								
Proportional 5/3-way valves <sup>3)</sup>		1 = 151 692 MPYE-5-1/8-LF-010-B			3 = 151 694 MPYE-5-1/4-010-B			
Part No./Type		2 = 151 693 MPYE-5-1/8-HF-010-B						
Effective cylinder stroke (standard stroke)	[mm]	100	160	200	250	320	400	500
	Horizontal for $\varnothing$	32	1	1	1	1	1	2
		40	1	1	1	1	2	2
		50	1	1	1	1	2	3
	63	1	1	2	2	2	3	

Step 4:			
End position controllers and accessories	Part No.	Type	Brief description
End position controller	537 321	SPC11-INC	
Cable	Valve	170 238 KMPYE-AIF-1-GS-GD-2	Cable length 2 m
		170 239 KMPYE-AIF-1-GS-GD-0,3	Cable length 0.3 m
SPC11/PLC		177 673 KMPV-SUB-D-15-5	Cable length 5 m
		177 674 KMPV-SUB-D-15-10	Cable length 10 m

-  - Note  
Manuals → 5 / 1.4-43

- 1) Indicate piston  $\varnothing$ . Technical data and dimensions → 4.
- 2) Indicate calculated effective stroke of cylinder.
- 3) Technical data and dimensions → 5 / 1.5-2.

# End position controllers SPC11

Technical data



## Accessories for the solution package for DNCI horizontally mounted

For effective cylinder stroke 100 ... 500 mm

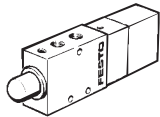
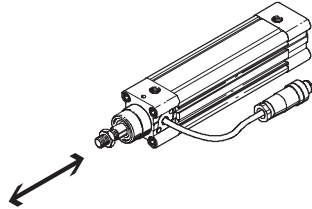

### Ordering data

Effective cylinder stroke DNCI-... [mm]	Proportional 5/3-way valve  Type	Fittings <sup>1)</sup>				Compressed air tubing		Silencer <sup>2)</sup>	
		For MPYE-5-...		DNCI		Part No.	Type	Part No.	Type
<b>Ø 32 mm</b>									
100 ... 400	MPYE-5-1/8-LF-010-B	153 004	QS-1/8-8	153 004	QS-1/8-8	152 587	PUN-8x1,25	2307	U-1/8
500	MPYE-5-1/8-HF-010-B								
<b>Ø 40 mm</b>									
100 ... 250	MPYE-5-1/8-LF-010-B	153 004	QS-1/8-8	153 005	QS-1/4-8	152 587	PUN-8x1,25	2307	U-1/8
320 ... 500	MPYE-5-1/8-HF-010-B			153 005	QS-1/4-8				
<b>Ø 50 mm</b>									
100 ... 250	MPYE-5-1/8-LF-010-B	153 004	QS-1/8-8	153 005	QS-1/4-8	152 587	PUN-8x1,25	2307	U-1/8
320 ... 400	MPYE-5-1/8-HF-010-B								
500	MPYE-5-1/4-010-B	153 007	QS-1/4-10	153 007	QS-1/4-10	152 588	PUN-10x1,5	2316	U-1/4
<b>Ø 63 mm</b>									
100 ... 160	MPYE-5-1/8-LF-010-B	153 004	QS-1/8-8	153 006	QS-3/8-8	152 587	PUN-8x1,25	2307	U-1/8
200 ... 320	MPYE-5-1/8-HF-010-B			153 006	QS-3/8-8				
400 ... 500	MPYE-5-1/4-010-B	153 007	QS-1/4-10	153 008	QS-3/8-10	152 588	PUN-10x1,5	2316	U-1/4

1) Fittings sold only in packs of 10.

2) 2 pieces are required.

# End position controllers SPC11

Technical data

FESTO

**Accessories for the solution package for DNCI horizontally mounted**  
 For effective cylinder stroke 100 ... 500 mm

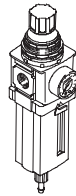
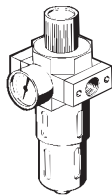

Ordering data									
Effective cylinder stroke DNCI-... [mm]	Filter regulator, D series with filter cartridge 5 µm			Filter cartridge 5 µm D series		Filter regulator, MS series with filter cartridge 5 µm		Filter cartridge 5 µm MS series	
	Part No.	Type		Part No.	Type	Part No.	Type	Part No.	Type
Ø 32 mm									
100 ... 500	162 719	LFR-¼-D-5M-MINI		159 640	LFP-D-MINI-5M		529 152	MS4-LFR-¼-D7-CRM-AS	534 501 MS4-LFP-C
Ø 40 mm									
100 ... 400	162 719	LFR-¼-D-5M-MINI		159 640	LFP-D-MINI-5M		529 152	MS4-LFR-¼-D7-CRM-AS	534 501 MS4-LFP-C
500	162 721	LFR-⅜-D-5M-MIDI		159 594	LFP-D-MIDI-5M		529 204	MS6-LFR-¼-D7-CRM-AS	534 499 MS6-LFP-C
Ø 50 mm									
100 ... 400	162 719	LFR-¼-D-5M-MINI		159 640	LFP-D-MINI-5M		529 152	MS4-LFR-¼-D7-CRM-AS	534 501 MS4-LFP-C
500	162 721	LFR-⅜-D-5M-MIDI		159 594	LFP-D-MIDI-5M		529 204	MS6-LFR-¼-D7-CRM-AS	534 499 MS6-LFP-C
Ø 63 mm									
100 ... 320	162 719	LFR-¼-D-5M-MINI		159 640	LFP-D-MINI-5M		529 152	MS4-LFR-¼-D7-CRM-AS	534 501 MS4-LFP-C
400 ... 500	162 721	LFR-⅜-D-5M-MIDI		159 594	LFP-D-MIDI-5M		529 204	MS6-LFR-¼-D7-CRM-AS	534 499 MS6-LFP-C

Servopneumatic positioning systems  
 Electronic end-position cushioning

1.4

# End position controllers SPC11

Technical data



## Order example

For the pneumatic drive DNCM with adapted displacement encoder LWH

A workpiece weighing 20 kg is to be moved horizontally on a handling station. An external guide is used to

accurately position the workpiece gripper which weighs 15 kg. The total weight is therefore 35 kg. The desired

travel distance is 180 mm. The travel time is to be < 1.0 seconds.

### Step 1: Selecting the cylinder stroke

For a travel distance of 180 mm, use the table on → 5 / 1.4-33 to select the next-largest standard stroke of 200 mm. This column has a grey background.

### Step 2: Specifying the drive

For a total weight of 35 kg to be moved horizontally, the piston diameter of 32 mm is selected. In the variant DNCM-...-FENG, the drive is equipped with a guide unit (with ball bearing guide) as well as the displacement encoder. The guide unit is mounted and tested at the factory. For the purposes of our example, the drive DNCM-32-200-P-POT2-FENG, part no. 528 940 has been selected.

### Step 3: Displacement encoder

The appropriate displacement encoder for the drive is mounted and tested at the factory.

### Step 4: Specifying a proportional 5/3-way valve

The appropriate proportional 5/3-way valve is shown at the intersection of the grey column used in step 1 and the line for the selected pneumatic drive DNCM-32-... in the "Proportional 5/3-way valve" section of the table. For the purposes of our example, the proportional-5/3-way valve MPYE-5-1/8-LF-010B, part no. 151 692 has been selected.

### Step 5: Completing the order information

To order a complete system you must add the data for the end position controller, valve and controller cables and manual (if required). The complete ordering data for our example can be found on → 5 / 1.4-33. A manual should normally be ordered. If you already have one, leave the appropriate box blank, indicating that you do not want a manual.

### Step 6: Determining the travel time

To calculate the travel time use the "Smart Soft Stop" software tool. The travel time for the order example is 0.69 seconds.



Selection and ordering aid for Smart Soft Stop and ProDrive  
[www.festo.com/en/engineering](http://www.festo.com/en/engineering)

 - Note

Remember when selecting the drive mounting components that some of these are not backlash-free and therefore cannot be used with the Smart Soft Stop system. The drives must be mounted directly.

 - Note

Check that the loads placed on the drive by a gripper during movement do not exceed permissible limits. To carry out simulation quickly and easily, use the Smart Soft Stop software tool.

 - Note

The self-aligning rod coupler FK is not backlash-free. It must not therefore be used in combination with standard cylinder DNCM.

Ordering data					
Pneumatic drive		Proportional 5/3-way valve		End position controller	
Part No.	Type	Part No.	Type	Part No.	Type
528 940	DNCM-32-200-P-POT2-FENG	151 692	MPYE-5-1/8-LF-010B	192 216	SPC11-POT-TLF

Valve cable		Controller cable	
Part No.	Type	Part No.	Type
170 238	KMPYE-AIF-1-GS-GD-2	177 674	KMPV-SUB-D-15-10



# End position controllers SPC11

Technical data

FESTO

Step 1:								
Standard cylinders/Type		DNCM-... <sup>1)</sup> ... <sup>2)</sup> .p-... <sup>3)</sup>						
Effective cylinder stroke (standard stroke)	[mm]	100	160	200	250	320	400	500
Max. overall mass to be moved horizontally/vertically by $\varnothing$	32	45/15 kg						
	50	120/40 kg						
Part No. for $\varnothing$	32	528 940						
	50	528 941						

## Step 2 and 3: → 5 / 1.4-35

Step 4:								
Proportional 5/3-way valves <sup>4)</sup>		1 = 151 692 MPYE-5-1/8-LF-010-B			3 = 151 694 MPYE-5-1/4-010-B			
Part No./Type		2 = 151 693 MPYE-5-1/8-HF-010-B						
Effective cylinder stroke (standard stroke)	[mm]	100	160	200	250	320	400	500
Horizontal/vertical for $\varnothing$	32	1/1	1/1	1/1	1/1	2/1	2/1	2/1
	50	1/1	1/1	1/1	2/1	2/1	2/2	3/3

Step 5:				
End position controllers and accessories		Part No.	Type	Brief description
End position controller	SPC11	<b>192 216</b>	<b>SPC11-POT-TLF</b>	
Cable	Valve	<b>170 238</b>	<b>KMPYE-AIF-1-GS-GD-2</b>	Cable length 2 m
		<b>170 239</b>	<b>KMPYE-AIF-1-GS-GD-0,3</b>	Cable length 0,3 m
	SPC11/PLC	<b>177 673</b>	<b>KMPV-SUB-D-15-5</b>	Cable length 5 m
		<b>177 674</b>	<b>KMPV-SUB-D-15-10</b>	Cable length 10 m

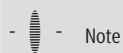

Note

Manuals → 5 / 1.4-43

- 1) Indicate piston  $\varnothing$ . Technical data and dimensions → 22.
- 2) Indicate calculated effective stroke of cylinder.
- 3) Design as per DNCM product modules.
- 4) Technical data and dimensions → 5 / 1.5-2.

# End position controllers SPC11

Technical data



## Arrangement of the displacement encoder

DNCM-...-POT1, potentiometer underneath

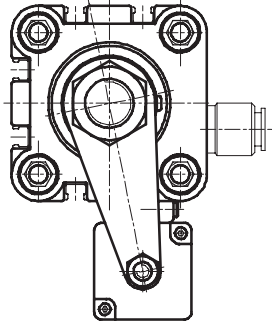

DNCM-...-POT2, potentiometer at rear

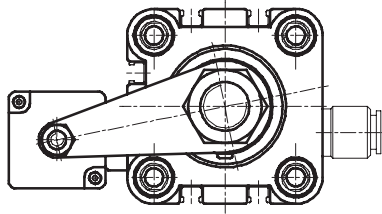

DNCM-...-POT3, potentiometer on top

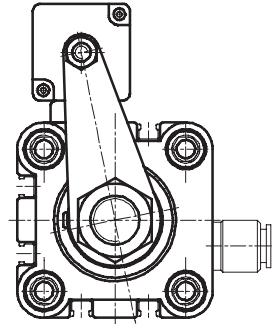

# End position controllers SPC11

Ordering data – Modular products



## Step 2 and 3:

M Mandatory data						O Options		
Module No.	Basic function	Size	Stroke	Cushioning	Encoder attachment position	Type of piston rod	Guide	Position sensing
528 940	DNCM	32	100	P	POT1 POT2 POT3	S2 S20	FENG	A
528 941		50	160					
			200					
			250					
			320					
			400					
		500						
<b>Order example</b>								
528 941	DNCM	- 50	- 500	- P	- POT3	- S20	-	- A

Ordering table							
Size		32	50	Condi- tions	Code	Enter code	
M	Module No.	528 940		528 941			
	Basic function	Standard cylinder with displacement encoder				DNCM	DNCM
	Size [mm]	32	50		-...		
	Stroke [mm]	100			-100		
		160			-160		
		200			-200		
		250			-250		
		320			[1] -320		
		400			[1] -400		
	500			[1] -500			
	Cushioning	Flexible cushioning rings/pads at both ends				-P	-P
	Encoder attachment position	Encoder underneath				-POT1	
		Encoder at rear				-POT2	
		Encoder on top				-POT3	
O	Type of piston rod	Through piston rod				[1] -S2	
		Through, hollow piston rod				[1] -S20	
	Guide	Guide unit with ball bearing guide KF				[2] -FENG	
	Position sensing	For proximity sensor				-A	

[1] 320, 400, 500, S2, S20  
Not with guide FENG.

[2] FENG Only with POT2 encoder.

### Transfer order code

# End position controllers SPC11

Technical data



## Accessories for the solution package for DNCM horizontally mounted

For effective cylinder stroke 100 ... 500 mm

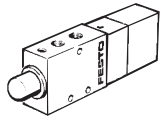
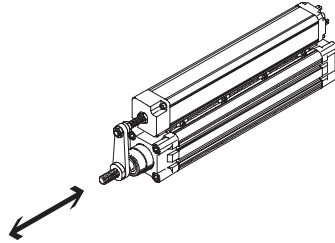

Ordering data									
Effective cylinder stroke DNCM-... [mm]	Proportional 5/3-way valve  Type	Fittings <sup>1)</sup>				Compressed air tubing		Silencer <sup>2)</sup>	
		For MPYE-5-...		DNCM		Part No.	Type	Part No.	Type
Ø 32 mm									
100 ... 400	MPYE-5-1/8-LF-010-B	153 004	QS-1/8-8	153 004	QS-1/8-8	152 587	PUN-8x1,25	2307	U-1/8
500	MPYE-5-1/8-HF-010-B								
Ø 50 mm									
100 ... 250	MPYE-5-1/8-LF-010-B	153 004	QS-1/8-8	153 005	QS-1/4-8	152 587	PUN-8x1,25	2307	U-1/8
320 ... 400	MPYE-5-1/8-HF-010-B								
500	MPYE-5-1/4-010-B	153 007	QS-1/4-10	153 007	QS-1/4-10	152 588	PUN-10x1,5	2316	U-1/4

1) Fittings sold only in packs of 10.

2) 2 pieces are required.

# End position controllers SPC11

Technical data

FESTO

**Accessories for the solution package for DNCM horizontally mounted**  
 For effective cylinder stroke 100 ... 500 mm

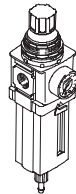
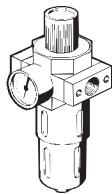

Ordering data								
Effective cylinder stroke DNCM-... [mm]	Filter regulator, D series with filter cartridge 5 µm		Filter cartridge 5 µm D series		Filter regulator, MS series with filter cartridge 5 µm		Filter cartridge 5 µm MS series	
	Part No.	Type	Part No.	Type	Part No.	Type	Part No.	Type
Ø 32 mm								
100 ... 500	162 719	LFR-¼-D-5M-MINI	159 640	LFP-D-MINI-5M	529 152	MS4-LFR-¼-D7-CRM-AS	534 501	MS4-LFP-C
Ø 50 mm								
100 ... 400	162 719	LFR-¼-D-5M-MINI	159 640	LFP-D-MINI-5M	529 152	MS4-LFR-¼-D7-CRM-AS	534 501	MS4-LFP-C
500	162 721	LFR-⅜-D-5M-MIDI	159 594	LFP-D-MIDI-5M	529 204	MS6-LFR-¼-D7-CRM-AS	534 499	MS6-LFP-C

Servopneumatic positioning systems  
 Electronic end-position cushioning

1.4

# End position controllers SPC11

Technical data



## Order example for swivel module DSMI

A workpiece with a mass moment of inertia of  $400 \text{ kgm}^2 \times 10^{-4}$  is to be moved on an unloading station. The workpiece gripper attached to the

shaft of the swivel module has a mass moment of inertia of  $230 \text{ kgm}^2 \times 10^{-4}$ . The total mass moment of inertia to be moved is therefore  $630 \text{ kgm}^2 \times 10^{-4}$ .

The swivel angle is  $250^\circ$ . The travel time is to be  $< 1$  second.



Selection and ordering aid for Smart Soft Stop and ProDrive  
[www.festo.com/en/engineering](http://www.festo.com/en/engineering)

### Step 1: Specifying the swivel angle

The maximum swivel angle of the swivel modules DSMI-25-270 and DSMI-40-270 is  $270^\circ$  and can be fully exploited. The integrated displacement encoder is appropriately designed.

### Step 2: Specifying the drive

DSMI-40-270 must be used for the total mass moment of inertia of  $630 \text{ kgm}^2 \times 10^{-4}$  to be moved horizontally  
 → 5 / 1.4-39.

### Step 3: Specifying a proportional 5/3-way valve

As can be seen from the table → 5 / 1.4-39, the proportional 5/3-way valve MPYE-5-1/8-LF-010B is generally required for swivel module DSMI-40-270.



Note  
 Remember when selecting the drive mounting components that some of these are not backlash-free and therefore cannot be used with the Smart Soft Stop system. The drives must be mounted directly.



Note  
 Check that the loads placed on the drive by a gripper during the movement process do not exceed permissible limits. To carry out simulation quickly and easily, use the Smart Soft Stop software tool.

### Step 4: Completing the order information

To order a complete system you must add the data for the end position controller, valve and controller cables and manual (if required). The complete ordering data for our example can be found on → 5 / 1.4-39. A manual should normally be ordered. If you already have one, leave the appropriate box blank, indicating an express waiver of a manual.

### Step 5: Determining the travel time

To calculate the travel time use the "Smart Soft Stop" software tool. The travel time for the order example is 0.89 seconds.

Ordering data					
Swivel module		Proportional 5/3-way valve		End position controller	
Part No.	Type	Part No.	Type	Part No.	Type
192 271	DSMI-40-270	151 692	MPYE-5-1/8-LF-010B	192 217	SPC11-POT-LWG

Valve cable		Controller cable	
Part No.	Type	Part No.	Type
170 238	KMPYE-AIF-1-GS-GD-2	177 674	KMPV-SUB-D-15-10

# End position controllers SPC11

Technical data

**FESTO**

Step 1 and 2:		
Swivel module with integrated displacement encoder	DSMI-25-270	DSMI-40-270
Swivel angle	270°	
Max. permissible mass moment of inertia, horizontal	300 kgm <sup>2</sup> x10 <sup>-4</sup>	1,200 kgm <sup>2</sup> x10 <sup>-4</sup>
Part No.	192 270	192 271

Step 3				
Proportional 5/3-way valves <sup>1)</sup>	Part No.	Type	Part No.	Type
	154 200	MPYE-5-M5-010B	151 692	MPYE-5-1/8-LF-010B

Step 4				
End position controllers and accessories		Part No.	Type	Brief description
End position controller	SPC11	192 217	SPC11-POT-LWG	
Cable	Valve	170 238	KMPYE-AIF-1-GS-GD-2	Cable length 2 m
		170 239	KMPYE-AIF-1-GS-GD-0,3	Cable length 0.3 m
	SPC11/PLC	177 673	KMPV-SUB-D-15-5	Cable length 5 m
		177 674	KMPV-SUB-D-15-10	Cable length 10 m

 Note  
Manuals → 5 / 1.4-43

1) Technical data and dimensions → 5 / 1.5-2.

# End position controllers SPC11

Technical data



## Accessories for the solution package for DSMI horizontally mounted

For swivel angle 0° ... 270°

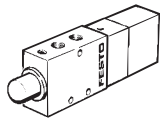
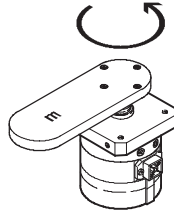

Ordering data									
Swivel angle DSMI	Proportional 5/3-way valve Type	Fittings <sup>1)</sup>				Compressed air tubing		Silencer <sup>2)</sup>	
		For MPYE-5-...		DSMI		Part No.	Type	Part No.	Type
		Part No.	Type	Part No.	Type	Part No.	Type	Part No.	Type
Ø 25 mm									
0° ... 270°	MPYE-5-M5-010-B	153 306	QSM-M5-6	153 306	QSM-M5-6	152 586	PUN-6x1	4645	U-M5
Ø 40 mm									
0° ... 270°	MPYE-5-1/8-LF-010-B	153 004	QS-1/8-8	153 004	QS-1/8-8	152 587	PUN-8x1,25	2307	U-1/8

1) Fittings sold only in packs of 10.

2) 2 pieces are required.



# End position controllers SPC11

Technical data

FESTO

## Accessories for the solution package for DSMI horizontally mounted

For swivel angle 0° ... 270°

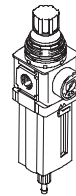
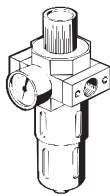

Ordering data								
Swivel angle DSMI	Filter regulator, D series with filter cartridge 5 µm		Filter cartridge 5 µm D series		Filter regulator, MS series with filter cartridge 5 µm		Filter cartridge 5 µm MS series	
	Part No.	Type	Part No.	Type	Part No.	Type	Part No.	Type
∅ 25 mm								
0° ... 270°	162 719	LFR-¼-D-5M-MINI	159 640	LFP-D-MINI-5M	529 152	MS4-LFR-¼-D7-CRM-AS	534 501	MS4-LFP-C
∅ 40 mm								
0° ... 270°	162 719	LFR-¼-D-5M-MINI	159 640	LFP-D-MINI-5M	529 152	MS4-LFR-¼-D7-CRM-AS	534 501	MS4-LFP-C

# End position controllers SPC11

Technical data



## Mass moment of inertia calculation with the aid of Festo software

Software tool: Mass moment of inertia

Servopneumatic positioning systems  
Electronic end-position cushioning

1.4



No matter whether you have discs, blocks, push-on flanges, grippers, etc: This tool does the job of calculating all mass moments of inertia for you.

Just save, send, or print – and you're finished.

Mass moment of inertia software tool  
[www.festo.com/en/engineering](http://www.festo.com/en/engineering)

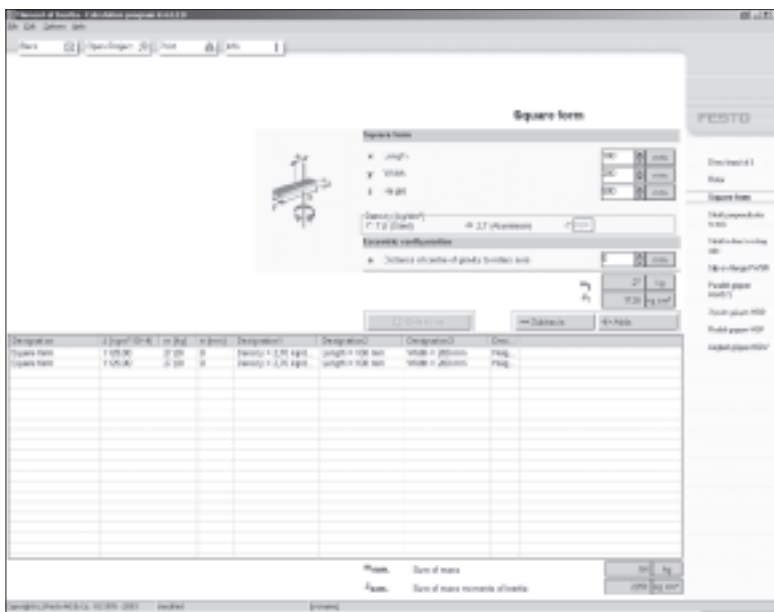

# End position controllers SPC11

Technical data

**FESTO**

Ordering data – Manuals							
Part No.			Type	Part No.			Type
System description – End position controllers							
SPC11	German	196 723	P.BE-SPC11-SYS-DE				
	English	196 724	P.BE-SPC11-SYS-EN				
	French	196 727	P.BE-SPC11-SYS-FR				
	Italian	196 726	P.BE-SPC11-SYS-IT				
	Swedish	196 728	P.BE-SPC11-SYS-SV				
	Spanish	196 725	P.BE-SPC11-SYS-ES				
Drive-specific supplement							
For DGCI				For DGP/DGPL/DGPI/DGPIL			
SPC11	German	549 166	P.BE-SPC11-DGCI-DE	SPC11	German	196 729	P.BE-SPC11-DGP-DE
	English	549 167	P.BE-SPC11-DGCI-EN		English	196 730	P.BE-SPC11-DGP-EN
	French	549 169	P.BE-SPC11-DGCI-FR		French	196 733	P.BE-SPC11-DGP-FR
	Italian	549 170	P.BE-SPC11-DGCI-IT		Italian	196 732	P.BE-SPC11-DGP-IT
	Swedish	549 171	P.BE-SPC11-DGCI-SV		Swedish	196 734	P.BE-SPC11-DGP-SV
	Spanish	549 168	P.BE-SPC11-DGCI-ES		Spanish	196 731	P.BE-SPC11-DGP-ES
For DNC				For DNCI			
SPC11	German	196 735	P.BE-SPC11-DNC-DE	SPC11	German	539 888	P.BE-SPC11-DNCI-DE
	English	196 736	P.BE-SPC11-DNC-EN		English	539 889	P.BE-SPC11-DNCI-EN
	French	196 739	P.BE-SPC11-DNC-FR		French	539 891	P.BE-SPC11-DNCI-FR
	Italian	196 738	P.BE-SPC11-DNC-IT		Italian	539 892	P.BE-SPC11-DNCI-IT
	Swedish	196 740	P.BE-SPC11-DNC-SV		Swedish	539 893	P.BE-SPC11-DNCI-SV
	Spanish	196 737	P.BE-SPC11-DNC-ES		Spanish	539 890	P.BE-SPC11-DNCI-ES
For DNCM				For DSMI			
SPC11	German	532 790	P.BE-SPC11-DNCM-DE	SPC11	German	196 741	P.BE-SPC11-DSMI-DE
	English	532 791	P.BE-SPC11-DNCM-EN		English	196 742	P.BE-SPC11-DSMI-EN
	French	532 794	P.BE-SPC11-DNCM-FR		French	196 745	P.BE-SPC11-DSMI-FR
	Italian	532 793	P.BE-SPC11-DNCM-IT		Italian	196 744	P.BE-SPC11-DSMI-IT
	Swedish	532 795	P.BE-SPC11-DNCM-SV		Swedish	196 746	P.BE-SPC11-DSMI-SV
	Spanish	532 792	P.BE-SPC11-DNCM-ES		Spanish	196 743	P.BE-SPC11-DSMI-ES

Servopneumatic positioning systems  
Electronic end-position cushioning

1.4

# End position controllers SPC11

Technical data



## Converting existing systems

<p><b>What are the points to note when converting existing systems that use the pneumatic drives DGP/DGPL or DNC?</b></p>	<p>Optimum system behaviour is guaranteed by Festo's uniquely specified solution packages, in which</p>	<p>all components are harmonised. When converting existing systems, observe the following points:</p>
<p><b>Where could system behaviour possibly change when an existing system is converted?</b></p>	<p>In normal cases, the entire cylinder stroke is used, including the internal</p>	<p>cushioning length (PPV); no stroke reserve is available.</p>
<p><b>What should be noted when installing the pneumatics?</b></p>	<ul style="list-style-type: none"> <li>• Make sure that the system configuration is symmetrical, i.e. that the tubing used to connect the compressed air supply to each end of the cylinder is of identical length.</li> </ul>	<ul style="list-style-type: none"> <li>• No flow controls between the valve and cylinder.</li> <li>• Open the end-position cushioning (PPV) 100%.</li> </ul>
<p><b>What should be noted when installing the electrics?</b></p>	<p>As far as the electrical actuation is concerned, the Smart Soft Stop system behaves like a standard pneumatic</p>	<p>system with a double solenoid valve and two proximity sensors.</p> <p>For further information see the manual System description: SPC11-... → 5 / 1.4-43.</p>
<p><b>Does the control program need to be adapted?</b></p>	<p>Existing systems which have provision for two digital inputs/outputs can be</p>	<p>converted without adaptation of the control program.</p>
<p><b>What proportional 5/3-way valve should be selected for the conversion project?</b></p>	<p>Exactly the same valve as specified in the solution packages on → 5 / 1.4-19 or 5 / 1.4-25.</p>	

**What end position controller is suitable for each drive or displacement encoder?**

End position controller	Drive	Displacement encoder
SPC11-POT-TLF	DGP/DGPL	MLO-POT-...-TLF
	DNCM	Adapted
SPC11-POT-LWG	DNC	MLO-POT-...-LWG
	DSMI	Integrated
SPC11-MTS-AIF	DGP/DGPL	MME-MTS-...-AIF
	DGPI/DGPIL	Integrated
SPC11-INC	DNCI	Integrated
SPC11-MTS-AIF-2	DGCI	Adapted