



- High dynamics
- Final control element for closed control loops
- 5/3 –way function

Proportional directional control valves MPYE

Key features

FESTO

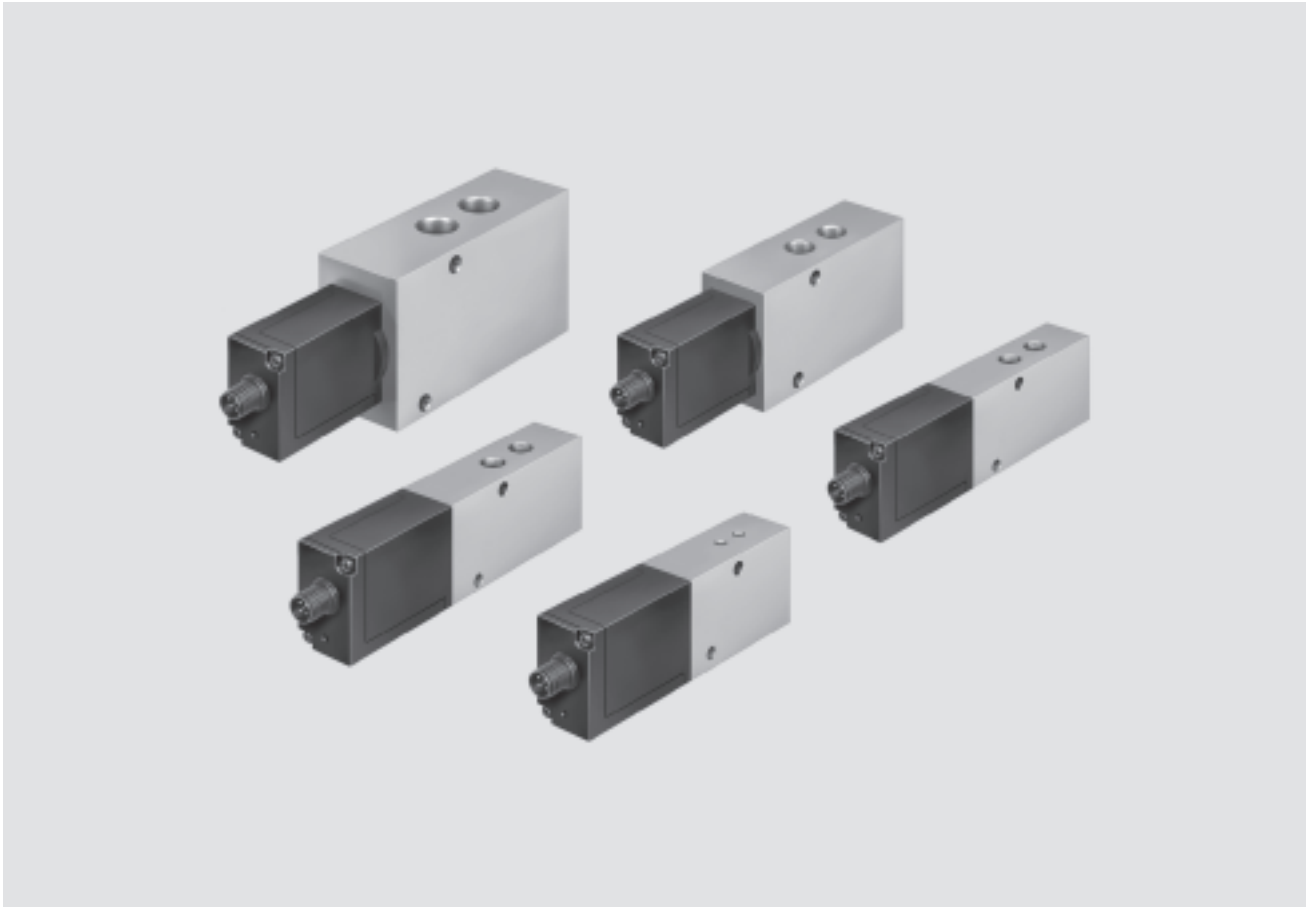

1.5

General information

- The directly actuated proportional directional control valve has a position-controlled spool. This transforms an analogue input signal into a corresponding opening cross-section at the valve outputs.
- In combination with an external position controller and displacement encoder, a precise pneumatic positioning system can be created.
- Flow control function for varying cylinder speed
- 5/3-way function for varying the direction of movement

Wide choice of variants

- Setpoint value input
 - Analogue voltage signal
 - Analogue current signal
- Flow rates from 100 ... 2 000 l/min

Proportional directional control valves MPYE

Key features and type codes

Short machine cycle times – fast switching of programmed flow rates

- Reduce machine cycle times by optimising cylinder speeds
 - Assembly technology
 - Handling technology
 - Furniture industry
- A: Proportional valves allow different speed levels and speed ramps to be set.
- B: Speed regulation with directional control valves is more difficult and is performed by means of exhaust air flow control.

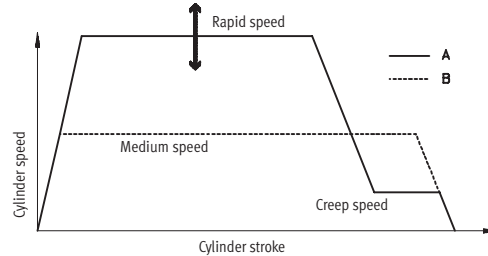

Flexible cylinder speeds – Achieving variable flow rates

- Flexibly adapting cylinder speeds to the process. Traversing individual acceleration ramps (gentle approach with delicate goods)
 - Automobile suppliers
 - Production technology
 - Conveyor technology
 - Test engineering

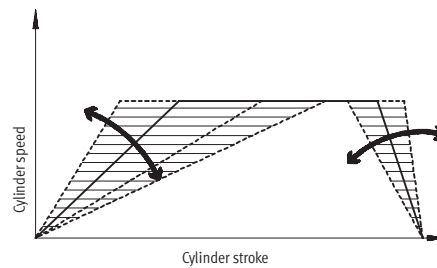

Proportional directional control valve as final control element – Dynamic and fast changing of flow rates

- Fatigue tests
- Pneumatic positioning with SPC200
- SoftStop with end-position controller SPC11

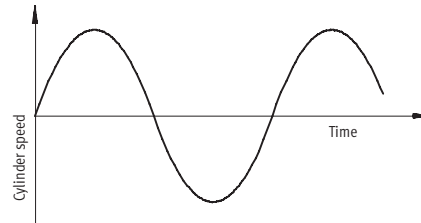

Type codes

MPYE – 5 – 1/8 LF – 010 – B

Type	
MPYE	Proportional directional control valve
Valve function	
5	5/3-way valve
Pneumatic connection	
M5	M5
1/8 LF	G1/8 Low Flow
1/8 HF	G1/8 High Flow
1/4	G1/4
3/8	G3/8
Setpoint value input	
010	Analogue voltage signal
420	Analogue current signal
Generation	
B	B series

Proportional directional control valves MPYE

Peripherals overview

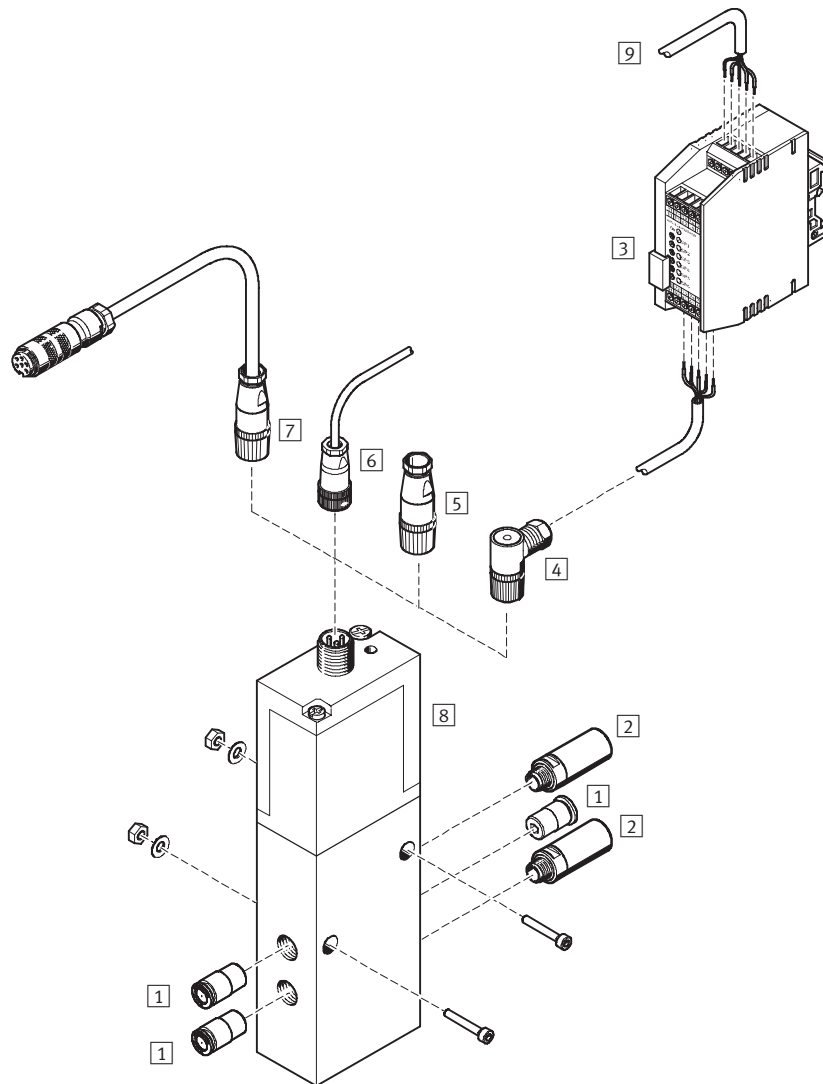

Accessories		
	Brief description	→ Page
1	Push-in fitting QS	Volume 3
2	Silencer	Volume 3
3	Setpoint module MPZ	5 / 1.5-8
4	Sensor socket SIE-WD-TR	5 / 1.5-10
5	Sensor socket SIE-GD	5 / 1.5-10
6	Connecting cable KMPYE	5 / 1.5-10
7	Connecting cable KVIA-MPYE	5 / 1.5-10
8	Proportional directional control valve MPYE	5 / 1.5-5
9	Digital input/output	-

Proportional directional control valves MPYE

Technical data

Function

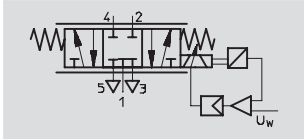

Variants

- Setpoint value input as analogue voltage signal 0 ... 10 V
- Setpoint value input as analogue current signal 4 ... 20 mA



- Voltage
17 ... 30 V DC
- Flow rate
100 ... 2 000 l/min
- Pressure
0 ... 10 bar

General technical data					
Pneumatic connection	M5	G $\frac{1}{8}$		G $\frac{1}{4}$	G $\frac{3}{8}$
		Low flow	High flow		
Valve function	5/3-way, normally closed				
Constructional design	Piston spool, directly actuated, controlled piston spool position				
Sealing principle	Hard				
Actuation type	Electrical				
Type of reset	Mechanical spring				
Type of pilot control	Direct				
Direction of flow	Non-reversible				
Type of mounting	Via through-holes				
Mounting position ¹⁾	Any				
Operating medium	Compressed air, filtered (to 5 μ m), unlubricated				
Nominal size [mm]	2	4	6	8	10
Standard nominal flow rate [l/min]	100	350	700	1 400	2 000
Product weight [g]	290	330	330	530	740

1) If the proportional directional control valve is in motion during operation, it must be mounted at right angles to the direction of movement.

Flow rate q at 6 \rightarrow 5 bar as a function of the setpoint voltage U

Voltage type MPYE-5-...-010-B

Current type MPYE-5-...-420-B

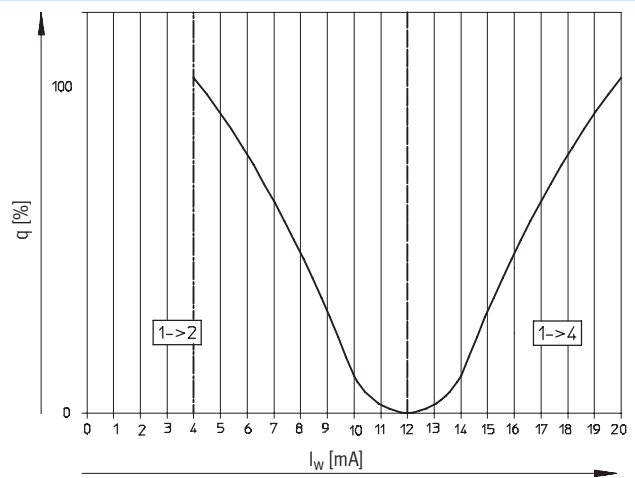
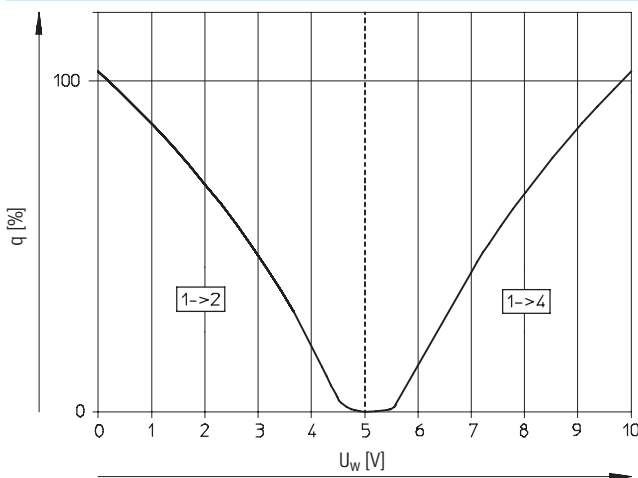

Proportional directional control valves MPYE

Technical data



Electrical data		M5	G1/8 Low flow	High flow	G1/4	G3/8	
Pneumatic connection							
Power supply	[V DC]	17 ... 30					
Max. current consumption	in mid-position	[mA]	100				
	at full stroke	[mA]	1 100				
Setpoint value	Voltage type	[V DC]	0 ... 10				
	Current type	[mA]	4 ... 20				
Max. hysteresis ¹⁾		[%]	0.4				
Valve mid-position	Voltage type	[V DC]	5 (±0.1)				
	Current type	[mA]	12 (±0.16)				
Duty cycle ²⁾		[%]	100				
Critical frequency ³⁾		[Hz]	125	100	100	90	65
Safety setting	Active mid-position in the event of setpoint value cable break						
Protection against polarity reversal	Voltage type	For all electrical connections					
	Current type	For setpoint value					
Protection class	IP65						
Electrical connection	4-pin plug socket, round design, M12x1						

- 1) Referred to the maximum stroke of the piston spool.
- 2) The proportional direction control valve automatically switches off if it overheats (goes to mid-position) and switches back on once it cools down.
- 3) Corresponds to the 3dB frequency at the maximum movement stroke of the piston spool.

Operating and environmental conditions	
Operating pressure	[bar] 0 ... 10
Ambient temperature	[°C] 0 ... 50
Vibration resistance ¹⁾	To DIN/IEC 68 Parts 2 -6, severity level 2
Continuous shock resistance ¹⁾	To DIN/IEC 68 Parts 2 -27, severity level 2
CE symbol	To 89/336/EEC (EMC regulation)
Temperature of medium	[°C] 5 ... 40, condensation not permitted

- 1) If the proportional directional control valve is in motion during operation, it must be mounted at right angles to the direction of movement.

Materials

Sectional view

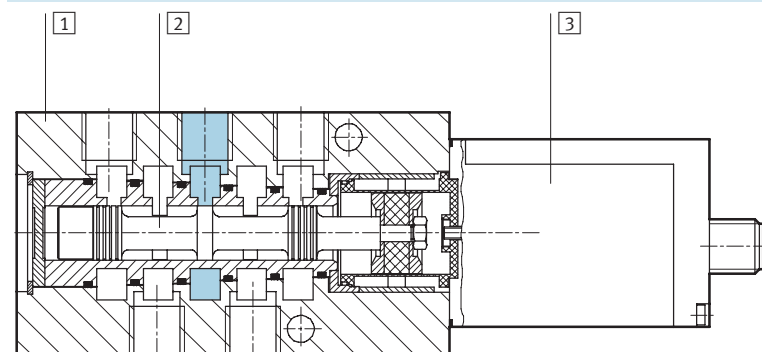

1	Housing	Anodised aluminium
2	Valve spool	Tempered aluminium
3	Housing for electronics	Galvanised acrylic butadiene styrene
-	Seals	Nitrile rubber

Proportional directional control valves MPYE

Technical data

FESTO

Dimensions

Download CAD data → www.festo.com/en/engineering

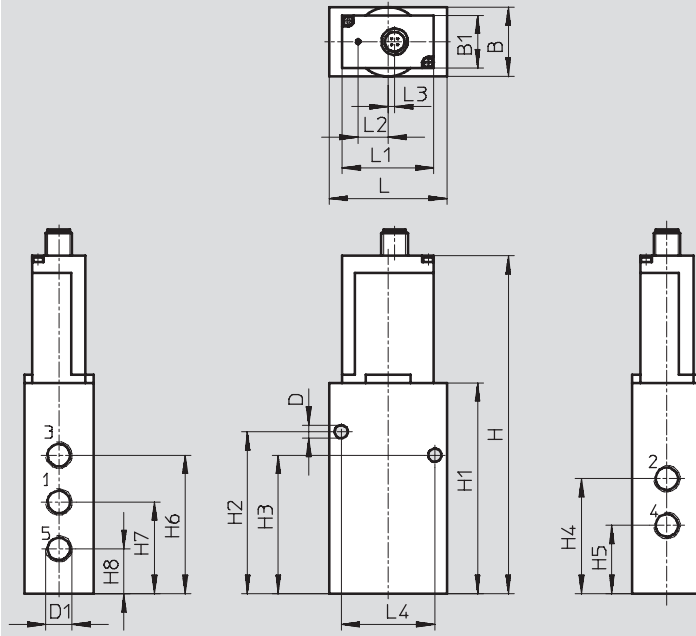

Pneumatic connection D1	B	B1	D ∅	H	H1	H2	H3	H4
M5	26	-	5.5	129.9	69	56.1	38.1	32.1
G $\frac{1}{8}$	26	-	5.5	149.3	88.4	71.3	55.1	45.8
G $\frac{1}{4}$	35	26	6.5	164.6	103.7	79.6	68.1	56.6
G $\frac{3}{8}$	40	26	6.5	176.6	115.7	98.4	79.4	65.4

Pneumatic connection D1	H5	H6	H7	H8	L	L1	L2	L3	L4
M5	20.1	38.1	26.1	14.1	45	-	14.8	3.2	32
G $\frac{1}{8}$	26.8	55.3	36.3	17.3	45	-	14.8	3.2	35
G $\frac{1}{4}$	33.6	68.1	45.1	22.1	58	45	14.8	3.2	46
G $\frac{3}{8}$	37.4	82.4	51.4	20.4	67	45	14.8	3.2	54

Terminal allocation

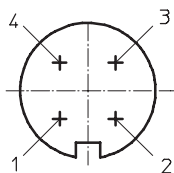

- 1 24 V DC, supply voltage
- 2 GND
- 3 U_w/I_w setpoint input
- 4 GND

Ordering data

Pneumatic connection	Voltage type 0 ... 10 mV		Current type 4 ... 20 mA	
	Part No.	Type	Part No.	Type
M5	154 200	MPYE-5-M5-010-B	162 959	MPYE-5-M5-420-B
G $\frac{1}{8}$	151 692	MPYE-5- $\frac{1}{8}$ LF-010-B	161 978	MPYE-5- $\frac{1}{8}$ LF-420-B
	151 693	MPYE-5- $\frac{1}{8}$ HF-010-B	161 979	MPYE-5- $\frac{1}{8}$ HF-420-B
G $\frac{1}{4}$	151 694	MPYE-5- $\frac{1}{4}$ -010-B	161 980	MPYE-5- $\frac{1}{4}$ -420-B
G $\frac{3}{8}$	151 695	MPYE-5- $\frac{3}{8}$ -010-B	161 981	MPYE-5- $\frac{3}{8}$ -420-B

Proportional directional control valves MPYE

Accessories



Setpoint module MPZ

 Voltage
20 ... 30 V DC

Function

- Generation of 6+1 analogue setpoint values for the proportional pressure regulators MPPE, MPPES and MPYE
- Digital controller
- Output voltage adjustable via spindle potentiometer



General technical data		
Mode of operation		Digital-analogue circuit with analogue output
Electrical connection		Screw terminal
Connection cross section	[mm ²]	2.5
Operating voltage range	[V DC]	20 ... 30
Adjustable output voltage	[V DC]	0 ... 10
Max. output current	[mA]	27
Power consumption at 24 V DC	[W]	1.5
Supply setpoint value adjustment	Voltage	[V] 10 ... 10.6
	Current	[mA] 6 ... 6.36
External setpoint input	Voltage	[V DC] 0 ... 10
	Potentiometer	[kΩ] 2.5 ... 10
Setpoint controller	Input resistance	[kΩ] 3
Residual ripple	[%]	Max. 10
Display	Ready	Green LED
	Setpoint active	Yellow LED
Type of mounting		On H-rail
Assembly position		Any
Product weight	[g]	80

Operating and environmental conditions		
Ambient temperature	[°C]	0 ... 60
Protection class		IP20
CE symbol (declaration of conformity)		In accordance with EU EMC directive
Corrosion resistance class CRC ¹⁾		2

1) Corrosion resistance class 2 according to Festo standard 940 070
Components requiring moderate corrosion resistance. Externally visible parts with primarily decorative surface requirements which are in direct contact with a normal industrial environment or media such as coolants or lubricating agents

Proportional directional control valves MPYE

Accessories



Connections and control elements

Connections			Priority
31	Activate setpoint 1	SP1	1 (highest)
32	Activate setpoint 2	SP2	2
33	Activate setpoint 3	SP3	3
34	Activate setpoint 4	SP4	4
35	Activate setpoint 5	SP5	5
11	Activate setpoint 6	SP6	6
13	Control line	0 V	-
21	Control line	0 V	-
22	External setpoint input	$U_{w, in} = 0 \dots 10 \text{ V DC}$	7 (lowest)
23	Control line	10 V DC	-
24	Screening	PE	-
41	Control line	0 V DC	-
42	Setpoint output	$U_{w, out}$	-
43	Power supply	-	-
45	Power supply	+	-

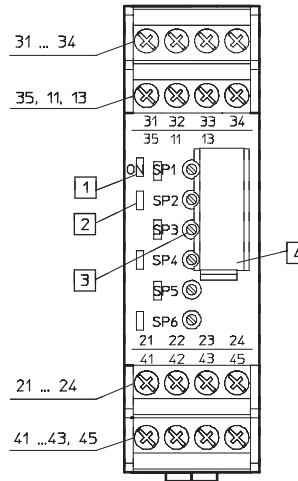

- 1 Operational status display, green LED
- 2 Setpoint display active (SP1 ... SP6), yellow LED
- 3 Setpoint potentiometer SP1 ... SP6
- 4 Inscription label

Dimensions

Download CAD data → www.festo.com/en/engineering

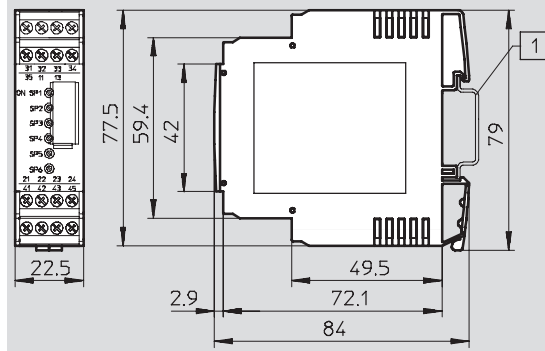

- 1 H-rail to DIN EN 60715







Ordering data

	Description	Part No.	Type
	Setpoint module for generating 6 + 1 analogue voltage signals	546 224	MPZ-1-24DC-SGH-6-SW

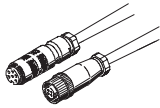
Proportional directional control valves MPYE

Accessories



Ordering data				
	Description	Cable length [m]	Part No.	Type
Connecting cable				Technical data → Volume 4
	Screened	5	151 909	KMPYE-5
		X length ¹⁾	151 910	KMPYE-...
	Connecting cable to the analogue module of valve terminal type 03	5	161 984	KVIA-MPYE-5
		10	161 985	KVIA-MPYE-10
	Connecting cable to the axis interface of the axis controller SPC200	0.3	170 239	KMPYE-AIF-1-GS-GD-0,3
		2	170 238	KMPYE-AIF-1-GS-GD-2
Sensor socket				Technical data → LEERER MERKER
	Straight, 4-pin, M12x1	-	18 494	SIE-GD
Sensor socket				Technical data → LEERER MERKER
	Angled, 4-pin, M12x1	-	12 956	SIE-WD-TR
Push-in fitting				Technical data → Volume 3
	For connecting compressed air tubing with standard external diameters			
Silencer				Technical data → Volume 3
	For fitting in exhaust ports			
Reducing nipple				Technical data → Volume 3
	-			

1) Max. 10 m