

Parallel grippers HGPC

FESTO

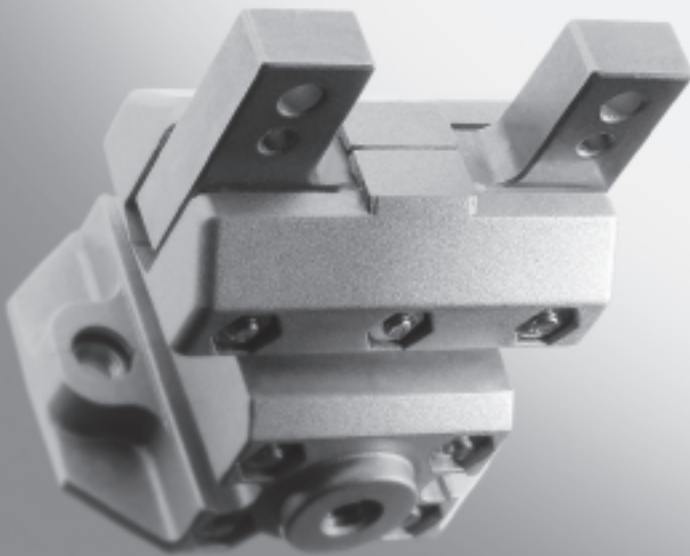

- Low cost
- Compact
- Reliable thanks to gripping force retention

Parallel grippers HGPC

Key features



At a glance

General

The compact and low-cost parallel gripper consists of a two-part symmetrical housing. The piston moves traverse to the half-shell casing in an optimum housing design that

guarantees reliable operation, long service life and convenient sensing. The gripper jaws move along the half shells in backlash-free, preloaded ball bearing guides.

- Double-acting gripper
- Compression spring for supplementary or retaining gripping forces
- Internal fixed flow control, does away with the need for external flow control in 80% of applications
- High force with minimal volume

- Suitable for external and internal gripping
- Wide range of options for attaching drive units
- Repetition accuracy of 0.05 mm
- Slot for proximity sensor SME/SMT-10



Gripper selection software
www.festo.com/en/engineering

Details

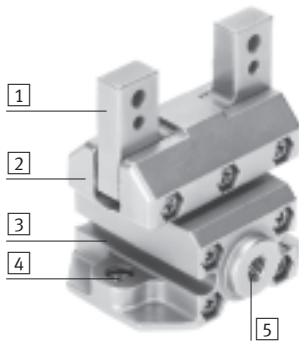

- 1 Gripper jaw with ball bearing guide
- 2 Housing based on half-shell principle
- 3 Slot for proximity sensor, for sensing the piston position
- 4 Mounting option
- 5 Supply port

Mounting option

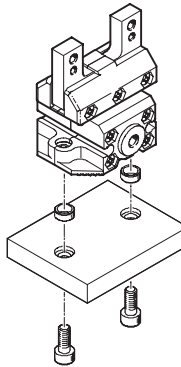

from above

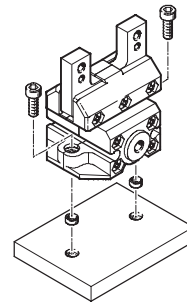

Note

Parallel grippers are not designed for the following applications:

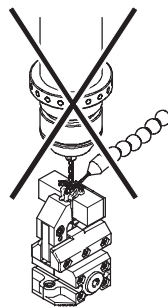

- Machining
- Aggressive media

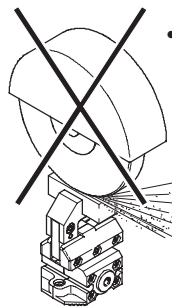

- Grinding dust

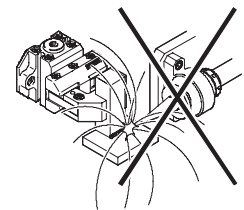

- Welding spatter

Parallel grippers HGPC

Peripherals overview and type codes

Peripherals overview

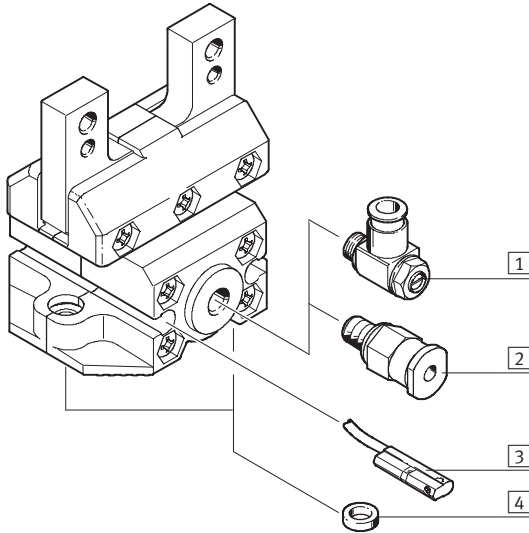

System product for handling and assembly technology

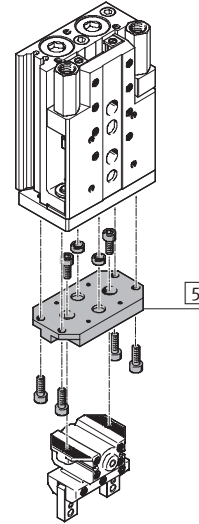

Accessories			
Type	Brief description	→ Page	
1 One-way flow control valve GRLA	For speed regulation	Volume 2	
2 Push-in fitting QS	For connecting compressed air tubing with standard external diameters	Volume 3	
3 Proximity sensor SME/SMT-10	For sensing the piston position	1 / 7.7-12	
4 Centring sleeve ZBH	For centring when attaching to a drive	1 / 7.7-12	
5 -	Drive/gripper connections	Volume 5	

Type codes

HGPC		-	12	-	A	-	G2
Type							
HGPC	Parallel gripper						
Size							
Position sensing							
A	For proximity sensing						
Gripping force retention							
G2	Closed						



Parallel grippers HGPC

Technical data

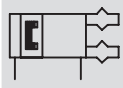

Function
Double-acting
HGPC-...-A



-  - Size
12, 16, 20 mm
-  - Stroke
6 ... 14 mm



Single-acting or
with gripping force retention
closed HGPC-...-G2



General technical data			
Size	12	16	20
Constructional design	Wedge-shaped drive Guided motion sequence		
Mode of operation	Double-acting		
Gripper function	Parallel		
Number of gripper jaws	2		
Max. applied load per external gripper finger ¹⁾ [N]	0.2	0.5	0.8
Stroke per gripper jaw [mm]	3	5	7
Pneumatic connection	M5		
Repetition accuracy ²⁾ [mm]	≤ 0.05		
Max. interchangeability [mm]	≤ 0.2		
Max. gripper jaw backlash ³⁾ [mm]	0		
Max. gripper jaw angular backlash ⁴⁾ [°]	0		
Max. operating frequency [Hz]	4		
Rotational symmetry [mm]	< Ø 0.2		
Position sensing	For proximity sensing		
Type of mounting	With female thread and centring sleeve		
Mounting position	Any		

- 1) Valid for unthrottled operation
- 2) End-position drift under constant conditions of use with 100 consecutive strokes in the direction of movement of the gripper jaws
- 3) Perpendicular to the direction of motion of the gripper jaws
- 4) Pretensioned, backlash-free ball bearing guide

Operating and environmental conditions			
Min. operating pressure	HGPC-...-A	[bar]	2
	HGPC-...-G2	[bar]	4
Max. operating pressure		[bar]	8
Operating medium	Filtered compressed air, lubricated or unlubricated		
Ambient temperature ¹⁾		[°C]	+5 ... +60
Corrosion resistance class CRC ²⁾	2		

- 1) Note operating range of proximity sensors
- 2) Corrosion resistance class 2 according to Festo standard 940 070
Components requiring moderate corrosion resistance. Externally visible parts with primarily decorative surface requirements which are in direct contact with a normal industrial environment or media such as coolants or lubricating agents

Weights [g]			
Size	12	16	20
HGPC-...-A	152	241	473
HGPC-...-G2	154	244	477

Parallel grippers HGPC

Technical data

FESTO

Materials

Sectional view

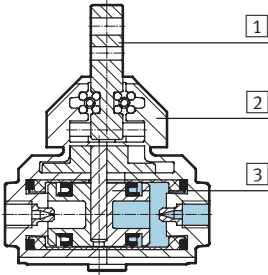

Parallel gripper		
1	Gripper jaw	High-alloy steel
2	Housing	Die-cast zinc
3	Piston	Polyamide
-	Seals	Polyurethane, nitrile rubber
Note on materials		Copper, PTFE and silicone-free

Gripping force [N] at 6 bar

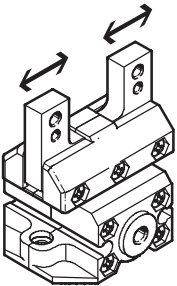

Size	12	16	20
Gripping force per gripper jaw			
Opening	22	41.5	63
Closing	22	41.5	63
Total gripping force			
Opening	44	83	126
Closing	44	83	126

Static characteristic load values at the gripper jaws

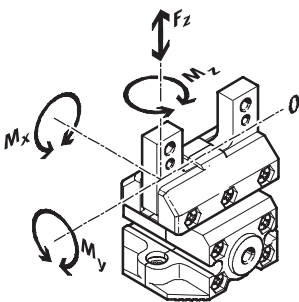

Indicated permissible forces and torques apply to a single gripper jaw. The indicated values include the lever arm, additional applied loads caused by the workpiece or external gripper

fingers, as well as forces which occur during movement. The zero coordinate line (gripper finger guide) must be taken into consideration for the calculation of torques.

Size	12	16	20
Max. permissible force F_z	[N] 40	80	120
Max. permissible torque M_x	[Nm] 1	2,5	5
Max. permissible torque M_y	[Nm] 1	2,5	5
Max. permissible torque M_z	[Nm] 1	2,5	5

Parallel grippers HGPC

Technical data

Mass moment of inertia [kgm²x10⁻⁴]

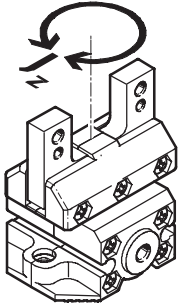

Mass moment of inertia [kgm²x10⁻⁴] of the parallel gripper in relation to the central axis with no load.

Size	12	16	20
HGPC-...-A	0.272	0.679	2.095
HGPC-...-G2	0.274	0.683	2.105

Opening and closing times [ms] at 6 bar

without external gripper fingers

with external gripper fingers

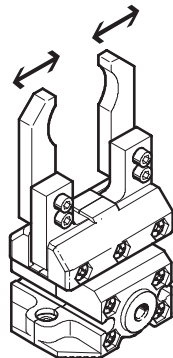
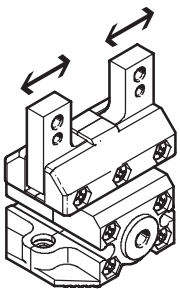

The indicated opening and closing times [ms] have been measured at room temperature and at 6 bar operating pressure with horizontally mounted gripper without additional

gripper fingers. The grippers must be throttled for greater applied loads. Opening and closing times must then be adjusted correspondingly.

Size		12	16	20
without external gripper fingers				
HGPC-...-A	Opening	30	60	90
	Closing	30	60	90
HGPC-...-G2	Opening	30	70	105
	Closing	30	50	75
with external gripper fingers as a function of applied load				
HGPC-...	0.4 N	40	-	-
	0.5 N	60	-	-
	0.6 N	80	-	-
	0.7 N	-	80	-
	1.0 N	-	100	-
	1.2 N	-	-	100

Parallel grippers HGPC

Technical data

FESTO

Gripping force F_{Grip} per gripper jaw as a function of operating pressure and lever arm x

Gripping forces as a function of the operating pressure and the lever arm can be determined for the size using the following graph.

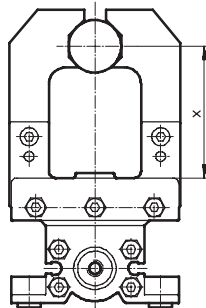

HGPC-12-A

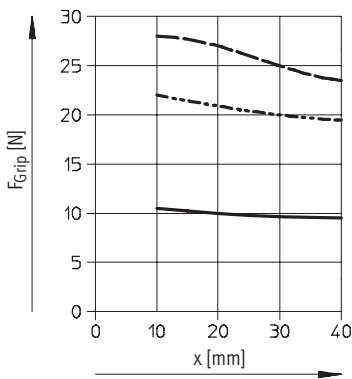

HGPC-16-A

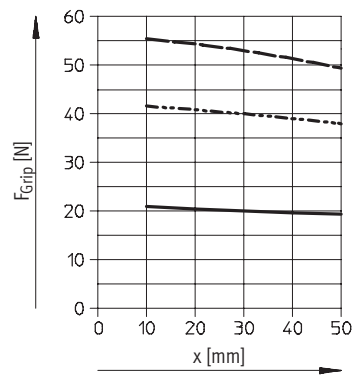

HGPC-20-A

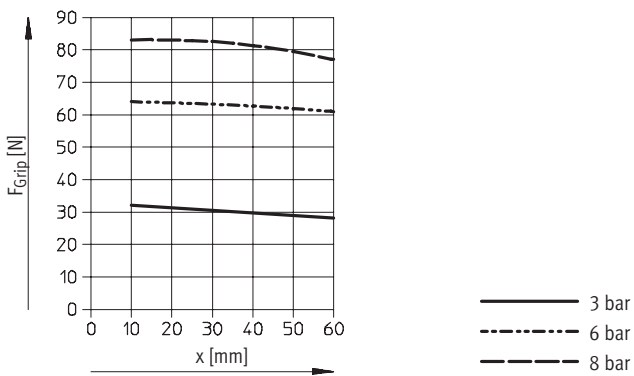

Parallel grippers HGPC

Technical data

Spring force F_S as a function of the gripper size and the overall stroke l

Gripping force retention for HGPC-...-G2

Spring forces F_S as a function of the gripper size and the overall stroke l for various gripper types (HGPC-...-G2) can be determined using the following graphs.

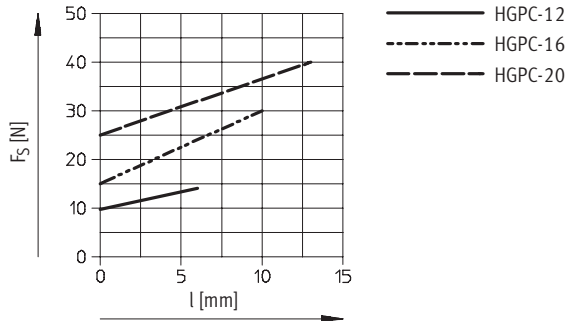
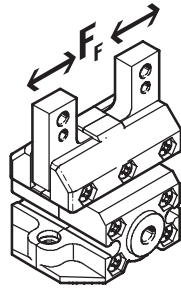

The lever arm x must be taken into consideration when determining the actual spring force F_{Stotal} . The formulae for calculating the spring force are provided in the table opposite.

Size	$F_{Stotal} =$
12	$-0.02 * x + 0.5 * F_S$
16	$-0.05 * x + 0.5 * F_S$
20	$-0.05 * x + 0.5 * F_S$

Determination of the actual gripping forces F_{Gr} for HGPC-...-G2 depending on the application

Parallel grippers with integrated spring type HGPC-...-G2 (closing gripping force retention) can be used as:

- single-acting grippers

- grippers with supplementary gripping force
- grippers with gripping force retention

In order to calculate available gripping forces F_{Gr} (per gripper jaw), the gripping force (F_{Grip}) and spring

force (F_{Stotal}) must be combined accordingly.

Application

Single-acting	Supplementary gripping force	Gripping force retention
<ul style="list-style-type: none"> • Gripping with spring force: $F_{Gr} = F_{Stotal}$ • Gripping with pressure force: $F_{Gr} = F_{Grip} - F_{Stotal}$ 	<ul style="list-style-type: none"> • Gripping with pressure and spring force: $F_{Gr} = F_{Grip} + F_{Stotal}$ 	<ul style="list-style-type: none"> • Gripping with spring force: $F_{Gr} = F_{Stotal}$

Parallel grippers HGPC

Technical data

Gripping force F_{Grip} per gripper jaw at 6 bar as a function of lever arm x and eccentricity y

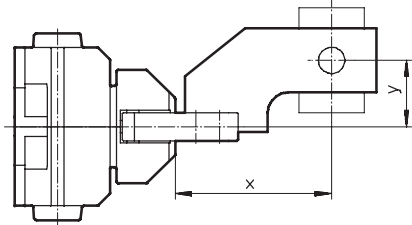

Gripping forces at 6 bar dependent upon eccentric application of force and the maximum permissible off-centre point of force application can be determined for the size using the following graph.

Calculation example

Given:

Lever arm $x = 20$ mm

Eccentricity $y = 22$ mm

To be found:

Gripping force at 6 bar

Procedure:

- Determine the intersection xy between lever arm x and eccentricity y in the graph for HGPC-12-A...
- Draw an arc (with centre at origin) through intersection xy .
- Determine the intersection between the arc and the X axis.
- Read the gripping force.

Result:

Gripping force $F =$ approx. 20.5 N

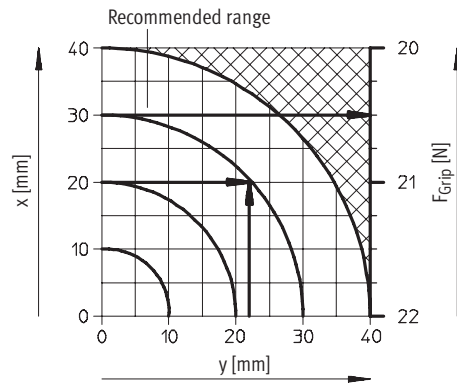

HGPC-12-A

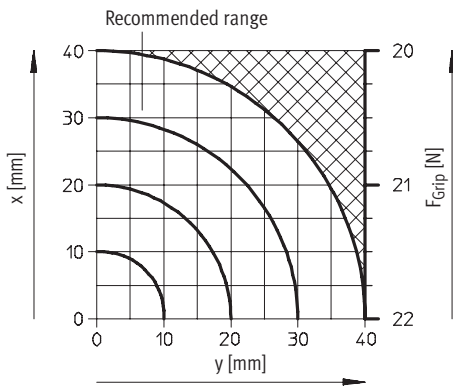

HGPC-16-A

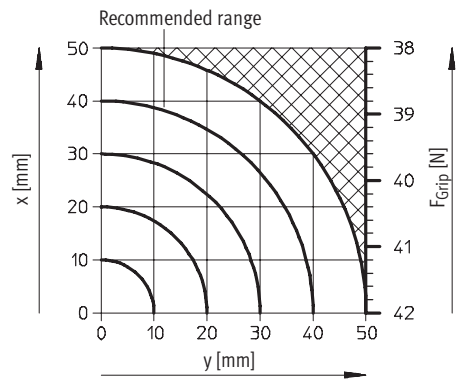

HGPC-20-A

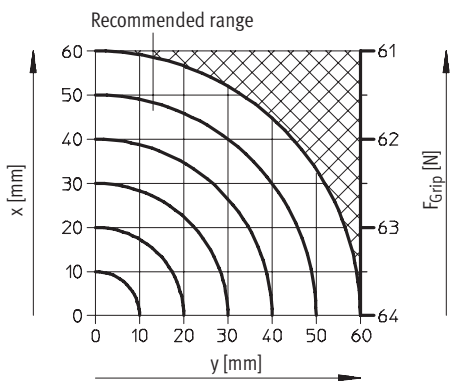

Parallel grippers HGPC

Technical data

Dimensions

Download CAD data → www.festo.com/en/engineering

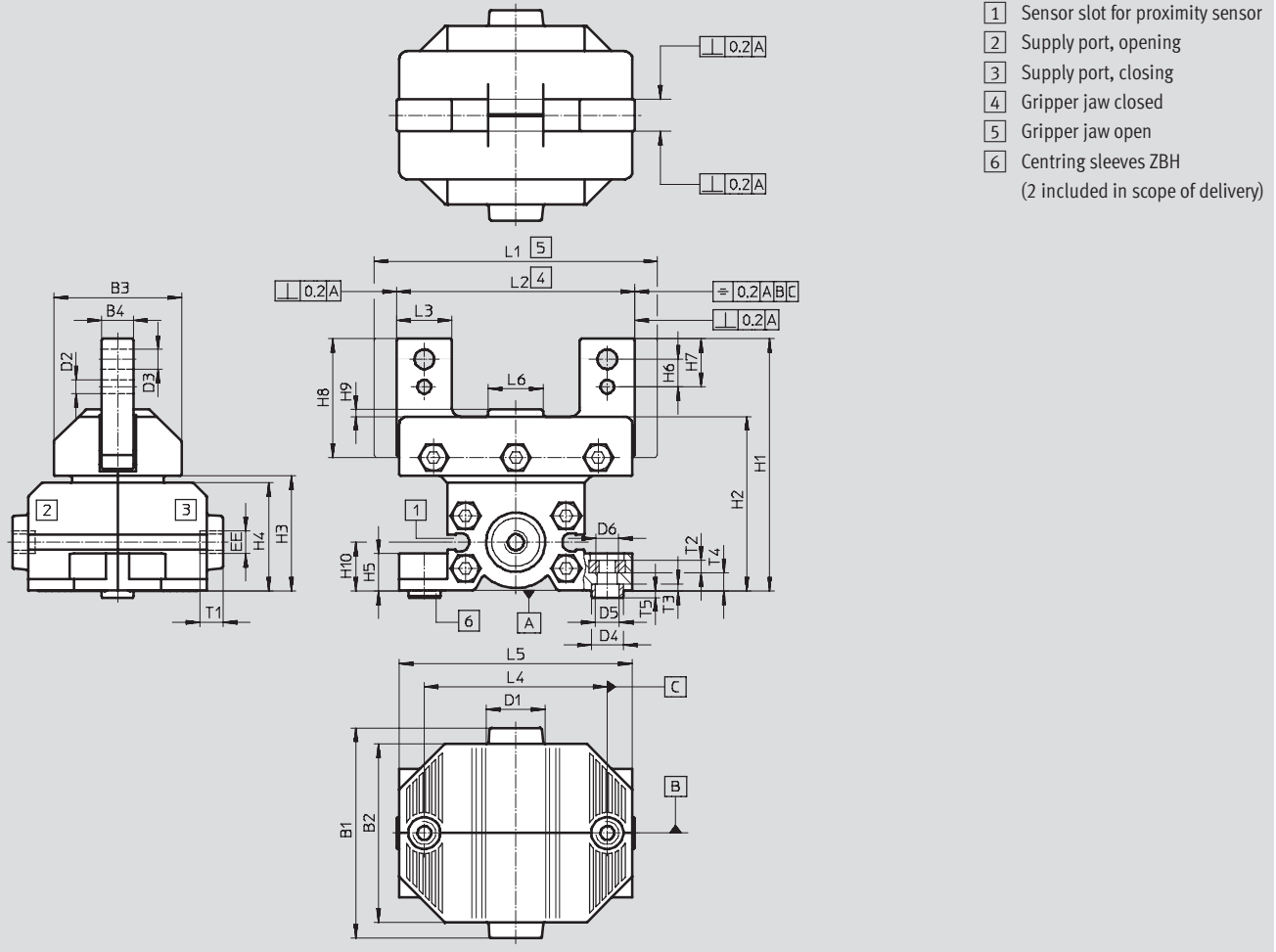

Size	B1	B2	B3	B4	D1	D2	D3	D4	D5	D6
[mm]				±0.1				∅	∅	
							±0.1	F10/h7		
12	38	33	22.4	6	12	2.5 ^{+0.04/+0.01}	3.3	7	5.3	M4
16	46	39	28	7	12	3 ^{H8}	4.3	7	5.3	M5
20	57	50	35	8	12	4 ^{H8}	5.3	9	6.4	M6

Size	EE	H1	H2	H3	H4	H5	H6	H7	H8	H9	H10
[mm]		±0.5							-0.2		
12	M5	48.2	33.6	21.7	20.2	6.9	5 ^{+0.05/-0.1}	9 ^{+0.05/-0.1}	25	1.2	9.2
16	M5	55.2	38.2	25.2	23.7	8.2	6±0.1	10.5±0.4	28.5	1.5	10.7
20	M5	68.7	48.2	32.5	30.5	10.2	7.5±0.1	13±0.4	34.5	1.5	13.7

Size	L1	L2	L3	L4 ¹⁾	L5	L6	T1	T2	T3	T4	T5
[mm]	±0.5	±0.5					min.		±0.1	+0.4	+0.1
										-0.3	-0.3
12	45	39	10 ^{-0.02/-0.06}	33	42	10	4.5	2.2	1.7	3.1	1.3
16	62	52	12 ^{-0.05}	40	51	12	4.5	2.7	1.8	3.8	1.2
20	76	63	14 ^{-0.05}	50	65	16	4.5	3.2	2.3	5.2	1.7

1) Tolerance for centring hole ±0.03
Tolerance for thread ±0.1

Parallel grippers HGPC

Technical data

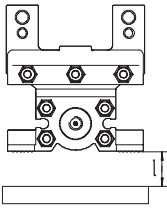

Minimum distance l between gripper and ferritic object			
		12	16
Distance	[mm]	10	

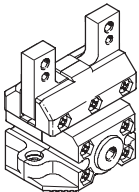
Ordering data				
	Size [mm]	Double-acting Without compression spring		Single-acting or with gripping force retention
		Part No.	Type	Closed Part No. Type
	12	539 267	HGPC-12-A	539 268 HGPC-12-A-G2
	16	539 269	HGPC-16-A	539 270 HGPC-16-A-G2
	20	539 271	HGPC-20-A	539 272 HGPC-20-A-G2

Parallel grippers HGPC



Accessories

Ordering data – Centring sleeves				Technical data → 1 / 10.1-3	
	For size [mm]	Weight [g]	Part No.	Type	PU ¹⁾
		12, 16	1	186 717	ZBH-7
	20	1	150 927	ZBH-9	10

1) Packaging unit quantity

Ordering data – Proximity sensors for rounded slot, longitudinal connecting cable				Technical data → www.festo.com/catalogue/sm	
	Assembly	Electrical connection		Cable length [m]	Part No. Type
		Cable	M8 plug		
NO contact, magneto-resistive					
Insertable from end		3-wire	–	2.5	173 218 SMT-10-PS-KL-LED-24
		–	3-pin	0.3	173 220 SMT-10-PS-SL-LED-24
NO contact, magnetic reed					
Insertable from end		3-wire	–	2.5	173 210 SME-10-KL-LED-24
		–	3-pin	0.3	173 212 SME-10-SL-LED-24

Ordering data – Proximity sensors for rounded slot, lateral connecting cable				Technical data → www.festo.com/catalogue/sm	
	Assembly	Electrical connection		Cable length [m]	Part No. Type
		Cable	M8 plug		
NO contact, magneto-resistive					
Insertable from end		3-wire	–	2.5	173 219 SMT-10-PS-KQ-LED-24
		–	3-pin	0.3	173 221 SMT-10-PS-SQ-LED-24
NO contact, magnetic reed					
Insertable from end		3-wire	–	2.5	173 211 SME-10-KQ-LED-24
		–	3-pin	0.3	173 213 SME-10-SQ-LED-24

Ordering data – Connecting cables				Technical data → www.festo.com/catalogue/nebu	
	Electrical connection, left	Electrical connection, right	Cable length [m]	Part No.	Type
		Straight socket, M8x1, 3-pin	Cable, open end, 3-wire	2.5	541 333
5				541 334	NEBU-M8G3-K-5-LE3
	Angled socket, M8x1, 3-pin	Cable, open end, 3-wire	2.5	541 338	NEBU-M8W3-K-2.5-LE3
			5	541 341	NEBU-M8W3-K-5-LE3