

Three-point grippers HGDT, robust

FESTO

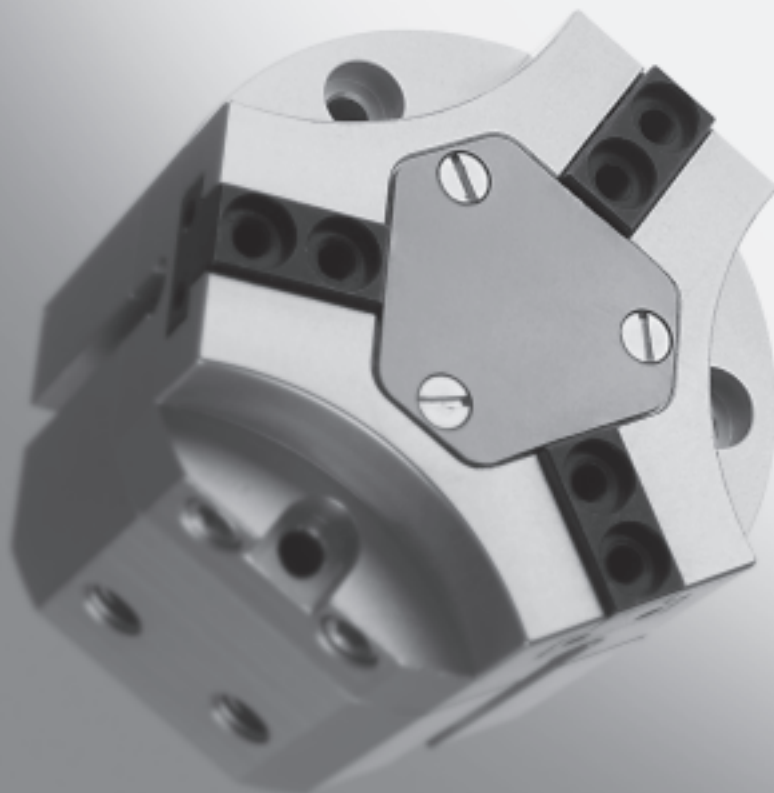

- Powerful and reliable for heavy-duty use
- With gripping force retention
- Splash-proof via sealing air
- Versatile thanks to wide range of mounting options

Three-point grippers HGDT, robust

Features



At a glance

The force generated by the linear motion is translated into the gripper jaw movement via a force-guided triple wedge mechanism. This also guarantees synchronous movement of the gripper jaw. The virtually backlash-free slideway is realised using ground-in gripper jaws.

A wide range of uses:

- Double-acting gripper
- Compression springs for supplementing or retaining gripper forces, or for use as a single-acting gripper with only one compressed air connection
- Suitable for external and internal gripping

Sealing air connection:

Compressed air flows past the gripper jaw when sealing air (max. 0.5 bar) is connected.

This prevents particles and soluble oil, etc. from entering the gripper jaw guides.

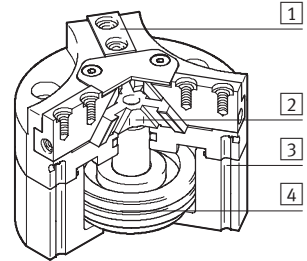

- 1 Three-point gripper jaw
- 2 Triple wedge mechanism
- 3 Slot for proximity sensor
- 4 Piston with magnet



Gripper selection software
www.festo.com/en/engineering

Wide range of air connections

Direct from the front

Via adapter plate from underneath

Mounting options

Direct mounting from above

Via adapter plate from underneath

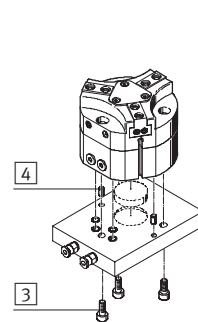
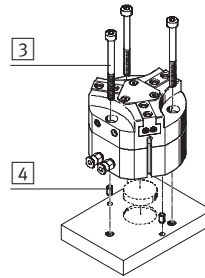
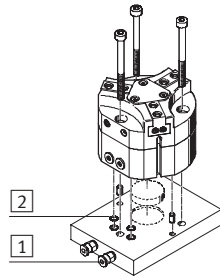
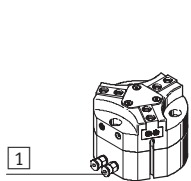

- 1 Compressed air connections
- 2 O-rings

- 3 Mounting screws
- 4 Centring pins or centring disc

 Note

Grippers are not designed for use in the following applications:

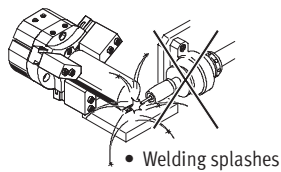

Three-point grippers HGDT, robust

Peripherals overview and type codes

Peripherals overview

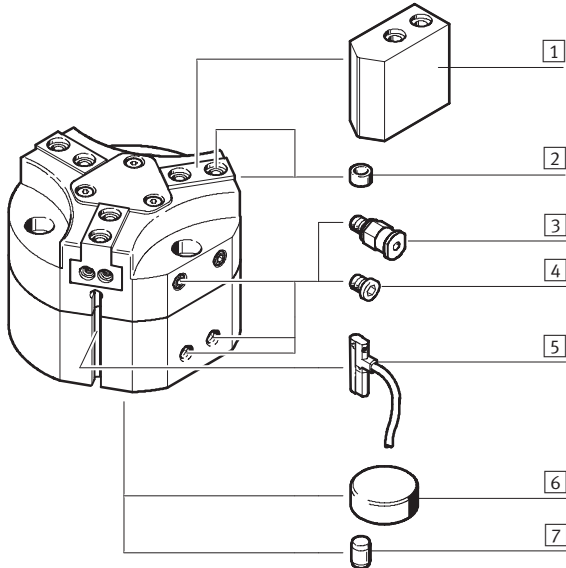

System product for handling and assembly technology

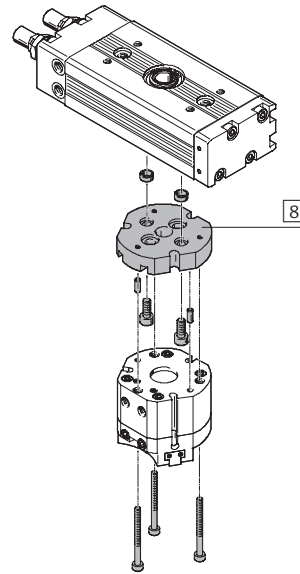

Accessories			
Type	Brief description	→ Page	
1	Unmachined gripper finger BUB-HGDT	Unmachined part specially matched to the gripper jaws for custom building of gripper fingers	1 / 7.5-12
2	Centring sleeve ZBH	For centring unmachined gripper jaws/gripper fingers on the gripper jaws	1 / 7.5-13
3	Push-in fitting QS	For connecting compressed air tubing with standard external diameters	Volume 3
4	Blanking plugs B	For sealing compressed air connections when using air connections at the front	1 / 7.5-13
5	With position sensing magnet SMT-10	For sensing the piston position, 3 slots available	1 / 7.5-13
6	Central mounting SLZZ	For centring the gripper when mounting	1 / 7.5-13
7	Locating pin	For centring the gripper when mounting	-
8	-	Drive/gripper connections	Volume 5

Type code

HGDT		-	25	-	A	-	G1
Type							
HGDT	Three-point gripper						
Size							
Position sensing							
A	For proximity sensing						
Gripping force retention							
G1	Open						
G2	Closed						

Three-point grippers HGDT, robust

Technical data

Function
Double-acting
HGDT-...-A

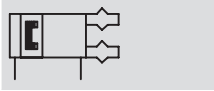

 Size
25 ... 63

 Stroke
3 ... 10 mm



Single-acting or
with gripping force retention ...
... open HGDT-...-G1



... closed HGDT-...-G2



General technical data						
Size	25	35	40	50	63	
Constructional design	Wedge-shaped actuator Force-guided motion sequence					
Mode of operation	Double-acting					
Gripper function	3-point					
Number of gripper jaws	3					
Max. applied load per external gripper finger ¹⁾ [N]	0.1	0.3	0.7	1.6	2.5	
Stroke per gripper jaw [mm]	3	4	6	8	10	
Pneumatic connection	M5	M5	M5	G1/8	G1/8	
Pneumatic connection Sealing air	M5					
Repetition accuracy ²⁾ [mm]	≤ 0.03					
Max. operating frequency [Hz]	≤ 4					
Position sensing	For proximity sensing					
Type of mounting	Via through-hole, locating pin or centring disc Via female thread, locating pin or centring disc					
Mounting position	Any					

- 1) Valid for unthrottled operation
2) Concentric to the central shaft

Operating and environmental conditions			
Min. operating pressure	HGDT-...-A [bar]	3	
	HGDT-...-G... [bar]	4	
Max. operating pressure	[bar]	8	
Sealing air operating pressure	[bar]	0 ... 0.5	
Operating medium	Filtered compressed air, lubricated or unlubricated		
Ambient temperature ¹⁾	[°C]	+5 ... +60	
Corrosion resistance class CRC ²⁾	2		

- 1) Note operating range of proximity sensors
2) Corrosion resistance class 2 to Festo standard 940 070
Components subject to moderate corrosion stress. Externally visible parts with primarily decorative surface requirements which are in direct contact with a normal industrial environment or media such as coolants or lubricating agents

Three-point grippers HGDT, robust

Technical data

Weights [g]					
Size	25	35	40	50	63
HGDT-...-A	185	307	712	1,104	1,873
HGDT-...-G1	203	337	840	1,592	2,469
HGDT-...-G2	203	385	837	1,440	2,543

Materials

Sectional view

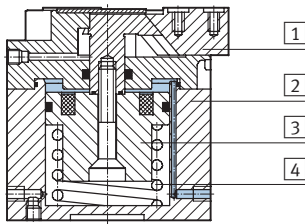

Three-point gripper		
1	Gripper jaw	Hardened steel
2	Housing	Aluminium, coated with CompCote
3	Piston	Anodised aluminium
4	Spring	Spring steel
-	Seals	Nitrile rubber
Material note		Copper, PTFE and silicone-free

Gripping force [N] at 6 bar

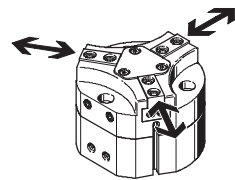

Size	25	35	40	50	63
Gripping force per gripper jaw					
opening	82	164	229	347	576
closing	69	152	206	307	551
Total gripping force					
opening	246	492	687	1,041	1,728
closing	207	456	618	921	1,653
Total gripping force with spring support (gripping force retention)					
opening	286	555	814	1,159	2,186
closing	228	547	712	1,052	2,172

Characteristic load values at the gripper jaws

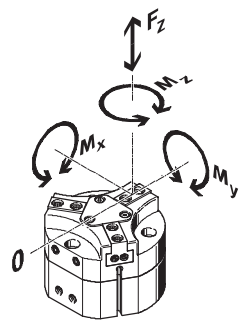

The indicated permissible forces and torques apply to a single gripper jaw. They include the lever arm, additional applied loads due to the workpiece or external gripper fingers, and acceleration forces occurring

during movement. The zero coordinate line (gripper finger point of rotation) must be taken into consideration for the calculation of torques.

Size	25	35	40	50	63	
Max. permissible force F_z	[N]	350	400	800	1,500	2,500
Max. permissible torque M_x	[Nm]	7	15	30	50	80
Max. permissible torque M_y	[Nm]	10	10	20	30	50
Max. permissible torque M_z	[Nm]	5	10	25	40	60

Three-point grippers HGDT, robust

Technical data

Moment of inertia [kgcm²]

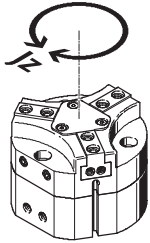

Requirements:

- The reference point is the central axis
- Without external gripper fingers
- In the load-free state

Size	25	35	40	50	63
HGDT-...-A	0.48	1.17	4.37	11.05	28.77
HGDT-...-G1	0.5	1.37	5.59	15.33	42.44
HGDT-...-G2	0.5	1.37	5.23	13.92	39.50

Opening and closing times [ms] at 6 bar

Without external gripper fingers

With external gripper fingers

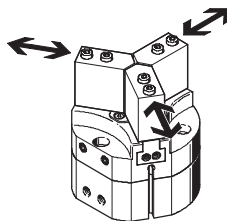
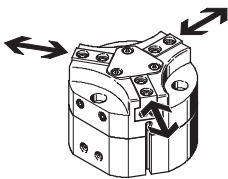

The indicated opening and closing times [ms] have been measured at room temperature at an operating pressure of 6 bar with horizontally mounted gripper without additional

gripper fingers. The grippers must be throttled for greater applied loads. Opening and closing times must then be adjusted accordingly.

Size		25	35	40	50	63
Without external gripper fingers						
HGDT-...-A	opening	28	40	62	85	152
	closing	25	45	59	75	142
HGDT-...-G1	opening	27	32	58	32	48
	closing	33	56	160	146	246
HGDT-...-G2	opening	33	46	111	61	159
	closing	25	35	87	70	107

With external gripper fingers per gripper finger (as a function of applied load)

HGDT-...	0.2 N	80	-	-	-	-
	0.3 N	100	130	-	-	-
	0.7 N	150	200	115	-	-
	1 N	180	240	140	-	-
	1.5 N	220	290	170	-	-
	2 N	-	335	200	190	-
	2.5 N	-	-	220	210	190
	3 N	-	-	-	230	200
	4 N	-	-	-	270	230
	5 N	-	-	-	-	260

Three-point grippers HGDT, robust

Technical data

Gripping force F_{Grip} per gripper jaw as a function of operating pressure and lever arm x

The gripping forces, as a function of operating pressure and lever arm, can be determined from the following charts.

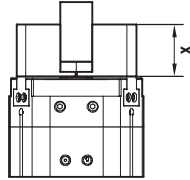

External gripping (closing)

HGDT-25-A

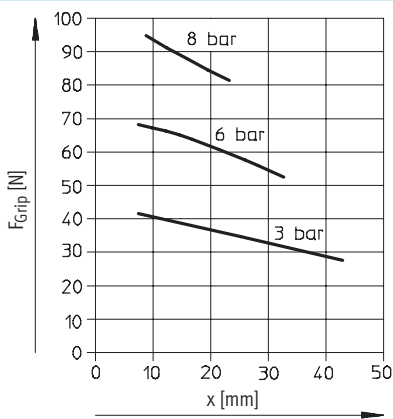

HGDT-35-A

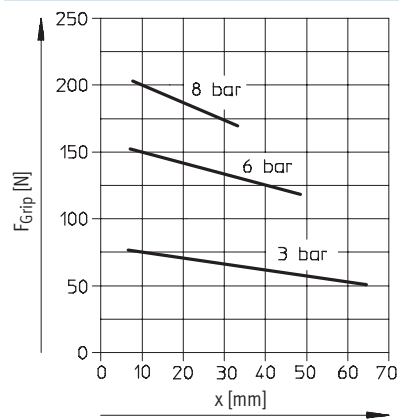

HGDT-40-A

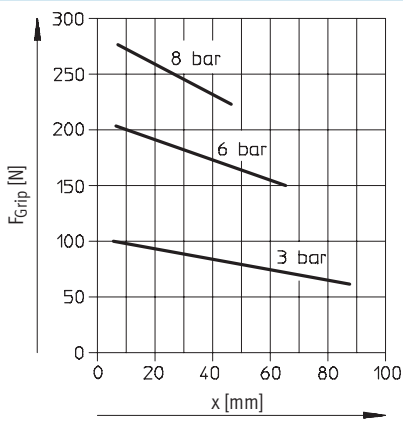

HGDT-50-A

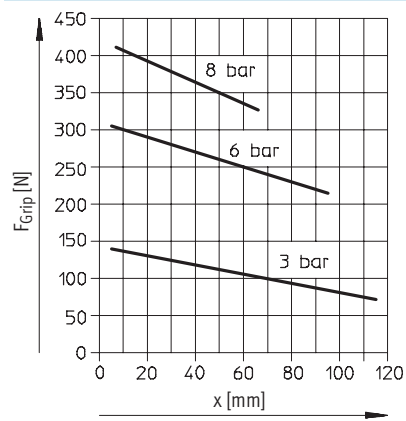

HGDT-63-A

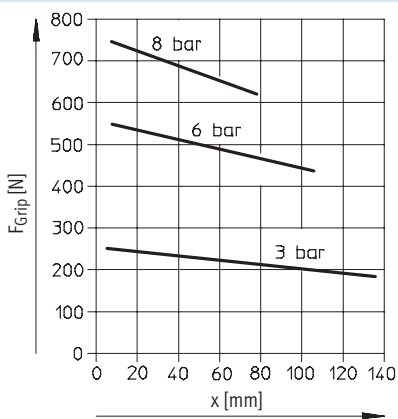

Three-point grippers HGDT, robust

Technical data

Gripping force F_{Grip} per gripper jaw as a function of operating pressure and lever arm x
Internal gripping (opening)

HGDT-25-A

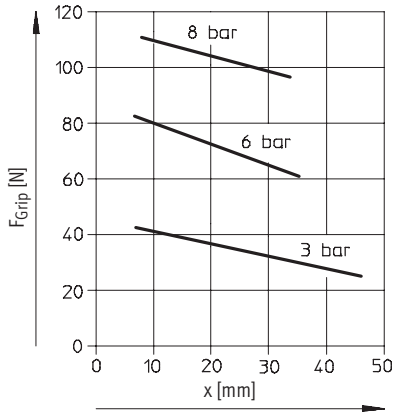

HGDT-35-A

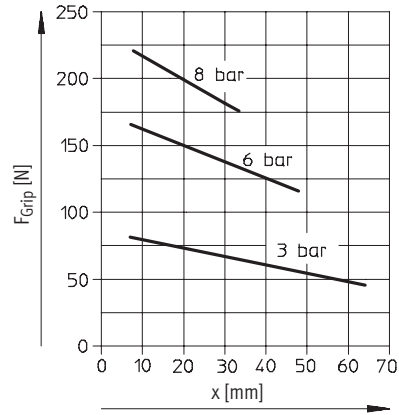

HGDT-40-A

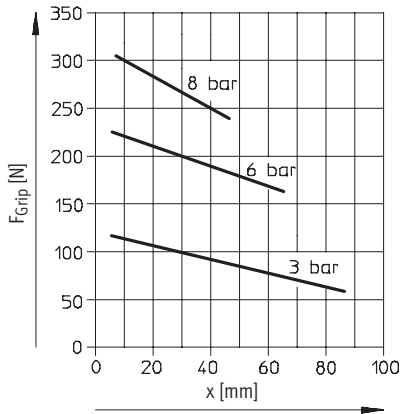

HGDT-50-A

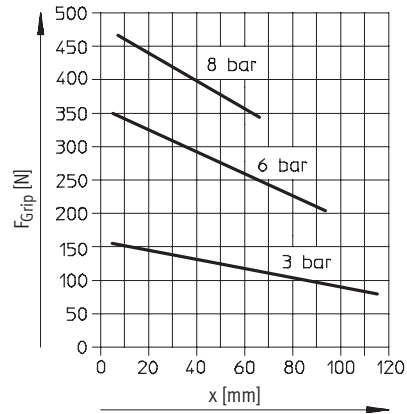

HGDT-63-A

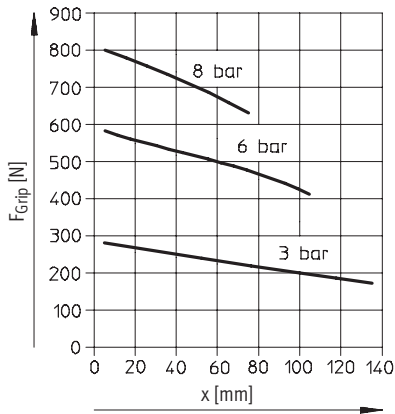

Three-point grippers HGDT, robust

Technical data

Spring force F_F as a function of size, gripper jaw stroke l and gripper length x , per gripper finger

Gripping force retention for HGDT-...-G...

The spring forces F_F as a function of the gripper jaw stroke can be determined from the following chart.

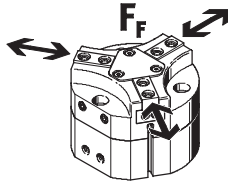

Size 25 ... 63

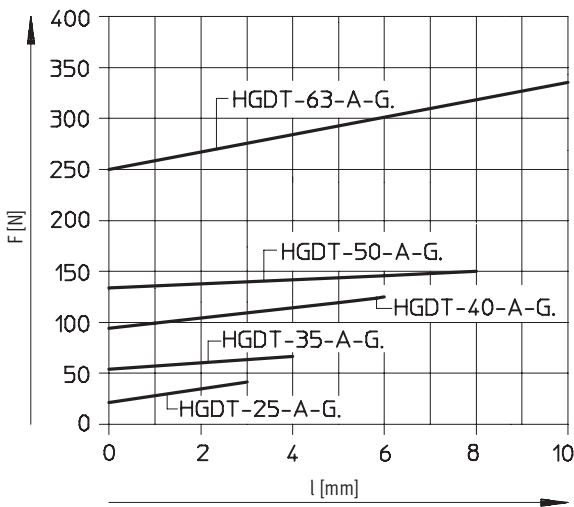

The lever arm x [mm] must be taken into consideration when determining the actual spring force F_{Stotal} . The formulae for calculating the spring force are provided in the table opposite.

Size	F_{Stotal} , per gripper finger
25	$-0.3 * x + 0.85 * F_{Spring}$
35	$-0.5 * x + 0.75 * F_{Spring}$
40	$-0.5 * x + 0.8 * F_{Spring}$
50	$-0.6 * x + 0.7 * F_{Spring}$
63	$-0.6 * x + 0.75 * F_{Spring}$

Determining the actual gripping forces F_{Gr} for HGDT-...-A-G1 and HGDT-...-A-G2 depending on the application, per gripper finger

The three-point slot grippers with integrated spring type HGDT-...-G1 (opening gripping force retention) and HGDT-...-G2 (closing gripping force retention) can be used as:

- single-acting grippers
- grippers with supplementary gripping force and
- grippers with gripping force retention depending on the requirements.

In order to calculate the available force (F_{Stotal}) must be combined accordingly. the gripping force (F_{Grip}) and spring

Application forces per gripper finger

Single-acting

- Gripping with spring force:
 $F_{Gr} = F_{Stotal}$
- Gripping with pressure force:
 $F_{Gr} = F_{Grip} - F_{Stotal}$

Supplementary gripping force

- Gripping with pressure and spring force:
 $F_{Gr} = F_{Grip} + F_{Stotal}$

Gripping force retention

- Gripping with spring force:
 $F_{Gr} = F_{Stotal}$

Three-point grippers HGDT, robust

Technical data

Dimensions

Download CAD data → www.festo.com/en/engineering

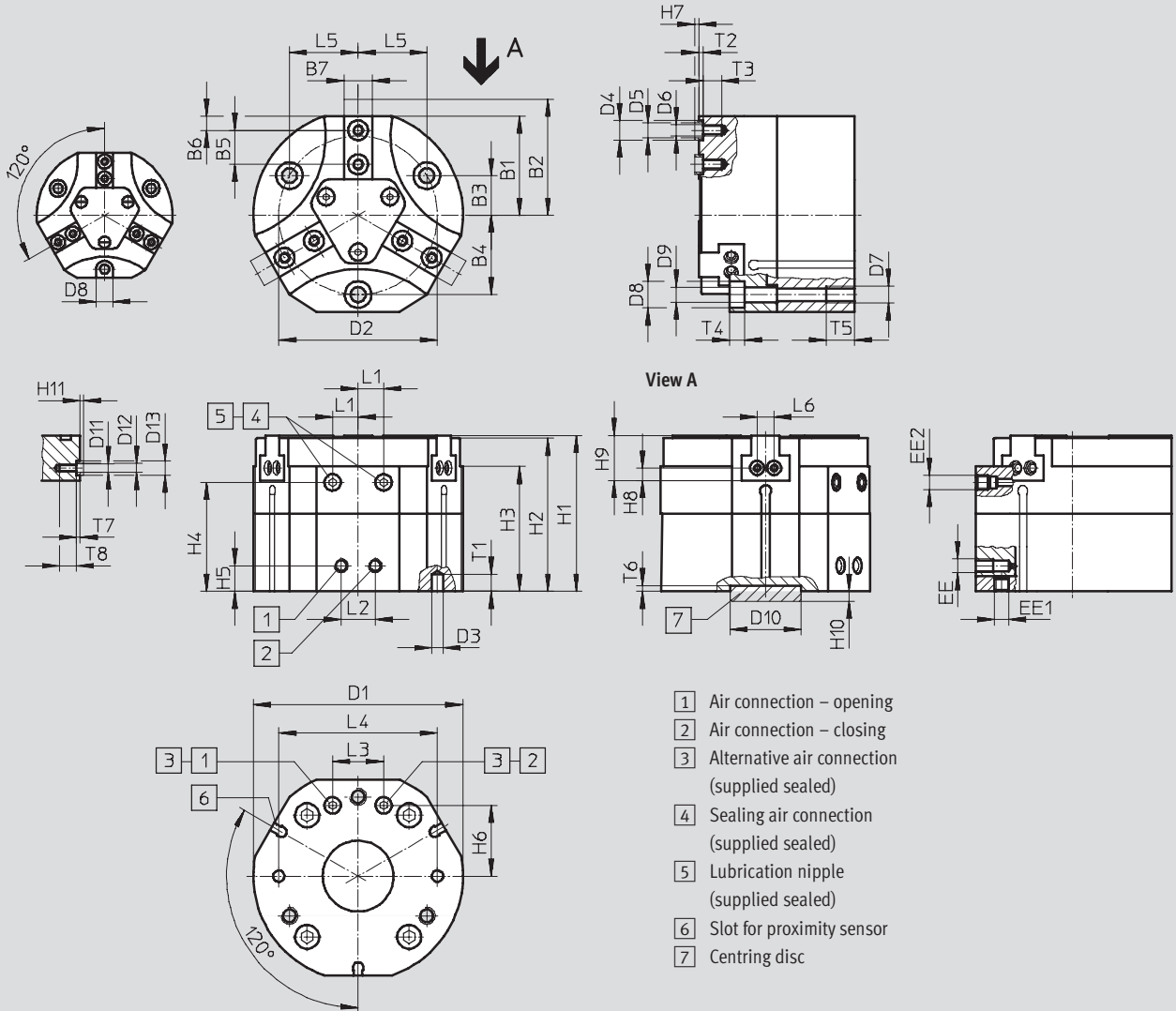

Handling units
Three-point grippers
7.5

Size	B1	B2	B3	B4	B5	B6	B7	D1	D2	D3	D4	D5
[mm]	±0.5	±0.5			±0.02	±0.02	-0.05 -0.1	∅ ±0.1	∅ ±0.1	∅ H8	∅ H8/h7	∅
HGDT-25-A	22	25	9.5	19	6	3	6	48	38	3	5	3.2
HGDT-25-A-G...												
HGDT-35-A	27	31	11	22	8	4	6.5	58	44	3	5	3.2
HGDT-35-A-G...												
HGDT-40-A	35	41	14	28	12	5	10	74	56	4	7	5.3
HGDT-40-A-G...												
HGDT-50-A	43.5	51.5	17.5	35	15	6	12	93	70	5	9	6.4
HGDT-50-A-G...												
HGDT-63-A	54	64	22.5	45	18	10	14	116	90	5	9	6.4
HGDT-63-A-G...												

Three-point grippers HGDT, robust

Technical data

FESTO

Size [mm]	D6 ∅	D7 ∅	D8 ∅ H13	D9 ∅ H13	D10 ∅ H8	D11	D12 ∅	D13 ∅ H8/h7	EE	EE1	EE2	H1 ±0.05
HGDT-25-A	M3	M4	5.9	3.3	14	M2	-	-	M5	M3	M5	41.5
HGDT-25-A-G...												
HGDT-35-A	M3	M4	5.9	3.3	25	M3	3.2	5	M5	M3	M5	46
HGDT-35-A-G...												52
HGDT-40-A	M4	M6	9.4	5.1	25	M3	3.2	5	M5	M5	M5	55
HGDT-40-A-G...												72
HGDT-50-A	M6	M8	10.2	6.4	25	M5	5.3	7	G $\frac{1}{8}$	M5	M5	64.5
HGDT-50-A-G...												82
HGDT-63-A	M6	M8	10.4	6.4	25	M5	5.3	7	G $\frac{1}{8}$	M5	M5	69
HGDT-63-A-G...												96

Size [mm]	H2 ±0.05	H3	H4	H5 ±0.1	H6 ±0.1	H7 -0.3	H8	H9 -0.02	H10 -0.2	H11 -0.3	L1 ±0.5	L2 ±0.1
HGDT-25-A	40.5	32.5	29.3	9	13.5	1.1	2.25±0.1	8.5	3.5	-	6	12
HGDT-25-A-G...												
HGDT-35-A	45	37	33.5	9	18.5	1.1	3±0.02	12	3.5	1.1	7	12
HGDT-35-A-G...	51	43	39.5									
HGDT-40-A	54	44	38.4	9	25	1.4	4.5±0.02	16	3.5	1.1	9	12
HGDT-40-A-G...	71	61	55.4									
HGDT-50-A	63.5	50.5	45	12	32	1.9	5.5±0.02	19	3.5	1.4	9	24
HGDT-50-A-G...	81	68	62.5									
HGDT-63-A	68	50	44.5	12	42	1.9	5.5±0.02	22	3.5	1.4	12	24
HGDT-63-A-G...	95	77	71.5									

Size [mm]	L3 ±0.1	L4 ±0.02	L5	L6	T1 min.	T2 +0.1	T3 min.	T4 +0.2	T5 min.	T6 +0.1	T7 +0.1	T8 min.
HGDT-25-A	12	38	16.45	6±0.1	3.5	1.3	5	3.2	8	2	-	3
HGDT-25-A-G...												
HGDT-35-A	15	45	19.05	6±0.02	5	1.3	5.5	3.2	8	2	1.3	6
HGDT-35-A-G...												
HGDT-40-A	18	56	24.25	6±0.02	6	1.6	6.5	5.1	10	2	1.3	6
HGDT-40-A-G...												
HGDT-50-A	18	70	30.31	13±0.02	8	2.1	10.5	6.1	12	2	1.6	9
HGDT-50-A-G...												
HGDT-63-A	24	90	38.97	13±0.02	8	2.1	10.5	6.1	12	2	1.6	9
HGDT-63-A-G...												

Ordering data							
Size [mm]	Double-acting without compression spring			Single-acting or with gripping force retention			
	Part No.	Type		open Part No.	Type	closed Part No.	Type
25	540 859	HGDT-25-A		540 860	HGDT-25-A-G1	540 861	HGDT-25-A-G2
35	540 862	HGDT-35-A		540 863	HGDT-35-A-G1	540 864	HGDT-35-A-G2
40	540 865	HGDT-40-A		540 866	HGDT-40-A-G1	540 867	HGDT-40-A-G2
50	540 868	HGDT-50-A		540 869	HGDT-50-A-G1	540 870	HGDT-50-A-G2
63	540 871	HGDT-63-A		540 872	HGDT-63-A-G1	540 873	HGDT-63-A-G2

Three-point grippers HGDT, robust

Accessories

Unmachined gripper finger

BUB-HGDT

(scope of delivery: 3 pieces)

Material:

Wrought aluminium alloy

Copper, PTFE and silicone-free

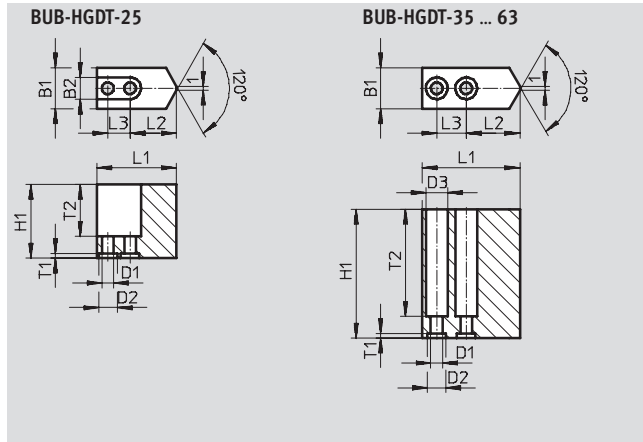

Dimensions and ordering data							
For size	B1	B2	D1	D2	D3	H1	L1
[mm]	±0.05	+0.22	∅ H13	∅ H8	∅ +0.22	±0.05	±0.05
25	11	5.9	3.2	5	–	20	21.6
35	11	–	3.2	5	5.9	35	26.5
40	16	–	4.3	7	7.4	50	34
50	20	–	6.3	9	10.4	65	42
63	24	–	6.3	9	10.4	80	52



For size	L2	L3	T1	T2	Weights per unmachined part [g]	Part No.	Type
[mm]	±0.02 ¹⁾ ±0.1 ²⁾	±0.01 ¹⁾ ±0.1 ¹⁾	+0.1				
25	12.6	6	1.3	14	10	541 101	BUB-HGDT-25
35	14.5	8	1.3	29	22	541 102	BUB-HGDT-35
40	17	12	1.6	45	59	541 103	BUB-HGDT-40
50	21	15	2.1	58	112	541 104	BUB-HGDT-50
63	24	18	2.1	73	222	541 105	BUB-HGDT-63

1) For centring
2) For through-hole

Three-point grippers HGDT, robust

Accessories



FESTO

Ordering data						
	For size [mm]	Remarks	Weights [g]	Part No.	Type	PU ¹⁾
Centring sleeve Technical data → 1 / 10.1-3						
	25, 35	For centring unmachined gripper jaws/gripper fingers on the gripper jaws	1	189 652	ZBH-5	10
	40		1	186 717	ZBH-7	10
	50, 63		1	150 927	ZBH-9	10
	35, 40	For lateral centring of gripper fingers on the gripper jaws	1	189 652	ZBH-5	10
	50, 63		1	186 717	ZBH-7	10
Central mounting Technical data → 1 / 10.1-3						
	25	For centring the gripper when mounting	21	150 900	SLZZ-16/10	–
	35, 40, 50, 63		40	150 901	SLZZ-25/16	–
Blanking plugs Technical data → 1 / 10.1-3						
	25 ... 63	For sealing the compressed air connections	0.6	30 979	B-M3-S9	10
			1	174 308	B-M5-B	10
			5	3 568	B-1/8	10

1) Packaging unit quantity

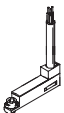
Ordering data – Proximity sensors for rounded slot, longitudinal connecting cable					Technical data → www.festo.com/catalogue/sm	
	Assembly	Electrical connection		Cable length [m]	Part No.	Type
		Cable	M8 plug			
NO contact, magneto-resistive						
	Insertable from end	–	3-pin	0.3	173 220	SMT-10-PS-SL-LED-24
		3-wire	–	2.5	173 218	SMT-10-PS-KL-LED-24

Ordering data – Proximity sensors for rounded slot, lateral connecting cable					Technical data → www.festo.com/catalogue/sm	
	Assembly	Electrical connection		Cable length [m]	Part No.	Type
		Cable	M8 plug			
NO contact, magneto-resistive						
	Insertable from end	3-wire	–	2.5	173 219	SMT-10-PS-KQ-LED-24
		–	3-pin	0.3	173 221	SMT-10-PS-SQ-LED-24

Ordering data – Connecting cables				Technical data → www.festo.com/catalogue/nebu	
	Electrical connection, left	Electrical connection, right	Cable length [m]	Part No.	Type
	Straight socket, M8x1, 3-pin	Cable, open end, 3-wire	2.5	541 333	NEBU-M8G3-K-2.5-LE3
			5	541 334	NEBU-M8G3-K-5-LE3
	Angled socket, M8x1, 3-pin	Cable, open end, 3-wire	2.5	541 338	NEBU-M8W3-K-2.5-LE3
			5	541 341	NEBU-M8W3-K-5-LE3

