



- Swivelling and clamping via integrated guide
- Swivel direction freely selectable and subsequently adjustable
- Compact
- Versatile
- Easy to maintain
- Clamping finger can be ordered as an accessory

Linear/swivel clamps CLR

Key features



Functional description

The CLR linear/swivel clamp is used for all types of clamping. Through the combination of the linear and swivel motion of the piston rod, it is possible to insert and remove workpieces even

beyond the clamping range. Here it is possible to choose between swivelling to the right or left, while the CLR also boasts a linear stroke as of $\varnothing 40$.

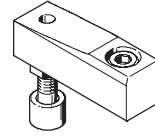

Clamping finger:
Can be ordered as an accessory

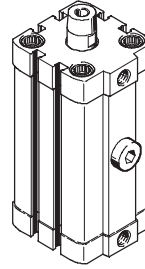

Optimal range

- Simple mechanical system
- Robust design
- Long service life
- Low initial, assembly and maintenance expenditure
- New: CLR with protection against dust and welding splatter

Versatile

- Subsequently adjustable swivel direction
- Compact dimensions for the tightest installation spaces

Easy to assemble

- The port pattern corresponds to ISO 21287, meaning that foot and flange mountings from the standard accessories range can be used
- Female threads in the bearing and end cap enable simple assembly of the cylinder either directly or using mounting accessories

Practical

- Clamping finger including slip-on rubber cap to protect sensitive surfaces are available as accessories
- Clamping finger can be freely adjusted across a full 360°
- Can be repaired with wearing parts kit

Swivel direction



Swivel motion to right

Viewed from above the piston rod side with the piston rod retracted. Clockwise swivel direction.



Swivel motion to left

Viewed from above the piston rod side with the piston rod retracted. Anti-clockwise swivel direction.



Linear motion

Linear/swivel clamps CLR

Peripherals overview

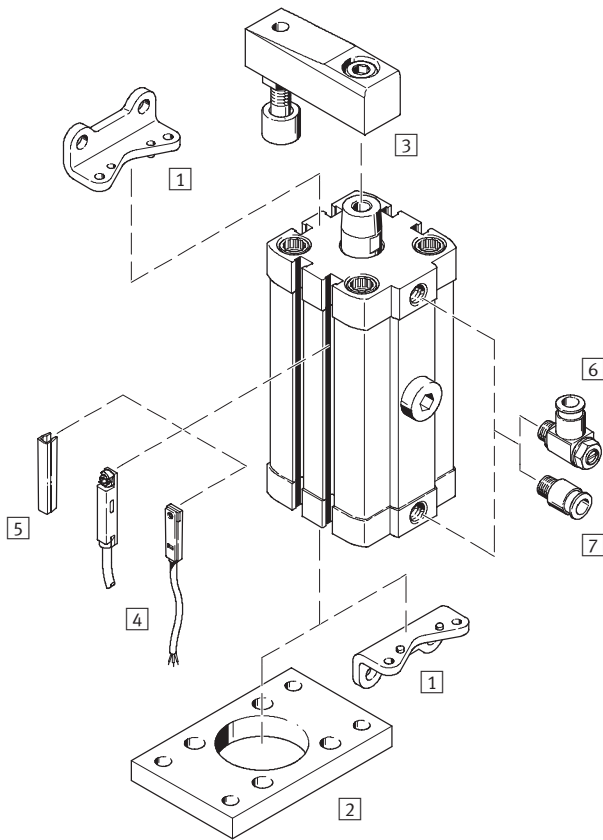

Mounting attachments and accessories		
	Brief description	→ Page
1	Foot mounting HNA	1 / 5.5-13
2	Flange mounting FNC	1 / 5.5-14
3	Clamping finger CLR-...-FS	1 / 5.5-14
4	Proximity sensors SME/SMT	1 / 5.5-16
5	Slot cover ABP-5-S	1 / 5.5-16
6	One-way flow control valve GRLA/GRLZ	1 / 5.5-15
7	Push-in/threaded fitting QS	Volume 3

 **New**
Variant K11-R8

Linear/swivel clamps CLR

Type code

FESTO

		CLR	-	12	-	10	-	R	-	P	-	A	-		-	
Type																
Double-acting																
CLR	Linear/swivel clamp															
Piston Ø [mm]																
Clamping stroke [mm]																
Swivel direction																
R	Right															
L	Left															
G	Linear	1														
Cushioning																
P	Flexible cushioning rings/plates at both ends															
Position sensing																
A	For proximity sensing															
Variant																
K11-R8 	With protection against dust and welding splatter	2														
Series																
B	Series B	3														



- 1 Only with piston Ø 40 ... 63 mm
 2 Only with piston Ø 25 ... 63 mm
 3 Only with piston Ø 32 mm

Linear/swivel clamps CLR

Technical data

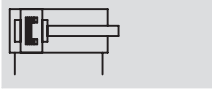
Function



-  Diameter
12 ... 63 mm
-  Clamping stroke
10, 20, 50 mm
-  [www.festo.com/en/
Spare_parts_service](http://www.festo.com/en/Spare_parts_service)



General technical data																	
Piston Ø	12	16	20	25	32	40	50	63									
Pneumatic connection	M5	M5	M5	M5	G1/8	G1/8	G1/8	G1/8									
Piston-rod thread	M3	M4	M6	M6	M8	M8	M10	M10									
Operating medium	Filtered compressed air, lubricated or unlubricated																
Design	Piston																
	Piston rod																
	Cylinder barrel																
Cushioning	Flexible cushioning rings/plates at both ends																
Position sensing	For proximity sensing																
Type of mounting	Via through-holes																
	Via female thread																
	Via accessories																
Mounting position	Any																
Clamping range	≥ 2 mm before end position																
Clamping stroke ¹⁾	[mm]	10	20	10	20	10	20	10	20	10	20	10	20	50	20	50	
Total stroke ²⁾	[mm]	19	29	20	30	22	32	23	33	28	38	28	38	41	71	43	73
Swivel direction		Right, left								Right, left, linear							
Swivel angle	[°]	90 ±1															

- 1) The clamping stroke corresponds to the linear stroke which effects clamping
 2) The total stroke comprises the clamping stroke and the swivel stroke

Operating and environmental conditions		
Operating pressure	[bar]	2 ... 10
Ambient temperature ¹⁾	[°C]	-10 ... +80
Corrosion resistance class CRC ²⁾		2

- 1) Note operating range of proximity sensors
 2) Corrosion resistance class 2 according to Festo standard 940 070
 Components requiring moderate corrosion resistance. Externally visible parts with primarily decorative surface requirements which are in direct contact with a surrounding industrial atmosphere or media such as cooling or lubricating agents

Linear/swivel clamps CLR

Technical data

FESTO

Forces [N] without clamping finger								
Piston Ø	12	16	20	25	32	40	50	63
Theoretical clamping force at 6 bar	51	90	121	227	362	633	990	1,682

Forces [N] with clamping finger CLR-...-FS, 5 mm before stroke end									
Piston Ø	12	16	20	25	32	40	50	63	
Effective clamping force at	2 bar	12	17	35	63	111	176	271	441
	4 bar	23	36	73	127	216	355	508	823
	6 bar	34	53	109	188	313	536	716	1,386

Materials

Sectional view

Basic version

K11-R8 with protection against dust and welding splatter

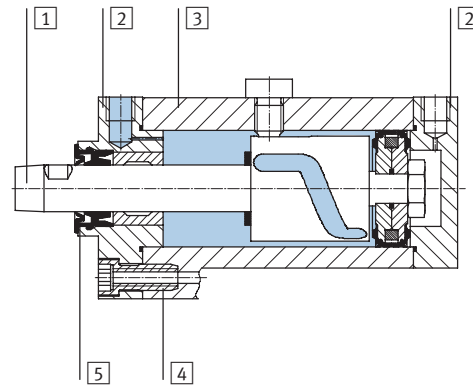
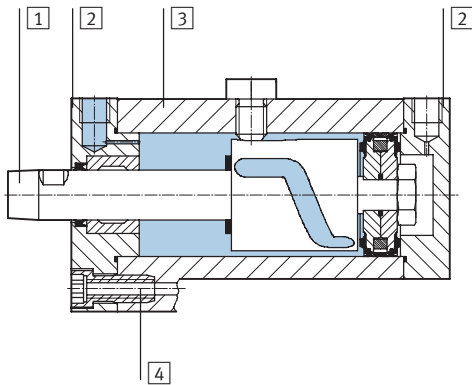

Linear/swivel clamp	Basic version	K11-R8
1 Piston rod	High-alloy steel	High-alloy steel, treated surfaces
2 Bearing and end caps	Wrought aluminium alloy, coated	
3 Cylinder barrel	Wrought aluminium alloy, smooth-anodised	
4 Flange screws	Galvanised steel	
5 Wiper seal	–	Polyphosphensulphide, flame-retardant
– Seals	Nitrile rubber, polyurethane	

Weights [g]									
Piston Ø	12	16	20	25	32	40	50	63	
Basic version									
Product weight at stroke	10 mm	135	160	335	395	685	880	–	–
	20 mm	160	190	385	455	765	985	1,650	2,100
	50 mm	–	–	–	–	–	–	2,115	2,635
Variant K11-R8									
Product weight at stroke	10 mm	–	–	–	410	700	895	–	–
	20 mm	–	–	–	470	785	1,010	1,690	2,100
	50 mm	–	–	–	–	–	–	2,155	2,625

Linear/swivel clamps CLR

Technical data



Dimensions Download CAD data → www.festo.com/en/engineering

Basic version Ø 12 ... 63

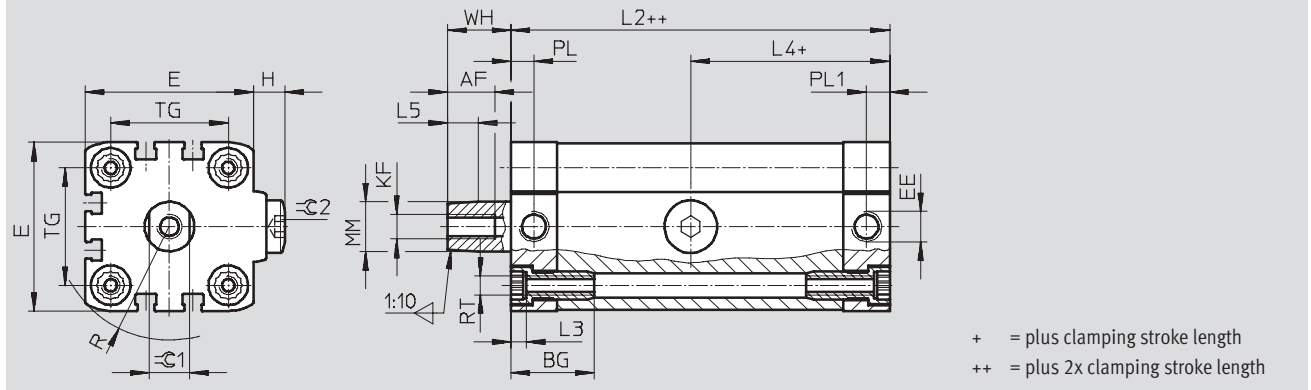

Variant K11-R8 Ø 25 ... 63

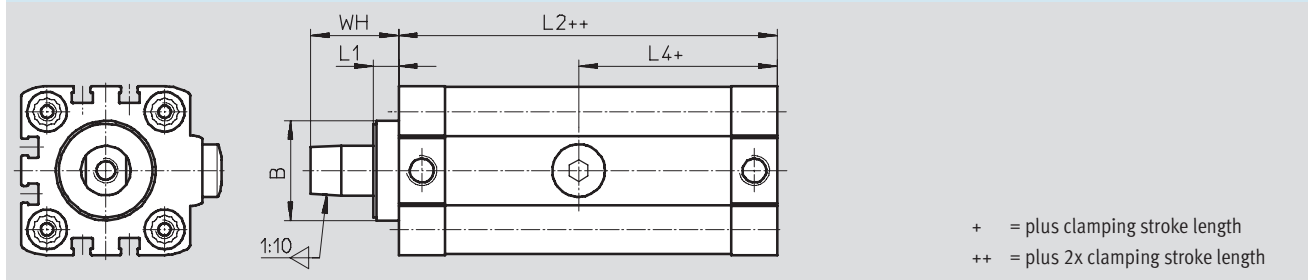

Ø	AF	BG	B	E	EE	H	KF	L1	L2	L3	L4
[mm]											
12	10	17	-	27.5	M5	3.25	M3	-	60.6	3.5	21.8
16	12			29			M4		62.5		23.5
20	15	19.5	35.5	4.75		M6	79.5		4.6	43.8	
25			28.4	39.5		82.5	46.55				
32			26	32.2	47	8.9	M8	101		53.05	
40	15	26	32.2	54.5	G $\frac{3}{8}$	10.15	8.1	102.5	4.6	54.3	
50				65.5		12.7		117.5		58.8	
63				75.5		14.2		124.5		62.75	

Ø	L5	MM Ø	PL	PL1	R	RT	TG	WH	⌀C1	⌀C2
[mm]								K11-R8		
12	4.9	6	6	15.1	18.2	M4	16	10.9	5	3
16		8	6.5	15	19.3		18		7	
20	7.4	12	6	6	23.7	M5	22	16.4	10	5
25					26.3		26		24.5	
32	9.9	16	7.5	7.5	31.5	M6	32.5	20.4	13	6
40					36.7		38			
50	10.3	20	7.5	7.5	44.3	M8	46.5	20.8	17	8
63					51.5		56.5			

Linear/swivel clamps CLR

Technical data



Assembly of a clamping finger

Step 1

- Place the clamping finger onto the tapered end of the piston rod.
- Screw the fixing screw into the threaded hole in the piston rod until the clamping finger can only just be turned.

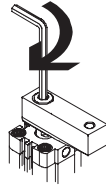

Step 2

- Securely grip the clamping finger with the screw head pointing upwards.
- Using a spanner, turn the piston rod via the spanner flats.

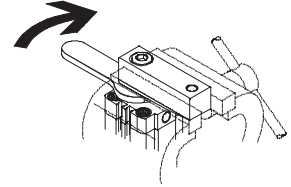

Step 3

- Tighten the fixing screw to the tightening torque quoted below.

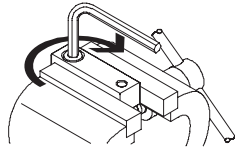

Tightening torque [Nm]

Piston Ø	12	16	20	25	32	40	50	63
Max. tightening torque fixing screw	1.2	3	12	12	24	24	47	47

- - Note

No calculations are required when using the Festo clamping finger set. The accessory is co-ordinated with the cylinder and can be operated unthrottled at the maximum

permissible pressure. When constructing the clamping finger in-house the following values must be checked and calculations performed.

Maximum permissible clamping arm length l depending on the operating pressure p

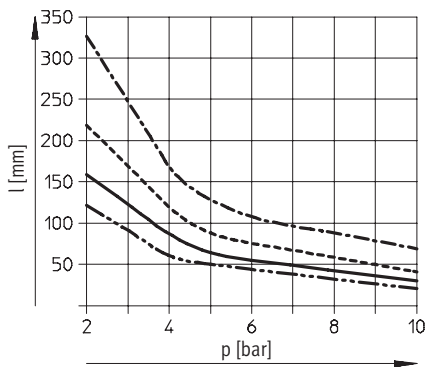

$\varnothing 12/16$
 $\varnothing 20/25$
 $\varnothing 32/40$
 $\varnothing 50/63$

Linear/swivel clamps CLR

Technical data

Maximum permissible mass moment of inertia J_0

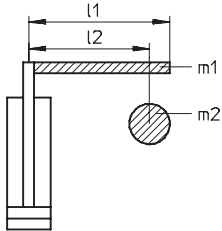

- m_1 = mass of the clamping finger
- l_1 = length of the clamping finger
- m_2 = mass of the screw
- l_2 = center distance between screw and piston rod



Note

The permissible mass moment of inertia at the piston rod depends on the cylinder's speed. To simplify, the moment can be calculated using this

formula. For calculation purposes, the software program "mass moments of inertia" is also available on the electronic catalogue.

Maximum permissible mass moment of inertia: $J_0 = \frac{m_1 \times l_1^2}{3} + m_2 \times l_2^2$

Mass moment of inertia J as a function of the time t required for the single stroke

Ø 12

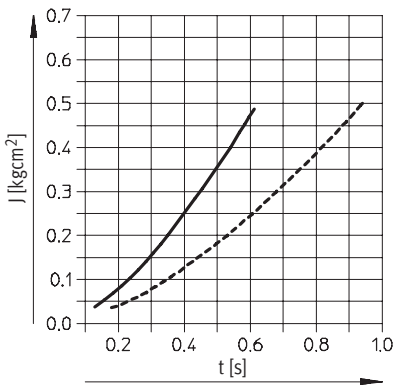

Ø 16

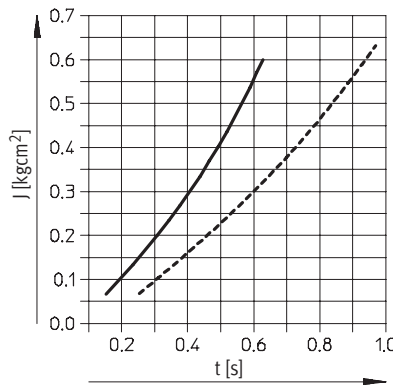

Ø 20/25

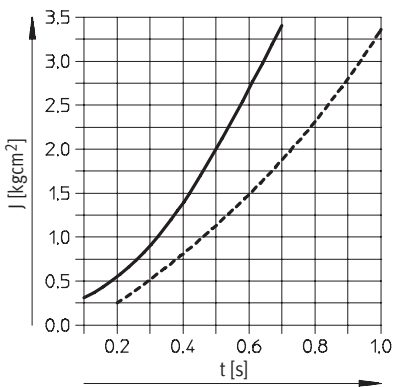

Ø 32/40

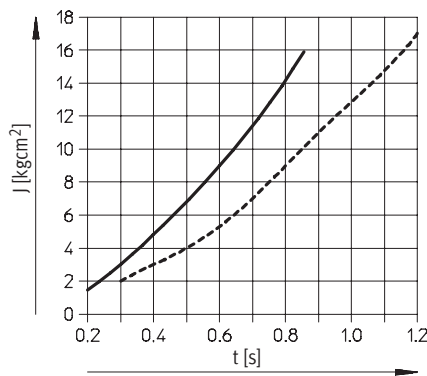

Ø 50/63

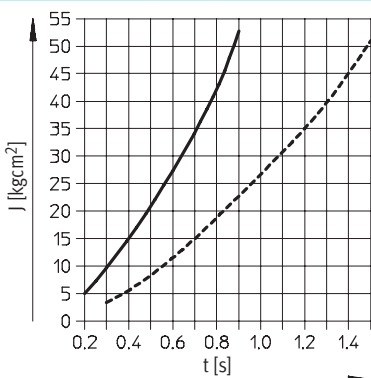



— Stroke: 10 mm
- - - Stroke: 20 mm

Linear/swivel clamps CLR

Technical data

FESTO

Ordering data – Right-hand swivel direction				
Type	Piston Ø [mm]	Stroke [mm]	Part No.	Type
	12	10	535 431	CLR-12-10-R-P-A
		20	535 433	CLR-12-20-R-P-A
	16	10	535 435	CLR-16-10-R-P-A
		20	535 437	CLR-16-20-R-P-A
	20	10	535 439	CLR-20-10-R-P-A
		20	535 441	CLR-20-20-R-P-A
	25	10	535 443	CLR-25-10-R-P-A
		20	535 445	CLR-25-20-R-P-A
	32	10	543 177	CLR-32-10-R-P-A-B
		20	543 179	CLR-32-20-R-P-A-B
	40	10	535 453	CLR-40-10-R-P-A
		20	535 456	CLR-40-20-R-P-A
	50	20	535 459	CLR-50-20-R-P-A
		50	535 462	CLR-50-50-R-P-A
	63	20	535 465	CLR-63-20-R-P-A
		50	535 468	CLR-63-50-R-P-A

Ordering data – Right-hand swivel direction, with protection against dust and welding splatter				
Type	Piston Ø [mm]	Stroke [mm]	Part No.	Type
	25	10	535 483	CLR-25-10-R-P-A-K11-R8
		20	535 485	CLR-25-20-R-P-A-K11-R8
	32	10	535 487	CLR-32-10-R-P-A-B-K11-R8
		20	535 490	CLR-32-20-R-P-A-B-K11-R8
	40	10	535 493	CLR-40-10-R-P-A-K11-R8
		20	535 496	CLR-40-20-R-P-A-K11-R8
	50	20	535 499	CLR-50-20-R-P-A-K11-R8
		50	535 502	CLR-50-50-R-P-A-K11-R8
	63	20	535 505	CLR-63-20-R-P-A-K11-R8
		50	535 508	CLR-63-50-R-P-A-K11-R8

Linear/swivel clamps CLR

Technical data

FESTO

Ordering data – Left-hand swivel direction				
Type	Piston Ø [mm]	Stroke [mm]	Part No.	Type
	12	10	535 432	CLR-12-10-L-P-A
		20	535 434	CLR-12-20-L-P-A
	16	10	535 436	CLR-16-10-L-P-A
		20	535 438	CLR-16-20-L-P-A
	20	10	535 440	CLR-20-10-L-P-A
		20	535 442	CLR-20-20-L-P-A
	25	10	535 444	CLR-25-10-L-P-A
		20	535 446	CLR-25-20-L-P-A
	32	10	543 178	CLR-32-10-L-P-A-B
		20	543 180	CLR-32-20-L-P-A-B
	40	10	535 454	CLR-40-10-L-P-A
		20	535 457	CLR-40-20-L-P-A
	50	20	535 460	CLR-50-20-L-P-A
		50	535 463	CLR-50-50-L-P-A
	63	20	535 466	CLR-63-20-L-P-A
		50	535 469	CLR-63-50-L-P-A

Ordering data – Left-hand swivel direction, with protection against dust and welding splatter				
Type	Piston Ø [mm]	Stroke [mm]	Part No.	Type
	25	10	535 484	CLR-25-10-L-P-A-K11-R8
		20	535 486	CLR-25-20-L-P-A-K11-R8
	32	10	535 488	CLR-32-10-L-P-A-B-K11-R8
		20	535 491	CLR-32-20-L-P-A-B-K11-R8
	40	10	535 494	CLR-40-10-L-P-A-K11-R8
		20	535 497	CLR-40-20-L-P-A-K11-R8
	50	20	535 500	CLR-50-20-L-P-A-K11-R8
		50	535 503	CLR-50-50-L-P-A-K11-R8
	63	20	535 506	CLR-63-20-L-P-A-K11-R8
		50	535 509	CLR-63-50-L-P-A-K11-R8

 **New**
Variant K11-R8

Linear/swivel clamps CLR

Technical data

FESTO

Ordering data – Linear motion				
Type	Piston Ø [mm]	Stroke [mm]	Part No.	Type
	40	10	535 455	CLR-40-10-G-P-A
		20	535 458	CLR-40-20-G-P-A
	50	20	535 461	CLR-50-20-G-P-A
		50	535 464	CLR-50-50-G-P-A
	63	20	535 467	CLR-63-20-G-P-A
		50	535 470	CLR-63-50-G-P-A

Ordering data – Linear motion, with protection against dust and welding splatter				
Type	Piston Ø [mm]	Stroke [mm]	Part No.	Type
	40	10	535 495	CLR-40-10-G-P-A-K11-R8
		20	535 498	CLR-40-20-G-P-A-K11-R8
	50	20	535 501	CLR-50-20-G-P-A-K11-R8
		50	535 504	CLR-50-50-G-P-A-K11-R8
	63	20	535 507	CLR-63-20-G-P-A-K11-R8
		50	535 510	CLR-63-50-G-P-A-K11-R8

 **Note**

The swivel device can be easily adjusted subsequently.
Example: A CLR-12-10-R-P-A (swivel to right) can be converted to type CLR-12-10-L-P-A (swivel to left) by removing the guide pin and turning the slotted guide plate.

Linear/swivel clamps CLR

Accessories



Foot mounting HNA

Material:
Galvanised steel
Free of copper, PTFE and silicone

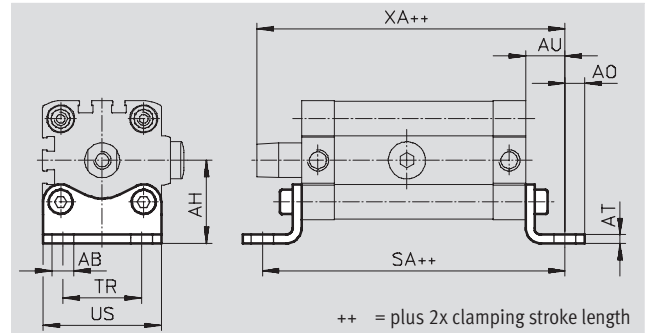

Dimensions and ordering data													
For \varnothing	AB \varnothing H14	AH	AO	AT	AU	SA	TR	US	XA	CRC ¹⁾	Weight [g]	Part No.	Type
[mm]													
12	5.8	21	5	3	13	86.6	16	26	84.5	2	25	537 237	HNA-12
16		22	4.75			88.5	18	27.5	86.4	2	30	537 238	HNA-16
20	7	27	6.25	4	16	111.5	22	34.5	111.9	2	50	537 239	HNA-20
25		29				114.5	26	38.5	114.9	2	55	537 240	HNA-25
32		33.5				7	133	32	46	137.4	2	70	537 241
40	10	38	9	5	21	138.5	36	54	140.9	2	90	537 242	HNA-40
50		45	8			159.5	45	64	159.7	2	160	537 243	HNA-50
63		50				166.9	50	75	166.7	2	180	537 244	HNA-63

1) Corrosion resistance class 2 according to Festo standard 940 070

Components requiring moderate corrosion resistance. Externally visible parts with primarily decorative surface requirements which are in direct contact with a surrounding industrial atmosphere or media such as cooling or lubricating agents

- - Note
Foot mounting HNA can only be used with variant K11-R8 from \varnothing 40 upward.

Linear/swivel clamps CLR

Accessories



Flange mounting FNC

Material:
Galvanised steel
Free of copper, PTFE and silicone

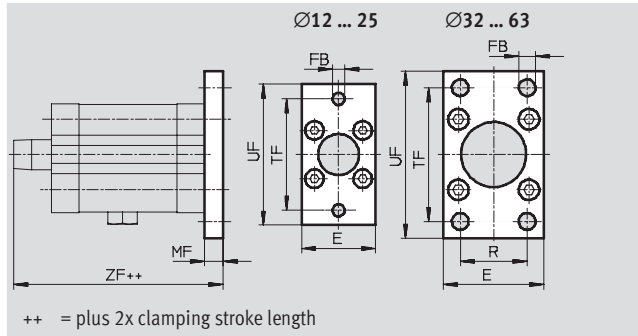

Dimensions and ordering data											
For Ø	E	FB	MF	R	TF	UF	ZF	CRC ¹⁾	Weight	Part No.	Type
[mm]		Ø H13							[g]		
12	28	5.5	8	-	40	50	79.5	2	80	537 245	FNC-12
16	29				43	55	81.4	2	90	537 246	FNC-16
20	36	6.6			55	70	103.9	2	145	537 247	FNC-20
25	40				60	76	106.9	2	170	537 248	FNC-25
32	45	7	10	32	64	80	131.4	2	240	174 376	FNC-32
40	54	9		36	72	90	132.9	2	280	174 377	FNC-40
50	65		12	45	90	110	150.7	2	520	174 378	FNC-50
63	75			50	100	120	157.7	2	690	174 379	FNC-63

1) Corrosion resistance class 2 according to Festo standard 940 070
Components requiring moderate corrosion resistance. Externally visible parts with primarily decorative surface requirements which are in direct contact with a surrounding industrial atmosphere or media such as cooling or lubricating agents

Clamping finger CLR-...-FS

Materials:
Clamp arm:
12 ... 40: Anodised aluminium
50 ... 63: High-alloy stainless steel
Fixing screw, clamping screw,
lock nut: Galvanised steel
Protective cap: Neoprene

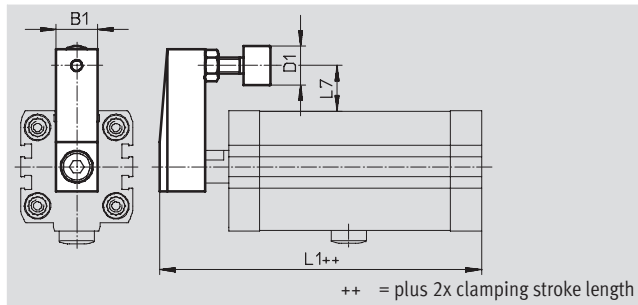





For Ø	B1	D1	L1		L7	Part No.	Type
			Basic version	+1,1/-1,2 K11-R8			
[mm]		Ø					
12	10	11	76.5	-	11.8	535 551	CLR-12-FS
16	11		79.4		12.25	535 552	CLR-16-FS
20	16	15	104.4		17.5	535 553	CLR-20/25-FS
25			107.4	115.5	15.5		
32	20	19	133.3	141.4	25.75	535 554	CLR-32/40-FS
40			134.8	142.9	22		
50	25	24	153.2	160.85	32.5	535 555	CLR-50/63-FS
63			160.2	167.85	27.5		

Linear/swivel clamps CLR

Accessories



Ordering data – One-way flow control valves				Technical data → Volume 2			
	Connection		Material	Part No.	Type		
	Thread	For tubing O.D. [mm]					
For exhaust air							
	M5	3	Metal design	193 137	GRLA-M5-QS-3-D		
		4		193 138	GRLA-M5-QS-4-D		
		6		193 139	GRLA-M5-QS-6-D		
	G1/8	3		193 142	GRLA-1/8-QS-3-D		
		4		193 143	GRLA-1/8-QS-4-D		
		6		193 144	GRLA-1/8-QS-6-D		
		8		193 145	GRLA-1/8-QS-8-D		
				G1/8	4	195 597	GRLA-F-1/8-QS-4-D
					6	195 598	GRLA-F-1/8-QS-6-D
8	195 599		GRLA-F-1/8-QS-8-D				
	G1/8	6	162 965	GRLA-1/8-QS-6-RS-B			
		8	162 966	GRLA-1/8-QS-8-RS-B			
For supply air							
	M5	3	Metal design	193 153	GRLZ-M5-QS-3-D		
		4		193 154	GRLZ-M5-QS-4-D		
		6		193 155	GRLZ-M5-QS-6-D		
	G1/8	3		193 156	GRLZ-1/8-QS-3-D		
		4		193 157	GRLZ-1/8-QS-4-D		
		6		193 158	GRLZ-1/8-QS-6-D		
		8		193 159	GRLZ-1/8-QS-8-D		

Ordering data – One-way flow control valves				Technical data → Volume 2	
	Connection		Material	Part No.	Type
	Thread ¹⁾	For tubing I.D. [mm]			
For exhaust air					
	M5	3	Metal design	151 161	GRLA-M5-PK-3-B
		4		151 162	GRLA-M5-PK-4-B
		6		151 166	GRLA-1/8-PK-3-B
	G1/8	3		151 167	GRLA-1/8-PK-4-B
		4		151 168	GRLA-1/8-PK-6-B
		6			



1) Union nut for barbed fitting only for G1/8 threads



Ordering data – Compressed air tubing			Technical data → Volume 3	
	Flame-retardant	Material		
	Standard O.D. tubing	For use in the immediate vicinity of welding applications	Polyurethane	PUN-V0

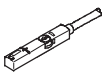

Linear/swivel clamps CLR

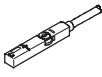
Accessories

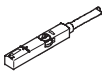
FESTO

Ordering data – Proximity sensors for T-slot, magneto-resistive					Technical data → www.festo.com/catalogue/sm	
	Type of mounting	Switch output	Electrical connection	Cable length [m]	Part No.	Type
N/O contact						
	Insertable in the slot from above, flush with cylinder profile	PNP	Cable, 3-wire	2.5	543 867	SMT-8M-PS-24V-K-2,5-OE
			Plug M8x1, 3-pin	0.3	543 866	SMT-8M-PS-24V-K-0,3-M8D
			Plug M12x1, 3-pin	0.3	543 869	SMT-8M-PS-24V-K-0,3-M12
		NPN	Cable, 3-wire	2.5	543 870	SMT-8M-NS-24V-K-2,5-OE
Plug M8x1, 3-pin	0.3		543 871	SMT-8M-NS-24V-K-0,3-M8D		
	Insertable in the slot lengthwise, flush with the cylinder profile	PNP	Cable, 3-wire	2.5	175 436	SMT-8-PS-K-LED-24-B
			Plug M8x1, 3-pin	0.3	175 484	SMT-8-PS-S-LED-24-B
N/C contact						
	Insertable in the slot from above, flush with cylinder profile	PNP	Cable, 3-wire	7.5	543 873	SMT-8M-PO-24V-K7,5-OE

Ordering data – Proximity sensors for T-slot, magnetic reed					Technical data → www.festo.com/catalogue/sm	
	Type of mounting	Switch output	Electrical connection	Cable length [m]	Part No.	Type
N/O contact						
	Insertable in the slot from above, flush with cylinder profile	Contacting	Cable, 3-wire	2.5	543 862	SME-8M-DS-24V-K-2,5-OE
				5.0	543 863	SME-8M-DS-24V-K-5,0-OE
			Cable, 3-wire	2.5	543 872	SME-8M-ZS-24V-K-2,5-OE
			Plug M8x1, 3-pin	0.3	543 861	SME-8M-DS-24V-K-0,3-M8D
	Insertable in the slot lengthwise, flush with the cylinder profile	Contacting	Cable, 3-wire	2.5	150 855	SME-8-K-LED-24
			Plug M8x1, 3-pin	0.3	150 857	SME-8-S-LED-24
N/C contact						
	Insertable in the slot lengthwise, flush with the cylinder profile	Contacting	Cable, 3-wire	7.5	160 251	SME-8-O-K-LED-24

Ordering data – Connecting cables				Technical data → www.festo.com/catalogue/nebu	
	Electrical connection, left	Electrical connection, right	Cable length [m]	Part No.	Type
	Straight socket, M8x1, 3-pin	Cable, open end, 3-wire	2.5	541 333	NEBU-M8G3-K-2.5-LE3
			5	541 334	NEBU-M8G3-K-5-LE3
	Straight socket, M12x1, 5-pin	Cable, open end, 3-wire	2.5	541 363	NEBU-M12G5-K-2.5-LE3
			5	541 364	NEBU-M12G5-K-5-LE3
	Angled socket, M8x1, 3-pin	Cable, open end, 3-wire	2.5	541 338	NEBU-M8W3-K-2.5-LE3
			5	541 341	NEBU-M8W3-K-5-LE3
	Angled socket, M12x1, 5-pin	Cable, open end, 3-wire	2.5	541 367	NEBU-M12W5-K-2.5-LE3
			5	541 370	NEBU-M12W5-K-5-LE3

Ordering data – Slot cover for T-slot				
	Mounting	Length	Part No.	Type
	Insertable from above	2x 0.5 m	151 680	ABP-5-S

Special-function drives
Power clamps

5.5