

# Manually Actuated Micro Valves

3/2 - 3 Way, 2 Position Valves, Directly Actuated, Barbed Fittings for PU - 1/8 or 3 mm Tubing

## Micro Valves

Spring Return

Type S-3-PK-3-B

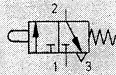

Type SO-3-PK-3-B

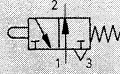

The external dimensions of these valves meet the specifications of DIN 41635 form A.

The switching point is pressure-dependent and varies up to 0.03 in / 0.8 mm in the pressure range from 0 to 120 psi / 0 to 8 bar.

The maximum by which the switching point may be exceeded is 0.02 in / 0.5 mm.

The valve should not be used as a fixed stop.

The valve can only be actuated at right angles to the axis of the stem. If the angle deviates by  $\pm 5^\circ$ , valve actuators must be used.

**Optional Actuators:**  
(Order separately)

**Push-Button**

Type AT-06-B



**Toggle Switch**

Type AH-06-B



Complete with Mounting Screws and Nuts

Example: Type S-3-PK-3-B

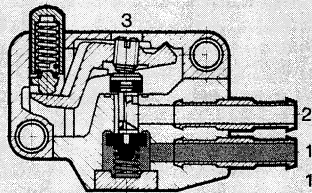

1 (P) = Supply  
2 (A) = Outlet  
3 (R) = Exhaust

Type S-3-PK-3-B

SO-3-PK-3-B

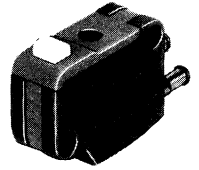
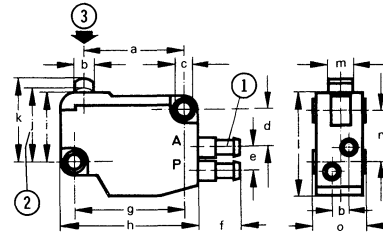

Type AT-06-B

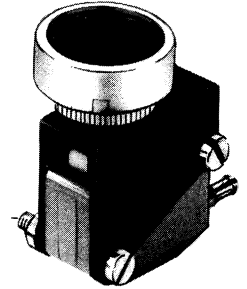
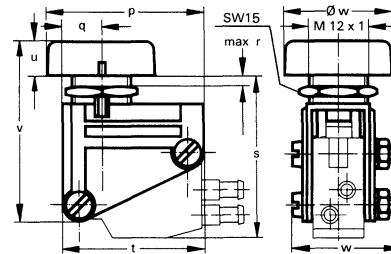

Type AH-06-B

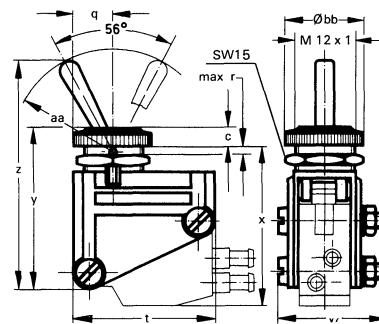

### Dimensions

a	0.80 in / 20.2 mm	l	0.81 in / 20.4 mm
b	0.16 in / 4 mm	m	0.20 in / 5 mm
c	0.14 in / 3.4 mm	n	0.40 in / 10.3 mm
d	0.30 in / 7.5 mm	o	0.42 in / 10.4 mm
e	0.19 in / 4.8 mm	p	1.24 in / 31.6 mm
f	0.33 in / 8.5 mm	q	0.31 in / 8 mm
g	0.89 in / 22.2 mm	r	0.14 in / 3.5 mm
h	1.08 in / 27.8 mm	s	1.28 in / 32.6 mm
i	0.53 in / 13.5 mm	t	1.12 in / 28.6 mm
j	0.57 in / 14.4 mm	u	0.30 in / 7.6 mm
k	0.65 in / 16.5 mm	v	1.44 in / 36.5 mm

- ① Barbed fittings 1/8 in / 3 mm tubing
  - ② Actuation point (min)
  - ③ Direction of actuation
- SW = wrench size, mm

w	0.87 in / 22 mm
x	1.29 in / 32.8 mm
y	1.28 in / 32.5 mm
z	1.81 in / 46 mm
aa	0.82 in / 20.7 mm
bb	0.63 in / 16 mm

Order Number	Valve	7843 S-3-PK-3-B	10403 SO-3-PK-3-B		
	Actuators			10398 AT-06-B	10399 AH-06-B
Medium		Compressed air (filtered, lubricated or unlubricated) or vacuum†			
Mounting		2 through holes in housing			
Connection		Barbed fittings for 3 mm tubing			
Orifice Size		0.07 in / 1.8 mm			
C <sub>v</sub> Factor	(P → A)	0.06 C <sub>v</sub> / 60 l/min			
Pressure Range		28.5 in Hg to 120 psi / -0.95 to +8 bar			
Operating Force at 90 psi / 6 bar Supply*		1.35 lbf / 6N		2.25 lbf / 10 N	
Design		Seat valve, directly actuated, spring return			
Material		Polymer, brass		Polymer	
Weight		0.015 lb / 0.007 kg		0.055 lb / 0.025 kg	0.066 lb / 0.030 kg

\* 14 to 140°F / -10 to +60°C

† Vacuum connection at 1 (P)