

Compact cylinders AEU/AEVUZ - Inch Series





- Piston Ø 1/2" to 4"
- Stroke lengths up to 1"
- Single-acting versions
- Compact design – less space required
- Numerous options
- Repairable

Product range overview											
Function	Version	Piston Ø [in]	Stroke [in]	Force [lbf]	Variants						
					A	P	A	S2	S6	S20	S26
Single-acting	Basic version										
	AEVU, pushing	1/2, 5/8, 3/4, 1, 1-1/4, 1-5/8, 2, 2-1/2, 3, 4	0.04 ... 1.0	15.3 ... 1,060	■	■	■	■	■	■	-
	AEVUZ, pulling	1/2, 5/8, 3/4, 1, 1-1/4, 1-5/8, 2, 2-1/2, 3, 4	0.04 ... 1.0	15.3 ... 1,060	■	■	■	-	■	■	-

Variants											
A	Male thread	A	Magnet for position sensing	S6	Heat-resistant seals up to 302°F	S20	Through, hollow piston rod				
P	Flexible cushioning rings at both ends	S2	Through piston rod								

Compact cylinders AEVU/AEVUZ - Inch Series

Product range overview

Function	Version	Type	Piston Ø [in]	Standard stroke [in]	Variable stroke [in]	Magnet for position sensing A
Single-acting	Basic version					
		AEVU Piston rod at one end, pushing	1/2	1/4, 1/2	0.04 ... 0.5	■
			5/8, 3/4, 1, 1-1/4, 1-5/8	1/4, 1/2, 3/4, 1	0.04 ... 1	
			2, 2-1/2, 3, 4	1/2, 3/4, 1	0.04 ... 1	
		AEVUZ Piston rod at one end, pulling	1/2	1/4, 1/2	0.04 ... 1	■
			5/8, 3/4, 1, 1-1/4, 1-5/8	1/4, 1/2, 3/4, 1	0.04 ... 1	
2, 2-1/2, 3, 4			1/2, 3/4, 1	0.04 ... 1		

Compact cylinders AEU/AEUVZ - Inch Series

Product range overview

Type	Piston rod		Through piston rod S2	Through hollow piston rod S20	Heat resistant seals up to 302 °F S6
	with female thread	with male thread			
Basic version					
AEVU Piston rod at one end, pushing	■	■	■	■	■
AEVUZ Piston rod at one end, pulling	■	■	■	■	■

Compact cylinders AEU/AEUZ - Inch Series

Technical data – Single-acting, basic version

FESTO

Pushing – AEU

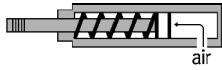

- Through piston rod (S2)
- Through, hollow piston rod (S20)
- Heat resistant seals (S6)

Pulling – AEUZ

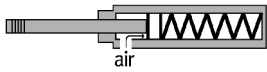

⌀ - Diameter
1/2 ... 4 inch

— Stroke length
0.4 ... 1 inch

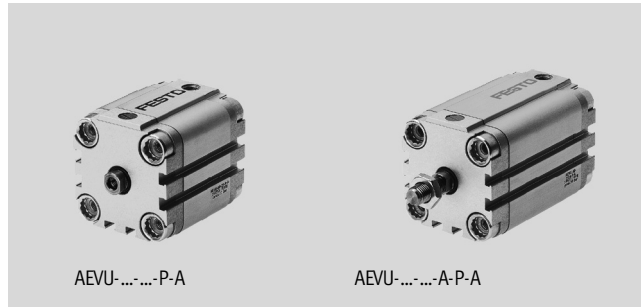

AEU-...-P-A

AEU-...-P-A

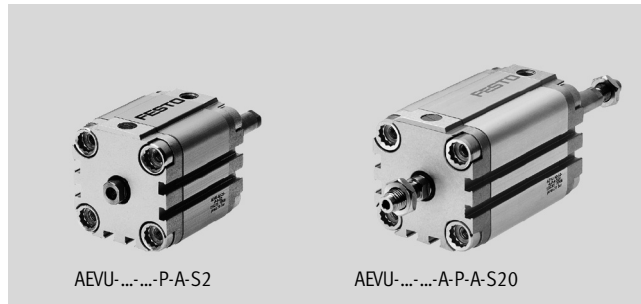

AEU-...-P-A-S2

AEU-...-P-A-S20

Design										
Piston Ø	1/2	5/8	3/4	1	1-1/4	1-5/8	2	2-1/2	3	4
Pneumatic connection	10-32 UNF				1/8" NPT					1/4" NPT
End of piston rod	Female thread	4-48 UNF-2B	8-36 UNF-2B	10-32 UNF-2B	1/4-28 UNF-2B	5/16-24 UNF-2B	3/8-24 UNF-2B	1/2-20 UNF-2B		
	Male thread	10-32 UNF-2A	5/16-24 UNF-2A	3/8-24 UNF-2A			1/2-20 UNF-2A	5/8-18 UNF-2A	3/4-16 UNF-2A	
Operating medium	Filtered compressed air, lubricated or unlubricated									
Constructional design	Piston									
	Piston rod									
Cushioning	Flexible cushioning rings at both ends									
Magnet for position sensing ¹⁾	Standard									

1) Position sensing via magnetic proximity sensor (ordered separately, see accessories).

Operating pressure [psi]										
Piston Ø	1/2	5/8	3/4	1	1-1/4	1-5/8	2	2-1/2	3	4
Pushing variant AEU										
Piston rod at one end	22 ... 147	19 ... 147	15 ... 147	12 ... 147			9 ... 147			
Through piston rod S2/S20	25 ... 147	22 ... 147	21 ... 147	18 ... 147			15 ... 147			
Pulling variant AEUZ										
Piston rod at one end	22 ... 147	19 ... 147	15 ... 147	12 ... 147						

Ambient conditions		
Variant	Basic version	
Ambient temperature ¹⁾ [°F]	-4 ... +176	32 ... +302
Corrosion resistance class CRC ²⁾	2	2

1) Note operating range of proximity sensors.

2) Corrosion resistance class 2 according to Festo standard 940 070

Components with moderate corrosion resistance for use in normal industrial environments subjected to contact with coolants or lubricating agents.

Compact cylinders AEU/AEVUZ - Inch Series

Technical data – Single-acting, basic version

Forces [lbf]										
Piston Ø	1/2	5/8	3/4	1	1-1/4	1-5/8	2	2-1/2	3	4
Pushing variant AEU										
Theoretical force at 90 psi, extending	15.3	27.2	42.3	66.4	108.7	169.7	265	420.8	678.6	1060.2
S2/S20	15.3	27.2	42.3	66.4	108.7	169.7	265	420.8	678.6	1060.2
Pulling variant AEUZ										
Theoretical force at 90 psi, extending	15.3	27.2	42.3	66.4	108.7	169.7	265	420.8	678.6	1060.2

Spring return force F as a function of the stroke l

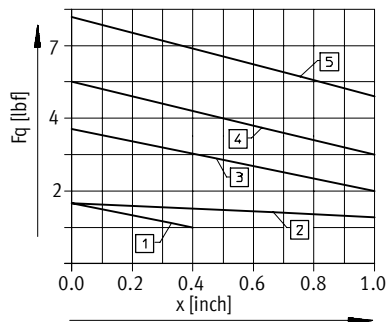

- 1 AEU/AEVUZ-1/2
- 2 AEU/AEVUZ-5/8
- 3 AEU/AEVUZ-3/4
- 4 AEU/AEVUZ-1
- 5 AEU/AEVUZ-1-1/4

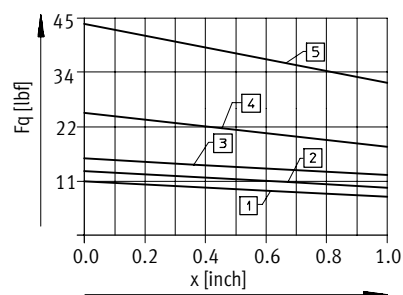

- 1 AEU/AEVUZ-1-5/8
- 2 AEU/AEVUZ-2
- 3 AEU/AEVUZ-2-1/2
- 4 AEU/AEVUZ-3
- 5 AEU/AEVUZ-4

Mass [lb]										
Piston Ø	1/2	5/8	3/4	1	1-1/4	1-5/8	2	2-1/2	3	4
Product mass with 0 inch stroke	0.19	0.19	0.33	0.40	0.66	0.96	1.24	2.34	3.91	6.17
Additional mass per 1 inch stroke	0.08	0.08	0.13	0.16	0.23	0.33	0.41	0.60	0.94	0.99
Moving load with 0 inch stroke (m_{piston})	0.02	0.03	0.04	0.06	0.11	0.14	0.25	0.29	0.68	1.36
Additional load per 1 inch stroke (m_{piston})	0.01	0.03	0.03	0.03	0.05	0.05	0.09	0.09	0.14	0.14

Compact cylinders AEVU/AEVUZ - Inch Series

Technical data – Single-acting, basic version

Materials

Sectional view

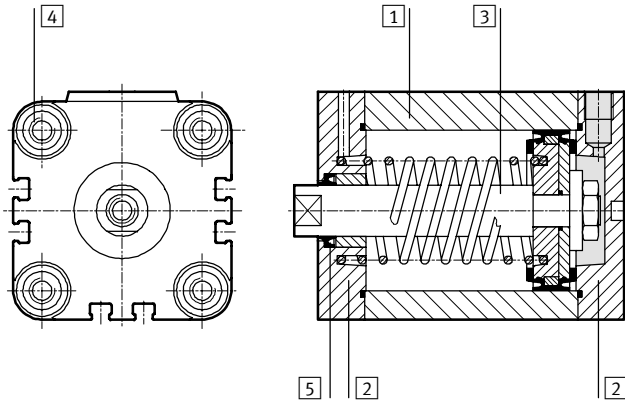

Variants	Basic version	S6
1 Cylinder barrel	Wrought aluminum alloy	Wrought aluminum alloy
2 End cap	Wrought aluminum alloy	Wrought aluminum alloy
3 Piston rod	∅ 1/2 ... 1-1/4	High-alloy stainless steel
	∅ 1-5/8 ... 4	High-alloy steel
4 Flange screws	∅ 1/2 ... 5/8	High-alloy stainless steel
	∅ 3/4 ... 4	Tempered steel
5 Dynamic seals	Polyurethane	Fluorocarbon rubber

Dimensions – Basic cylinder

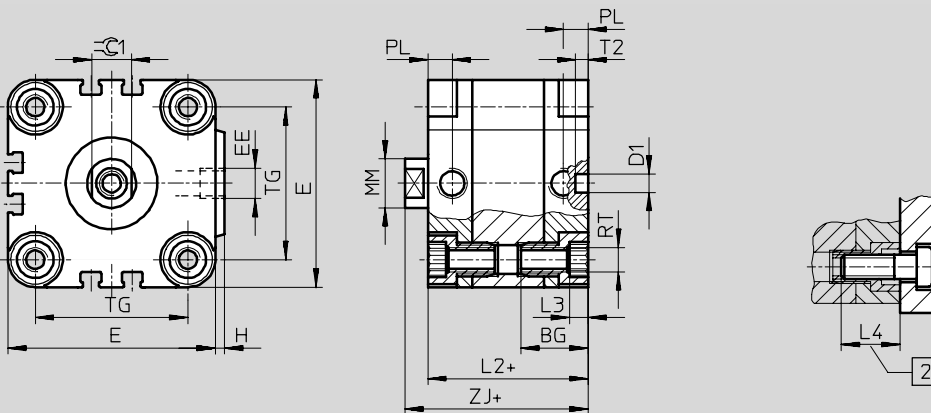

Note

To attach cylinder ∅ 1/2 and 5/8 inch from above, use only 2 screws diagonally or non-magnetic screws.

+ = plus stroke length

2 Minimum screw-in depth

∅	BG	D1 ∅	E	EE	H	L2	L3	L4	MM ∅	PL	RT	T2	TG	ZJ	≅C1 [mm]
1/2	0.7	0.2	1.1	10-32 UNF	0.04	1.5	0.1	0.6	0.2	0.3	M4	0.2	0.7	1.7	5
5/8	0.7	0.2	1.1	10-32 UNF	0.04	1.5	0.1	0.6	0.3	0.3	M4	0.2	0.7	1.7	7
3/4	0.7	0.2	1.4	10-32 UNF	0.06	1.5	0.2	0.7	0.4	0.3	M5	0.2	0.9	1.7	9
1	0.7	0.2	1.6	10-32 UNF	0.06	1.6	0.2	0.7	0.4	0.3	M5	0.2	1.0	1.8	9
1-1/4	0.8	0.2	2.0	1/8" NPT	0.08	1.8	0.2	0.8	0.5	0.3	M6	0.2	1.3	2.0	10
1-5/8	0.8	0.2	2.4	1/8" NPT	0.10	1.8	0.2	0.8	0.5	0.3	M6	0.2	1.7	2.0	10
2	0.9	0.2	2.7	1/8" NPT	0.12	1.8	0.2	0.8	0.6	0.3	M8	0.2	2.0	2.1	13
2-1/2	1.0	0.3	3.4	1/8" NPT	0.16	2.0	0.3	1.0	0.6	0.3	M10	0.2	2.4	2.3	13
3	1.1	0.3	4.2	1/8" NPT	0.16	2.2	0.3	1.0	0.8	0.3	M10	0.2	3.2	2.5	17
4	1.3	0.3	5.0	1/4" NPT	0.20	2.6	0.3	1.0	1.0	0.4	M10	0.2	4.1	3.0	22

Dimensions are in inches, unless otherwise noted.

Compact cylinders AEU/AEVUZ - Inch Series

Technical data – Single-acting, basic version

Dimensions – Pushing variants, AEU

Basic version

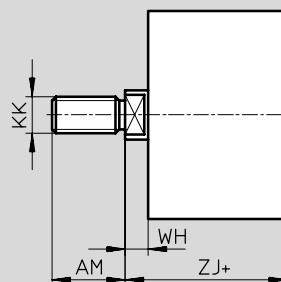
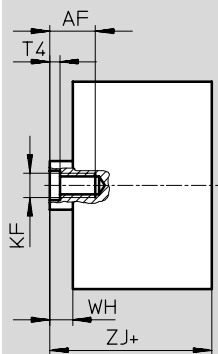

S2 – Through piston rod

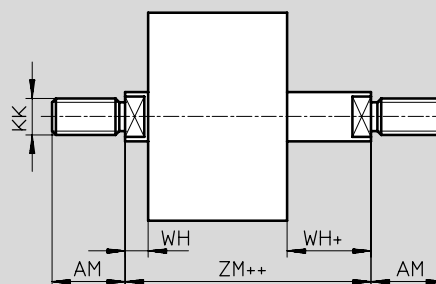
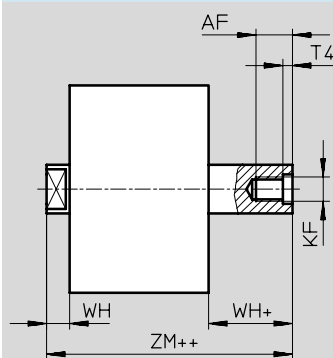

S20 – Through, hollow piston rod

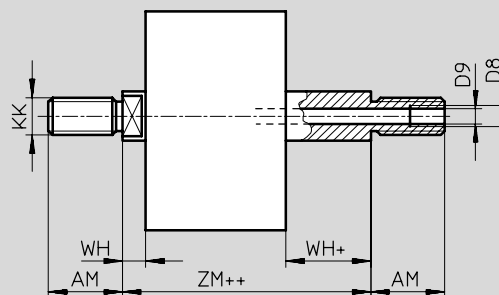

+ = plus stroke length
++ = plus 2x stroke length

∅ [in]	AF	AM	D8	D9 ∅	KF	KK	T4	WH	ZJ	ZM
1/2	0.3	0.6	-	0.09	4-48 UNF-2B	10-32 UNF-2A	0.06	0.18	1.7	1.9
5/8	0.4	0.8	-	0.13	8-36 UNF-2B	5/16-24 UNF-2A	0.06	0.18	1.7	1.9
3/4 ²⁾	0.5	0.9	-	0.15	10-32 UNF-2B	3/8-24 UNF-2A	0.08	0.18	1.7	1.9
1 ²⁾	0.5	0.9	-	0.15	10-32 UNF-2B	3/8-24 UNF-2A	0.08	0.22	1.8	2.0
1-1/4 ²⁾	0.6	0.9	-	0.18	1/4-28 UNF-2B	3/8-24 UNF-2A	0.10	0.24	2.0	2.2
1-5/8 ²⁾	0.6	0.9	-	0.18	1/4-28 UNF-2B	3/8-24 UNF-2A	0.10	0.26	2.0	2.3
2 ²⁾	0.6	0.9	-	0.24	5/16-24 UNF-2B	1/2-20 UNF-2A	0.13	0.30	2.1	2.4
2-1/2 ²⁾	0.6	0.9	-	0.24	5/16-24 UNF-2B	1/2-20 UNF-2A	0.13	0.30	2.3	2.6
3 ²⁾	0.8 ¹⁾	1.3	1/8" NPT	0.31	3/8-24 UNF-2B	5/8-18 UNF-2A	0.19	0.31	2.5	2.8
4 ²⁾	0.9 ¹⁾	1.6	1/4" NPT	0.46	1/2-20 UNF-2B	3/4-16 UNF-2A	0.24	0.39	3.0	3.4

1) With a stroke < 0.2 inch, the maximum screw-in depth is reduced by 0.2 inch.
2) Nut for piston rod thread included in scope of delivery.

Dimensions are in inches, unless otherwise noted.

Compact cylinders AEVU/AEVUZ - Inch Series

Technical data – Single-acting, basic version

Dimensions – Pulling variants, AEVUZ

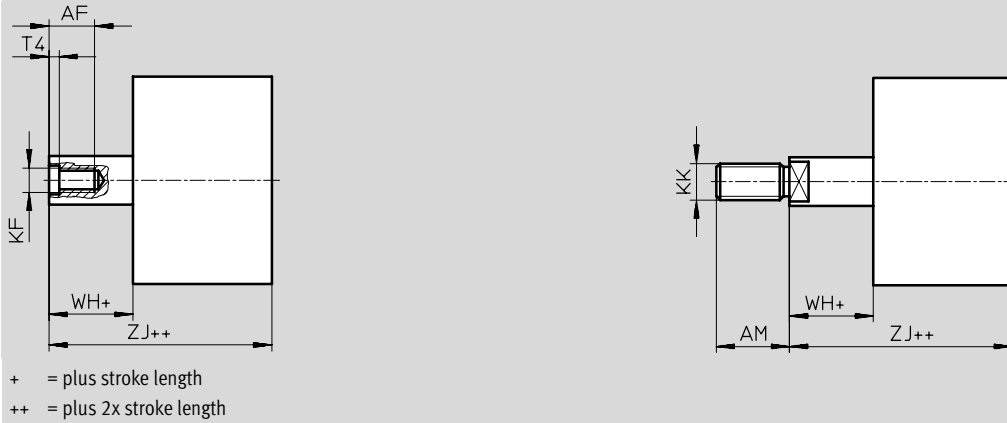

∅ [in]	AF	AM	KF	KK	T4	WH	ZJ
1/2	0.3	0.6	4-48 UNF-2B	10-32 UNF-2A	0.06	0.18	1.67
5/8	0.4	0.8	8-32 UNF-2B	5/16-24 UNF-2A	0.06	0.18	1.67
3/4 ¹⁾	0.5	0.9	10-32 UNF-2B	3/8-24 UNF-2A	0.08	0.18	1.67
1 ¹⁾	0.5	0.9	10-32 UNF-2B	3/8-24 UNF-2A	0.08	0.22	1.77
1-1/4 ¹⁾	0.6	0.9	1/4-28 UNF-2B	3/8-24 UNF-2A	0.10	0.24	1.99
1-5/8 ¹⁾	0.6	0.9	1/4-28 UNF-2B	3/8-24 UNF-2A	0.10	0.26	2.05
2 ¹⁾	0.6	0.9	5/16-24 UNF-2B	1/2-20 UNF-2A	0.13	0.30	2.09
2-1/2 ¹⁾	0.6	0.9	5/16-24 UNF-2B	1/2-20 UNF-2A	0.13	0.30	2.26
3 ¹⁾	0.8	1.3	3/8-24 UNF-2B	5/8-18 UNF-2A	0.19	0.31	2.52
4 ¹⁾	0.9	1.6	1/2-20 UNF-2B	3/4-16 UNF-2A	0.24	0.39	3.01

1) Nut for piston rod thread included in scope of delivery.

Dimensions are in inches, unless otherwise noted.

Compact cylinders AEU/AEUVZ - Inch Series

Ordering Data

M Mandatory data					O Options	
Function	Piston Ø	Stroke	Cushioning	Magnet for position sensing	Type of piston rod	Temperature Resistant
AEVU AEUVZ	1/2 5/8 3/4 1 1 1/4 1 5/8 2 2 1/2 3 4	0.04 ... 1	P	A	S2 S20	S6
AEVU	- 1	- 1	- P	- A	- S6	

Ordering table															
Size	1/2	5/8	3/4	1	1 1/4	1 5/8	2	2 1/2	3	4	Conditions	Code	Enter code		
M	Function	Single-acting, pushing										-	AEVU		
		Single-acting, pulling										-	AEUVZ		
	Piston Ø [in]	1/2	5/8	3/4	1	1 1/4	1 5/8	2	2 1/2	3	4	-	-...		
	Stroke [in]	0.04 ... 1/2	0.04 ... 1										-		-...
	Cushioning	Flexible cushioning rings at both ends										-	-P		-P
Magnet for position sensing	For use with magnetic proximity sensor										-	-A	-A		
O	Type of piston rod	Through piston rod										-	-S2		
		Through, hollow piston rod										-	-S20		
	Temperature resistant	Heat-resistant seals up to max. 302 °F										1	-S6		

1 Not in combination with S2 or S20

Transfer order code

- - - **P** - **A** -

Compact cylinders AEVU/AEVUZ - Inch Series

Accessories overview



Piston \varnothing 1/2 ... 4 inch

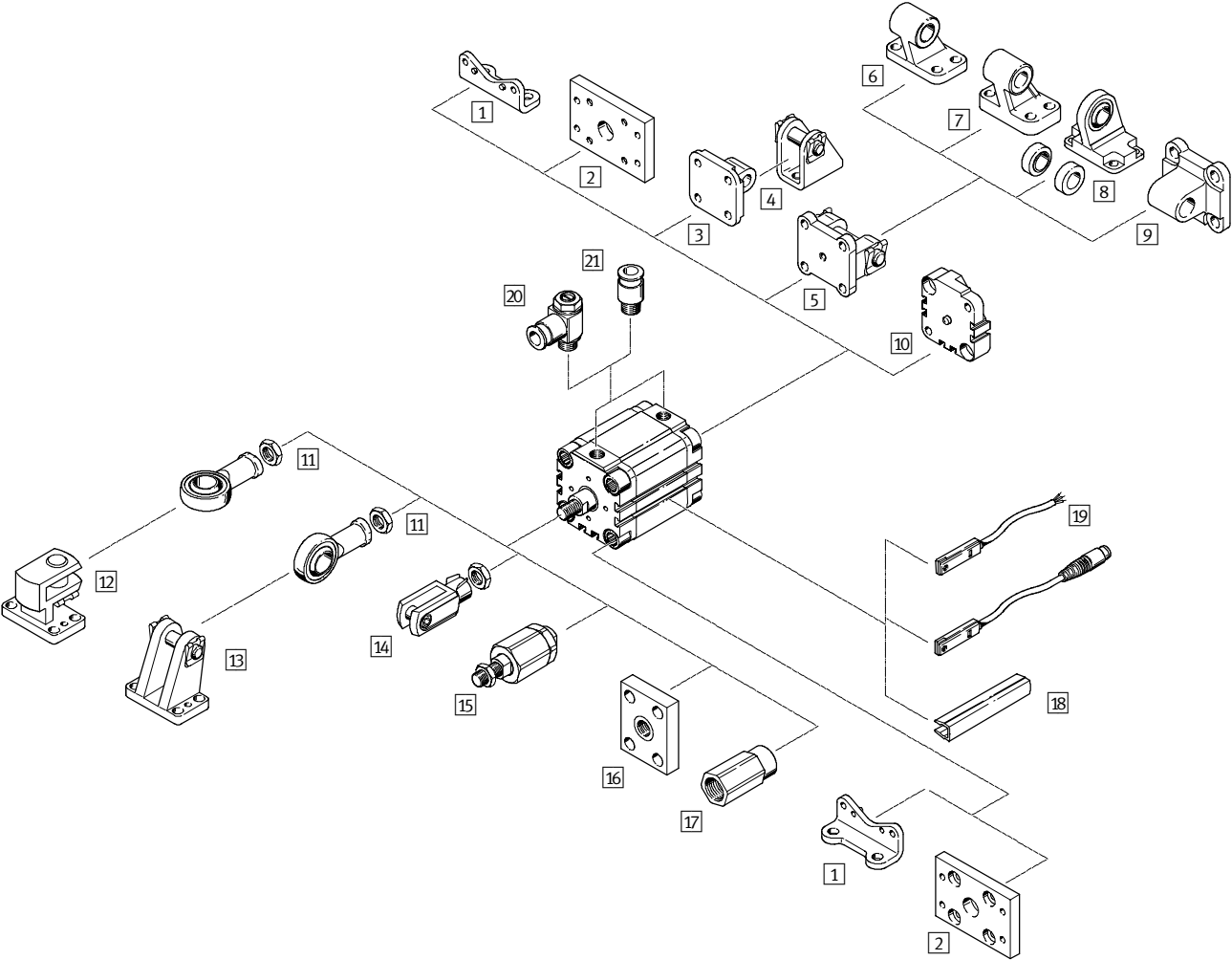

Compact cylinders AEU/AEVUZ - Inch Series

Accessories overview

Mounting attachments and accessories				
	Description	AEV/AEVUZ		
		Basic	S2/S20	
1	Foot mounting HUA	For bearing and end cap	■	■
2	Flange mounting FUA	For bearing or end cap	■	■
3	Swivel flange SUA for \varnothing 1/2 ... 1	For end cap	■	-
4	Clevis foot LBN	-	■	-
5	Swivel flange SUA for \varnothing 1-1/4 ... 4	For end cap	■	-
6	Clevis foot LN	-	■	-
7	Clevis foot LNG	-	■	-
8	Clevis foot LSN	With spherical bearing	■	-
9	Swivel flange SNCL	-	■	-
10	Adapter kit DPVU	For connecting two cylinders with identical piston \varnothing to form a multi-position cylinder	■	-
11	Rod eye SGS	With spherical bearing	■	■
12	Clevis foot, lateral LQG	-	■	■
13	Clevis foot LBG	-	■	■
14	Rod clevis SG	Permits a swivelling movement of the cylinder in one plane	■	■
15	Self-aligning rod coupler FK	For compensating radial and angular deviations	■	■
16	Coupling piece KSZ	For cylinders with non-rotating piston rod for compensating radial deviations	-	-
17	Adapter AD	For vacuum generator	-	■ S20
18	Slot cover ABP-5-S	For protecting the sensor cable and keeping dirt out of the sensor slots	■	■
19	Proximity sensor SME/SMT-8	Can be integrated in the cylinder profile barrel	■	■
20	One-way flow control valve GRLA/GRLZ	For speed regulation	■	■
21	Push-in fitting QS	For connecting compressed air tubing with standard O.D.	■	■

Compact cylinders AEVU/AEVUZ - Inch Series

Accessories

FESTO

Foot mounting HUA

for piston \varnothing 1/2 ... 4 inch

Material:

HUA/HNC: Galvanized steel

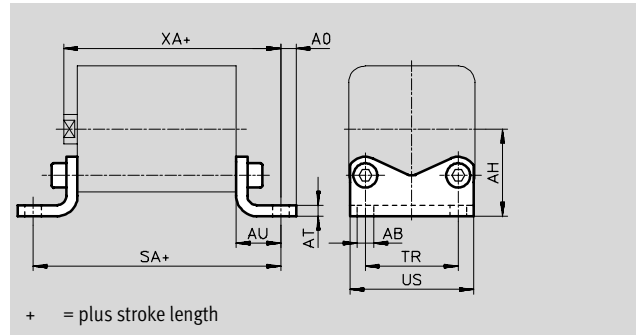

Dimensions									
For \varnothing	AB \varnothing	AH	AO	AT	AU	SA	TR	US	XA
1/2, 5/8	0.22	0.9	0.2	0.1	0.5	2.5	0.7	1.1	2.2
3/4	0.26	1.1	0.2	0.2	0.6	2.8	0.9	1.3	2.3
1	0.26	1.1	0.2	0.2	0.6	2.8	1.0	1.5	2.4
1-1/4	0.26	1.3	0.3	0.2	0.7	3.2	1.3	1.9	2.7
1-5/8	0.35	1.6	0.3	0.2	0.8	3.4	1.7	2.3	2.8
2	0.35	1.9	0.3	0.2	0.9	3.7	2.0	2.6	3.0
2-1/2	0.43	2.2	0.5	0.2	1.1	4.1	2.4	3.3	3.3
3	0.43	2.7	0.5	0.3	1.2	4.6	3.2	4.1	3.7
4	0.53	3.2	0.5	0.3	1.3	5.2	4.1	5.0	4.3

Ordering data				
For \varnothing	Weight [oz]	Basic version		
		CRC ¹⁾	Part No.	Type
1/2, 5/8	1.38	2	157309	HUA-12/16
3/4	2.75	2	157310	HUA-20
1	3.17	2	157311	HUA-25
1-1/4	5.47	2	157312	HUA-32
1-5/8	7.09	2	157313	HUA-40
2	11.08	2	157314	HUA-50
2-1/2	19.40	2	157315	HUA-63
3	29.10	2	157316	HUA-80
4	37.04	2	157317	HUA-100

1) Corrosion resistance class 2 according to Festo standard 940 070
Components with moderate corrosion resistance for use in normal industrial environments subjected to contact with coolants or lubricating agents.

Dimensions are in inches, unless otherwise noted.

Compact cylinders AEVU/AEVUZ - Inch Series

Accessories

Flange mounting FUA
for piston \varnothing 1/2 ... 4 inch

Flange mounting FNC
for piston \varnothing 5 inch
(not illustrated)

Material:

FUA: Clear anodized aluminum

FNC: Galvanized steel

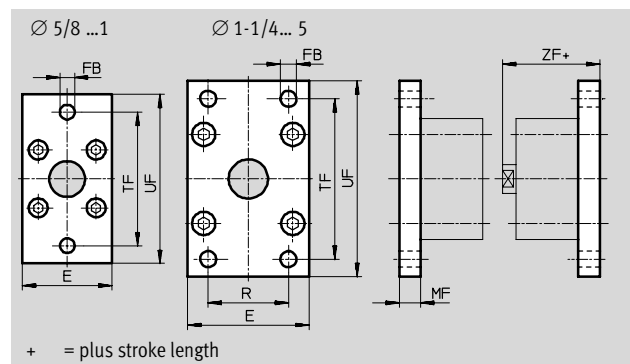
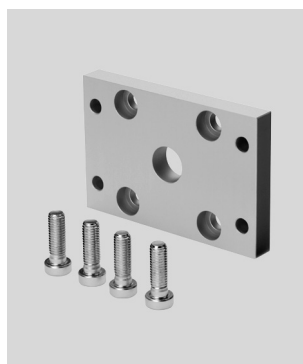

Dimensions and ordering data											
For \varnothing	E	FB \varnothing	MF	R	TF	UF	ZF	CRC ²⁾	Weight [oz]	Part No.	Type
1/2, 5/8	1.1	0.2	0.4	–	1.7	2.2	2.1	2	1.69	157299	FUA-12/16
3/4	1.4	0.3	0.4	–	2.2	2.8	2.1	2	2.54	157300	FUA-20
1	1.6	0.3	0.4	–	2.4	3.0	2.2	2	3.07	157301	FUA-25
1-1/4	2.0	0.3	0.4	1.3	2.6	3.1	2.4	2	4.13	157302	FUA-32
1-5/8	2.4	0.4	0.4	1.4	3.2	4.0	2.4	2	6.35	157303	FUA-40
2	2.7	0.4	0.5	1.8	3.5	4.3	2.6	2	9.38	157304	FUA-50
2-1/2	3.4	0.4	0.6	2.0	4.3	5.1	2.9	2	19.40	157305	FUA-63
3	4.2	0.5	0.6	2.5	5.3	6.3	3.0	2	26.28	157306	FUA-80
4	5.0	0.6	0.6	3.0	6.4	7.5	3.6	2	36.51	157307	FUA-100

1) Free of copper, PTFE and silicone

2) Corrosion resistance class 2 according to Festo standard 940 070

Components with moderate corrosion resistance for use in normal industrial environments subjected to contact with coolants or lubricating agents.

Dimensions are in inches, unless otherwise noted.

Compact cylinders AEVU/AEVUZ - Inch Series

Accessories

FESTO

Swivel flange SUA

for piston \varnothing 1/2 ... 1 inch

Material:

SUA: Anodized aluminum

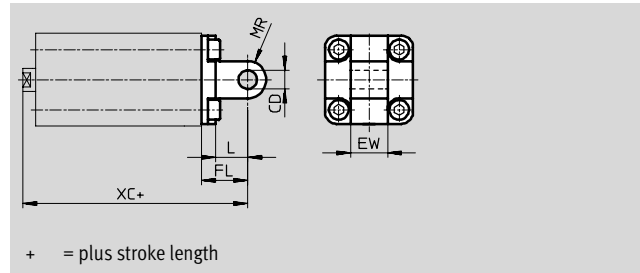

for piston \varnothing 1-1/4 ... 4 inch

Material:

SUA: Anodized aluminum

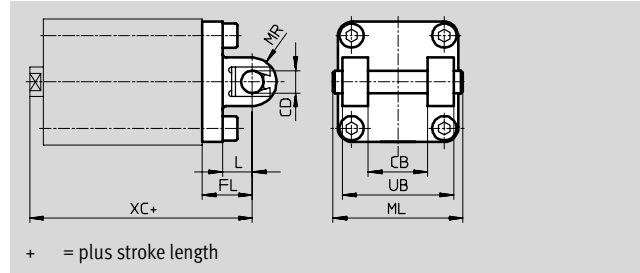

Dimensions									
For \varnothing	CB	CD \varnothing	EW	FL	L	ML	MR	UB	XC
1/2, 5/8	–	0.2	0.5	0.6	0.4	–	0.2	–	2.3
3/4	–	0.3	0.6	0.8	0.6	–	0.3	–	2.5
1	–	0.3	0.6	0.8	0.6	–	0.3	–	2.6
1-1/4	1.0	0.4	–	0.9	0.5	2.1	0.4	1.8	2.9
1-5/8	1.1	0.5	–	1.0	0.6	2.4	0.5	2.0	3.0
2	1.3	0.5	–	1.1	0.6	2.8	0.5	2.4	3.1
2-1/2	1.6	0.6	–	1.3	0.8	3.2	0.6	2.8	3.5
3	2.0	0.6	–	1.4	0.9	4.0	0.6	3.5	3.9
4	2.4	0.8	–	1.6	1.0	5.0	0.8	4.3	4.6

Ordering data			
For \varnothing	Weight [oz]	Basic version	
		Part No.	Type
1/2, 5/8	1.5	157319	SUA-12/16
3/4	2.8	157320	SUA-20
1	3.0	157321	SUA-25
1-1/4	7.3	157322	SUA-32
1-5/8	11.3	157323	SUA-40
2	15.4	157324	SUA-50
2-1/2	26.8	157325	SUA-63
3	42.0	157326	SUA-80
4	67.0	157327	SUA-100

Note
Do not exceed the maximum overall stroke length listed when combining cylinders and swivel flanges.

For \varnothing	Max. stroke length [in]
1/2	2
5/8	2
3/4	2
1	2
1-1/4	4

For \varnothing	Max. stroke length [in]
40	4
50	4
63	4
80	6
100	6

Dimensions are in inches, unless otherwise noted.

Compact cylinders AEVU/AEVUZ - Inch Series

Accessories

Adapter kit DPVU for piston \varnothing 1/2 ... 4 inch

Material:
Aluminum
Free of copper, PTFE and silicone

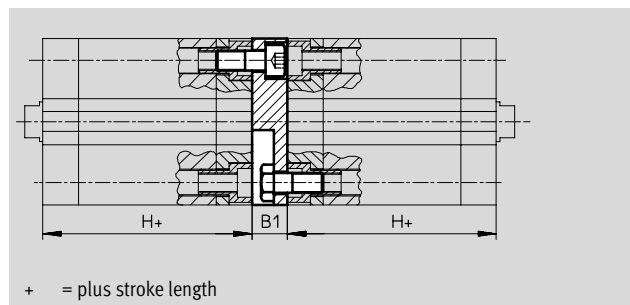

Note
Do not exceed the maximum overall stroke length listed when combining cylinders and the adapter kit.

Dimensions and ordering data							
For \varnothing	B1	H	Max. overall stroke length [in]	CRC ¹⁾	Weight [oz]	Part No.	Type
1/2, 5/8	0.5	1.5	15.7	2	0.78	161194	DPVU-12/16
3/4	0.5	1.5	15.7	2	1.27	161195	DPVU-20
1	0.5	1.6	15.7	2	1.55	161196	DPVU-25
1-1/4	0.6	1.8	23.6	2	3.17	161197	DPVU-32
1-5/8	0.6	1.8	23.6	2	4.83	161198	DPVU-40
2	0.6	1.8	23.6	2	6.24	161199	DPVU-50
2-1/2	0.6	2.0	23.6	2	10.86	161200	DPVU-63
3	0.6	2.2	31.5	2	17.46	161201	DPVU-80
4	0.8	2.6	31.5	2	30.30	161202	DPVU-100

1) Corrosion resistance class 2 according to Festo standard 940 070
Components with moderate corrosion resistance for use in normal industrial environments subjected to contact with coolants or lubricating agents.

Connecting two cylinders with identical piston \varnothing as a 3 or 4-position cylinder

A 3 or 4-position cylinder consists of two separate cylinders whose piston rods advance in opposing directions.

Depending upon actuation and stroke pattern, this type of cylinder can assume up to four positions. In each

case the cylinder is driven precisely against a stop. If one end of the piston rod is fixed, the cylinder barrel

executes the movement. The cylinder must be connected with flexible line connections.

Implementing 3 positions

Two cylinders with identical stroke length must be connected to accomplish this.

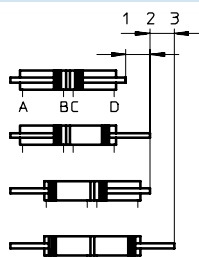

Implementing 4 positions

Two cylinders with different stroke lengths must be connected to accomplish this.

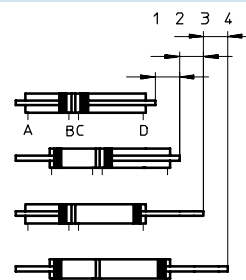

Dimensions are in inches, unless otherwise noted.

Compact cylinders AEU/AEUZ - Inch Series

Accessories

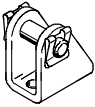
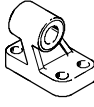
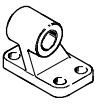
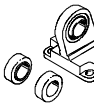
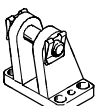
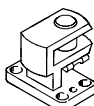
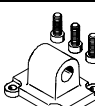

FESTO

Ordering data – Mounting attachments				Ordering data – Mounting attachments			
Designation	For Ø [in]	Part No.	Type	Designation	For Ø [in]	Part No.	Type
Clevis foot LBN				Clevis foot LNG			
	1/2	6058	LBN-12/16		1-1/4	33890	LNG-32
	5/8	6058	LBN-12/16		5/8	33891	LNG-40
	3/4	6059	LBN-20/25		2	33892	LNG-50
	1	6059	LBN-20/25		2-1/2	33893	LNG-63
					3	33894	LNG-80
				4	33895	LNG-100	
Clevis foot LN				Clevis foot LSN			
	1-1/4	5147	LN-32		1-1/4	5561	LSN-32
	1-5/8	5148	LN-40		1-5/8	5562	LSN-40
	2	5149	LN-50		2	5563	LSN-50
	2-1/2	5150	LN-63		2-1/2	5564	LSN-63
	3	5151	LN-80		3	5565	LSN-80
4	5152	LN-100	4	5566	LSN-100		
Clevis foot LBG				Clevis foot, lateral LQG			
	3/4, 1, 1-1/4, 1-5/8	31761	LBG-32		3/4, 1, 1-1/4, 1-5/8	31768	LQG-32
	2, 2-1/2	31762	LBG-40		2, 2-1/2	31769	LQG-40
	3	31763	LBG-50		3	31770	LQG-50
		31764	LBG-63			31771	LQG-63
	4	31765	LBG-80		4	31772	LQG-80
31766		LBG-100	31773	LQG-100			
Swivel flange SNCL							
	1-1/4	174404	SNCL-32				
	1-5/8	174405	SNCL-40				
	2	174406	SNCL-50				
	2-1/2	174407	SNCL-63				
	3	174408	SNCL-80				
4	174409	SNCL-100					

Compact cylinders AEVU/AEVUZ - Inch Series

Accessories

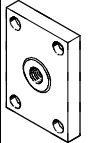

FESTO

Ordering data – Piston rod attachments								
Designation	For Ø [in]	Part No.	Type	Designation	For Ø [in]	Part No.	Type	
Rod eye SGS				Self-aligning rod coupler FK				
	1/2	532694	SGS-10-32		1/2	-		
	5/8							
	3/4	532695	SGS-5/16-24		3/4			
	1	532696	SGS-3/8-24		1	36129		KSZ-3/8-24-UNF
	1-1/4	532696	SGS-3/8-24		1-1/4	36129		KSZ-3/8-24-UNF
	1-5/8	532697	SGS-1/2-20		1-5/8	36130		KSZ-1/2-20-UNF
	2	532698	SGS-5/8-18		2	36131		KSZ-5/8-18-UNF
	2-1/2							
	3	532699	SGS-3/4-16		3	36132		KSZ-3/4-16-UNF
4			4					
Rod clevis SG				Coupling piece KSZ				
	1/2	546552	SG-UNF10-32-B		1/2	532703	FK-10-32	
	5/8							
	3/4	546574	SG-UNF5/16-24-B		3/4	532704	FK-5/16-24	
	1	546540	SG-UNF3/8-24-B		1	532705	FK-3/8-24	
	1-1/4				1-1/4	532705	FK-3/8-24	
	1-5/8	546545	SG-UNF1/2-20-B		1-5/8	532706	FK-1/2-20	
	2	546575	SG-UNF5/8-18-B		2	532707	FK-5/8-18	
	2-1/2							
	3	546576	SG-UNF3/4-16-B		3	532708	FK-3/4-16	
4								

Compact cylinders AEU/AEUZ - Inch Series

Accessories



FESTO



Ordering data – One-way flow control valves				
	Connection		Part No.	Type
	Thread	For tubing OD		
For exhaust air				
	10-32 UNF	5/32	165008	GRLA-10-32-UNF-QS-5/32-U
		1/4	192753	GRLA-10-32-UNF-QS-1/4-U
	1/8" NPT	5/32	165009	GRLA-1/8-NPT-QS-5/32-U
		3/16	190941	GRLA-1/8-NPT-QS-3/16-U
		1/4	165010	GRLA-1/8-NPT-QS-1/4-U
	1/4" NPT	5/16	165013	GRLA-1/8-NPT-QS-5/16-U
		3/16	190944	GRLA-1/4-NPT-QS-3/16-U
		1/4	165011	GRLA-1/4-NPT-QS-1/4-U
		5/16	165014	GRLA-1/4-NPT-QS-5/16-U
			3/8	190947
For supply air				
	10-32-UNF	-	151576	GRLZ-10-UNF-B
			151579	GRLZ-10-UNF-RS-B
		3/16	151577	GRLZ-10-UNF-3/16-B
		1/4	151578	GRLZ-10-UNF-1/4-B
	1/8" NPT	-	151561	GRLZ-1/8-NPT-B
			151564	GRLZ-1/8-NPT-RS-B
		1/4	151562	GRLZ-1/8-NPT-1/4-B
		3/8	151563	GRLZ-1/8-NPT-3/8-B





Compact cylinders AEVU/AEVUZ - Inch Series

Accessories

FESTO

Ordering data – Proximity sensors for slot type 8, magneto-resistive										
	Assembly	Switch output	Electrical connection			Cable length [ft]	Part No.	Type		
			Cable	Plug M8	Plug M12					
NO contact										
	Insertable from above	PNP	3-wire	–	–	8.2	525898	SMT-8F-PS-24V-K2.5-OE		
		NPN		–	–		525909	SMT-8F-NS-24V-K2.5-OE		
		–	2-wire	–	–	8.2	525908	SMT-8F-ZS-24V-K2.5-OE		
		PNP		–	3-pin		–	1.0	525899	SMT-8F-PS-24V-K0.3-M8D
		NPN		–	–		–		525910	SMT-8F-NS-24V-K0.3-M8D
PNP	–	–	3-pin	–	1.0	525900	SMT-8F-PS-24V-K0.3-M12			
	Insertable from end, flush with the cylinder profile	PNP	3-wire	–	–	8.2	175436	SMT-8-PS-K-LED-24-B		
		–		–	3-pin		–	1.0	175484	SMT-8-PS-S-LED-24-B
NC contact										
	Insertable from above	PNP	3-wire	–	–	24.6	525911	SMT-8F-PO-24V-K7.5-OE		

Ordering data – Proximity sensors for slot type 8, magnetic reed							
	Assembly	Electrical connection		Cable length [ft]	Part No.	Type	
		Cable	Plug M8				
NO contact							
	Insertable from above	3-wire		–	8.2	525895	SME-8F-DS-24V-K2.5-OE
		–		–		16.4	525897
		2-wire		–	8.2	525907	SME-8F-ZS-24V-K2.5-OE
		–		3-pin	–	1.0	525896
	Insertable from end, flush with the cylinder profile	3-wire		–	8.2	150855	SME-8-K-LED-24
		–		3-pin	–	1.0	150857
NC contact							
	Insertable from above	3-wire		–	24.6	525906	SME-8F-DO-24V-K7.5-OE

Ordering data – Plug sockets							
	Assembly	Switch output		Connection	Cable length [ft]	Part No.	Type
		PNP	NPN				
Straight socket							
	M8 locknut	■	■	3-pin	8.2	159420	SIM-M8-3GD-2.5-PU
					16.4	159421	SIM-M8-3GD-5-PU
	M12 locknut	■	■	3-pin	8.2	159428	SIM-M12-3GD-2.5-PU
					16.4	159429	SIM-M12-3GD-5-PU
Angled socket							
	M8 locknut	■	■	3-pin	8.2	159422	SIM-M8-3WD-2.5-PU
					16.4	159423	SIM-M8-3WD-5-PU
	M12 locknut	■	■	3-pin	8.2	159430	SIM-M12-3WD-2.5-PU
					16.4	159431	SIM-M12-3WD-5-PU

Ordering data – Slot cover for slot type 8				
	Assembly	Length [ft]	Part No.	Type
	Insertable from above	2x 1.6	151680	ABP-5-S