

Ball valves VAPB, mechanically actuated





- Connecting thread to DIN 2999
- Mounting flange to ISO 5211
- Length to DIN 3202-M3
- Blow-out proof shaft assembled from inside
- Centering attachment for simple automation
- O-ring seal for use with a vacuum

Ball valves VAPB, VZBA, mechanically actuated

Product range overview

Flow, non-return and regulating valves
Ball valves and shut-off valves

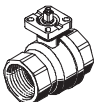
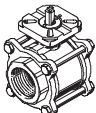
5.2

Function	Version	Type	Connection ¹⁾	Internal dia. [mm]	Flanged connection to ISO 5211	Max. operating pressure [bar]	→ Page
Ball valve 2-way	Brass						
		VAPB	Rp1/4	15	F03	40	2 / 5.2-36
			Rp3/8	15	F03	40	
			Rp1/2	15	F03	40	
			Rp3/4	20	F03	40	
			Rp1	25	F0304	40	
			Rp1 1/4	32	F0405	40	
			Rp1 1/2	40	F0405	25	
			Rp2	50	F05	25	
	Rp2 1/2	63	F07	25			
	Stainless steel, corrosion-resistant						
		VAPB-...-CR	Rp1/4	15	F0304	63	2 / 5.2-39
			Rp3/8	15	F0304		
			Rp1/2	15	F0304		
			Rp3/4	20	F0304		
			Rp1	25	F0405		
			Rp1 1/4	32	F0405		
			Rp1 1/2	40	F0507		
			Rp2	50	F0507		
Rp2 1/2			63	F0710			
Rp3			80	F0710			
Rp4	100	F10					
Ball valve 3-way	Stainless steel, corrosion-resistant						
		VZBA	Rp1/4	11.6	F0304	63	2 / 5.2-43
			Rp3/8	12.5	F0304		
			Rp1/2	12.5	F0304		
			Rp3/4	15	F0405		
			Rp1	20	F0405		
			Rp1 1/4	25	F0405		
			Rp1 1/2	32	F0405		
			Rp2	40	F0507		

1) Cylindrical barrel with female thread to DIN 2999

Ball valves VAPB, mechanically actuated

Type codes

VAPB – 1 1/2 – F – 63 – F0507 – CR

Type

VAPB	Ball valve for process automation
------	-----------------------------------

Connection to DIN 2999

1/4	Barrel with female thread Rp1/4
3/8	Barrel with female thread Rp3/8
1/2	Barrel with female thread Rp1/2
3/4	Barrel with female thread Rp3/4
1	Barrel with female thread Rp1
1 1/4	Barrel with female thread Rp1 1/4
1 1/2	Barrel with female thread Rp1 1/2
2	Barrel with female thread Rp2
2 1/2	Barrel with female thread Rp2 1/2
3	Barrel with female thread Rp3
4	Barrel with female thread Rp4

Connection type

F	Female thread
---	---------------

Max. operating pressure

25	25 bar
40	40 bar
63	63 bar

Flanged connection to ISO 5211

F03	1 pitch circle diameter of 36 mm
F0304	2 pitch circle diameters of 36 and 42 mm
F0405	2 pitch circle diameters of 42 and 50 mm
F05	1 pitch circle diameter of 50 mm
F0507	2 pitch circle diameters of 50 and 70 mm
F07	1 pitch circle diameter of 70 mm
F0710	2 pitch circle diameters of 70 and 102 mm
F10	1 pitch circle diameter of 102 mm

Material

	Brass
CR	Special steel casting

Ball valves VAPB, mechanically actuated

Technical data – Brass design



- Connecting thread
Rp1/4 ... Rp2 1/2

- Flow rate Kv
5.9 ... 535 m³/h

- Connecting thread to DIN 2999
- Mounting flange to ISO 5211
- Blow-out proof shaft assembled from inside
- Centring attachment for simple automation
- O-ring seal for use with a vacuum



General technical data									
Connection	Rp1/4	Rp3/8	Rp1/2	Rp3/4	Rp1	Rp1 1/4	Rp1 1/2	Rp2	Rp2 1/2
Valve function	2/2								
Design	2-way ball valve								
Sealing principle	Soft								
Actuation type	Mechanical								
Direction of flow	Reversible								
Type of mounting	In-line installation								
Assembly position	Any								
Working port 1, 2	1/4	3/8	1/2	3/4	1	1 1/4	1 1/2	2	2 1/2
Internal dia. [mm]	15	15	15	20	25	32	40	50	63
Flow rate Kv [m ³ /h]	5.9	9.4	17	41	70	121	200	292	535
Product weight [g]	500	500	400	500	800	1,300	1,900	3,100	3,100

Operating and environmental conditions									
Connection	Rp1/4	Rp3/8	Rp1/2	Rp3/4	Rp1	Rp1 1/4	Rp1 1/2	Rp2	Rp2 1/2
Operating medium	Compressed air, water, neutral gases, neutral fluids Vacuum								
Nominal pressure pN [bar]	40	40	40	40	40	40	25	25	25
Temperature of medium [°C]	-20 ... +150								
Corrosion resistance class CRC	1 ¹⁾								
Approved for use in the food industry	No								

1) Corrosion resistance class 1 according to Festo standard 940 070
Components requiring low corrosion resistance. Transport and storage protection. Parts that do not have primarily decorative surface requirements, e.g. in internal areas that are not visible or behind covers.

Materials		
Housing	Brass	
Ball	Brass	
Seals	Housing	Polytetrafluoroethylene, fibreglass reinforced
	Shaft	Viton

Torque ¹⁾ [Nm]									
Connection	Rp1/4	Rp3/8	Rp1/2	Rp3/4	Rp1	Rp1 1/4	Rp1 1/2	Rp2	Rp2 1/2
Δp = 0 bar	3.1	3.1	3.1	4.6	6.5	10.8	13.5	20	30
Δp = 10 bar	3.5	3.5	3.5	5.1	7.2	11.9	14.9	22	33
Δp = pN	5	5	5	6	8.5	15	19	29	45

1) Torque required for actuating the ball valve

Ball valves VAPB, mechanically actuated

Technical data – Brass design



Permissible operating pressure p as a function of the temperature of the medium t

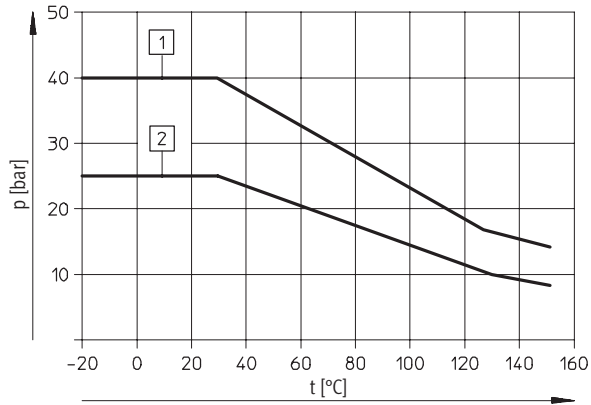

- 1 Rp1/4 ... Rp1 1/4
- 2 Rp1 1/2 ... Rp2 1/2

Dimensions

Download CAD data → www.festo.com/en/engineering

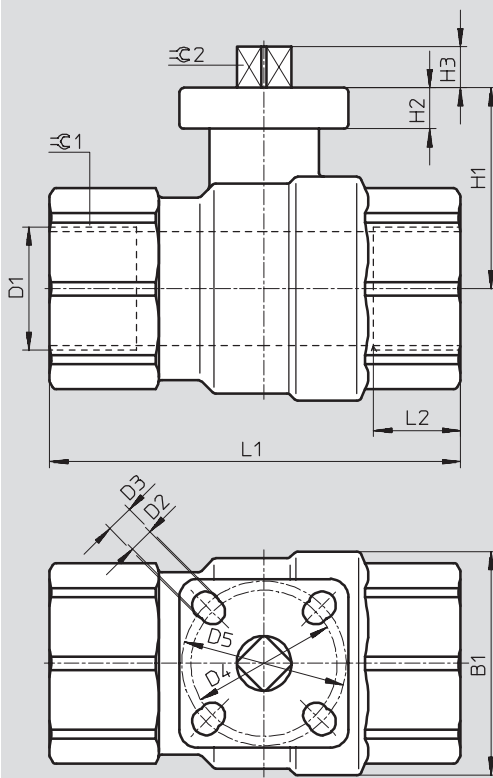

Connection D1 ¹⁾	B1	D ∅ ±0.15	D2 ∅	D3 ∅	D4 ∅	D5 ∅	H1	H2	H3	L1 ±2	L2 max.	≡C 1	≡C 2 -0.1
Rp1/4	35	15	5.5	—	36	—	40	9	9	75	15	26	9
Rp3/8	35	15	5.5	—	36	—	40	9	9	75	15	26	9
Rp1/2	35	15	5.5	—	36	—	40	9	9	75	15	26	9
Rp3/4	45	20	5.5	—	36	—	45	9	9	80	16	32	9
Rp1	55	25	5.5	5.5	36	42	45	9	9	90	19	41	9
Rp1 1/4	65	32	5.5	6.5	42	50	60	10	11	110	21	50	11
Rp1 1/2	75	40	5.5	6.5	42	50	65	10	11	120	21	55	11
Rp2	90	50	6.5	—	50	—	75	12	14	140	25	70	14
Rp2 1/2	110	63	8.5	—	70	—	85	10	15.5	143	24	83	14

1) Cylindrical barrel with female thread to DIN 2999

Ball valves VAPB, mechanically actuated

Technical data – Brass design

FESTO

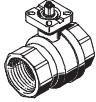
Ordering data			
Version	Connection ¹⁾	Part No.	Type
	Rp1/4	534 302	VAPB-1/4-F-40-F03
	Rp3/8	534 303	VAPB-3/8-F-40-F03
	Rp1/2	534 304	VAPB-1/2-F-40-F03
	Rp3/4	534 305	VAPB-3/4-F-40-F03
	Rp1	534 306	VAPB-1-F-40-F0304
	Rp1 1/4	534 307	VAPB-1 1/4-F-40-F0405
	Rp1 1/2	534 308	VAPB-1 1/2-F-25-F0405
	Rp2	534 309	VAPB-2-F-25-F05
	Rp2 1/2	534 310	VAPB-2 1/2-F-25-F07

1) Cylindrical barrel with female thread to DIN 2999

Ball valves VAPB, mechanically actuated

Technical data – Stainless steel design

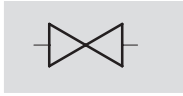

- - Connecting thread
Rp $\frac{1}{4}$... Rp4

- - Flow rate Kv
16 ... 1,414 m³/h

- Connecting thread to DIN 2999
- Mounting flange to ISO 5211
- Blow-out proof shaft assembled from inside
- Centring attachment for simple automation
- O-ring seal for use with a vacuum



General technical data												
Connection	Rp $\frac{1}{4}$	Rp $\frac{3}{8}$	Rp $\frac{1}{2}$	Rp $\frac{3}{4}$	Rp1	Rp1 $\frac{1}{4}$	Rp1 $\frac{1}{2}$	Rp2	Rp2 $\frac{1}{2}$	Rp3	Rp4	
Valve function	2/2											
Design	2-way ball valve											
Sealing principle	Soft											
Actuation type	Pneumatic											
Direction of flow	Reversible											
Type of mounting	In-line installation											
Assembly position	Any											
Internal dia. [mm]	10	12	16	20	25	32	40	50	63	80	100	
Flow rate Kv [m ³ /h]	16	21	35	46	72	105	170	275	507	905	1,414	
Product weight [g]	200	200	700	800	1,200	1,900	2,800	4,500	9,200	13,900	22,300	

Operating and environmental conditions												
Connection	Rp $\frac{1}{4}$	Rp $\frac{3}{8}$	Rp $\frac{1}{2}$	Rp $\frac{3}{4}$	Rp1	Rp1 $\frac{1}{4}$	Rp1 $\frac{1}{2}$	Rp2	Rp2 $\frac{1}{2}$	Rp3	Rp4	
Operating medium	Compressed air, water, neutral gases, neutral fluids Vacuum											
Nominal pressure [bar]	63											
Temperature of medium ¹⁾ [°C]	-10 ... +180											
Corrosion resistance class CRC	3 ²⁾											

1) As a function of operating pressure → 2 / 5.2-40

2) Corrosion resistance class 3 according to Festo standard 940 070

Components requiring higher corrosion resistance. External visible parts in direct contact with industrial atmospheres or media such as solvents and cleaning agents, with a predominantly functional requirement for the surface

Materials		
Housing	High-alloy stainless steel	
Ball	High-alloy stainless steel	
Seals	Housing	Polytetrafluoroethylene, fibreglass reinforced
	Shaft	Viton

Torque ¹⁾ [Nm]												
Connecting thread	Rp $\frac{1}{4}$	Rp $\frac{3}{8}$	Rp $\frac{1}{2}$	Rp $\frac{3}{4}$	Rp1	Rp1 $\frac{1}{4}$	Rp1 $\frac{1}{2}$	Rp2	Rp2 $\frac{1}{2}$	Rp3	Rp4	
$\Delta p = 0$ bar	5	5	7	9	13	20	28	37	49	54	62	
$\Delta p = 10$ bar	5.5	5.5	7.7	9.9	14.3	22	30.8	40.7	53.9	59.4	68.2	
$\Delta p = pN$	7	7	10	13	17	28	43	64	69	78	95	

1) Torque required for actuating the ball valve

Ball valves VAPB, mechanically actuated

Technical data – Stainless steel design



Flow, non-return and regulating valves
Ball valves and shut-off valves

5.2

Permissible operating pressure p as a function of the temperature of the medium t

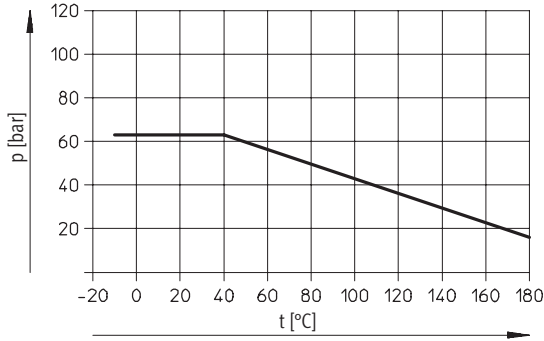

Dimensions

Download CAD data → www.festo.com/en/engineering

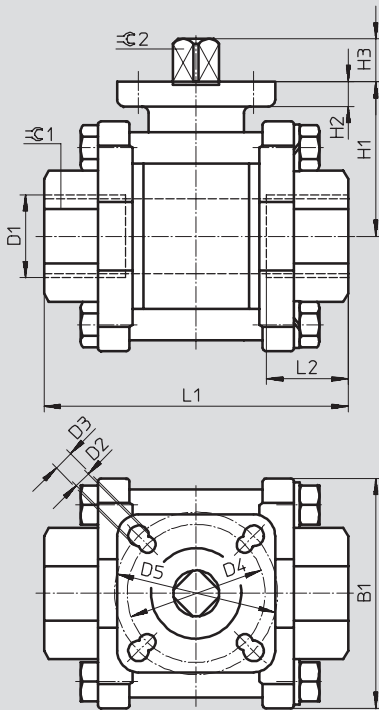

Connection D1 ¹⁾	B1	D ∅ ±0.15	D2 ∅	D3 ∅	D4 ∅	D5 ∅	H1	H2	H3	L1 ±2	L2 max.	⊖C 1	⊖C 2 -0.1
Rp1/4	50	10	5.5	5.5	36	42	40	9	7	60	14	19	9
Rp3/8	50	12	5.5	5.5	36	42	40	9	7	60	14	24	9
Rp1/2	50	16	5.5	5.5	36	42	40	9	7	75	18	29	9
Rp3/4	55	20	5.5	5.5	36	42	44	9	9	80	16	35	9
Rp1	65	25	5.5	6.5	42	50	52	10	12	90	18	41	11
Rp1 1/4	75	32	5.5	6.5	42	50	58	10	12	110	21	50	11
Rp1 1/2	85	40	6.5	9	50	70	68	13	16	120	21	58	14
Rp2	100	50	6.5	9	50	70	77	13	16	140	23	73	14
Rp2 1/2	170	65	9	11	70	102	98	13	19	185	36	90	17
Rp3	200	80	9	11	70	102	110	13	19	205	40	105	17
Rp4	250	100	11	—	102	—	138	20	24	240	40	135	22

1) Cylindrical barrel with female thread to DIN 2999

Ball valves VAPB, mechanically actuated

Technical data – Stainless steel design

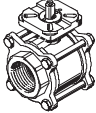

Ordering data			
Version	Connection ¹⁾	Part No.	Type
	Rp $\frac{1}{4}$	534 311	VAPB- $\frac{1}{4}$ -F-63-F0304-CR
	Rp $\frac{3}{8}$	534 312	VAPB- $\frac{3}{8}$ -F-63-F0304-CR
	Rp $\frac{1}{2}$	534 313	VAPB- $\frac{1}{2}$ -F-63-F0304-CR
	Rp $\frac{3}{4}$	534 314	VAPB- $\frac{3}{4}$ -F-63-F0304-CR
	Rp1	534 315	VAPB-1-F-63-F0405-CR
	Rp1 $\frac{1}{4}$	534 316	VAPB-1 $\frac{1}{4}$ -F-63-F0405-CR
	Rp1 $\frac{1}{2}$	534 317	VAPB-1 $\frac{1}{2}$ -F-63-F0507-CR
	Rp2	534 318	VAPB-2-F-63-F0507-CR
	Rp2 $\frac{1}{2}$	534 319	VAPB-2 $\frac{1}{2}$ -F-63-F0710-CR
	Rp3	534 320	VAPB-3-F-63-F0710-CR
	Rp4	534 321	VAPB-4-F-63-F10-CR

1) Cylindrical barrel with female thread to DIN 2999

Ball valves VZBA, mechanically actuated

Type codes



VZBA		R14	63	32	L	F0304	R
Type							
VZBA	Ball valve for process automation						
Connection to DIN 2999							
R14	Barrel with female thread Rp $\frac{1}{4}$						
R38	Barrel with female thread Rp $\frac{3}{8}$						
R12	Barrel with female thread Rp $\frac{1}{2}$						
R34	Barrel with female thread Rp $\frac{3}{4}$						
R1	Barrel with female thread Rp1						
R114	Barrel with female thread Rp1 $\frac{1}{4}$						
R112	Barrel with female thread Rp1 $\frac{1}{2}$						
R2	Barrel with female thread Rp2						
Operating pressure							
63	63 bar						
Valve function							
32	3/2-way valve						
Hole in ball							
L	L-shaped						
T	T-shaped						
Flanged connection to ISO 5211							
F0304	2 pitch circle diameters of 36 and 42 mm						
F0405	2 pitch circle diameters of 42 and 50 mm						
F0507	2 pitch circle diameters of 50 and 70 mm						
Material							
R	High-alloy stainless steel						

Ball valves VZBA, mechanically actuated

Technical data – Stainless steel design

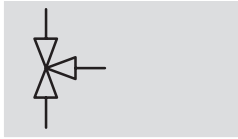

- - Connecting thread
Rp $\frac{1}{4}$... Rp2
- - Flow rate Kv
4.5 ... 1,000 m³/h

- Connecting thread to DIN 2999
- Mounting flange to ISO 5211
- Blow-out proof shaft assembled from inside
- Centring attachment for simple automation
- O-ring seal for use with a vacuum



General technical data		Rp $\frac{1}{4}$	Rp $\frac{3}{8}$	Rp $\frac{1}{2}$	Rp $\frac{3}{4}$	Rp1	Rp1 $\frac{1}{4}$	Rp1 $\frac{1}{2}$	Rp2
Connection									
Valve function		3/2							
Design		3-way ball valve							
Sealing principle		Soft							
Actuation type		Mechanical							
Direction of flow		Reversible							
Type of mounting		In-line installation							
Assembly position		Any							
Working port 1, 2, 3		$\frac{1}{4}$	$\frac{3}{8}$	$\frac{1}{2}$	$\frac{3}{4}$	1	1 $\frac{1}{4}$	1 $\frac{1}{2}$	2
Internal dia.	[mm]	11.6	12.5	12.5	15	20	25	32	40
Flow rate Kv	Type L ¹⁾ [m ³ /h]	4.5	4.5	4.7	5.1	11.8	19.6	33.2	53.7
	Type T ²⁾ [m ³ /h]	8	8	8.3	8.3	22.4	36.5	62	100
	Type T ³⁾ [m ³ /h]	4.5	4.5	4.9	4.8	10.9	18	30	48.8
Product weight	[g]	700	700	700	1,000	1,600	2,800	3,800	7,400

- 1) Ball with L-shaped hole
- 2) Ball with T-shaped hole, straight flow
- 3) Ball with T-shaped hole, flow around corner

Operating and environmental conditions		Rp $\frac{1}{4}$	Rp $\frac{3}{8}$	Rp $\frac{1}{2}$	Rp $\frac{3}{4}$	Rp1	Rp1 $\frac{1}{4}$	Rp1 $\frac{1}{2}$	Rp2
Connection									
Operating medium		Compressed air, water, neutral gases, neutral fluids Vacuum							
Nominal pressure	[bar]	63							
Temperature of medium ¹⁾	[°C]	-10 ... +140							
Corrosion resistance class CRC		3 ²⁾							

- 1) As a function of operating pressure → 2 / 5.2-44
- 2) Corrosion resistance class 3 according to Festo standard 940 070
Components requiring higher corrosion resistance. External visible parts in direct contact with industrial atmospheres or media such as solvents and cleaning agents, with a predominantly functional requirement for the surface.

Materials	
Housing	High-alloy stainless steel
Ball	High-alloy stainless steel
Seals	Polytetrafluoroethylene, fibreglass reinforced

Torque ¹⁾ at 63 bar		Rp $\frac{1}{4}$	Rp $\frac{3}{8}$	Rp $\frac{1}{2}$	Rp $\frac{3}{4}$	Rp1	Rp1 $\frac{1}{4}$	Rp1 $\frac{1}{2}$	Rp2
Connection									
$\Delta p = 1$ bar	[Nm]	8	8	8	11	18	26	32	37

- 1) Torque required for actuating the ball valve

Ball valves VZBA, mechanically actuated

Technical data – Stainless steel design



Flow, non-return and regulating valves
Ball valves and shut-off valves

5.2

Permissible operating pressure p as a function of the temperature of the medium t

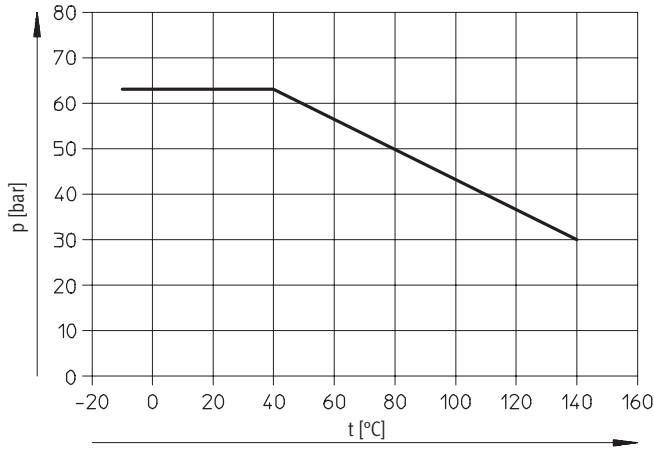

Dimensions

Download CAD data → www.festo.com/en/engineering

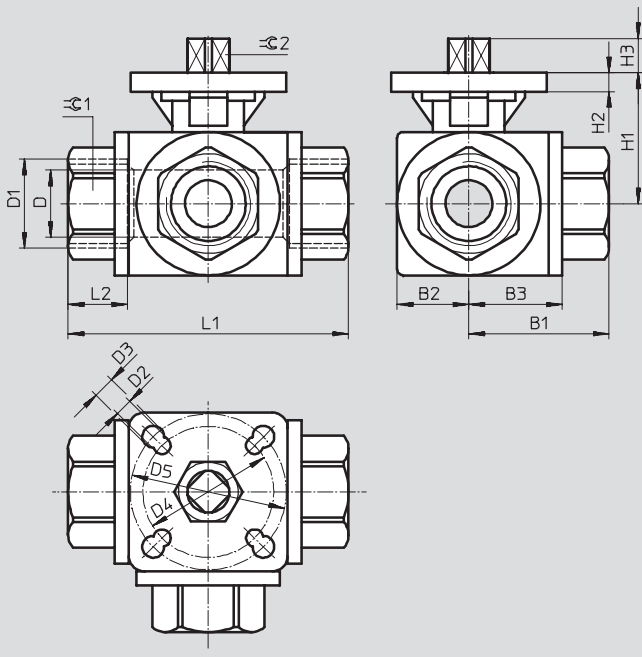

Connection D1 ¹⁾	B1	B2	B3	D ∅	D2 ∅	D3 ∅	D4 ∅	D5 ∅	H1	H2	H3	L1	L2	⊖C 1	⊖C 2
	±2			±0.15								±2			-0.1
Rp1/4	40	22.4	30	11.6	5.5	5.5	36	42	36	6	7.4	80	16	24	9
Rp3/8	40	22.4	30	12.5	5.5	5.5	36	42	36	6	7.4	80	16	24	9
Rp1/2	40	22	31	12.5	5.5	5.5	36	42	36	6	8.4	80	17.4	27	9
Rp3/4	44	23	34.7	15	5.5	6.5	42	50	42	6.2	12	88	20	34	11
Rp1	51	32	40	20	5.5	6.5	42	50	47	6.3	12	100	20.5	41	11
Rp1 1/4	62	36	47.2	25	5.5	6.5	42	50	53	6.7	11	123	24	50	11
Rp1 1/2	71	43	53	32	5.5	6.5	42	50	59	7	10.8	142	26.6	58	11
Rp2	86	55	63.5	40	6.5	8.5	50	70	66	6.2	15.8	171	27.6	70	14

1) Cylindrical barrel with female thread to DIN 2999

Ball valves VZBA, mechanically actuated

Technical data – Stainless steel design



Ordering data					
Version	Connection ¹⁾	L-shaped ball valve		T-shaped ball valve	
		Part No.	Type	Part No.	Type
	Rp $\frac{1}{4}$	542 005	VZBA-R14-63-32L-F-F0304-R	542 006	VZBA-R14-63-32T-F-F0304-R
	Rp $\frac{3}{8}$	542 007	VZBA-R38-63-32L-F-F0304-R	542 008	VZBA-R38-63-32T-F-F0304-R
	Rp $\frac{1}{2}$	542 009	VZBA-R12-63-32L-F-F0304-R	542 010	VZBA-R12-63-32T-F-F0304-R
	Rp $\frac{3}{4}$	542 011	VZBA-R34-63-32L-F-F0405-R	542 012	VZBA-R34-63-32T-F-F0405-R
	Rp1	542 013	VZBA-R1-63-32L-F-F0405-R	542 014	VZBA-R1-63-32T-F-F0405-R
	Rp1 $\frac{1}{4}$	542 015	VZBA-R114-63-32L-F-F0405-R	542 016	VZBA-R114-63-32T-F-F0405-R
	Rp1 $\frac{1}{2}$	542 017	VZBA-R112-63-32L-F-F0405-R	542 018	VZBA-R112-63-32T-F-F0405-R
	Rp2	542 019	VZBA-R2-63-32L-F-F0507-R	542 020	VZBA-R2-63-32T-F-F0507-R

1) Cylindrical barrel with female thread to DIN 2999

Hand lever for ball valves

Accessory



Hand lever

Note on materials:

- High-alloy stainless steel
- Free of copper and PTFE
- Contains paint wetting impairment substances



Dimensions

Download CAD data → www.festo.com/en/engineering

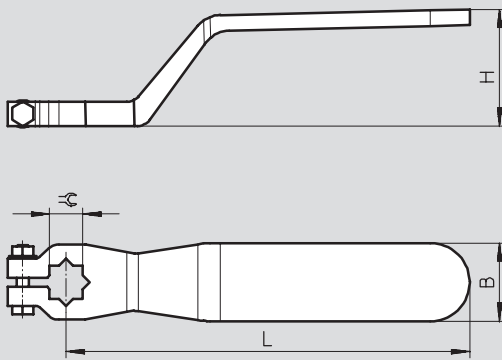

Flow, non-return and regulating valves
Ball valves and shut-off valves

5.2

Type	±0.5	L ±10	H ±5	W ±5
VAOH-9-H9	9	120	36	21
VAOH-11-H9	11	140	40	26
VAOH-14-H9	14	180	46	31
VAOH-17-H9	17	240	55	36
VAOH-22-H9	22	280	70	36

Ordering data			
Version	Weight [g]	Part No.	Type
	100	542 702	VAOH-9-H9
	200	542 703	VAOH-11-H9
	300	542 704	VAOH-14-H9
	450	542 705	VAOH-17-H9
	750	542 706	VAOH-22-H9