



- Modular valve terminal for up to 44 valves
- Straightforward valve replacement
- Lightweight construction thanks to high plastic content
- Metal valve bodies
- Wide range of electrical connection options
- Compatible with electrical peripherals CPX

Valve terminal type 12 CPA, Compact Performance

Key features



Valve terminals for standard applications
Compact Performance

2.1

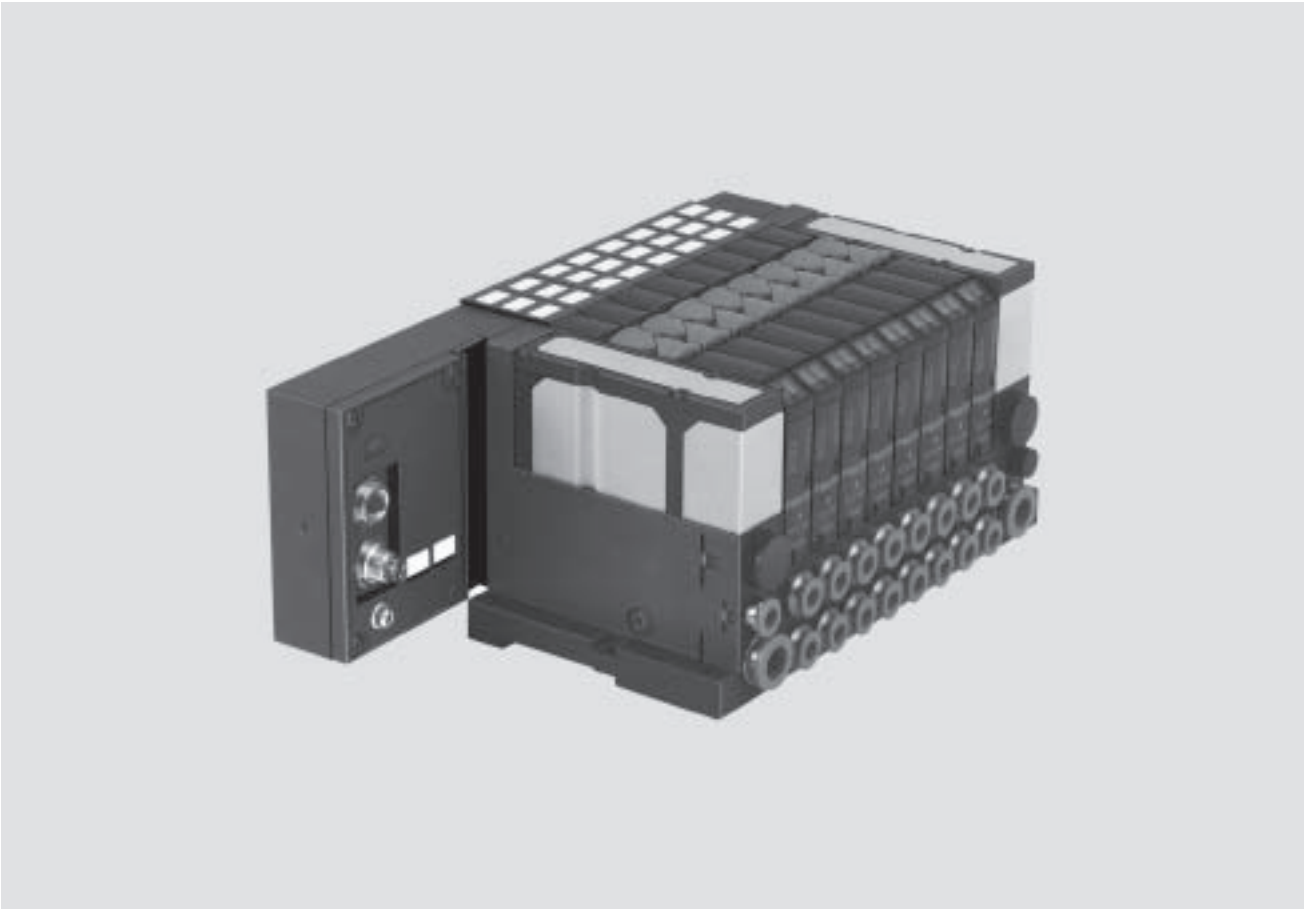

Innovative

- Compact valves in sturdy metal housing
- Patented electrical linking system for flexible expansion options
- Standardised system of electrical connection options:
 - Individual connection
 - Multi-pin connection
 - AS-interface (40 or 4140/8180)
 - Festo CP bus
 - All common fieldbuses
- Suitable for electrical peripherals CPX. This means:
 - Diagnosis down to the individual valve
 - Parameterisable error characteristics
 - Separate load voltage supply for valves
 - On the spot diagnosis using LEDs or CPX handheld device (MMI)

Flexible

- Modular system offering a range of configuration options
- Expandable up to 44 solenoid coils
- Individual conversions and extensions possible at any time
- Easy switching of valves and valve functions
- High pressure range –0.9 ... 10 bar
- Wide range of valve functions
- Multiple pressure zones

Reliable

- Sturdy metal valve bodies
- Manual override either push-in, detenting or covered
- Fast troubleshooting thanks to LEDs on the valves and diagnosis via fieldbus
- Low power consumption thanks to integrated holding current reduction, 100% duty cycle
- Reliability of service through replaceable valves
- Flexible labelling system thanks to inscription labels

Easy to assemble

- Ready to install unit, already assembled and tested
- Compact dimensions
- Low weight thanks to high plastic content, therefore:
 - Suitable for decentralised machine structures, e.g.
 - in handling technology
 - in conveyor technology
 - in the packaging industry
 - in sorting systems
 - in upstream machine functions
- Lower costs for selection, ordering, assembly and commissioning
- Wall mounting or H-rail mounting

Valve terminal type 12 CPA, Compact Performance



Key features

Equipment options

The CPA valve terminal is available with the following valve functions:

- 2x 3/2-way, single solenoid, normally open
- 2x 3/2-way, single solenoid, normally closed
- 2x 3/2-way, single solenoid, 1x normally open, 1x normally closed
- 5/2-way, single solenoid
- 5/2-way, double solenoid
- 5/3-way, mid-position pressurised
- 5/3-way, mid-position exhausted
- 5/3-way, mid-position closed

Different pressure zones can be created by using valve bases with pressure-zone separation. Space for future expansion can be reserved via a blanking plate. A valve can then be mounted in place of the blanking plate at a later time.

All valves are equipped with manual override. All utilised valves are pneumatically piloted.

The CPA valve terminal is prepared for operation with internal or external pilot air, depending on the end plate mounted on the right.

If supply pressure for the CPA valve terminal is within a range of 3 ... 8 bar, it can be operated with internally distributed pilot air. Auxiliary pilot air is branched at the right-hand end plate for this purpose. If supply pressure is not within a range of 3 ... 8 bar, the valve has to be operated with external pilot air.

Vacuum/low-pressure operation:

The CPA valve terminal can be operated with vacuum or low pressure of -0.9 ... 3 bar under the following conditions:

- Regulated auxiliary pilot air is supplied separately
- The CPA valve terminals have been equipped with the following valves:
 - 5/2-way valve, single solenoid
 - 5/2-way valve, double solenoid
 - 5/3-way valves

Valve sub-bases with 3/2-way valves are not suitable for operation with vacuum or low pressure.

Valve terminal configurator Online via → www.festo.com/en/engineering

A valve terminal configurator is available to help you select a suitable valve terminal CPA. This makes it much easier for you to find the right product.

Valve terminals are equipped and assembled according to customer requirements. This results in minimal installation time. They are also fully inspected before shipment.



Note

<p>Ordering</p> <p>A valve terminal type 12 is ordered via an order code. For valve terminals with fieldbus and CPX connection, the order code consists of a pneumatic and an electrical part.</p> <ul style="list-style-type: none"> ■ 12P-... (pneumatic components) ■ 50E-... (CPX terminal) 	<p>The pneumatic part suffices for valve terminals with individual connection, multi-pin connection, AS-interface® and CP bus.</p> <ul style="list-style-type: none"> ■ 12P-... (pneumatic components) <p>Further components are ordered via other ordering systems or order codes:</p> <ul style="list-style-type: none"> ■ ECP-... (CP installation system) ■ AS-interface components 	<p>Ordering systems</p> <p>For information about the ordering system for type 12 see → 4 / 2.1-110</p> <p>CP installation system → 4 / 4.6-2</p> <p>AS-interface connection → 4 / 4.9-2</p> <p>CPX terminal → 4 / 4.8-1</p>	<p>Product description</p> <p>The pneumatic part as well as individual and multi-pin connections are described in detail in this chapter, while the electrical functions are described in the chapter</p> <p>CPX terminal → 4 / 4.8-1</p> <p>AS-interface → 4 / 4.9-2</p> <p>CP installation system → 4 / 4.6-2</p>
--	--	--	--

Valve terminal type 12 CPA, Compact Performance

Peripherals overview

Overview – CPA type 12

Electrical components

The valve terminals are available with five different electrical connection types:

- Individual connection
- Multi-pin connection
- AS-Interface® connection (40 or 4140/8180)
- Fieldbus connection
- CPX terminal connection

The electrical connector modules are attached to the left-hand side.

Connections are established between the electrical connector modules and the valves by means of horizontal linkage and bridges.

The electrical bridge incorporates:

- LED for switching status display
- Manual override
- Coil management with current reduction
- Label holder for inscription labels

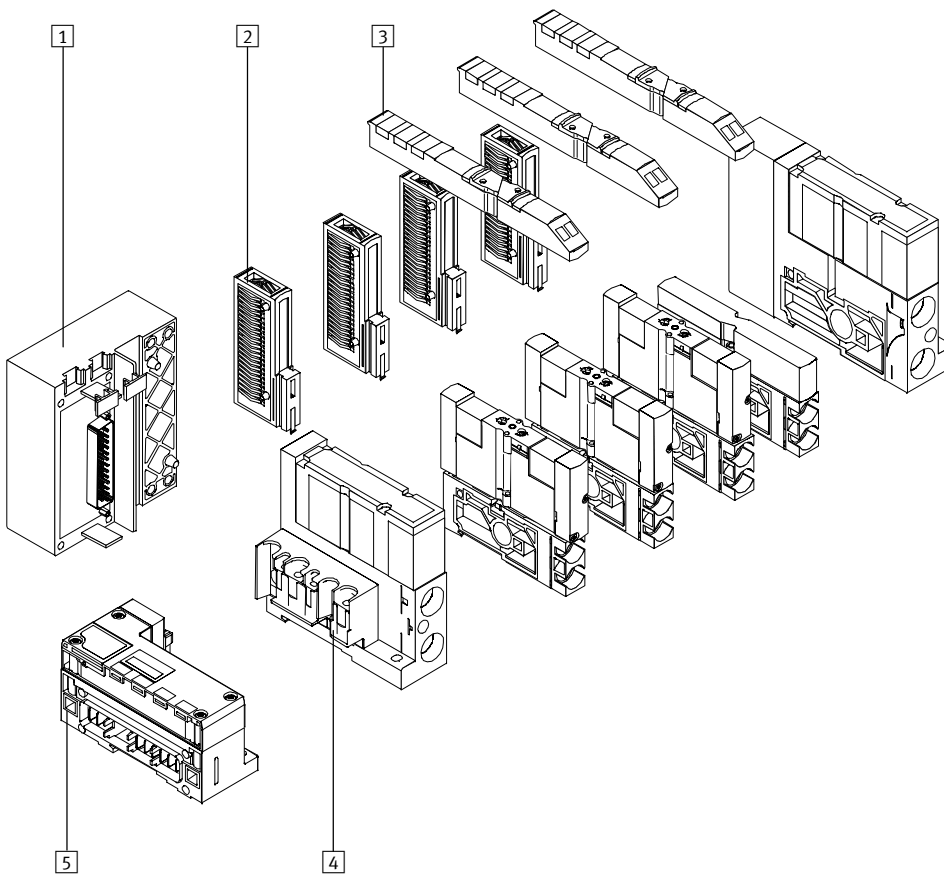

1 CPA valve terminal for CP system: MP, CP or AS-interface® connection block

2 Electrical interlinking block
3 Current bridge with manual override

4 CPX adapter for mounting of the CPX pneumatic interface

5 CPA valve terminals for CPX terminal: CPX pneumatic interface or compact module for AS-interface with 4 or 8 inputs

Valve terminal type 12 CPA, Compact Performance

Peripherals overview

FESTO

Valve terminals for standard applications
Compact Performance

2.1

Overview – CPA type 12

Pneumatic components

Modular design consisting of individual sub-bases and valves

- Pneumatic supply ports in the left-hand and right-hand end plate
- Pneumatic working lines in the sub-base

CPA valves are mounted on sub-bases. The valves are supplied and exhausted pneumatically via the sub-base.

- Size 10 mm and 14 mm
- Valves pneumatically piloted
- Piston spool with patented sealing principle

Sub-bases supply the valves with compressed air and auxiliary pilot air and facilitate exhausting.

Types of sub-base:

- Standard
- With the P duct isolated

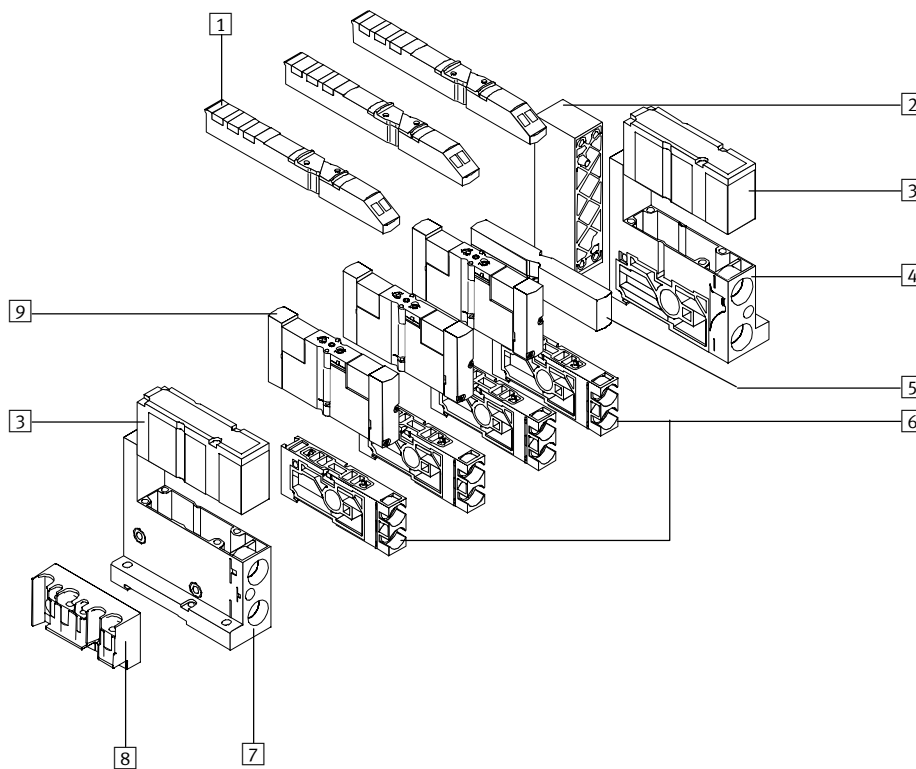

- | | | |
|---|--|--|
| <p>1 Current bridge with manual override and LEDs</p> <p>2 Terminating block</p> <p>3 End plate cover or large surface mounted silencer</p> <p>4 Right-hand end plate with supply and exhaust ports</p> | <p>5 Additional compressed air supply plate or blanking plate</p> <p>6 Sub-base:
– with working lines
– with/without pressure zone separation
– in combination with supply plate for compressed air supply</p> | <p>7 Left-hand end plate with supply and exhaust ports</p> <p>8 CPX adapter for mounting of the CPX pneumatic interface</p> <p>9 Valve module with single solenoid or double solenoid valves</p> |
|---|--|--|

Valve terminal type 12 CPA, Compact Performance

Peripherals overview

Valve terminals for standard applications
Compact Performance

2.1

Individual connection with plug sockets



Valve terminal with individual connection:
Connection is independent of the control technology used. This ensures correct polarity during installation. The connector plug is equipped with an LED which indicates switching status, and an overvoltage protective circuit.

2 to 44 solenoid coils can be selected with individual connection.

Multi-pin connection



Valve terminal with multi-pin connection:
Control signals from the controller to the valve terminal are transmitted via a pre-assembled multi-core cable, which substantially reduces installation time.

These valve terminals can be fitted with 2 to 22 solenoid coils.

AS-interface connection



Valve terminal with AS-interface connection:
A special feature of AS-interface is its ability to simultaneously transmit data and supply power via a two-core cable. The encoded cable profile prevents connection with incorrect polarity. If the valves have to be disconnected from mains power in an emergency, they can be supplied with electrical power via a separate connection.

CPA without inputs:
A CPA valve terminal with an AS-interface connection can accept 4 single solenoid valves (5/2-way function, 2x 3/2-way function, 2 valves per position) or 2 double solenoid valves, or 2 mid-position valves.

CPA with inputs:
The following can be mounted on a CPA valve terminal with inputs:
■ 4 inputs and 4 valves,
■ 8 inputs and 8 valves depending on your order.
The connection technology used for the inputs can be selected as with CPX: M8, M12, Harax, Sub-D, Cage Clamp (terminals to IP20).

Further information
➔ 4 / 4.9-2

CP installation system

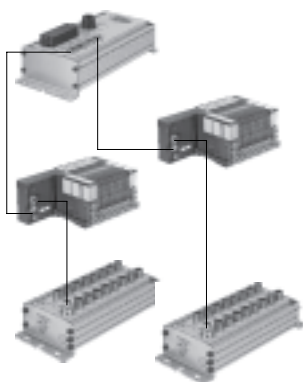

Valve terminal for CP installation system:
Valve terminals with fieldbus connection are intended for connection to fieldbus nodes or control blocks. A fieldbus node or control block allows the connection of decentralised input/output units.

4 strings, each with 16 inputs and 16 outputs, can be connected (2 to 16 solenoid coils per terminal). The connector cables transmit the power supply as well as control signals.

Further information
➔ 4 / 4.6-2

Valve terminal type 12 CPA, Compact Performance

Peripherals overview

FESTO

CPV Direct

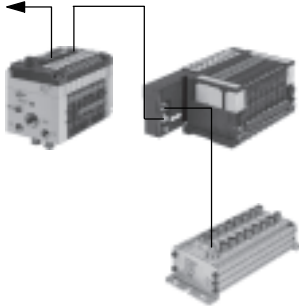

CPV Direct is a system for the compact connection of a CPV valve terminal on the basis of nine different fieldbus standards. The most important fieldbus types including Profibus, Interbus, DeviceNet and CANopen are supported.

The fieldbus node is integrated directly in the electrical interface of the CPV valve terminal and therefore takes up only a minimal amount of space.

The CP string extension option allows the functions and components of the CP installation system to be used. Instead of an output module with 8 digital outputs, a CPA valve terminal with a maximum of 8 solenoid coils can be used.

The two different CP concepts can thus be used as complementary valve terminal types.

Further information
➔ 4 / 4.7-2

CPX terminal



The electrical terminal CPX is a modular peripheral system for valve terminals. The system is specifically designed so that the valve terminal can be adapted to suit different applications.

- Variable connection options for the valve terminal pneumatic components
- Communication options with the fieldbus interface

- Flexible electrical connection technology for sensors and actuators
- Economical from the smallest configuration level right up to the maximum number of modules

The CPX terminal can also be used without valves as a remote I/O module.

Further information
➔ 4 / 4.8-2

Valve terminal type 12 CPA, Compact Performance

Key features – Pneumatic components



Valve terminals for standard applications
Compact Performance

2.1

Code	Circuit symbol	Size		Description
		10	14	
M Y	<p>Single solenoid valve, 5/2-way</p>	■	■	<p>Valve slice Y is a single solenoid valve on a double solenoid sub-base.</p> <p>■ Pneumatic spring return</p>
J	<p>Double solenoid valve, 5/2-way</p>	■	■	
B	<p>5/3-way, mid-position pressurised</p>	■	■	<p>The piston rod of a connected cylinder advances when the valve is in the normal position due to the differential piston areas.</p> <p>■ Spring force return</p>
G	<p>5/3-way, mid-position closed</p>	■	■	<p>The piston rod side of a cylinder remains held under pressure in the normal valve position.</p> <p>■ Spring force return</p>
E	<p>5/3-way, mid-position exhausted</p>	■	■	<p>In the normal valve position, the piston rod can be moved freely.</p> <p>■ Spring force return</p>
N	<p>2x 3/2-way, normally open</p>	■	■	<p>■ Pneumatic spring return</p>

Valve terminal type 12 CPA, Compact Performance



Key features – Pneumatic components

Code	Circuit symbol	Size		Description
		10	14	
K	<p>2x 3/2-way, normally closed</p>	■	■	<p>■ Pneumatic spring return</p>
H	<p>2x 3/2-way, 1x normally open (piloting 12), 1x normally closed (piloting 14)</p>	■	■	<p>For optimised cylinder movement. Corresponds to valve function M with simultaneous actuation of both solenoid coils (5/2-way, single solenoid). Since the piston area on each side can be pressurised or exhausted separately, the cylinder can move faster.</p> <p>■ Pneumatic spring return</p>

Valve terminals for standard applications
Compact Performance

2.1

Valve terminal type 12 CPA, Compact Performance

Key features – Pneumatic components



Compressed air supply and venting

The valve terminals are supplied with air via the left-hand and right-hand end plate. CPA valves used are pneumatically piloted and the auxiliary pilot air is branched from the main supply (internal) or fed via a separate connection (i.e. external).

Internal auxiliary pilot air

This can be selected when the supply pressure of the main supply (at port 1) is 3 ... 8 bar. With internal auxiliary

pilot air, the branch line is located in the right-hand end plate. There is no port 12/14.

External auxiliary pilot air

External auxiliary pilot air is required when the supply pressure of the main air (at port 1) is ≤ 3 bar or ≥ 8 bar.

In this case, pressure of 3 ... 8 bar is applied at port 12/14.

Slow pressure rise

If a gradual pressure rise by means of a soft-start valve is required for the equipment, external auxiliary pilot air should be selected, which is also fully available during the switch-on operation (see also Instructions for use → 4 / 2.1-102).

In addition to air supply, the type of exhaust is also determined by the end plates. Exhaust air is generally

discharged into the atmosphere via large surface mounted silencers.

If required, exhaust air can be drawn off via tubing lines. In this case, the end plates are fitted with covers.

End plate	
Right-hand end plate	Description
<p>For internal pilot air operation</p>	<p>Port 12/14 in right-hand end plate is not identified and sealed with a blanking plug. The auxiliary pilot air is branched internally from port 1. Pressure zone separation is permitted. Unused ports must be sealed.</p>
<p>For external pilot air operation</p>	<p>Port 12/14 in right-hand end plate for connecting the auxiliary pilot air is identified. Pressure zone separation is permitted. Unused ports must be sealed.</p>

Air supply and exhaust options	
Code	Air supply
U	Internal auxiliary pilot air supply, ducted exhaust air
V	External auxiliary pilot air supply, ducted exhaust air
W	Internal auxiliary pilot air, integrated silencer
X	External auxiliary pilot air, integrated silencer

- - Note

CPA valve terminals are not designed for mixed operation with internal or external pilot air. The sub-base for pressure zone separation does not separate the auxiliary pilot air duct.

Valve terminal type 12 CPA, Compact Performance

Key features – Pneumatic components

Creating pressure zones

CPA valve terminal with two pressure zones:

These CPA valve terminals have a sub-base with pressure zone separation. The left pressure zone is supplied with compressed air via port 1 on the left-hand end plate, while the right pressure zone is supplied with compressed air via port 1 on the right-hand end plate.

CPA valve terminal with more than two pressure zones:

A sub-base with pressure zone separation is required for each pressure zone. The external pressure zones are supplied with compressed air via port 1 on the end plates, while the other pressure zones are supplied with compressed air via port 2 of the sub-bases, which are

equipped with additional compressed air supply plates (see fig.). To remove the exhaust air, a silencer can be installed in port 4 of these sub-bases. If port 4 is not used, it must be sealed with a blanking plug.

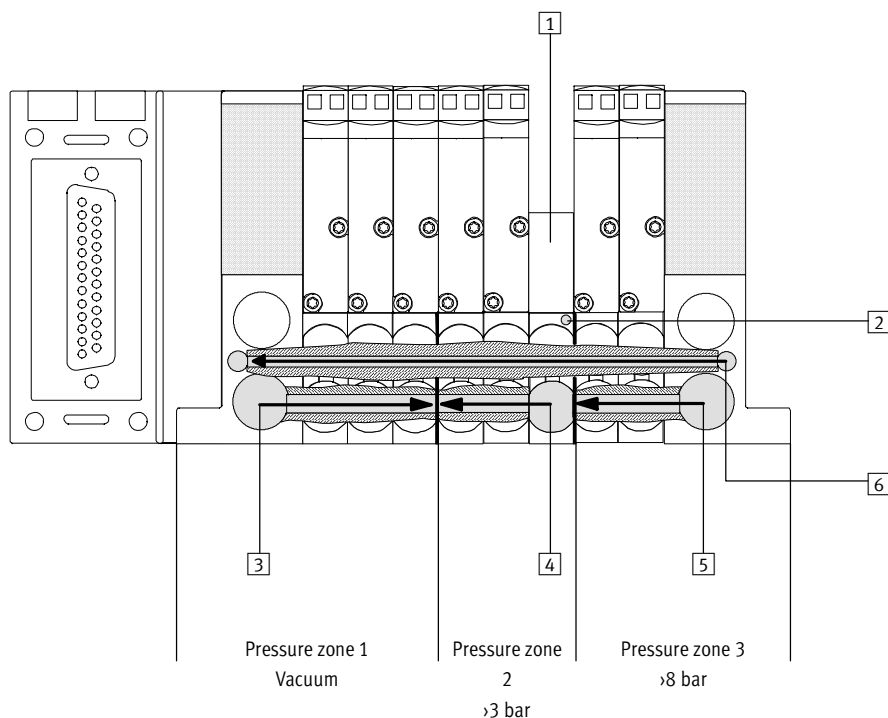

- 1 Additional compressed air supply plate
- 2 Identification of sub-bases with pressure zone separation (grey areas)
- 3 Pressure zone 1 (compressed air supply via port 1 of the left-hand end plate)
- 4 Pressure zone 2 (compressed air supply via port 2 of the sub-base with additional compressed air supply plate)
- 5 Pressure zone 3 (compressed air supply via port 1 of the right-hand end plate)
- 6 Supply for external pilot air

Number of pressure zones

The CPA valve terminal can be equipped with the following number of pressure zones depending on the connection options:

Electrical connection option	IC, MP or CPX	CP connection	AS-interface up to 4I/O	up to 8I/O
Pressure zones	1 ... 12	1 ... 9	1 ... 3	1 ... 5

Valve terminal type 12 CPA, Compact Performance

Key features – Pneumatic components



Valve terminals for standard applications
Compact Performance

Pneumatic connection

The connection technology of the CPA valve terminal is flexible and offers a wide range of connection options. Screw inserts (clip-type fittings) allow integrated push-in fittings for different tubing diameters to be used.

The following connections for the sub-bases can be selected by means of code letters. The selected code letter is valid for the entire valve terminal. The end plates are fitted with the corresponding connectors. If “QS push-in connectors” are selected for the working lines, the end plates are also fitted with QS push-in connectors.

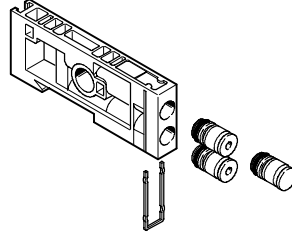

Push-in connectors for working lines							
		CPA10			CPA14		
			Code/Part No.	Description		Code/Part No.	Description
2/4	Working line	QS6	A	large	QS8	A	large
		QS4	B	small	QS6	B	small
		–	E	without cartridge	–	E	without cartridge
		QS ³ / ₁₆ ”	F	large, imperial	QS ⁵ / ₁₆ ”	F	large, imperial
		QS ⁵ / ₃₂ ”	G	small, imperial	QS ¹ / ₄ ”	G	small, imperial
12/14	Auxiliary pilot air	QS6	–	–	QS6	–	–
82/84	Exhaust air	QS6	–	–	QS6	–	–
1	Main air	QS8	–	–	QS10	–	–
3/5	Exhaust air (ducted)						
Plug-in silencer for additional pressure supply		UC-QS-6H	165 007	–	UC-QS-8H	175 611	–

Valve terminal type 12 CPA, Compact Performance

Key features – Assembly

Assembly

Sturdy terminal assembly thanks to:

- Four through-holes for wall mounting
- Integrated attachment for H-rail mounting

Wall mounting:

- The CPA valve terminal is screwed onto the mounting surface using four M4 screws.

H-rail mounting:

- For H-rail mounting of the CPA valve terminal, you will need the mounting kit CPA-BG-NRH.

Wall mounting

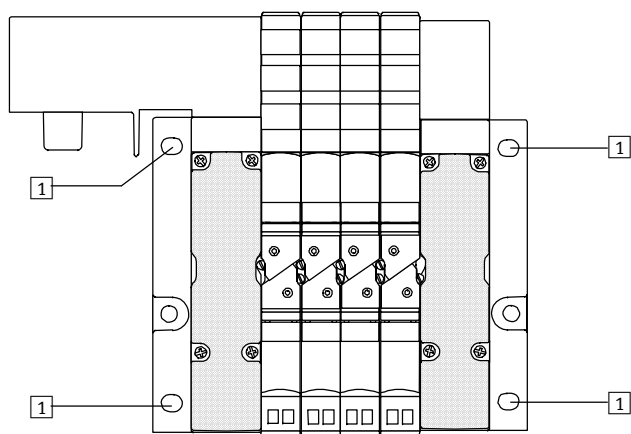

1 4 holes for wall mounting

H-rail mounting

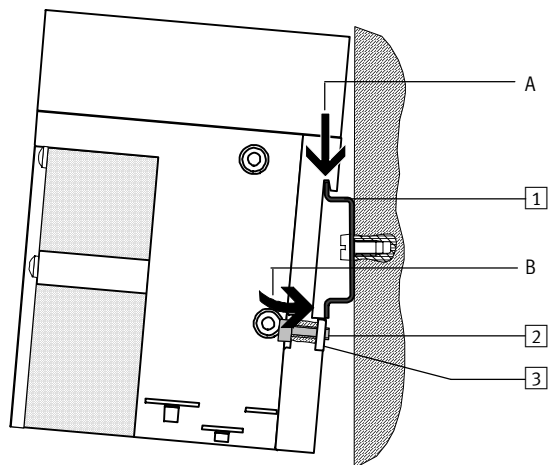

The CPA valve terminal is attached to the H-rail (see arrow A). The terminal is then rotated on the H-rail and secured in place with the clamping component (see arrow B).

- 1 H-rail to EN 50 022
- 2 Self-tapping M4x10 screw of the H-rail clamping unit

- 3 Clamping component of the H-rail clamping unit

Valve terminal type 12 CPA, Compact Performance

Key features – Display and operation

Display and operation

The CPA valve terminal contains the following pneumatic connection and control elements:

LED

- LEDs for displaying the switching status
- Readable from the “top” as well as from the “front”
- Indicator “12” shows the switching status of the pilot control for output 2
- Indicator “14” shows the switching status of the pilot control for output 4

Manual override

- Push-in
- Detenting
- Covered (not with individual connection)
- Retrofit/conversion from push-in to detenting

Inscription labels

- Clip with inscription field on cable socket (with individual connection)
- Inscription clips on connection node (MP, CP, AS-interface or CPX terminal)
- Inscription clips on the valve sub-bases (not with individual connection)

Position of display and control elements

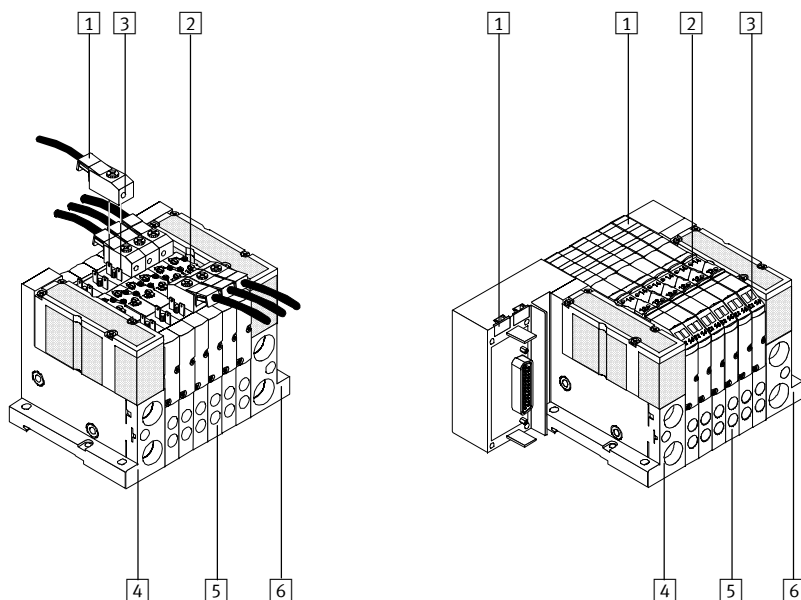

- 1 Inscription clips
- 2 Manual override
- 3 Yellow LED, signal status display of pilot solenoid coils
- 4 Supply ports (1) and exhaust port (3/5, 82/84) on left-hand end plate
- 5 Working lines (2, 4), per valve sub-base
- 6 Supply ports (1, 12/14) and exhaust port (3/5) on right-hand end plate

Valve terminal type 12 CPA, Compact Performance



Key features – Display and operation

Manual override (MO)

The manual override MO is used during commissioning to check that the pneumatic equipment is operating. In the design with individual connection IC, the manual override can be either push-in or detenting.

In the electrical manifold module variant, the manual override is either push-in or detenting via a slide. Accidental activation of the slide can be avoided with the aid of a clip.

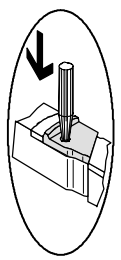
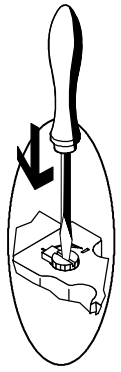
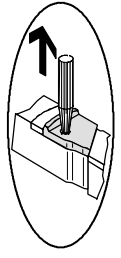
The manual override can also be covered. Accidental activation can be avoided by covering the manual override.

Manual override, push-in			
CPA valve terminal with MP, CP, AS-interface connection or CPX terminal	CPA valve terminal with IC connection	Operation	Valve response
		<p>Press in the stem of the MO until the valve switches.</p> <p>Note regarding CPA valve terminals with IC connection: Do not turn the stem once it has been pressed in, otherwise the MO will engage.</p>	<p>The valve:</p> <ul style="list-style-type: none"> ■ moves to the switching position
		Keep the stem of the MO pressed.	■ remains in the switching position
		Release the stem. The spring returns the stem of the MO to the initial position.	■ returns to the initial position (not in the case of double solenoid valve type J)



Valve terminal type 12 CPA, Compact Performance

Key features – Display and operation

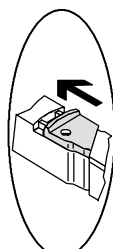
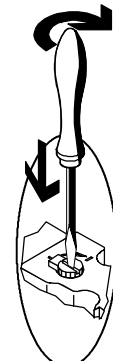
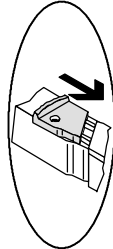

Valve terminals for standard applications
Compact Performance

2.1

Manual override, detenting			
CPA valve terminal with MP, CP, AS-interface connection or CPX terminal	CPA valve terminal with IC connection	Operation	Valve response
		<p>CPA valve terminal with MP, CP, AS-interface connection or CPX terminal: Move the slide of the MO outwards until the stop is reached.</p> <p>CPA valve terminals with IC connection: Press in the stem of the MO until the valve switches, then turn the stem clockwise until the stop is reached.</p>	<p>The valve: ■ moves to the switching position</p>
		Leave the slide or stem in position.	■ remains in the switching position
		<p>CPA valve terminal with MP, CP, AS-interface connection or CPX terminal: Move the slide of the MO inwards until the stop is reached.</p> <p>CPA valve terminals with IC connection: Turn the stem anti-clockwise until the stop is reached, then release the stem.</p>	<p>■ returns to the initial position (not in the case of double solenoid valve type)</p>

Valve terminal type 12 CPA, Compact Performance

Key features – Electrical components

Electrical connection

The CPA valve terminal can be actuated using multiple electrical connectors. If individual connecting cables are used for each solenoid coil, the socket is screwed directly onto the solenoid. For all other connection types, an electrical manifold module for the solenoid coils is used, which results in a common connection.

This common connection is available for the electrical multi-pin cable, AS-interface or CP installation system. In addition, CPA can be combined with the CPX terminal, with which there is a wide selection of fieldbus connections and electrical peripheral modules available.

An individual connection (max. 44 solenoid coils in 22 valve positions) has a built-in current reducing circuit in the plug of the connecting cable. In the case of connection types with an electrical manifold module, the current reduction function is integrated in the bridge module, which links the solenoid coils with the electrical manifold module.

Valve terminal with individual connection

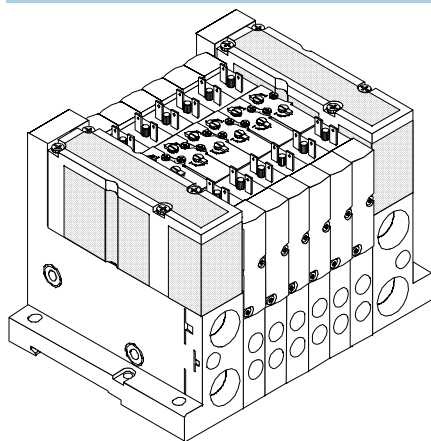

Connection socket KMYZ-7-...

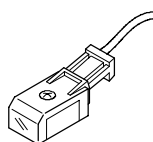

Electrical power as a result of current reduction

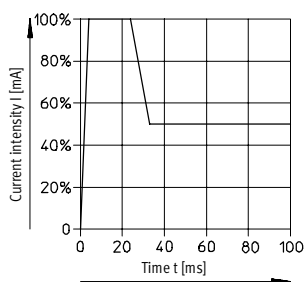

Valve terminal type 12 CPA, Compact Performance

Key features – Electrical components

FESTO

Dimensions – Plug socket with cable for individual connection

Download CAD data → www.festo.com/en/engineering

Type KMYZ-7-24-...

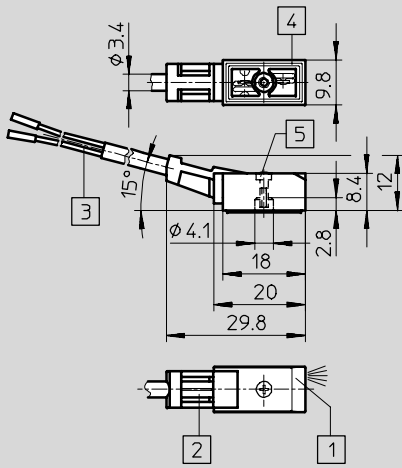

- 1 LED illuminated area
- 2 Location for inscription label
- 3 2-core cable, 2.5 m, 5 m or 10 m (2x 0.25 mm²)
- 4 Connection pattern for MZC
- 5 Type of mounting:
Self-tapping EJOT-PT screw
KB 1.8x7, captive
max. tightening torque
0.35 Nm

Ordering data

Code	Designation	Type	Part No.	
D	Plug socket with cable, with integrated current reduction, 24 V DC, LED, PUR cable suitable for chain link trunking	2.5 m	KMYZ-7-24-2,5-LED-PUR	193 683
E		5 m	KMYZ-7-24-5-LED-PUR	194 685
F		10 m	KMYZ-7-24-10-LED-PUR	196 070
Accessories to be ordered separately (not in order code)				
Inscription labels 6x10 in frames		IBS 6x10	18 576	
User documentation – CPA Pneumatics				
German		P.BE-CPA-DE	173 514	
English		P.BE-CPA-EN	173 515	
Spanish		P.BE-CPA-ES	173 516	
French		P.BE-CPA-FR	173 517	
Italian		P.BE-CPA-IT	173 518	
Swedish		P.BE-CPA-SV	173 519	

Valve terminal type 12 CPA, Compact Performance

Key features – Electrical components

Multi-pin connection

In addition to pneumatic integration, multi-pin connection results in integration of the electrical side as well, and facilitates connection to the control cabinet and the valve terminal via a single cable. Sub-D 25-pin plugs are used for connection.

For simple connection, pre-assembled cables with IP65 protection can be supplied.

Standard lengths of 5 m and 10 m are available.

Possible number of valves:

- max. 22 valves
- max. 22 solenoid coils

Multi-pin connection

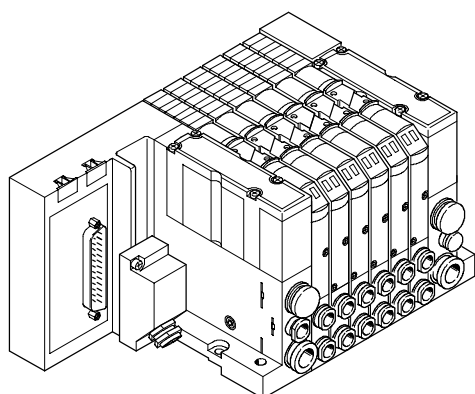

25-pin Sub-D multi-pin socket

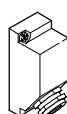

Ordering data			
Code	Designation	Type	Part No.
Y	Plug socket Sub-D, 25-pin, IP65	SD-SUB-D-BU25	18 709
R	Connecting cable Sub-D, 25-pin	5 m	KEA-1-25P-5
S		10 m	KEA-1-25P-10
H	Attachment for H-rail mounting	CPA-BG-NRH	173 567
B	Express waiver - no user documentation to be included (already available)		
Accessories to be ordered separately (not in order code)			
	Inscription labels 6x10 in frames	IBS 6x10	18 576
	Connecting cable, for chain link trunking, with 25-pin Sub-D plug	5 m, PVC	KMP4-25P-5-PVC
		5 m, PUR	KMP4-25P-5-PUR
		10 m, PVC	KMP4-25P-10-PVC
		10 m, PUR	KMP4-25P-10-PUR
User documentation – CPA Pneumatics			
	German	P.BE-CPA-DE	173 514
	English	P.BE-CPA-EN	173 515
	Spanish	P.BE-CPA-ES	173 516
	French	P.BE-CPA-FR	173 517
	Italian	P.BE-CPA-IT	173 518
	Swedish	P.BE-CPA-SV	173 519

Valve terminal type 12 CPA, Compact Performance

Key features – Electrical components



Connecting cable for multi-pin

Type KEA-1-25P-...
KMP4-...

Cable with 25-pin Sub-D plug for valve terminal with multi-pin connection (24-core, 0.25 mm²)

The electrical manifold module is available for single solenoid (1 contact: 14) and double solenoid (2 contacts: 14/12) valves, whereby a single solenoid valve can occupy a double solenoid valve position (but not the other way around). In this case an output signal is lost, which must be taken into account during programming.

The same applies to a spare position or compressed air supply.

The number of valves that can be activated may be reduced as a result.

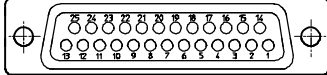
Pin allocation			
Plug view	Pin	Core colour	Valve 24 V DC
 	1	White	Coil 0
	2	Green	Coil 1
	3	Yellow	Coil 2
	4	Grey	Coil 3
	5	Pink	Coil 4
	6	Blue	Coil 5
	7	Red	Coil 6
	8	Purple	Coil 7
	9	Grey-pink	Coil 8
	10	Red-blue	Coil 9
	11	White-green	Coil 10
	12	Brown-green	Coil 11
	13	White-yellow	Coil 12
	14	Yellow-brown	Coil 13
	15	White-grey	Coil 14
	16	Grey-brown	Coil 15
	17	White-pink	Coil 16
	18	Pink-brown	Coil 17
	19	White-blue	Coil 18
	20	Brown-blue	Coil 19
	21	White-red	Coil 20
	22	Brown-red	Coil 21
	23	White-black	0 V DC ¹⁾
	24	Brown	0 V DC ¹⁾
	25	Black	0 V DC ¹⁾

1) 0 V for positive switching control signals; connect 24 V for negative switching control signals; mixed operation is not permitted.

 Note

The drawing shows the view onto the Sub-D socket at the multi-pin cable KEA-1-25P-....

Valve terminal type 12 CPA, Compact Performance

Key features – Electrical components

AS-interface® connection

The AS-interface permits the spatial distribution of individual components or small component groups. Each bus segment can be extended up

to 100 m, or up to 300 m using repeaters. The valve terminal type 12 CPA can be used at the AS-interface in different configuration levels.

The valve terminal current bridge contains the LEDs which indicate the operating status and the protective circuit for the valves.

➔ AS-interface
4 / 4.9-23

CPA without inputs

The AS-interface connection of valve terminal type 12 can be used to control up to four solenoid coils.

This results in small valve terminals with two, three or four valves.

AS-interface valve terminal Standard

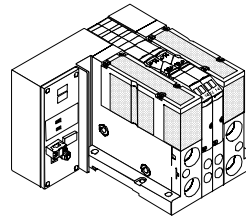

AS-interface valve terminal with additional power supply

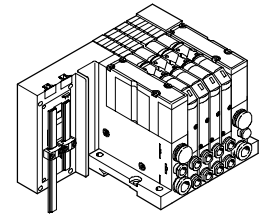

CPA with inputs

Using the AS-interface connection of valve terminal type 12, up to

- 4 inputs and 4 outputs
- 8 inputs and 8 outputs

can be controlled.

The connection technology used for the inputs can be selected as with CPX: M8, M12, Harax, Sub-D, Cage Clamp (terminals to IP20).
➔ CPX 4 / 2.1-101

Selectable connection technology

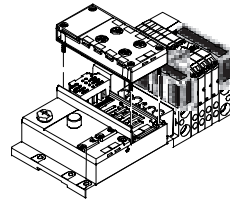

M8 connection technology

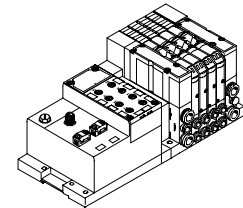

M12 connection technology

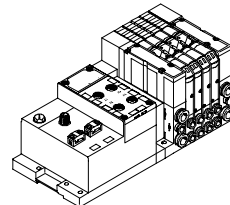

Cage Clamp connection technology

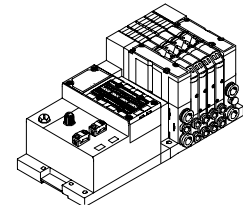

Valve terminal type 12 CPA, Compact Performance

Key features – Electrical components



CP system connection

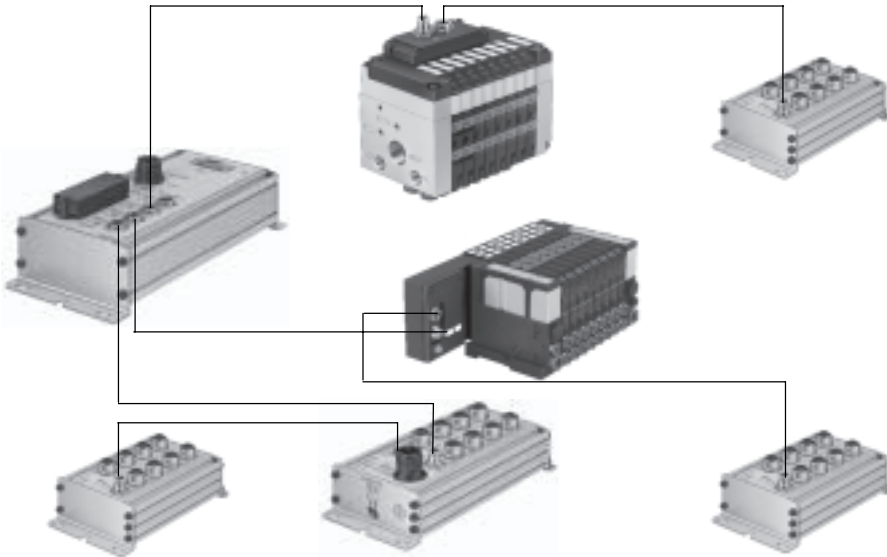

The CP installation system is capable of meeting two completely different requirements and resolves the conflict between extensive decentralised modularisation and electrical installation.

High-speed machines require short pneumatic tubing and valves that are mounted close to the cylinders. The CP installation system was developed to meet these requirements without having to wire each valve individually.

The system integrates the manifold integrated valve terminals CPV, the sub-base valve terminal CPA and various input/output modules in a single installation concept.

All CP valve terminals and CP modules are connected using a ready to install CP cable, and are attached to the CP fieldbus node. One CP valve terminal and one CP input module make up an installation string that ends at the CP fieldbus node. The installation system supports a maximum of 4 installation strings, which can be connected to the fieldbus node.

Each string can be extended up to a maximum length of 10 metres.

The CP fieldbus node is the central connection point for the fieldbus and for the valve actuation and sensor power supply. It is here that the relevant bus parameters are set by means of switches and the standard fieldbus connector is attached. The power supply for the sensors connected to the input modules is separate from the load voltage of the valves.

→ CP installation system
4 / 4.6-2

Valve terminal type 12 CPA, Compact Performance

Key features – Electrical components

Connection to the modular electrical peripherals CPX



CPX electrical peripherals with selectable connection technology

- IP65 and IP20 protection in various electrical connection options
- Mounting directly on the machine or installation in the control cabinet
- Up to 10 electrical modules plus pneumatics

- Electrical modules with
 - 8 digital inputs
 - 4 digital inputs
 - 4 digital outputs
 - 8 digital inputs/outputs
 - 2 analogue inputs
 - 2 analogue outputs
- Diagnostic functions; module or channel oriented

- Central diagnosis using a fieldbus and local diagnosis using a handheld device; the information is shown in plain text or via the LED display on the module
- Profibus DP
- Interbus
- DeviceNet
- CANopen
- CC-Link

Selectable connection technology and more for CPX

A flexible solution

- Selectable connection technology
- Parameterisable switching characteristics

■ Parameterisable diagnosis

- Flexible power supply

■ Interchangeable connection technology

- Interchangeable electronics modules

■ Separate power supply for:

- Electronics and inputs
- Electrical outputs
- CPA valves

M8

Compact for pre-assembled individual connection



M12-5POL

Pre-assembled and sturdy with 2 signals per socket



M12-8POL

Connection to DNCV



Clamps (CageClamp®)

Fast connection technology for use in control cabinets



Sub-D

Multi-pin connection for I/O distributor or console



Harax

Sturdy, fast connection technology for individual connections



→ CPX terminal
4 / 4.8-2

Valve terminal type 12 CPA, Compact Performance

Instructions for use



Pneumatic equipment

Operate your equipment with unlubricated compressed air if possible. Festo valves and cylinders are designed for operation under normal use without any additional lubrication, yet still have a long service life. The quality of compressed air downstream from the compressor must correspond to that of unlubricated compressed air. If possible, do not operate all of your equipment with lubricated compressed air. The lubricators should, where possible, always be installed directly upstream of the actuator used.

Incorrect additional oil and too high an oil content in the compressed air reduce the service life of the valve terminal.

Use Festo special oil OFSW-32 or the alternatives listed in the Festo catalogue (as specified in DIN 51 524-HLP32; basic oil viscosity 32 CST at 40 °C).

Bio-oils

When using bio-oils (oils which are based upon synthetic or native ester, e.g. rapeseed oil methyl ester), the maximum residual oil content of 0.1 mg/m³ must not be exceeded (see ISO 8573-1 Class 2).

Mineral oils

When using mineral oils (e.g. HLP oils to DIN 51 524, parts 1 through 3) or similar oils based on poly-alpha-olefins (PAO), the maximum residual oil content of 5 mg/m³ must not be exceeded (see ISO 8573-1 Class 4).

A higher residual oil content irrespective of the compressor oil cannot be permitted, as the basic lubricant would be washed away over time.

External pilot air

If supply pressure for your CPA valve terminal is not in the range 3 ... 8 bar, you must operate it with external pilot air. The auxiliary pilot air is supplied via port 12/14 in this case.



Note

If your CPA valve terminal is equipped with valve sub-bases (3/2-way valves), the external pilot

air must be set according to the supply pressure with which these valves are operated (see graphs).

Switch-on pilot pressure

CPA10

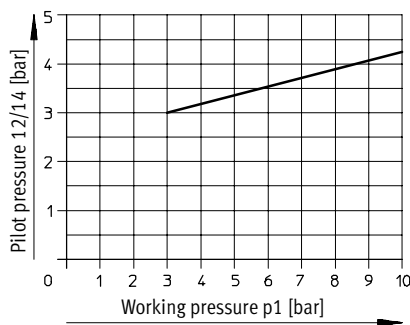

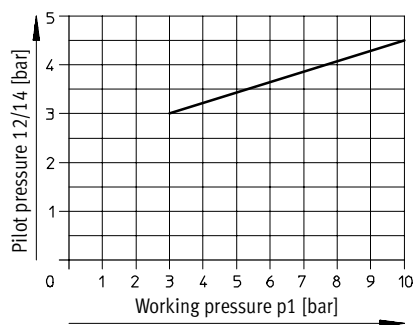

CPA14



Valve terminal type 12 CPA, Compact Performance

Technical data – CPA10

-  - Flow rates of up to
CPA10: 300 l/min
CPA14: 600 l/min

-  - Valve width
CPA10: 10 mm
CPA14: 14 mm

-  - Voltage
24 V DC

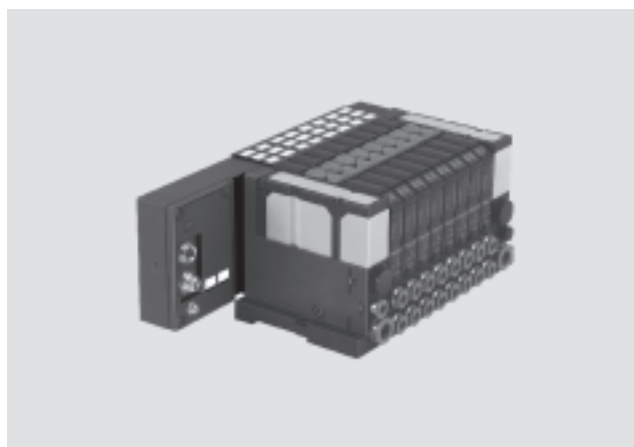

General technical data – CPA10								
Valve function	5/2-way valve		2x3/2-way valve			5/3-way valve		
	single solenoid	double solenoid	normally open	normally closed	1x normally open, 1x normally closed	mid-position pressurised	mid-position exhausted	mid-position closed
Code	M, Y	J	N	K	H	B	E	G
Constructional design	Electromagnetically pilot actuated piston spool valve							
Width	10 mm							
Nominal size	3.6 mm							
Lubrication	Lubrication for life, PWIS-free							
Type of mounting	Via foot mounting On H-rail in accordance with DIN EN 50 022							
Mounting position	Any							
Manual override	Push-in or detenting							
Pneumatic connection								
Pneumatic connection	Via end plates							
Pneumatic connection 1	6 and 8 mm							
Pilot air port 12/14	4 and 6 mm							
Pneumatic connection 2/4	4 and 6 mm							
Main exhaust air port 3/5	6 and 8 mm							
Pilot exhaust air port 82/84	4 and 6 mm							
Nominal flow rate (without fittings) [l/min]	280	280	220	220	220	220 130 ¹⁾	200 130 ¹⁾	330

1) Mid-position

Operating pressure [bar]								
Code	M, Y	J	N	K	H	B	E	G
Without pilot air supply	3 ... 8 bar							
With pilot air supply $P_1/P_{12} = P_{14}$	-0.9 ... +10 bar		3 ... 10 bar			-0.9 ... +10 bar		
Pilot pressure $P_{12} = P_{14}$	3 ... 8 see graph → 4 / 2.1-102							

Valve terminal type 12 CPA, Compact Performance

FESTO

Technical data – CPA10

Valve terminals for standard applications
Compact Performance

Valve response times [ms]									
Code		M, Y	J	N	K	H	B	E	G
Response times	on	11	–	8	8	8	13	13	13
	off	18	–	18	18	18	17	20	17
	reverse	–	7	–	–	–	–	–	–

Ambient conditions	
Operating medium	Filtered compressed air, lubricated or unlubricated, inert gases → 4 / 2.1-102
Grade of filtration [µm]	40 average pore size
Ambient temperature [°C]	–5 ... +50
Temperature of medium [°C]	–5 ... +50
Corrosion resistance class CRC ¹⁾	2

1) CRC2: Corrosion resistance class 2 to Festo standard 940 070
Components with medium corrosion exposure. Externally visible components with significant decorative function in direct contact with normal industrial atmosphere or media such as coolants and lubricants.

2.1

Electrical data	
Electromagnetic compatibility of CP valve terminal with CP connection	Interference emission tested to EN 61 000-6-4, industry Interference immunity ¹⁾ tested to EN 61 000-6-2, industry
Protection against electric shock (protection against direct and indirect contact to EN 60204-1/IEC 204)	By means of PELV power supply unit
CE certification	In accordance with EU Directive 89/336/EU (not IC connection)
Operating voltage DC	24 V (+10/–15%)
Edge steepness (IC and MP only)	> 0.4 V/ms minimal voltage rise time to reach the high-current phase
Residual ripple	4 V _{ss}
Electrical power consumption	0.4 W (high-current phase approx. 30 ms)
Duty cycle	100%
Protection class to EN 60 529	IP65 (for all types of signal transmission in assembled state)
Relative air humidity	90% non-condensing
Vibration resistance	To DIN/IEC 68/EN 60 068, Parts 2-6 <ul style="list-style-type: none"> ■ Up to 5 valve blocks (without additional mounting): 0.35 mm at 10 ... 60 Hz, 5 g at 60 ... 150 Hz ■ Up to 6 valve blocks (with additional mounting): 0.35 mm at 10 ... 60 Hz, 5 g at 60 ... 150 Hz ■ 6 valve blocks or more (without additional mounting): 0.15 mm at 10 ... 58 Hz, 2 g at 58 ... 150 Hz
Shock resistance	To DIN/IEC 68/EN 60 068, Parts 2-27 <ul style="list-style-type: none"> ■ Up to 5 valve blocks (without additional mounting): +/-30 g at 11 ms, 15 cycles ■ Up to 6 valve blocks (with additional mounting): +/-30 g at 11 ms, 15 cycles ■ 6 valve blocks or more (without additional mounting): +/-15 g at 11 ms, 15 cycles
Continuous shock resistance	To DIN/IEC 68/EN 60 068, Parts 2-29: +/-15 g at 6 ms, 1000 cycles

1) The maximum signal line length is 10 m

Materials	
Electrical part (MP, AS-interface, FB)	PAXMD-GF-50
Valve slices	Die-cast aluminium, polyphenylene sulphide (PPS), ST, AL
Integrated silencer	PA6T/X-GF-40
Seal	Nitrile rubber

Weights [g]		
	MP, CP, AS-interface connection or CPX terminal	IC connection
Basic weight	280	210
Per valve position	120	100

Valve terminal type 12 CPA, Compact Performance



Technical data – CPA14

General technical data – CPA14								
Valve function	5/2-way valve		2x3/2-way valve			5/3-way valve		
	single solenoid	double solenoid	normally open	normally closed	1x normally open, 1x normally closed	mid-position pressurised	mid-position exhausted	mid-position closed
Code	M, Y	J	N	K	H	B	E	G
Constructional design	Electromagnetically pilot actuated piston spool valve							
Width	14 mm							
Nominal size	5 mm							
Lubrication	Lubrication for life, PWIS-free							
Type of mounting	Via foot mounting On H-rail in accordance with DIN EN 50 022							
Mounting position	Any							
Manual override	Push-in or detenting							
Pneumatic connection	Via end plates							
Pneumatic connection 1	8 and 10 mm							
Pilot air port 12/14	4 and 6 mm							
Pneumatic connection 2/4	6 and 8 mm							
Main exhaust air port 3/5	8 and 10 mm							
Pilot exhaust air port 82/84	4 and 6 mm							
Nominal flow rate (without fittings) [l/min]	600	600	550	550	550	550 400 ¹⁾	550 400 ¹⁾	550

1) Mid-position

Operating pressure [bar]								
Code	M, Y	J	N	K	H	B	E	G
Without pilot air supply	3 ... 8 bar							
With pilot air supply $P_1/P_{12} = P_{14}$	-0.9 ... +10 bar		3 ... 10 bar			-0.9 ... +10 bar		
Pilot pressure $P_{12} = P_{14}$	3 ... 8 see graph → 4 / 2.1-102							

Valve response times [ms]									
Code	M, Y	J	N	K	H	B	E	G	
Response times	on	17	-	9	9	9	13	13	13
	off	29	-	28	28	28	39	39	30
	reverse	-	10	-	-	-	-	-	-

Valve terminal type 12 CPA, Compact Performance

Technical data – CPA14



Ambient conditions		
Operating medium	Filtered compressed air, lubricated or unlubricated, inert gases → 4 / 2.1-102	
Grade of filtration	[µm]	40 average pore size
Ambient temperature	[°C]	-5 ... +50
Temperature of medium	[°C]	-5 ... +50
Corrosion resistance class CRC ¹⁾	2	

1) Corrosion resistance class 2 according to Festo standard 940 070
Components requiring moderate corrosion resistance. Externally visible parts with primarily decorative surface requirements which are in direct contact with a surrounding industrial atmosphere or media such as cooling or lubricating agents.

Electrical data	
Electromagnetic compatibility of CP valve terminal with CP connection	Interference emission tested to EN 61 000-6-4, industry
	Interference immunity ¹⁾ tested to EN 61 000-6-2, industry
Protection against electric shock (protection against direct and indirect contact to EN 60204-1/IEC 204)	By means of PELV power supply unit
CE certification	In accordance with EU Directive 89/336/EU (not IC connection)
Operating voltage DC	24 V (+10/-15%)
Edge steepness (IC and MP only)	> 0.4 V/ms voltage increase time to reach the high-current phase
Residual ripple	4 V _{ss}
Electrical power consumption	0.65 W (high-current phase approx. 30 ms)
Duty cycle	100%
Protection class to EN 60 529	IP65 (for all types of signal transmission in assembled state)
Relative air humidity	90% non-condensing
Vibration resistance	To DIN/IEC 68/EN 60 068, Parts 2-6 <ul style="list-style-type: none"> ■ Up to 5 valve blocks (without additional mounting): 0.35 mm at 10 ... 60 Hz, 5 g at 60 ... 150 Hz ■ Up to 6 valve blocks (with additional mounting): 0.35 mm at 10 ... 60 Hz, 5 g at 60 ... 150 Hz ■ 6 valve blocks or more (without additional mounting): 0.15 mm at 10 ... 58 Hz, 2 g at 58 ... 150 Hz
Shock resistance	To DIN/IEC 68/EN 60 068, Parts 2-27 <ul style="list-style-type: none"> ■ Up to 5 valve blocks (without additional mounting): +/-30 g at 11 ms, 15 cycles ■ Up to 6 valve blocks (with additional mounting): +/-30 g at 11 ms, 15 cycles ■ 6 valve blocks or more (without additional mounting): +/-15 g at 11 ms, 15 cycles
Continuous shock resistance	To DIN/IEC 68/EN 60 068, Parts 2-29: +/-15 g at 6 ms, 1000 cycles

1) The maximum signal line length is 10 m

Materials	
Electrical part (MP, AS-interface, FB)	PAXMD-GF-50
Valve slices	Die-cast aluminium, polyphenylene sulphide (PPS), ST, AL
Integrated silencer	PA6T/X-GF-40
Seal	Nitrile rubber

Weights [g]	MP, CP, AS-interface connection or CPX terminal		IC connection
Basic weight	460		300
Per valve position	190		150

Valve terminal type 12 CPA, Compact Performance

Technical data – CPA10/14



Dimensions

Download CAD data → www.festo.com/en/engineering

Individual connection

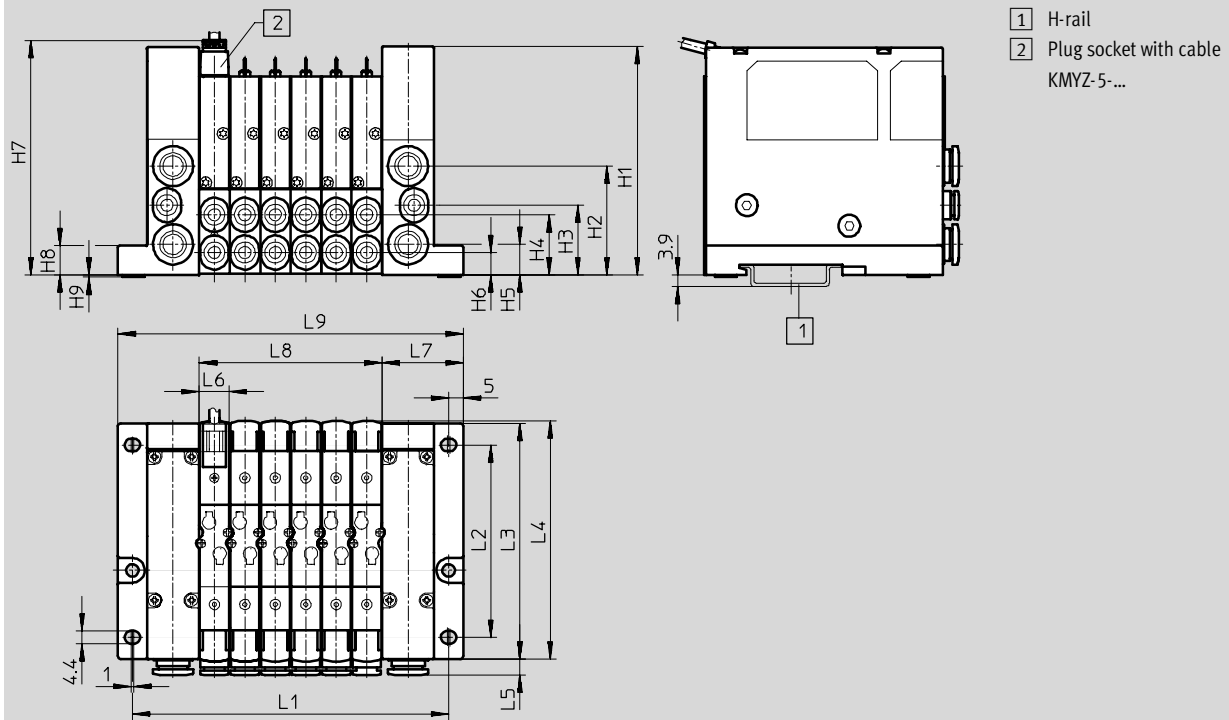

Valve terminals for standard applications
Compact Performance

2.1

Type	L1	L2	L3	L4	L5	L6	L7	L8	L9	H1	H2	H3	H4	H5	H6	H7	H8
CPA10	45+ (nx 10.6)	66.3	81.3	82.2	5.5	10.6	28	nx 10.6	56+ (nx 10.6)	78.8	37.5	24	20.7	10.5	7.7	80	10
CPA14	51+ (nx 14.6)	76.1	91.1	92.6	6.5	14.6	31	nx 14.6	62+ (nx 14.6)	91	43	27.5	26.5	12	9.5	92.5	12

n = Number of valve slices

Valve terminal type 12 CPA, Compact Performance

Technical data – CPA10/14

Dimensions

Download CAD data → www.festo.com/en/engineering

AS-interface connection with inputs

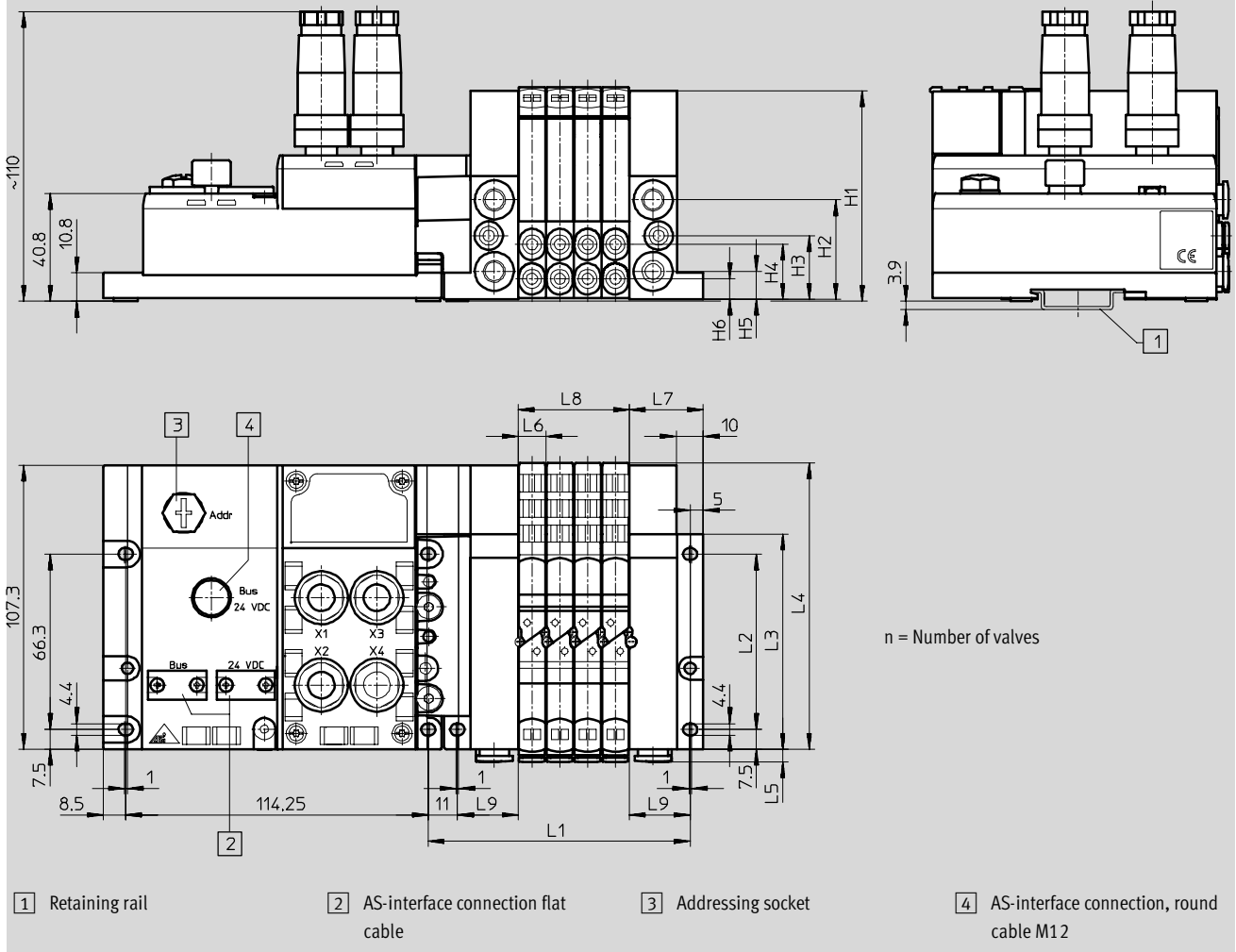

Type	L1	L2	L3	L4	L5	L6	L7	L8	L9	H1	H2	H3	H4	H5	H6
CPA 10	46 + 11 + (nx 10.6)	66.3	81.3	108.3	5.5	10.6	28	nx 10.6	23	79.5	37.5	24	20.7	10.5	7.7
CPA 14	52 + 11 + (nx 14.6)	76.1	91.1	118.1	6.5	14.6	31	nx 14.6	26	92	43	27.5	26.5	12	9.5

Valve terminals for standard applications
Compact Performance

2.1

Valve terminal type 12 CPA, Compact Performance

Technical data – CPA10/14 with CPX interface

Dimensions Download CAD data → www.festo.com/en/engineering

Connection blocks and valves

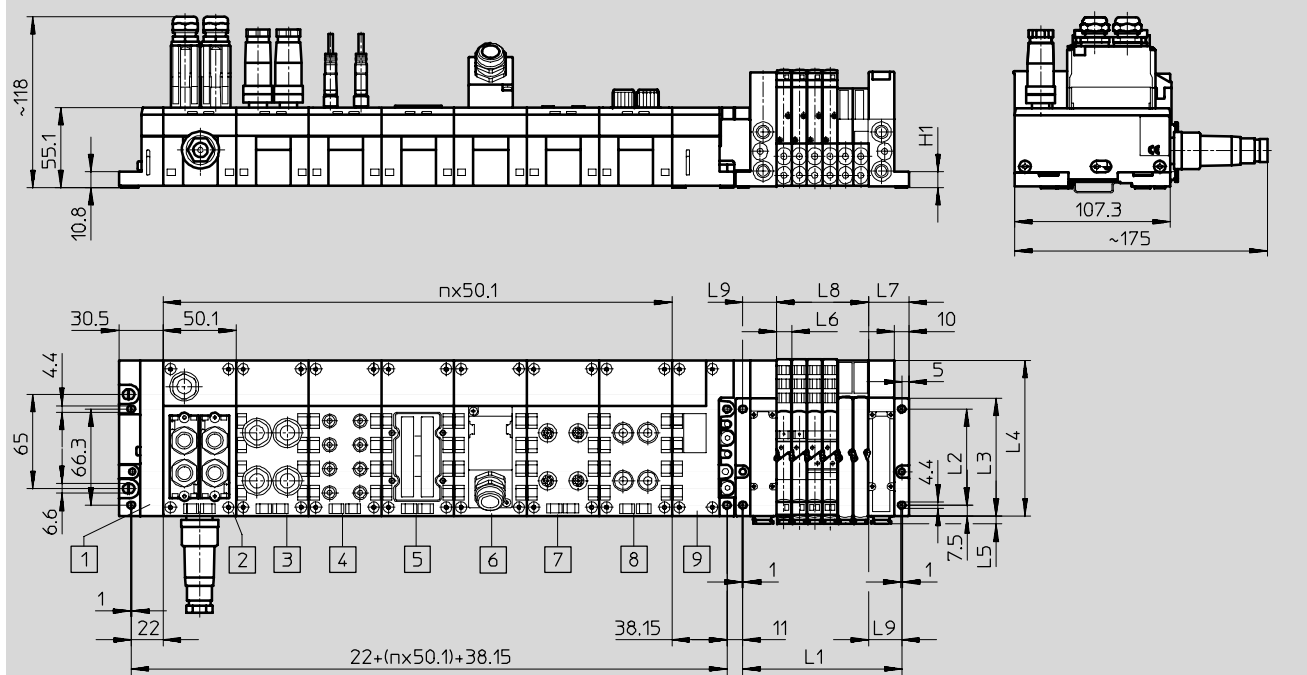

Legend:

1 End plate, left-hand	4 Connection block CPX-AB-8-M8-3POL	7 Connection block CPX-AB-4-HARx2-4POL	n = Number of bus nodes and connection blocks for CPX m = Number of valves
2 Fieldbus node	5 Connection block CPX-AB-8-KL-4POL	8 Connection block CPX-AB-4-M12x2-5POL	
3 Connection block CPX-AB-4-M12-8POL	6 Connection block CPX-AB-1-SUB-BU-25POL	9 Pneumatic interface	

Type	L1	L2 ±0.1	L3	L4	L5	L6	L7	L8	L9 ±0.1	H1
CPA10	46 + (mx 10.6)	66.3	81.3	108.3	5.5	10.6	28	mx 10.6	23	10.8
CPA14	51 + (mx 14.6)	76.1	91.1	118.1	6.5	14.6	31	mx 14.6	26	13

Valve terminals for standard applications
 Compact Performance
2.1

Valve terminal type 12 CPA, Compact Performance – With individual connection



Ordering data – Modular products

Valve terminals for standard applications
Compact Performance

2.1

M Mandatory data →

Module No.	Valve terminal, pneumatic part	Size	Electrical connection	Pneumatic connection	Manual override	End plates/pressure supply
173 520 174 001	12P	10 14	IC	A B E	R	U V W X
Ordering example						
173 520	12P	- 10	- IC	- B	R	- U
1	2	3	4	5	6	7

Ordering table

Size	10	14	Condi- tions	Code	Enter code
M 1 Module No.	173 520	174 001			
2 Valve terminal, pneumatic part	Compact Performance type 12 CPA			12P	12P
3 Size	Grid 10 mm	–		-10	
	–	Grid 14 mm		-14	
4 Electrical connection	Individual connection		1	-IC	-IC
5 Pneumatic connection	QS connections (for 2/4), large (QS6) (QS8)			-A	
	QS connections (for 2/4), small (QS4) (QS6)			-B	
	Connection (2/4) without cartridge			-E	
6 Manual override	Detenting			R	R
7 End plates/pressure supply	Internal auxiliary pilot air supply, ducted exhaust air		2	-U	
	External auxiliary pilot air supply, ducted exhaust air			-V	
	Internal auxiliary pilot air supply, integrated silencers		2	-W	
	External auxiliary pilot air supply, integrated silencers			-X	

1 **IC** Max. 22 valve positions and 22 coils.

2 **U, W** Not for vacuum; pressure range 3 ... 8 bar.

Transfer order code

	12P	-		-	IC	-	R	-	
1	2		3		4		5	6	7

Valve terminal type 12 CPA, Compact Performance – With individual connection



Ordering data – Modular products

M Mandatory data																				O Options				
Equipment at valve position 0 ... 21																				Accessories				
8 Valve functions: M, J, B, G, E, N, K, H, A, D 9 Pressure zone separation: T																				...D ...E ...F H B				
Valve position																								
0	1	2	3	4	5	6	7	8	9	10	11	12	13	14	15	16	17	18	19	20	21			
-	B	G	M	E	ET	M	D	J	T	J	M	B											+ H2E	
8 + 9																				10				

Ordering table					
Size	10	14	Condi- tions	Code	Enter code
↓	Equipment at valve position 0 ... 21		[3]	-	-
M 8	Valve functions			M	Enter equip- ment selection for valve positions in order code.
	5/2-way valve, single solenoid			J	
	5/2-way valve, double solenoid			B	
	5/3-way valve, mid-position pressurised			G	
	5/3-way valve, mid-position closed			E	
	5/3-way valve, mid-position exhausted			N	
	2x3/2-way valve, single solenoid, normally open		[4]	K	
	2x3/2-way valve, single solenoid, normally closed		[4]	H	
	2x3/2-way valve, single solenoid, 1x normally open, 1x closed		[4]	A	
	Blanking plate for vacant position (2 coils)			D	
Additional pressure supply with silencer			T		
9	Pressure zone separation Valve position 0 ... 21		[5]		
O 10	Accessories			+	+
	Connection socket for individual connection, PVC	Cable 2.5 m Cable 5 m Cable 10 m	1 ... 99		...D ...E ...F
	Attachment for H-rail mounting		1		H
	User documentation		Express waiver - no user documentation to be included (already available)		B

[3] Equipment at valve position 0 ... 21
 The valve positions must be equipped throughout without any gaps.
 Number of valve positions min. 2, max. 22;
 Number of solenoid coils: max. 22;
 Coil usage: D, T: 0 coils
 M: 1 coil
 J, B, G, E, N, K, H, A: 2 coils.

[4] N, K, H Not for vacuum;
 pressure range 3 ... 8 bar.
[5] T T can be selected as an option in addition to a valve position.
 At least one additional power supply D must be selected between 2 or more pressure zone separations.

Transfer order code

0	1	2	3	4	5	6	7	8	9	10	11	12	13	14	15	16	17	18	19	20	21			
-																							+ []	
8 + 9																				10				

Valve terminal type 12 CPA, Compact Performance – With common connection



Ordering data – Modular products

Valve terminals for standard applications
Compact Performance

2.1

Mandatory data →

Module No.	Valve terminal, pneumatic part	Size	Electrical connection	Pneumatic connection	Manual override	End plates/pressure supply	
173 520	12P	10	MP	A	N	U	
174 001		14	AS	B	R	V	
				AZ	E	V	W
				FB			X
				CX			
Ordering example							
174 001	12P	- 14	- AS	- B	V	- W	
1	2	3	4	5	6	7	

Ordering table

Size	10	14	Condi- tions	Code	Enter code
M 1 Module No.	173 520	174 001			
2 Valve terminal, pneumatic part	Compact Performance type 12 CPA			12P	12P
3 Size	Grid 10 mm	–		-10	
	–	Grid 14 mm		-14	
4 Electrical connection	Multi-pin connection		1	-MP	
	AS-interface connection, standard		2	-AS	
	AS-interface connection, additional power supply		2	-AZ	
	Fieldbus connection, CP		3	-FB	
	CPA adapter set for CPX terminal		1	-CX	
5 Pneumatic connection	QS connections (for 2/4), large (QS6) (QS8)			-A	
	QS connections (for 2/4), small (QS4) (QS6)			-B	
	Connection (2/4) without cartridge			-E	
6 Manual override	Pushing			N	
	Detenting			R	
	Covered			V	
7 End plates/pressure supply	Internal auxiliary pilot air supply, ducted exhaust air		4	-U	
	External auxiliary pilot air supply, ducted exhaust air			-V	
	Internal auxiliary pilot air supply, integrated silencers		4	-W	
	External auxiliary pilot air supply, integrated silencers			-X	

- 1** **MP, CX** Max. 22 valve positions and 22 coils.
- 2** **AS, AZ** Max. 4 valve positions and 4 coils.

- 3** **FB** Max. 16 valve positions and 16 coils.
- 4** **U, W** Not for vacuum; pressure range 3 ... 8 bar.

Transfer order code

	12P	-		-		-	
1	2		3		4		5

Valve terminal type 12 CPA, Compact Performance – With common connection



Ordering data – Modular products

M Mandatory data		O Options
Equipment at valve position 0 ... 21		Accessories
8 Valve functions: M, Y, J, B, G, E, N, K, H, A, C, D 9 Pressure zone separation: T		Y R S H B
Valve position		
0 1 2 3 4 5 6 7 8 9 10 11 12 13 14 15 16 17 18 19 20 21		
- M E C		+ YRHB
8 + 9		10

Ordering table					
Size	10	14	Condi- tions	Code	Enter code
↓	Equipment at valve position 0 ... 21		5	-	-
M 8	Valve functions			M	Enter equip- ment selection for valve positions in order code.
	5/2-way valve, single solenoid			Y	
	5/2-way valve, single solenoid, duo plate			J	
	5/2-way valve, double solenoid			B	
	5/3-way valve, mid-position pressurised			G	
	5/3-way valve, mid-position closed			E	
	5/3-way valve, mid-position exhausted			N	
	2x3/2-way valve, single solenoid, normally open		6	K	
	2x3/2-way valve, single solenoid, normally closed		6	H	
	2x3/2-way valve, single solenoid, 1x normally open, 1x closed		6	A	
	Blanking plate for vacant position (2 coils)			C	
	Blanking plate for vacant position (1 coil)			D	
	Additional pressure supply with silencer			T	
9	Pressure zone separation Valve position 0 ... 21		7		
O 10	Accessories			+	+
	Plug socket Sub-D, 25-pin IP65	1	8	Y	
	Connecting cable 25-core, 5 m	1	8	R	
	Sub-D 25-core, 10 m	1	8	S	
	Attachment for H-rail mounting	1	9	H	
	User documentation	Express waiver - no user documentation to be included (already available)		9	B

5 Equipment at valve position 0 ... 21

The valve positions must be equipped throughout without any gaps.
 Number of valve positions: min. 2, max. 22;
 Number of solenoid coils: max. 22;
 Coil usage: T: 0 coils
 M, C, D: 1 coil
 Y, J, B, G, E, N, K, H, A: 2 coils.

6 N, K, H Not for vacuum;
 pressure range 3 ... 8 bar.

7 T T can be selected as an option in addition to a valve position.
 At least one additional power supply D must be selected between 2 or more
 pressure zone separations.

8 Y, R, S Not with electrical connection FB.
9 H, B Not with electrical connection CX.

Transfer order code

0	1	2	3	4	5	6	7	8	9	10	11	12	13	14	15	16	17	18	19	20	21
-																					
8 + 9																					
+																					
10																					

Valve terminal type 12 CPA, Compact Performance – AS-interface



Ordering data – Modular products

Valve terminals for standard applications
Compact Performance

2.1

M Mandatory data →

Module No.	Valve terminal, pneumatic part	Size	Electrical connection	Pneumatic connection	Manual override	End plates/pressure supply
535 847	12P	10	CA	A B E	N R V	U V W X
535 848		14				
Ordering example						
535 847	12P	- 10	- CA	- B	- R	- U
1	2	3	4	5	6	7

Ordering table

Size	10	14	Condi- tions	Code	Enter code	
M 1	Module No.	535 847	535 848			
2	Valve terminal, pneumatic part	Compact Performance type 12 CPA – AS-Interface			12P	12P
3	Size	Grid 10 mm	-	-10		
		-	Grid 14 mm	-14		
4	Electrical connection	CPA adapter set for AS-interface with inputs			-CA	-CA
5	Pneumatic connection	QS connections (for 2/4), large (QS6) (QS8)		-A		
		QS connections (for 2/4), small (QS4) (QS6)		-B		
		Connection (2/4) without cartridge		-E		
6	Manual override	Pushing		-N		
		Detenting		-R		
		Covered		-V		
7	End plates/pressure supply	Internal auxiliary pilot air supply, ducted exhaust air		-U		
		External auxiliary pilot air supply, ducted exhaust air		-V		
		Internal auxiliary pilot air supply, integrated silencers		-W		
		External auxiliary pilot air supply, integrated silencers		-X		

Transfer order code

	12P	-		-	CA	-		-		-	
1	2		3		4		5		6		7

Valve terminal type 12 CPA, Compact Performance – AS-interface

Ordering data – Modular products



Valve terminals for standard applications
Compact Performance

2.1

M Mandatory data							
Equipment at valve position 0 ... 7							
8 Valve functions: M, Y, J, B, G, E, N, K, H, A, C, D 9 Pressure zone separation: T							
Valve position							
0	1	2	3	4	5	6	7
- M	MT	M	J				
8 + 9							

Ordering table						
Size	10	14	Condi- tions	Code	Enter code	
↓	Equipment at valve position 0 ... 7		1	-	-	
M 8	Valve functions			M	Enter equip- ment selection for valve positions in order code.	
	5/2-way valve, single solenoid			Y		
	5/2-way valve, single solenoid, duo plate			J		
	5/2-way valve, double solenoid			B		
	5/3-way valve, mid-position pressurised			G		
	5/3-way valve, mid-position closed			E		
	5/3-way valve, mid-position exhausted			N		
	2x3/2-way valve, single solenoid, normally open			K		
	2x3/2-way valve, single solenoid, normally closed			H		
	2x3/2-way valve, single solenoid, 1x normally open, 1x closed			A		
	Blanking plate for vacant position (2 coils)			C		
	Blanking plate for vacant position (1 coil)			D		
	Additional pressure supply with silencer					
9	Pressure zone separation		2	T		
	Valve position 0 ... 7					

1 Equipment at valve position 0 ... 7
 The valve positions must be equipped throughout without any gaps.
 Number of valve positions: min. 2;
 Coil usage: T: 0 coils
 M, C, D: 1 coil
 Y, J, B, G, E, N, K, H, A: 2 coils.

2 T
 T can be selected as an option in addition to a valve position.
 At least one additional power supply D must be selected between 2 or more pressure zone separations.
 Not directly possible with additional power supply D.

Transfer order code

0	1	2	3	4	5	6	7
-							
8 + 9							

Valve terminal type 12 CPA, Compact Performance – AS-interface



Ordering data – Modular products

Valve terminals for standard applications
Compact Performance

2.1

M Mandatory data →

Valve terminal, electrical part	Electrical actuator/ inputs and outputs	Connection technology for AS-interface	Connection technology for inputs	User documentation
52E	AE4 A04 AE8	VS VR	X W R J H B	D E F I S V B
Ordering example				
52E	- AE8	- VS	- X	- D
1	2	3	4	5

Ordering table			Condi- tions	Code	Enter code
M	1	Valve terminal, electrical part	Valve terminal CPA, AS-interface with inputs	52E	52E
	2	Electrical actuator/inputs and outputs	AS-interface with 4 inputs	-AE4	
			AS-interface with 4 inputs, without auxiliary power supply	-A04	
			AS-interface with 8 inputs	-AE8	
	3	Connection technology for AS-interface	Preparation for flat cable connection	-VS	
			Preparation for M12 connection	-VR	
	4	Connection technology for inputs	Connection block, 4xM12, 5-pin, double	-X	
			Connection block, 4xM12, 5-pin, double, screened	-W	
			Connection block, 8xM8, 3-pin	-R	
			Connection block, 8x CageClamp clamps, 4-pin	-J	
			Connection block, 4x Harax, 4-pin	-H	
			Connection block Sub-D, 25-pin socket	-B	
	5	User documentation	German	-D	
			English	-E	
			French	-F	
			Italian	-I	
			Spanish	-S	
			Swedish	-V	
			Express waiver - no manual to be included (already available)	-B	

Transfer order code

52E - - - - -

1 2 3 4 5

Valve terminal type 12 CPA, Compact Performance – AS-interface



Ordering data – Modular products

Options

Electrical accessories

...S, ...T, ...W, ...P, ...X, ...K, ...C, ...R, ...A, ...E, ...GS, ...GT, ...GU, ...GV, ...GR, ...GX, H

+ 4S

6

Ordering table

			Condi- tions	Code	Enter code
0	6	Electrical accessories		+	+
		Sensor plug, Pg7	1 ... 99	...S	
		straight, M12 Pg9	1 ... 99	...T	
		Sensor plug, M12 4-pin for 2.5 mm cable OD	1 ... 99	...W	
		5-pin	1 ... 99	...P	
		DUO plug, M12 for 2 cables	1 ... 99	...X	
		5-pin for 2 cables	1 ... 99	...K	
		Sensor plug, screw-in	1 ... 99	...C	
		straight, M8 solderable	1 ... 99	...R	
		Sensor plug Harax 4-pin	1 ... 99	...A	
		Plug Sub-D 25-pin	1 ... 99	...E	
		Flat cable socket	1 ... 99	...GS	
		Cable turned through 180°	1 ... 99	...GT	
		M12 socket for	1 ... 99	...GU	
		flat cable with Pg13.5	1 ... 99	...GV	
		M12 socket, Pg9, 5-pin	1 ... 99	...GR	
		straight		...GX	
		Flat cable distributor	1 ... 99	H	
		Attachment for H-rail mounting	1		

Transfer order code

+

6



Valve terminal type 12 CPA, Compact Performance



Accessories

Valve terminals for standard applications
Compact Performance

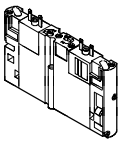
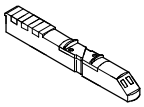

2.1

Ordering data – CPA10				
	Code	Valve function	Type	Part No.
Equipment for valve positions				
	M/Y	5/2-way valve, single solenoid/double solenoid	CPA10-M1H-5LS	173 449
	J	5/2-way valve, double solenoid	CPA10-M1H-5JS	173 450
	B	5/3-way valve, mid-position pressurised	CPA10-M1H-5/3-BS	173 453
	G	5/3-way valve, mid-position closed	CPA10-M1H-5/3-GS	173 454
	E	5/3-way valve, mid-position exhausted	CPA10-M1H-5/3-ES	173 455
	N	2x 3/2-way valve, single solenoid, normally open	CPA10-M1H-2x3-OLS	173 451
	K	2x 3/2-way valve, single solenoid, normally closed	CPA10-M1H-2x3-GLS	173 452
	H	2x 3/2-way valve, single solenoid, 1x normally open, 1x closed	CPA10-M1H-3OLS-3GLS	175 122
Current bridge with manual override				
	N	For 1 coil, manual override push-in	CPA10-EB1-HT	173 499
		For 2 coils, manual override push-in	CPA10-EB2-HT	173 502
	R	For 1 coil, manual override detenting	CPA10-EB1-HR	173 500
		For 2 coils, manual override detenting	CPA10-EB2-HR	173 503
	V	For 1 coil, manual override covered	CPA10-EB1-HV	173 501
		For 2 coils, manual override covered	CPA10-EB2-HV	173 504
Electrical interlinking block				
	-	For 1 coil	CPA10-EV1	173 505
	-	For 2 coils	CPA10-EV2	173 506

Valve terminal type 12 CPA, Compact Performance

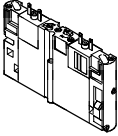
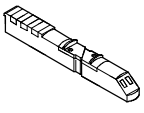

Accessories

Ordering data – CPA14				
	Code	Valve function	Type	Part No.
Equipment for valve positions				
	M/Y	5/2-way valve, single solenoid/double solenoid	CPA14-M1H-5LS	173 940
	J	5/2-way valve, double solenoid	CPA14-M1H-5JS	173 941
	B	5/3-way valve, mid-position pressurised	CPA14-M1H-5/3-BS	173 944
	G	5/3-way valve, mid-position closed	CPA14-M1H-5/3-GS	173 945
	E	5/3-way valve, mid-position exhausted	CPA14-M1H-5/3-ES	173 946
	N	2x 3/2-way valve, single solenoid, normally open	CPA14-M1H-2x3-OLS	173 942
	K	2x 3/2-way valve, single solenoid, normally closed	CPA14-M1H-2x3-GLS	173 943
	H	2x 3/2-way valve, single solenoid, 1x normally open, 1x closed	CPA14-M1H-3OLS-3GLS	175 128
Current bridge with manual override				
	N	For 1 coil, manual override push-in	CPA14-EB1-HT	173 987
		For 2 coils, manual override push-in	CPA14-EB2-HT	173 990
	R	For 1 coil, manual override detenting	CPA14-EB1-HR	173 988
		For 2 coils, manual override detenting	CPA14-EB2-HR	173 991
	V	For 1 coil, manual override covered	CPA14-EB1-HV	173 989
		For 2 coils, manual override covered	CPA14-EB2-HV	173 992
Electrical interlinking block				
	-	For 1 coil	CPA14-EV1	173 993
	-	For 2 coils	CPA14-EV2	173 994

Valve terminals for standard applications
Compact Performance

2.1





Valve terminal type 12 CPA, Compact Performance



Accessories

Valve terminals for standard applications
Compact Performance

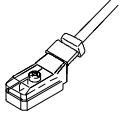
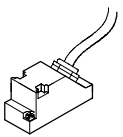
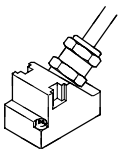







2.1

Ordering data				
	Designation	Type	Part No.	
Mounting				
	For H-rail	CPA-BG-NRH	173 498	
Inscription labels				
	6x10 in frames, 64 pieces	IBS-6x10	18 576	
Cables				
	Plug socket with cable, with integrated current reduction, 24 V DC, LED, PUR cable suitable for chain link trunking	2.5 m	KMYZ-7-24-2,5-LED-PUR	193 683
		5 m	KMYZ-7-24-5-LED-PUR	193 685
		10 m	KMYZ-7-24-10-LED-PUR	196 070
	Connecting cable, 25-pin Sub-D	5 m	KEA-1-25P-5	177 413
		10 m	KEA-1-25P-10	177 414
			KEA-1-25P-X	177 415
	Connecting cable, for chain link trunking, with 9-pin Sub-D plug, PVC cable	5 m	KMP4-9P-5-PVC	193 012
		10 m	KMP4-9P-10-PVC	193 013
	Connecting cable, for chain link trunking, with 9-pin Sub-D plug, PUR cable	5 m	KMP4-9P-5-PUR	193 014
		10 m	KMP4-9P-10-PUR	193 015
	Connecting cable, for chain link trunking, with 25-pin Sub-D plug, PVC cable	5 m	KMP4-25P-5-PVC	193 016
		10 m	KMP4-25P-10-PVC	193 017
	Connecting cable, for chain link trunking, with 25-pin Sub-D plug, PUR cable	5 m	KMP4-25P-5-PUR	193 018
		10 m	KMP4-25P-10-PUR	193 019
	Connecting cable, for chain link trunking, with 25-pin Sub-D plug, IP20, PVC cable	2.5 m	KMP6-25P-20-2,5	530 046
5 m		KMP6-25P-20-5	530 047	
10 m		KMP6-25P-20-10	530 048	
User documentation				
	CPA Pneumatics	German	P.BE-CPA-DE	173 514
		English	P.BE-CPA-EN	173 515
		French	P.BE-CPA-FR	173 516
		Italian	P.BE-CPA-IT	173 518
		Spanish	P.BE-CPA-ES	173 517
		Swedish	P.BE-CPA-SV	173 519

Valve terminal type 12 CPA, Compact Performance

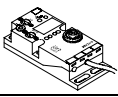
Accessories

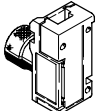

Ordering data – CPA with AS-interface			
	Designation	Type	Part No.
Bus connection			
	AS-interface flat cable, yellow, 100 m	KASI-1,5-Y-100	18 940
	AS-interface flat cable, black, 100 m	KASI-1,5-Z-100	18 941
	Flat cable socket	ASI-SD-FK	18 785
	Flat cable socket, rotatable 180°	ASI-SD-FK180	196 089
	Flat cable blanking plug	ASI-SD-FK-BL	196 090
	AS-interface flat cable distributor, cable parallel	ASI-KVT-FK	18 786
	AS-interface flat cable distributor, cable symmetrical	ASI-KVT-FK-S	18 797
	Cable distributor (yellow and black) on 2x M12, 4-pin	ASI-KVT-FKX2-M12	527 474
	Cable cap for flat cable (scope of delivery 50 pieces)	ASI-KK-FK	18 787
	Cable sleeve (scope of delivery 20 pieces)	ASI-KT-FK	165 593
	M12 socket for flat cable	ASI-SD-FK-M12	18 788
	M12 socket for flat cable, with Pg13.5	ASI-SD-PG-M12	18 789

Valve terminals for standard applications
Compact Performance

2.1











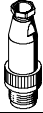
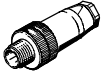

Valve terminal type 12 CPA, Compact Performance

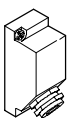
Accessories

FESTO

Valve terminals for standard applications
Compact Performance

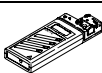
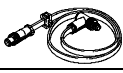
2.1

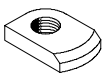
Ordering data– CPA with AS-interface			
	Designation	Type	Part No.
Sensor plug			
	Sensor plug straight, M12, 5-pin, PG7	SEA-M12-5GS-PG7	175 487
	Sensor plug straight, M12, 4-pin, PG7	SEA-GS-7	18 666
	Sensor plug straight, M12, PG9	SEA-GS-9	18 778
	Sensor plug, 4-pin, M12 for 2.5 mm cable Ø	SEA-4GS-7-2,5	192 008
	Sensor plug, straight, M8, screw-in	SEA-3GS-M8-S	192 009
	Sensor plug, straight, M8, solderable	SEA-GS-M8	18 696
	Sensor plug, Harax 4-pin	SEA-GS-HAR-4POL	525 928
	Sub-D plug, 25-pin	SD-SUB-D-ST25	527 522
	Protective cap M12	ISK-M12	165 592
	Protective cap M8	ISK-M8	177 672
DUO plug			
	DUO plug M12, for 2 cables, 5-pin	SEA-5GS-11-DUO	192 010
	DUO plug M12, for 2 cables, 4-pin	SEA-GS-11-DUO	18 779
DUO cable M12 on 2x M8			
	DUO cable, 2x straight socket	KM12-DUO-M8-GDGD	18 685
	DUO cable, 2x straight/angled socket	KM12-DUO-M8-GDWD	18 688
	DUO cable, 2x angled socket	KM12-DUO-M8-WDWD	18 687
Extension cable			
	Extension cable, 4-pin, 2.5 m	KM12-M12-GSGD-2,5	18 684
	Extension cable, 4-pin, 5 m	KM12-M12-GSGD-5	18 686
Miscellaneous			
	Combi power pack for AS-interface	ASI-CNT-115/230 VAC-B	191 082
	Addressing device	ASI-PRG-ADR	18 959
	Addressing cable	KASI-ADR	18 960
	Inscription labels 6x10 in frames (64 pieces)	IBS 6x10	18 576
	Inscription labels 9x20 in frames (20 pieces)	IBS 9x20	18 182
	Attachment for H-rail mounting	CPA-BG-NRH	173 498