







- 3 thread types – M, R, and G thread
- 360° rotatable
- R-threads can be re-used up to five times.

Self-closing/rotary push-in fittings QS, Quick Star

Key features



Application	Simply "plug and work"	Reliably connected	Captive seal
 <p>Effortless selection of the right fitting. Quick Star offers a secure solution for every connection. The convenient push-in fitting system includes well over 1000 types of standard and function fittings.</p>	 <p>The stainless steel retaining ring within the fitting holds the tubing securely without damaging its surface. Vibration and pressure surges are safely absorbed. The tubing can be detached easily by pressing down the blue release ring. For your convenience, the appropriate outside tubing diameter is marked on the release ring.</p>	 <p>A nitrile rubber sealing ring guarantees a perfect seal between standard OD tubing and the body of the fitting. Standard tubing is suitable for use with compressed air and vacuum.</p>	 <p>All of the brass components included in Festo's push-in fittings are nickel plated and are thus highly resistant to corrosion. The tapered ISO R threads have a self-sealing PTFE coating, which allows the fitting to be re-used up to five times without the need for additional sealing components.</p>

360° rotatable	360° rotatable, with ball bearing
 <p>Alignment is performed during assembly. Tube movement is compensated during use.</p>	 <p>Permits rotating motion of up to 500 rpm during use.</p>

Which fitting fits which thread?		
<p>Metric thread</p> <ul style="list-style-type: none"> Cylindrical metric thread is comparable with G-thread Sealing is guaranteed by a clip-on O-ring 	<p>G thread to DIN ISO 228-1</p> <ul style="list-style-type: none"> Shorter thread Constant installation depth Replaceable sealing ring Sealing at front Can be re-used a number of times thanks to replaceable sealing ring 	<p>R thread to DIN 2999-1 und ISO 7/1</p> <ul style="list-style-type: none"> Self-sealing thread Sealing on the threads No additional sealing surface required Smaller installation dimensions since there is no need for a rebate for the sealing surface Can be re-used up to five times

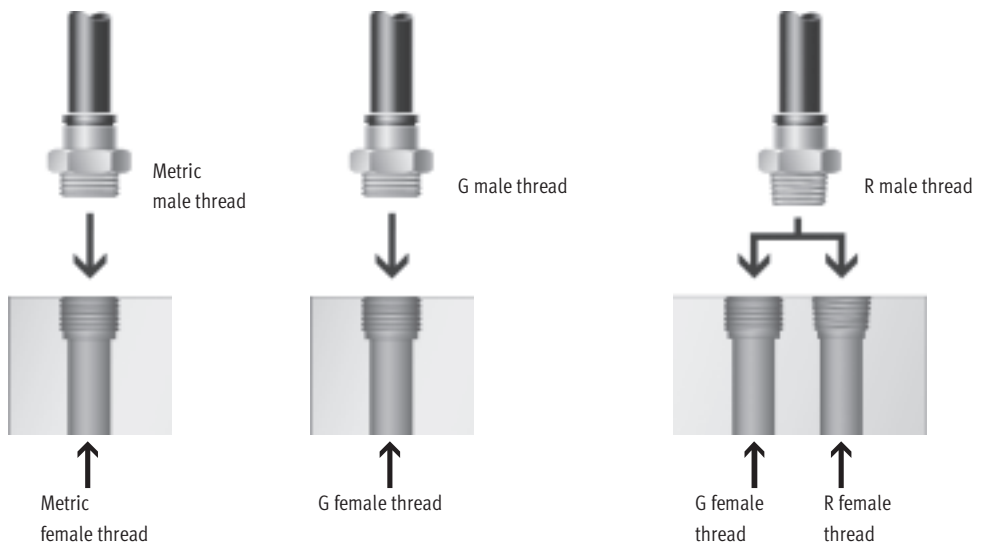

Piping, tubing and fittings
Function fittings

5.6

Self-closing/rotary push-in fittings QS, Quick Star

Technical data

Materials

Sectional view

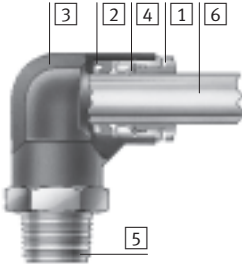

	Standard QS
1 Release ring	Polyacetate
2 Seal	Nitrile rubber
3 Housing	Polybuteneterephthalate Nickel plated brass
4 Tube clamping segment	High alloy stainless steel
5 Threaded coupling	Nickel plated brass PTFE sealing compound
6 Plastic tubing, standard O.D.	PAN PUN PUN-H PUN-E
Note on materials	RoHS-conform

Tubing insertion depth



Tubing O.D. [mm]	4	6	8	10	12
Standard QSK	12.5 (QSSK: 15)	13.5 (QSSK: 17)	19 (QSK-1/8: 22)	21 (QSK-1/4: 25)	23 (QSK-3/8: 29)
Standard QSR	16	17	19	21	23

Operating and environmental conditions

	Standard QSK	Standard QSR
Temperature dependent operating pressure [bar]	-0.95 ... +14	
Operating temperature [°C]	-10 ... +80	
Corrosion resistance CRC ¹⁾	1	
Certification	Germanischer Lloyd	

1) Corrosion resistance class 1 according to Festo standard 940 070
Components requiring low corrosion resistance. Transport and storage protection. Parts that do not have primarily decorative surface requirements, e.g. in internal areas that are not visible or behind covers.

Operating pressure p as a function of temperature t

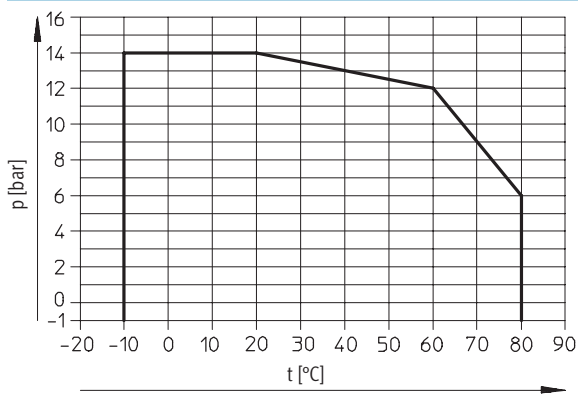

Self-closing/rotary push-in fittings QS, Quick Star

Technical data







Possible push-in fitting/tubing combinations					
Thread	Tubing O.D. [mm]				
	4	6	8	10	12
M5	++	+	-	-	-
R $\frac{1}{8}$	+	++	+	+	-
R $\frac{1}{4}$	+	+	++	+	+
R $\frac{3}{8}$	-	+	+	++	+
R $\frac{1}{2}$	-	-	-	+	++
G $\frac{1}{8}$	+	++	+	-	-
G $\frac{1}{4}$	-	+	++	+	+
G $\frac{3}{8}$	-	-	+	++	+
G $\frac{1}{2}$	-	-	-	-	++

- + Possible thread/tubing O.D. combinations
- ++ Optimum thread/tubing O.D. combinations (with regard to flow)

Self-closing/rotary push-in fittings QS, Quick Star

Product range overview



Shape	Design	Type	Connection D1				Connection D2		→ Page
			M thread	R thread	G thread	Tubing O.D.	Tubing O.D.		
Straight	Self-closing push-in fitting – Male thread with external hex								
		QSK	M5	–	–	–	–	4, 6	3 / 5.6-6
				R $\frac{1}{8}$	G $\frac{1}{8}$	4, 6, 8			
				R $\frac{1}{4}$	G $\frac{1}{4}$	6, 8, 10			
				R $\frac{3}{8}$	G $\frac{3}{8}$	8, 10, 12			
				R $\frac{1}{2}$	G $\frac{1}{2}$	12			
	Self-closing push-in connector								
		QSK	–	–	–	–	4	–	3 / 5.6-7
							6		
							8		
							10		
							12		
Push-in bulkhead connector									
	QSSK	–	–	–	–	4	–	3 / 5.6-8	
						6			
						8			
						10			
						12			
Rotary push-in fitting, rotatable 360° via ball bearing – Male thread with external hex									
	QSR	M5	–	–	–	–	4, 6	3 / 5.6-11	
			R $\frac{1}{8}$	G $\frac{1}{8}$	4, 6, 8				
			R $\frac{1}{4}$	G $\frac{1}{4}$	6, 8				
			R $\frac{3}{8}$	G $\frac{3}{8}$	8, 10, 12				
			R $\frac{1}{2}$	G $\frac{1}{2}$	12				
L-shape	Self-closing push-in L-fitting – can be turned 360° – Male thread with external hex								
		QSRL	M5	–	–	–	–	4, 6	3 / 5.6-9
				R $\frac{1}{8}$	G $\frac{1}{8}$	4, 6, 8			
				R $\frac{1}{4}$	G $\frac{1}{4}$	6, 8, 10			
				R $\frac{3}{8}$	G $\frac{3}{8}$	8, 10, 12			
				R $\frac{1}{2}$	G $\frac{1}{2}$	12			
	Rotary push-in L-fitting, rotatable 360° via ball bearing – Male thread with external hex								
		QSRL	M5	–	–	–	–	4, 6	3 / 5.6-10
				R $\frac{1}{8}$	G $\frac{1}{8}$	4, 6, 8			
				R $\frac{1}{4}$	G $\frac{1}{4}$	6, 8			
				R $\frac{3}{8}$	G $\frac{3}{8}$	8, 10, 12			
				R $\frac{1}{2}$	G $\frac{1}{2}$	12			

Self-closing push-in fittings QSK, Quick Star

Technical data



Self-closing push-in fitting QSK

Male thread
with external hex

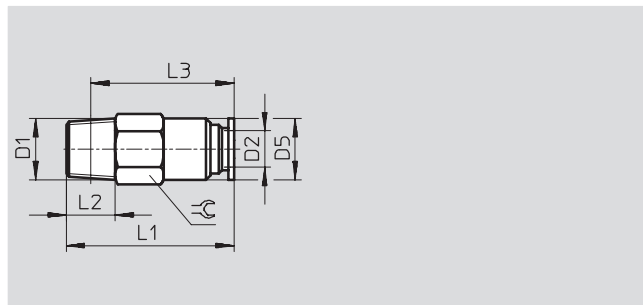
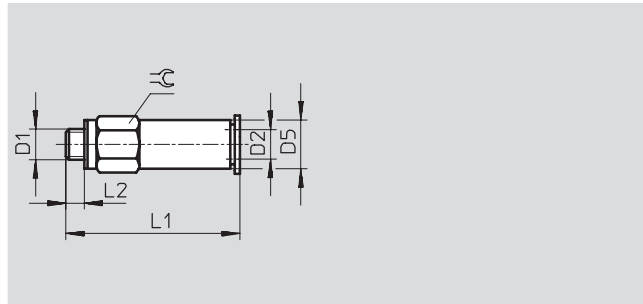

Dimensions and ordering data											
Connection	Nominal size	Tubing O.D.	D5 ∅	L1	L2	L3	⌀	Weight/ piece [g]	Part No.	Type	PU*
D1	[mm]	D2									
Metric thread with sealing ring											
M5	1.4	4	8	29.5	3.5	-	8	7.1	153 291	QSK-M5-4	1
	1.7	6	10	32.5	3.5	-	10	12	153 292	QSK-M5-6	1
R thread											
R $\frac{1}{8}$	1.6	4	9	25	8	20	10	9.5	153 419	QSK- $\frac{1}{8}$ -4	1
	3	6	10	27.5	8	23	10	9.5	153 420	QSK- $\frac{1}{8}$ -6	1
	3.4	8	14	36	8	32	14	22.5	153 422	QSK- $\frac{1}{8}$ -8	1
R $\frac{1}{4}$	3	6	12	27.5	11	21	14	21	153 421	QSK- $\frac{1}{4}$ -6	1
	4.3	8	14	36	11	30	14	22.5	153 423	QSK- $\frac{1}{4}$ -8	1
	4.8	10	17	38.5	11	32.5	17	32	153 425	QSK- $\frac{1}{4}$ -10	1
R $\frac{3}{8}$	4.5	8	15	36	12	29.5	17	39	153 424	QSK- $\frac{3}{8}$ -8	1
	5.6	10	17	40	12	33.5	17	35	153 426	QSK- $\frac{3}{8}$ -10	1
	6.1	12	21	46	12	39.5	21	63.5	153 427	QSK- $\frac{3}{8}$ -12	1
R $\frac{1}{2}$	6.4	12	21	46	15	38	21	65.5	153 428	QSK- $\frac{1}{2}$ -12	1

* Packaging unit quantity

Self-closing push-in fittings QSK, Quick Star

Technical data

Self-closing push-in fitting QSK

Male thread with external hex

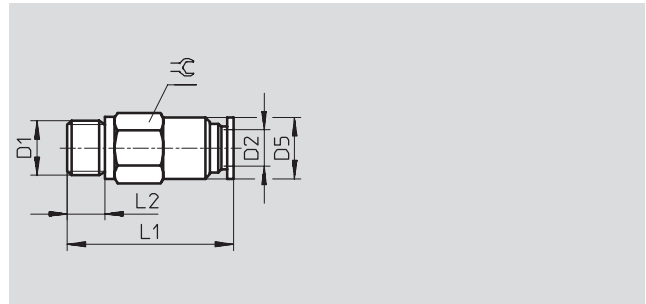

Dimensions and ordering data										
Connection	Nominal size	Tubing O.D.	D5	L1	L2	≅	Weight/piece	Part No.	Type	PU*
D1	[mm]	D2	∅				[g]			
G thread with sealing ring										
G ¹ / ₈	1.6	4	8.8	23.5	5.1	13	14	186 294	QSK-G ¹ / ₈ -4	1
	3	6	10	26.2	5.1	13	14	186 295	QSK-G ¹ / ₈ -6	1
	3.4	8	14	34.7	5.1	14	23	186 297	QSK-G ¹ / ₈ -8	1
G ¹ / ₄	3	6	12	25.6	5.6	17	26	186 296	QSK-G ¹ / ₄ -6	1
	4.3	8	14	34.5	5.6	17	30	186 298	QSK-G ¹ / ₄ -8	1
	4.8	10	17	36.8	5.6	17	33	186 300	QSK-G ¹ / ₄ -10	1
G ³ / ₈	4.5	8	15	34.5	6.6	19	43	186 299	QSK-G ³ / ₈ -8	1
	5.6	10	17	38.3	6.6	19	41	186 301	QSK-G ³ / ₈ -10	1
	6.1	12	20.8	43.3	6.6	21	63	186 302	QSK-G ³ / ₈ -12	1
G ¹ / ₂	6.4	12	20.8	44.9	7.6	24	78	186 303	QSK-G ¹ / ₂ -12	1

* Packaging unit quantity

Self-closing push-in fittings QSK/QSSK, Quick Star

Technical data

Self-closing push-in connector QSK

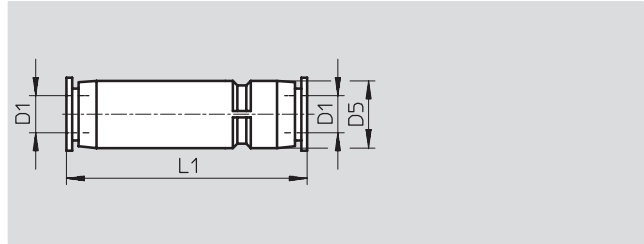



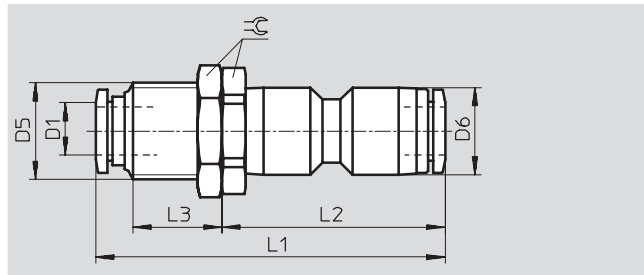

Dimensions and ordering data							
Tubing O.D. D1	Nominal size [mm]	D5 Ø	L1	Weight/piece [g]	Part No.	Type	PU*
4	1.6	8.5	36	3.5	153 439	QSK-4	1
6	3	11	39.5	6	153 440	QSK-6	1
8	4.4	14.5	54.5	16	153 441	QSK-8	1
10	5.3	17.5	60.5	26	153 442	QSK-10	1
12	6.2	21	70.5	40.5	153 443	QSK-12	1

* Packaging unit quantity

Push-in bulkhead connector QSSK



Dimensions and ordering data											
Tubing O.D. D1	Nominal size [mm]	D5 Ø	D6 Ø	L1	L2	L3	⌀	Weight/ piece [g]	Part No.	Type	PU*
4	1.5	M10x1	10	43.1	29.6	10	12	14	130 637	QSSK-4	 New 10
6	3	M12x1	12.5	47.6	34.2	9.9	14	20	130 638	QSSK-6	 New 10
8	4.3	M16x1	14.5	58.1	37.1	14.7	19	38	130 639	QSSK-8	 New 10
10	5.4	M20x1	17.5	66.5	43.4	16.2	24	68	130 640	QSSK-10	 New 1
12	6.3	M22x1	21	75.5	48.6	20.7	27	98	130 641	QSSK-12	 New 1

* Packaging unit quantity

Self-closing push-in fittings QSKL, Quick Star

Technical data



Self-closing push-in L-fitting QSKL

360° rotatable
Male thread
with external hex



M thread

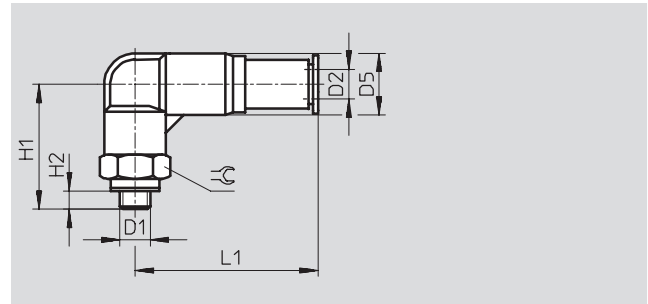

R thread

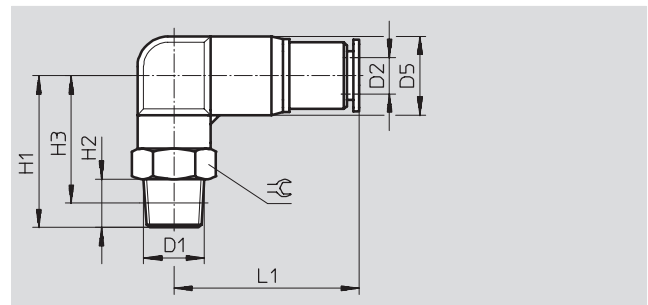

Dimensions and ordering data												
Connection	Nominal size	Tubing O.D.	D5	H1	H2	H3	L1	⌀	Weight/ piece	Part No.	Type	PU*
D1	[mm]	D2	∅						[g]			
Metric thread with sealing ring												
M5	1.4	4	10	20.8	3.5	–	30.3	10	13	153 294	QSKL-M5-4	1
	1.7	6	12.5	22.5	3.5	–	30.4	12	20	153 295	QSKL-M5-6	1
R thread												
R ¹ / ₈	1.5	4	10	23.5	8	19.5	30.5	10	17	153 429	QSKL- ¹ / ₈ -4	1
	3	6	12.5	25	8	21	30.5	12	22	153 430	QSKL- ¹ / ₈ -6	1
	4.2	8	14.5	28	8	24	43	14	34	153 432	QSKL- ¹ / ₈ -8	1
R ¹ / ₄	3.2	6	12.5	28	11	22	30.5	14	29.5	153 431	QSKL- ¹ / ₄ -6	1
	4.1	8	14.5	31	11	25	43	14	40	153 433	QSKL- ¹ / ₄ -8	1
	5.2	10	17.5	36	11	30	49.5	17	58.5	153 435	QSKL- ¹ / ₄ -10	1
R ³ / ₈	4.3	8	14.5	33	12	26.5	43	17	53	153 434	QSKL- ³ / ₈ -8	1
	5.3	10	17.5	37	12	30.5	49.5	17	67	153 436	QSKL- ³ / ₈ -10	1
	6.2	12	21	39	12	32.5	57.5	21	92.5	153 437	QSKL- ³ / ₈ -12	1
R ¹ / ₂	6.2	12	21	42	15	34	57.5	21	107	153 438	QSKL- ¹ / ₂ -12	1

* Packaging unit quantity

Self-closing push-in fittings QSKL, Quick Star



Technical data

Self-closing push-in L-fitting QSKL-...

360° rotatable
Male thread
with external hex

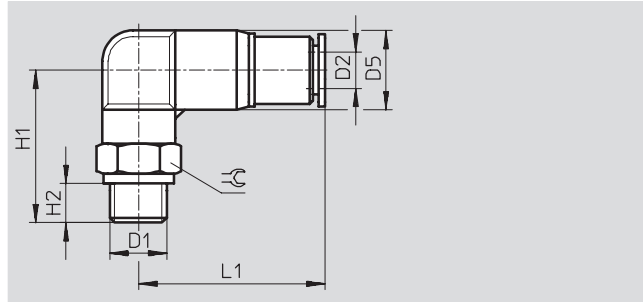

Dimensions and ordering data											
Connection	Nominal size	Tubing O.D.	D5	H1	H2	L1	≅	Weight/ piece	Part No.	Type	PU*
D1	[mm]	D2	∅					[g]			
G thread with sealing ring											
G ¹ / ₈	1.5	4	10	23.3	5.1	30.3	13	19	186 304	QSKL-G ¹ / ₈ -4	1
	2.9	6	12.5	24	5.1	30.4	13	22	186 305	QSKL-G ¹ / ₈ -6	1
	4.2	8	14.5	27	5.1	43	14	34	186 307	QSKL-G ¹ / ₈ -8	1
G ¹ / ₄	3.2	6	12.5	25.5	5.6	30.4	17	31	186 306	QSKL-G ¹ / ₄ -6	1
	4.1	8	14.5	28.5	5.6	43	17	43	186 308	QSKL-G ¹ / ₄ -8	1
	5.2	10	17.5	32.5	5.6	49.3	17	57	186 310	QSKL-G ¹ / ₄ -10	1
G ³ / ₈	4.3	8	14.5	30	6.6	43	19	56	186 309	QSKL-G ³ / ₈ -8	1
	5.3	10	17.5	34	6.6	49.3	19	66	186 311	QSKL-G ³ / ₈ -10	1
	6.2	12	21	36	6.6	57.1	21	86	186 312	QSKL-G ³ / ₈ -12	1
G ¹ / ₂	6.2	12	21	39	7.6	57.1	24	112	186 313	QSKL-G ¹ / ₂ -12	1

* Packaging unit quantity

Rotary push-in fittings QSR, Quick Star

Technical data



Rotary push-in fitting QSR

Rotatable 360°
via ball bearing
Male thread with
external hex



M thread

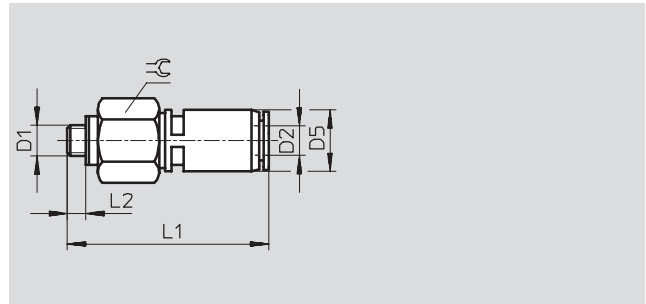

R thread

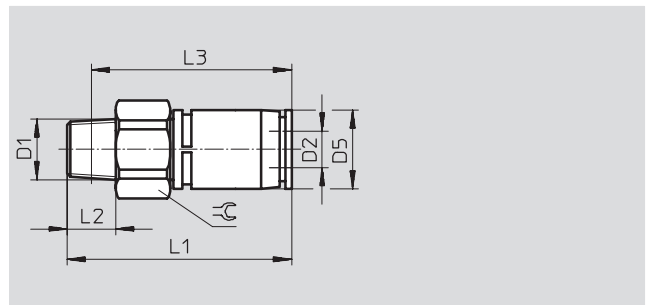

Dimensions and ordering data												
Connection	Nominal size	Tubing O.D.	Rotational speed	D5	L1	L2	L3	⌀	Weight/ piece	Part No.	Type	PU*
D1	[mm]	D2	[rpm]	∅					[g]			
Metric thread with sealing ring												
M5	1.6	4	500	10	33.1	3.5	-	12	13	153 526	QSR-M5-4	1
	1.6	6	500	12.5	36.7	3.5	-	14	19	153 527	QSR-M5-6	1
R thread												
R1/8	2.1	4	500	10	34.1	8	30.1	12	14	153 401	QSR-1/8-4	1
	3.4	6	500	12.5	36.9	8	32.9	14	18	153 402	QSR-1/8-6	1
	5	8	400	14.5	45.3	8	41.3	17	34	153 404	QSR-1/8-8	1
R1/4	3.4	6	500	12.5	38.9	11	32.8	14	23	153 403	QSR-1/4-6	1
	5	8	400	14.5	44.3	11	38.3	17	32	153 405	QSR-1/4-8	1
R3/8	5	8	400	14.5	44.3	12	38	17	39	153 406	QSR-3/8-8	1
	6.7	10	300	18	55.8	12	49.5	22	61	153 407	QSR-3/8-10	1
	8	12	250	21	63.2	12	56.9	24	82	153 408	QSR-3/8-12	1
R1/2	8	12	250	21	63.2	15	55	24	89	153 409	QSR-1/2-12	1

* Packaging unit quantity

Rotary push-in fittings QSR, Quick Star

Technical data



Rotary push-in fitting QSR

Rotatable 360°
via ball bearing
for plastic tubing
with standard O.D.



G thread

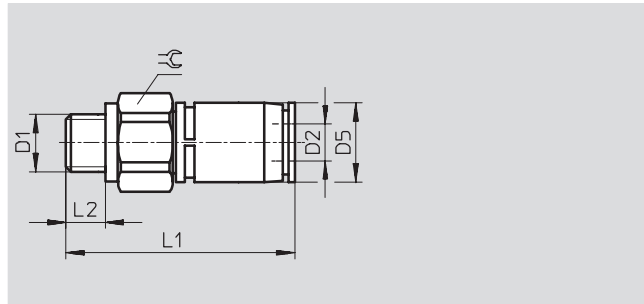

Dimensions and ordering data											
Connection	Nominal size	Tubing O.D.	Rotational speed	D5	L1	L2	≅	Weight/ piece	Part No.	Type	PU*
D1	[mm]	D2	[rpm]	∅				[g]			
G thread with sealing ring											
G1/8	2.1	4	500	10	33.1	5.1	13	15	186 276	QSR-G1/8-4	1
	3.4	6	500	12.5	35.9	5.1	14	17	186 277	QSR-G1/8-6	1
	5	8	400	14.5	44.3	5.1	17	34	186 279	QSR-G1/8-8	1
G1/4	3.4	6	500	12.5	35.4	5.6	17	24	186 278	QSR-G1/4-6	1
	5	8	400	14.5	40.8	5.6	17	30	186 280	QSR-G1/4-8	1
G3/8	5	8	400	14.5	41.3	6.6	19	40	186 281	QSR-G3/8-8	1
	6.7	10	300	18	53.8	6.6	22	59	186 282	QSR-G3/8-10	1
	8	12	200	21	60.2	6.6	23.8	78	186 283	QSR-G3/8-12	1
G1/2	8	12	200	21	58.2	7.6	23.8	79	186 284	QSR-G1/2-12	1

* Packaging unit quantity

Rotary push-in fittings QSRL, Quick Star

Technical data



Rotary push-in L-fitting QSRL

Rotatable 360°
via ball bearing
Male thread
with external hex

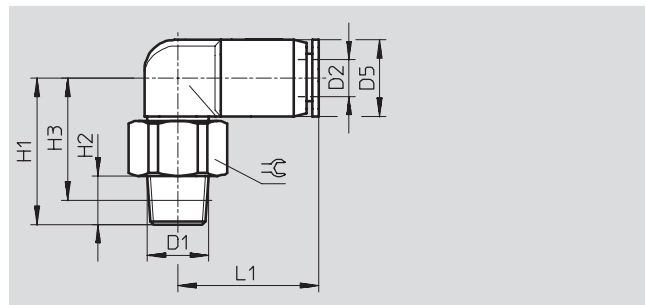
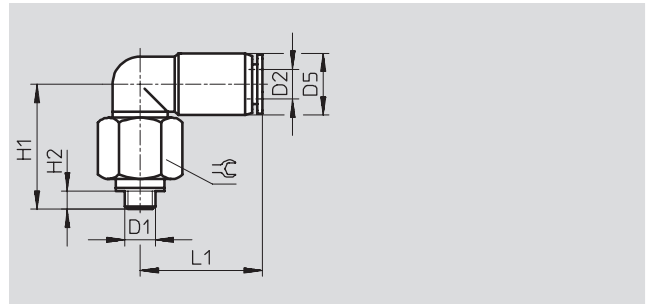

Dimensions and ordering data													
Connection	Nominal size	Tubing O.D.	Rotational speed	D5	H1	H2	H3	L1	⌀	Weight/ piece	Part No.	Type	PU*
D1	[mm]	D2	[rpm]	∅						[g]			
Metric thread with sealing ring													
M5	1.4	4	500	10	21	3.5	-	19.7	12	13	153 529	QSRL-M5-4	1
	1.6	6	500	12.5	23.8	3.5	-	22.8	14	20	153 530	QSRL-M5-6	1
R thread													
R $\frac{1}{8}$	1.8	4	500	10	23	8	18	20	12	15	153 410	QSRL- $\frac{1}{8}$ -4	1
	3.1	6	500	12.5	24	8	20	23	14	19	153 411	QSRL- $\frac{1}{8}$ -6	1
	4.6	8	400	14.5	31.5	8	27.5	26	14	33	153 413	QSRL- $\frac{1}{8}$ -8	1
R $\frac{1}{4}$	3.1	6	500	12.5	26	11	20	23	14	23	153 412	QSRL- $\frac{1}{4}$ -6	1
	4.6	8	400	14.5	30.5	11	24.5	26	17	32	153 414	QSRL- $\frac{1}{4}$ -8	1
R $\frac{3}{8}$	4.6	8	400	14.5	30.5	12	24	26	17	39	153 415	QSRL- $\frac{3}{8}$ -8	1
	6.2	10	300	17.5	36	12	29.5	30	22	56	153 416	QSRL- $\frac{3}{8}$ -10	1
	7.4	12	250	21	41.5	12	35	33	24	84	153 417	QSRL- $\frac{3}{8}$ -12	1
R $\frac{1}{2}$	7.4	12	250	21	41.5	15	33.5	33	24	90	153 418	QSRL- $\frac{1}{2}$ -12	1

* Packaging unit quantity

Rotary push-in fittings QSRL, Quick Star

Technical data



Rotary push-in L-fitting QSRL

Rotatable 360°
via ball bearing
Male thread
with external hex



G thread

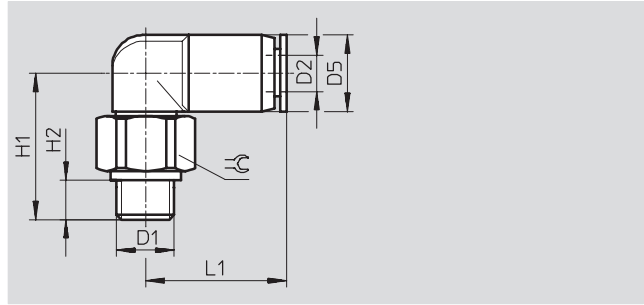

Dimensions and ordering data												
Connection	Nominal size	Tubing O.D.	Rotational speed	D5	H1	H2	L1	∅	Weight/ piece	Part No.	Type	PU*
D1	[mm]	D2	[rpm]	∅					[g]			
G thread with sealing ring												
G ¹ / ₈	1.9	4	500	10	21	5.1	19.7	13	15	186 285	QSRL-G¹/₈-4	1
	3.1	6	500	12.5	23	5.1	22.8	14	18	186 286	QSRL-G¹/₈-6	1
	4.6	8	400	14.5	30.5	5.1	25.7	17	35	186 288	QSRL-G¹/₈-8	1
G ¹ / ₄	3.1	6	500	12.5	22.5	5.6	22.8	17	25	186 287	QSRL-G¹/₄-6	1
	4.6	8	400	14.5	27	5.6	25.7	17	31	186 289	QSRL-G¹/₄-8	1
G ³ / ₈	4.6	8	400	14.5	27.5	6.6	25.7	19	41	186 290	QSRL-G³/₈-8	1
	6.2	10	300	17.5	33.3	6.6	29.5	22	59	186 291	QSRL-G³/₈-10	1
	7.4	12	200	21	38.5	6.6	32.7	24	81	186 292	QSRL-G³/₈-12	1
G ¹ / ₂	7.4	12	200	21	36.5	7.6	32.7	24	81	186 293	QSRL-G¹/₂-12	1

* Packaging unit quantity



- **Single and multiple rotary distributors**
- **Sturdy thanks to dual bearings for absorbing lateral forces**
- **Seal for gaseous and liquid media**
- **Flexible installation thanks to radial and axial connection**

Rotary distributors GF

Product range overview

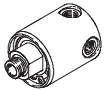
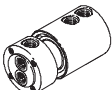

Design	Version	Type	Connection D1	Connection D2	Max. speed [rpm]	→ Page
				Outlet		
Simple	4 outlets					
		GF	G1/8	M5	3000	3 / 5.6-18
			G1/4	G1/8		
			G1/2	G1/4	2500	
Multiple	2 axial and radial outlets					
		GF	G1/8	G1/8	300	3 / 5.6-19
			G1/4	G1/4		
			G1/2	G1/2		

Rotary distributors GF

Type codes

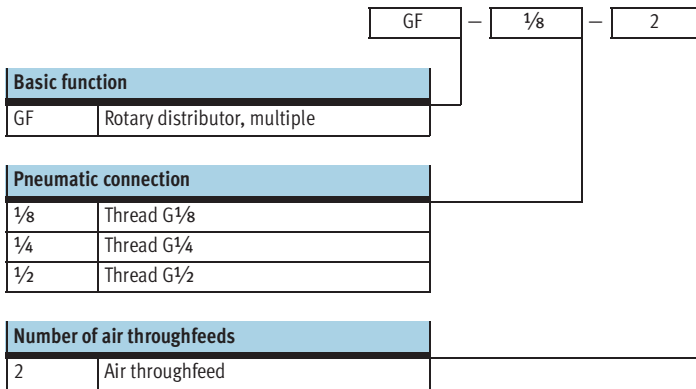
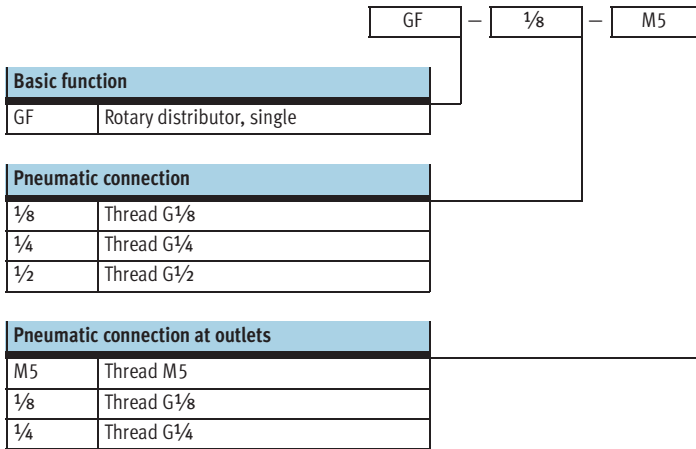

Rotary distributors GF

Technical data



Rotary distributor GF, single
4 outlets

- - Temperature range
-10 ... +80 °C

- - Pressure
-0.95 ... +10 bar

Materials:
Housing: Brass
Shaft: High-alloy steel



Technical data			
Pneumatic connection	G1/8	G1/4	G1/2
Operating medium	Filtered compressed air		
Operating pressure [bar]	-0.95 ... +10		
Ambient temperature [°C]	-10 ... +80		
Assembly position	Any		
Corrosion resistance class [CRC] ¹⁾	1		
Max. speed [rpm]	3000	3000	2500
Max. tightening torque [Nm]	10	15	40
Product weight [g]	400	370	1200

1) Corrosion resistance class 1 according to Festo standard 940 070
Components requiring low corrosion resistance. Transport and storage protection. Parts that do not have primarily decorative surface requirements, e.g. in internal areas that are not visible or behind covers.

Dimensions and ordering data Download CAD data → www.festo.com/en/engineering

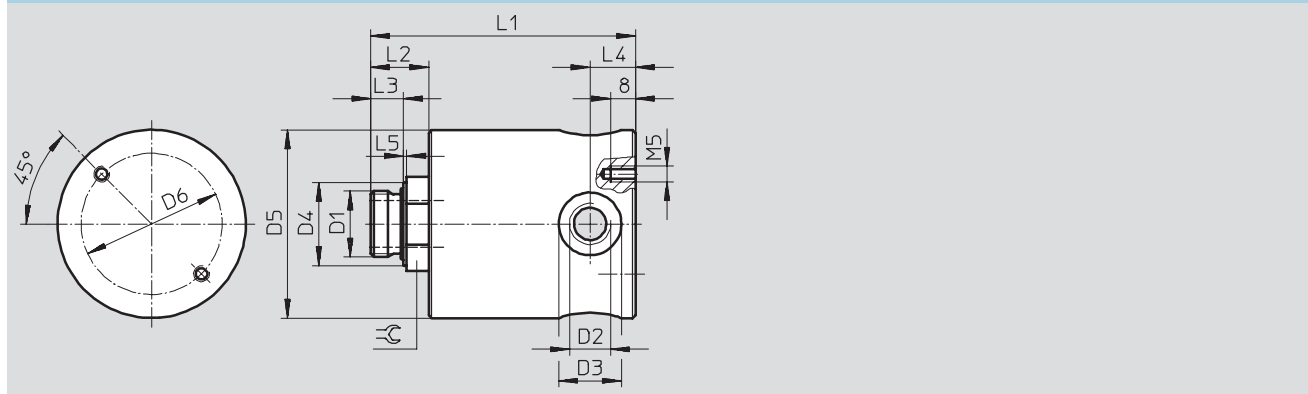

Pneumatic connection	Pneumatic connection at outlets	Nominal size	D3	D4	D5	D6	L1
D1	D2	[mm]	∅	∅	∅ -1	∅	
G1/8	M5	6	9	14.5	40	30	64
G1/4	G1/8	8	16	17	40	30	65.5
G1/2	G1/4	15	20	26.5	60	45	90

Pneumatic connection	L2	L3	L4	L5	⊕	Part No.	Type
D1							
G1/8	15.5	6.5	7	1	17	539 290	GF-1/8-M5
G1/4	17	8	9.5	1.5	17	539 291	GF-1/4-1/8
G1/2	24	10.5	14.5	1.5	27	539 292	GF-1/2-1/4

Rotary distributors GF

Technical data



Rotary distributor GF, multiple
2 axial and radial outlets

- - Temperature range
-10 ... +80 °C
- - Pressure
-0.95 ... +10 bar

Materials:
Housing: Brass
Shaft: High-alloy steel



Technical data			
Pneumatic connection	G1/8	G1/4	G1/2
Operating medium	Filtered compressed air		
Operating pressure [bar]	-0.95 ... +10		
Ambient temperature [°C]	-10 ... +80		
Assembly position	Any		
Corrosion resistance class [CRC] ¹⁾	1		
Max. speed [rpm]	300		
Max. tightening torque [Nm]	10	15	40
Product weight [g]	1800	2950	7400

1) Corrosion resistance class 1 according to Festo standard 940 070
Components requiring low corrosion resistance. Transport and storage protection. Parts that do not have primarily decorative surface requirements, e.g. in internal areas that are not visible or behind covers.

Dimensions and ordering data Download CAD data → www.festo.com/en/engineering

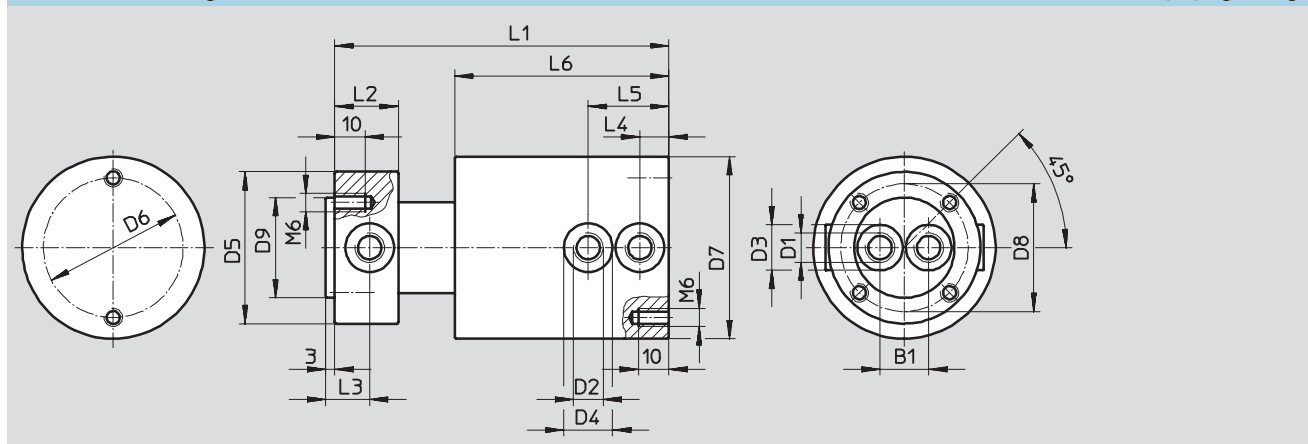

Pneumatic connection	Pneumatic connection at outlets	Nominal size	B1	D3	D4	D5	D6	D7	D8
D1	D2	[mm]		∅	∅	∅	∅	∅	∅
G1/8	G1/8	4.1	16	15	16	50	46	60	42
G1/4	G1/4	8	20	19	20	65	46	70	50
G1/2	G1/2	12.75	30	28	28	90	65	95	78

Pneumatic connection	D9	L1	L2	L3	L4	L5	L6	Part No.	Type
D1	∅								
G1/8	f7								
G1/8	33	113	21	14.5	9.5	26.5	70.5	539 287	GF-1/8-2
G1/4	40	131	28	19.5	13.5	34.5	81.5	539 288	GF-1/4-2
G1/2	65	174	39	25.5	17.5	49.5	112	539 289	GF-1/2-2