

Adsorption dryer LDF

Features

FESTO



Small unit – big effect

Cold-regenerating adsorption dryer with defined pressure dew point and high flow rate for decentralised compressed air drying.

The LDF adsorption dryer effectively prevents corrosion, wear, excessive product wastage, frequent maintenance and damage to sensitive machinery.

- The solution for dry and clean compressed air
- Greater service life of pneumatic components
- Pressure dew point $-40\text{ }^{\circ}\text{C}$, ($-70\text{ }^{\circ}\text{C}$ on request)
- Additional filtering of oil and particulate
- Produced for decentralised compressed air drying
- High flow rate performance up to 1,600 l/min
- Low energy consumption and noise levels
- In combination with a prefilter and secondary filter, this achieves air purity class 2.2.1 or 2.1.1 to DIN ISO 8573-1 at the outlet.

- Of particular interest for printed circuit production, optical industries, foil production, dental technology, drying and transportation of powder materials, paint systems, drying and cleaning precision parts, food industry and pharmaceuticals.

Decentralised drying

Partial drying is already started in the after-cooler. Actual drying can be centralised in the compressor room or decentralised as required with the

consuming devices using compact Festo LDF-H... adsorption dryers. Decentralised drying is advantageous because only the actually required

amount of dry air is prepared. Pressure dew points of less than $0\text{ }^{\circ}\text{C}$ always require the utilisation of adsorption dryers.

Constant air quality

The drying granulate is introduced into the dryer in such a way as to ensure even and compact filling.

Adsorption dryer LDF

Key features and type code



Reduces energy costs	Reduced service costs		Complete drying package
The dryers have a low differential pressure.	The dryer granulate has a long service life (approx. 15,000 operating hours). When refilling the dryer, the Festo	filling funnel must be used to ensure that the filling density in the chambers is optimal.	These dryers are fitted as standard with coalescing filters.

Function			
The airflow is filtered in the inlet filter (oil would considerably reduce the granulate service life). The adsorption dryer consists of two chambers filled with drying agent. Moist compressed air flows through the two chambers alternately, and the water from the air accumulates on the surface of the drying agent. After a predetermined period of time, the flow of air is	switched to the other chamber and a portion of the dried air is used to regenerate the drying agent in the first chamber. The drying agent has a service life of several years. The standard LDF dryers achieve a pressure dew point of -40 °C (air purity class 2.2.1 to DIN ISO 8573-1 at the outlet).	An appropriate drying agent is used with dryers which have a pressure dew point of up to -70 °C (air purity class 2.1.1 to DIN ISO 8573-1 at the outlet) (upon request). The pressure dew point should be about 10 °C less than the anticipated ambient temperature. The application area for the adsorption dryer is decentralised compressed	air preparation. The purge air requirement at the optimal operating point (6 bar/35 °C) is approx. 22%. If the dryer is used under different operating conditions, the input air/purge air ratio may change as the purge air consumption is only dependent on the input air and not on the used output flow rate.

Important			
The supplied inlet filter, a 0.01 µm micro filter, provides clean operating air. It protects the drying agents from contaminating dirt and oil particles.	The outlet filter, a 1 µm fine filter, removes any drying agent particles. The inlet filter cannot remove gaseous	components, such as water and oil vapour, from the air. However, this is achieved by the highly porous drying	granulate. It is for this reason that the LDF-H dryer achieves the highest air quality class for particles and oil.

Type codes



Basic function	
LDF	Adsorption dryer

Differential pressure [mbar]	
H1	50
H2	150
H3	500
H4	250
H5	350
H6	600
H7	900

Pneumatic connection	
1/4	Thread G1/4
1/2	G1/2 thread

Voltage	
	24 V DC, 110/230 V AC
24	24 V DC
110	110 V AC
230	230 V AC

Individual units
Dryers
4.5



Adsorption dryer LDF

Technical data

FESTO

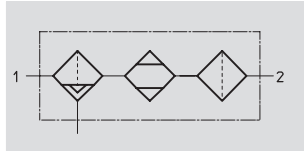
Function



-  Flow rate
26 ... 1,600 l/min
-  Temperature range
2 ... 50 °C
-  Input pressure
4 ... 10.5 bar



General technical data								
Variant	H1	H2	H3	H4	H5	H6	H7	
Pneumatic connection	G $\frac{1}{4}$			G $\frac{1}{2}$				
Design	Cold regenerating compressed air adsorption dryer							
Type of mounting	Through-hole							
Mounting position	Vertical $\pm 5^\circ$							
Pressure dew point	[°C]	-40 (-70 on request)						
Differential pressure	[mbar]	50	150	500	250	350	600	900
Air purity class at the outlet	2.2.1 to DIN ISO 8573-1 (2.1.1 to DIN ISO 8573-1 upon request)							
Electrical data								
Electrical connection	With plug socket to DIN 43 650 type A (MSSD-C → Volume 2)			With screw terminals				
Power consumption	DC	2.5 W			5 W			
	AC	50 Hz: 5 VA			110 V: 0.27 A			
60 Hz: 3.7 VA			230 V: 0.12 A					
Protection against polarity reversal	At 24 V DC							
Protection class	IP65 to DIN 40 050							
Materials								
Housing	Zinc die-casting							
Note on materials	Free of copper and PTFE			-				

Operating and environmental conditions	
Input pressure	[bar] 4 ... 10.5
Operating medium	Compressed air, filtered, unlubricated
Ambient temperature	[°C] 2 ... 50
Media temperature	[°C] 2 ... 50
Storage temperature	[°C] -20 ... +60
Corrosion resistance	CRC ¹⁾ 1
CE symbol	In accordance with EU EMC Directive
(see declaration of conformity)	In accordance with EU Low Voltage Directive (all types except LDF-...-24)
Certification	Germanischer Lloyd (all types except LDF-...-24)

1) Corrosion resistance class 1 to Festo standard 940 070
Components requiring low corrosion resistance. Transport and storage protection. Parts that do not have primarily decorative surface requirements, e.g. in internal areas that are not visible or behind covers.

Weights [g]							
Variant	H1	H2	H3	H4	H5	H6	H7
Adsorption dryer	5,400	6,500	9,200	24,700	30,200	35,700	41,200

Adsorption dryer LDF

Technical data



- - Note

Please do not use the average consumption values as your guide when setting up the dryer, instead use

- a) the inlet pressure of the dryer
- b) the peak value for the flow rate
- c) the maximum permissible inlet temperature.

The adsorption dryers are designed for continuous operation. Pulsed or intermittent operation can lead to the premature aging of and/or damage to the drying agent and thus to the failure of the dryer.

If the adsorption dryer LDF is nonetheless to be used in pulsed or intermittent mode the use of buffer reservoirs, through which the compressed air flows, is recommended. Depending on the application these can be mounted before and/or after the dryer.

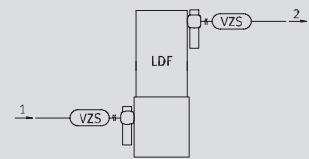

The pressure reservoirs may not be connected on one side only:

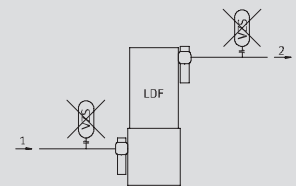

Standard nominal flow rate q_{nN} [Nl/min] at pressure dew point -40 °C

Type	Temperature of medium	Input pressure [bar]					
		4	5	6	7	8	10
LDF-H1	20 °C	25.9	40.1	57.4	65.6	73.8	90.1
	35 °C	25.2	39.1	57.8	66.1	74.3	90.8
LDF-H2	20 °C	51.7	80.2	114.8	131.2	147.6	180.3
	35 °C	50.4	78.2	115.7	132.1	148.6	181.6
LDF-H3	20 °C	111.9	173.6	248.8	284.3	319.8	390.7
	35 °C	109.1	169.3	250.6	286.4	322.1	393.6
LDF-H4	20 °C	207.8	322.3	461.5	527.2	593.0	724.6
	35 °C	202.7	314.4	464.8	531.1	597.4	729.9
LDF-H5	20 °C	273.8	424.8	607.7	694.3	781.0	954.2
	35 °C	267.1	414.3	612.1	699.4	786.7	961.2
LDF-H6	20 °C	359.7	558.0	799.2	913.1	1,027.1	1,255.0
	35 °C	350.9	544.3	805.0	919.8	1,034.6	1,264.1
LDF-H7	20 °C	456.1	707.5	1,013.0	1,157.4	1,301.9	1,590.7
	35 °C	444.9	690.1	1,020.4	1,165.9	1,311.3	1,602.3

Adsorption dryer LDF

Technical data

FESTO

Dimensions

Download CAD data → www.festo.com/en/engineering

LDF-H1 ... H3

LDF-H4 ... H7

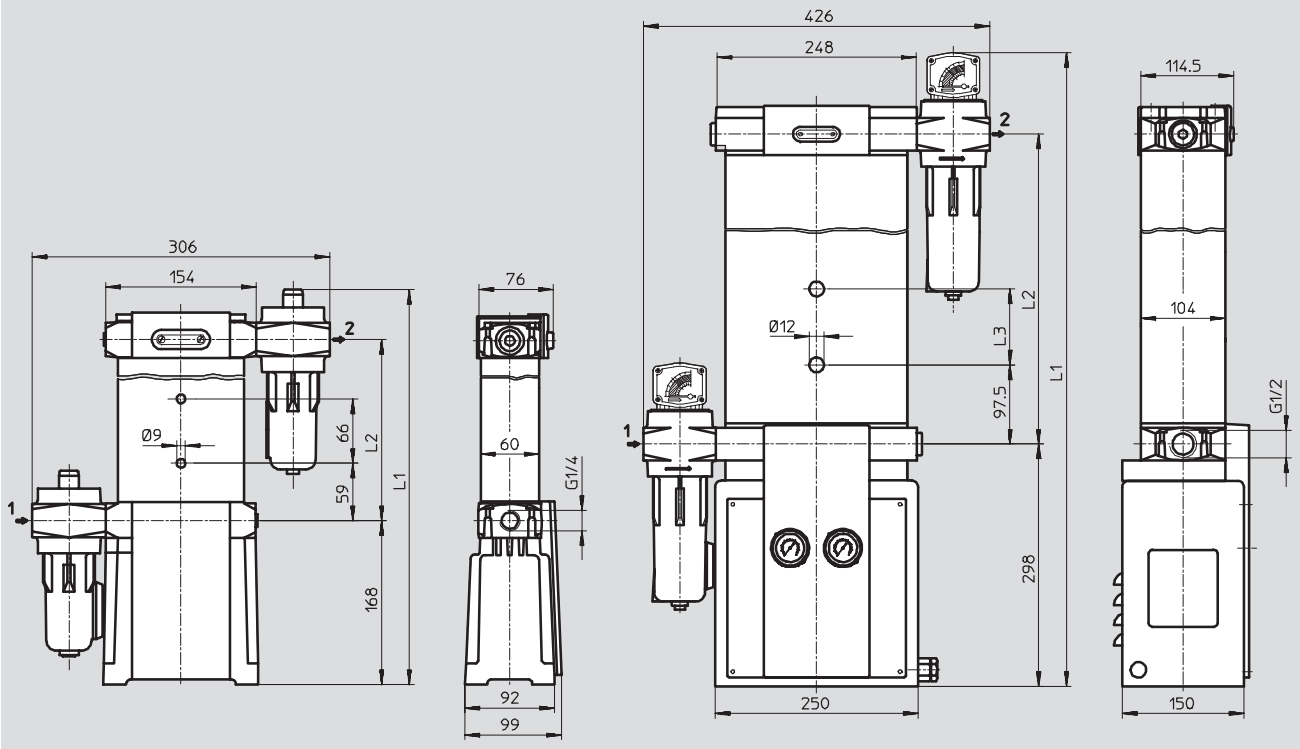

Type	L1	L2	L3
H1	403	186	-
H2	498	281	-
H3	738	521	-
H4	780	382	93.5
H5	946	548	176.5
H6	1,111	713	259
H7	1,176	778	341.5

Ordering data

Type	Connection	24 V DC		110 V AC		230 V AC	
		Part No.	Type	Part No.	Type	Part No.	Type
H1	G $\frac{1}{4}$	178 516	LDF-H1-G $\frac{1}{4}$ -24 ¹⁾	178 517	LDF-H1-G $\frac{1}{4}$ -110 ¹⁾	178 518	LDF-H1-G $\frac{1}{4}$ -230 ¹⁾
H2		178 519	LDF-H2-G $\frac{1}{4}$ -24 ¹⁾	178 520	LDF-H2-G $\frac{1}{4}$ -110 ¹⁾	178 521	LDF-H2-G $\frac{1}{4}$ -230 ¹⁾
H3		178 522	LDF-H3-G $\frac{1}{4}$ -24 ¹⁾	178 523	LDF-H3-G $\frac{1}{4}$ -110 ¹⁾	178 524	LDF-H3-G $\frac{1}{4}$ -230 ¹⁾
H4	G $\frac{1}{2}$	178 525	LDF-H4-G $\frac{1}{2}$				
H5		178 528	LDF-H5-G $\frac{1}{2}$				
H6		178 531	LDF-H6-G $\frac{1}{2}$				
H7		178 534	LDF-H7-G $\frac{1}{2}$				

1) Free of copper and PTFE

Adsorption dryer LDF

Accessories

FESTO

Drying agent LDF-TM

Drying agent:
Aluminium oxide

Ordering data									
Weight [g]	Dryer type (volume required)							Part No.	Type
	H1	H2	H3	H4	H5	H6	H7		
1,000	1	1	2	-	2	-	2	538 661	LDF-TM-H1-H7-1KG
4,000	-	-	-	1	1	2	2	538 662	LDF-TM-H1-H7-4KG

Funnel LDF-FS

Ordering data		
Type	Part No.	Type
H1 ... H3	538 668	LDF-FS-H1-H3
H4 ... H7	538 669	LDF-FS-H4-H7

Seal range LDF-DS

Ordering data		
Type	Part No.	Type
H1 ... H3	538 670	LDF-DS-H1-H3
H4 ... H7	538 671	LDF-DS-H4-H7

Filter cartridge LFMBP/LFMAP

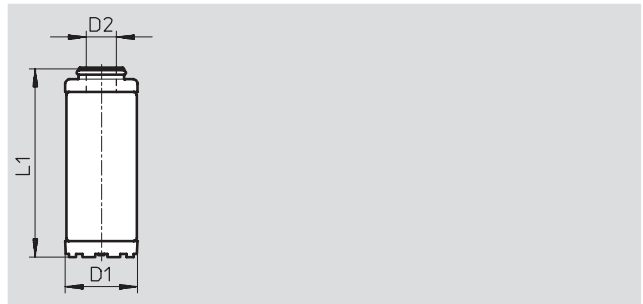

Ordering data							
Dryer type	Connection	Grade of filtration [µm]	D1 ∅	D2 ∅	L1	Part No.	Type
For inlet filter							
H1 ... H3	G1/4	0.01	35	6.75	74	185 688	LFMAP-1/4-H
H4 ... H7	G1/2	0.01	48	21.7	126	162 824	LFMAP-1/2-H
For outlet filter							
H1 ... H3	G1/4	1	35	6.75	74	185 689	LFMBP-1/4-H
H4 ... H7	G1/2	1	48	21.7	126	162 827	LFMBP-1/2-H