



- Compact cylinders with multifunctional mounting options
- Small, light and reliable
- Ideal for direct mounting

Compact cylinders DMM/EMM, Multimount



Product range overview

Function	Version	Type	Piston \varnothing [mm]	Stroke [mm]	Position sensing
Double-acting	Basic version				
		DMM Piston rod at one end	10	5, 10, 15, 20, 25, 30	■
			16	5, 10, 15, 20, 25, 30, 40	
			20, 25, 32	5, 10, 15, 20, 25, 30, 40, 50	
		DMM-...-S2 Through piston rod	10	5, 10, 15, 20, 25, 30	■
			16	5, 10, 15, 20, 25, 30, 40	
			20, 25, 32	5, 10, 15, 20, 25, 30, 40, 50	
	Non-rotating version				
		DMML Piston rod at one end	10	5, 10, 15, 20, 25, 30	■
			16	5, 10, 15, 20, 25, 30, 40	
20, 25, 32			5, 10, 15, 20, 25, 30, 40, 50		
	DMML-...-S2 Through piston rod	10	5, 10, 15, 20, 25, 30	■	
		16	5, 10, 15, 20, 25, 30, 40		
		20, 25, 32	5, 10, 15, 20, 25, 30, 40, 50		
Single-acting	Basic version				
		EMM Piston rod at one end, pushing	10, 16, 20, 25, 32	5, 10, 15	■
		EMMZ Piston rod at one end, pulling	10, 16, 20, 25, 32	5, 10, 15	■
	Non-rotating version				
		EMML Piston rod at one end, pushing	10, 16, 20, 25, 32	5, 10, 15	■
		EMMLZ Piston rod at one end, pulling	10, 16, 20, 25, 32	5, 10, 15	■

Cylinders with piston rods
Screw-in/screw-on cylinders

2.5

Compact cylinders DMM/EMM, Multimount

Product range overview

FESTO

Type	Piston rod with male thread	S20 Hollow piston rod	S6 Heat resistant up to 120 °C	→ Page
Basic version				
DMM Piston rod at one end	■	-	■	1 / 2.5-13
DMM-...-S2 Through piston rod	■	■ ∅ 16 ... 32	-	1 / 2.5-13
Non-rotating version				
DMML Piston rod at one end	■	-	■	1 / 2.5-13
DMML-...-S2 Through piston rod	■	■ ∅ 16 ... 32	-	1 / 2.5-13
Basic version				
EMM Piston rod at one end, pushing	■	-	■	1 / 2.5-19
EMMZ Piston rod at one end, pulling	■	-	■	1 / 2.5-19
Non-rotating version				
EMML Piston rod at one end, pushing	■	-	■	1 / 2.5-19
EMMLZ Piston rod at one end, pulling	■	-	■	1 / 2.5-19

Cylinders with piston rods
Screw-in/screw-on cylinders

2.5

Compact cylinders DMM/EMM, Multimount

Peripherals overview

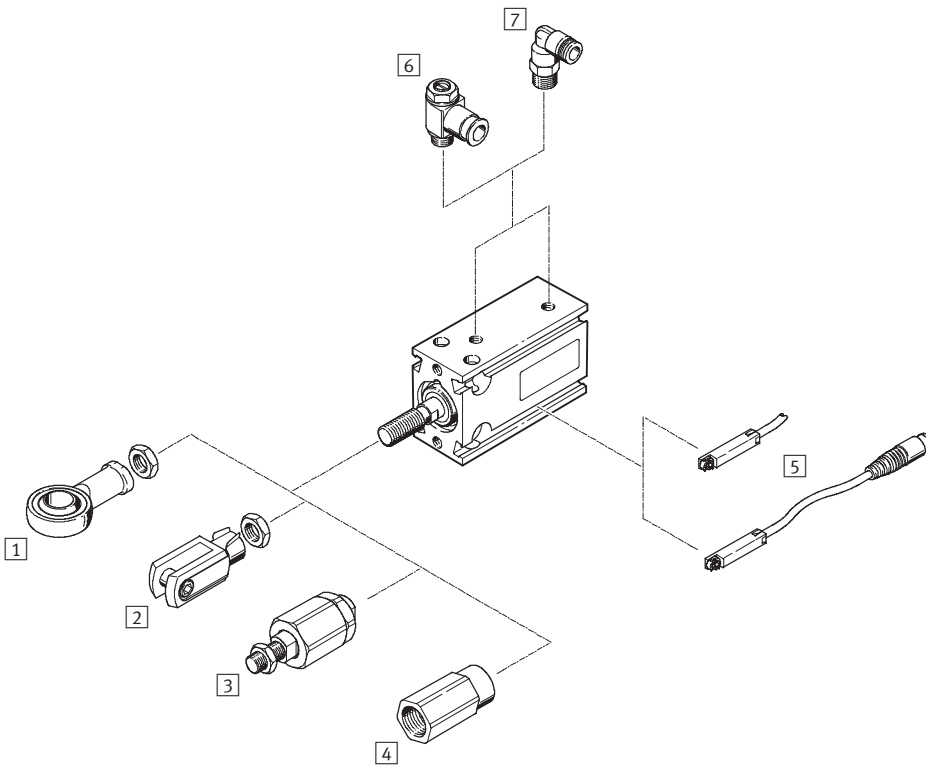

Variants

DMM	DMML	EMM	EMML
DMM-...-S2, DMM-...-S20	DMML-...-S2, DMML-...-S20	EMMZ	EMMLZ

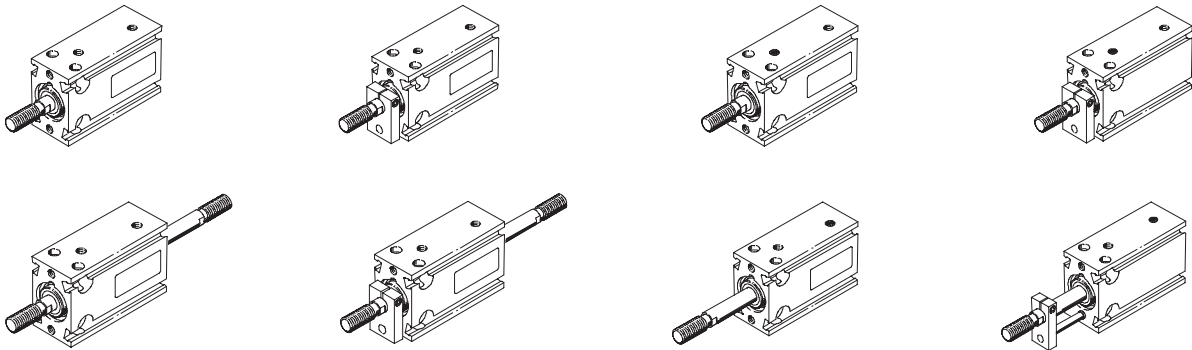

Cylinders with piston rods
Screw-in/screw-on cylinders

2.5

Compact cylinders DMM/EMM, Multimount

Peripherals overview

Accessories						
	Brief description	DMM DMM-...-S2 DMM-...-S20	DMML DMML-...-S2 DMML-...-S20	EMM EMMZ	EMML EMMLZ	→ Page
1	Rod eye SGS	■	■	■	■	1 / 2.5-24
2	Rod clevis SG	■	■	■	■	1 / 2.5-24
3	Self-aligning rod coupler FK	■	■	■	■	1 / 2.5-24
4	Adapter AD	■ S20	■ S20	-	-	1 / 2.5-24
5	Proximity sensor SME/SMT-8	■	■	■	■	1 / 2.5-24
6	One-way flow control valve GRLA/GRLZ	■	■	■	■	1 / 2.5-25
7	Push-in connector QS	■	■	■	■	Volume 3

Mounting options

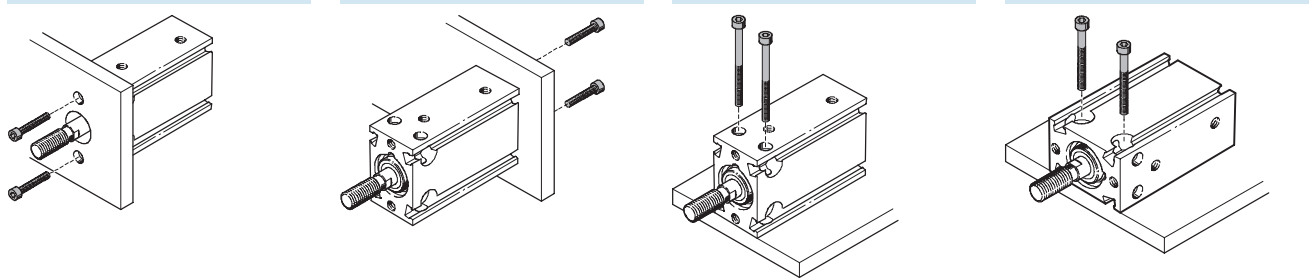

Cylinders with piston rods
Screw-in/screw-on cylinders

Compact cylinders DMM/EMM, Multimount

Type code



Cylinders with piston rods
Screw-in/screw-on cylinders

2.5

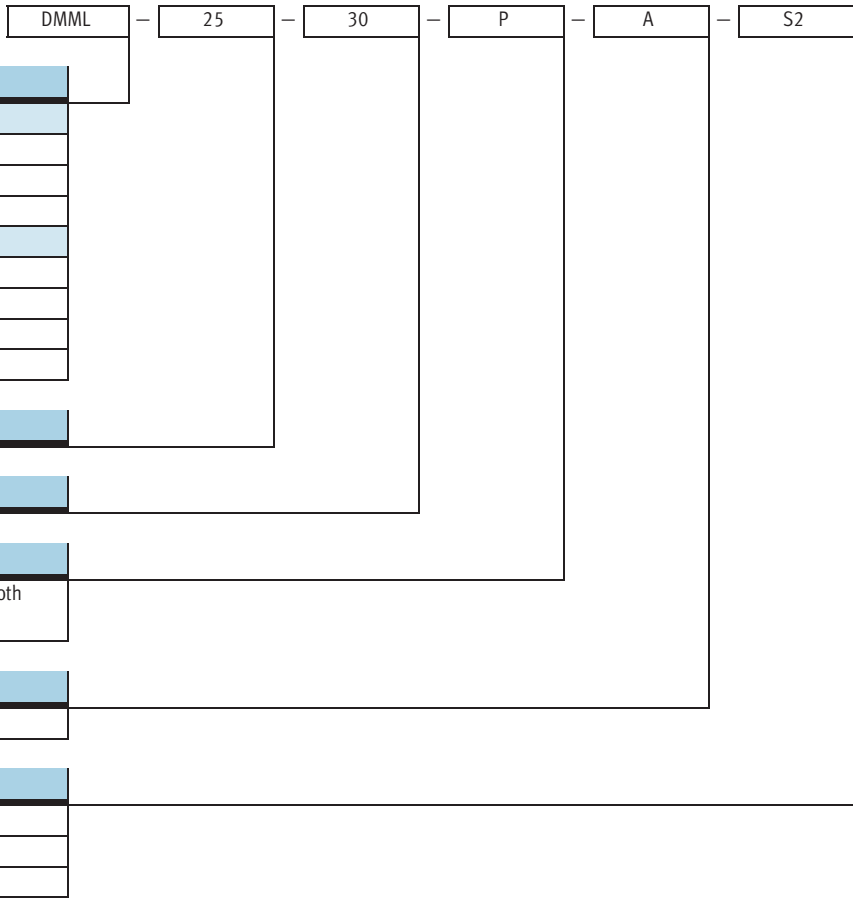

Compact cylinders DMM, Multimount

Technical data

FESTO

Function

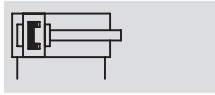

- - Diameter
10 ... 32 mm

- - Stroke length
5 ... 50 mm

- - [www.festo.com/en/
Spare_parts_service](http://www.festo.com/en/Spare_parts_service)

Variants



S2



S6



S20

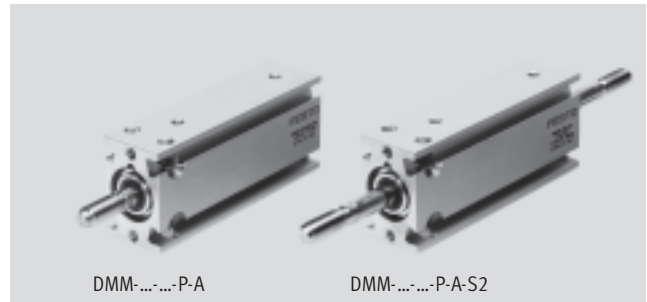

DMM-...-P-A

DMM-...-P-A-S2

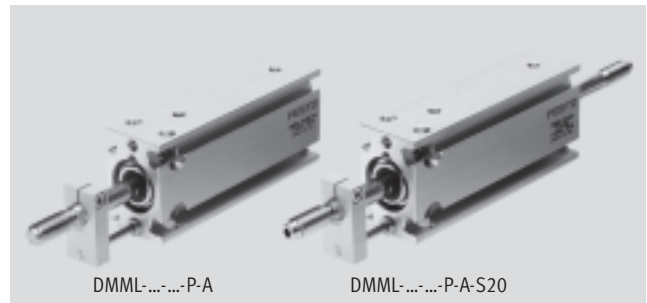

DMML-...-P-A

DMML-...-P-A-S20

General technical data						
Piston \varnothing	10	16	20	25	32	
Pneumatic connection	M3	M5	M5	M5	G $\frac{1}{8}$	
End of piston rod	Male thread	M4	M6	M8	M10x1.25	M10x1.25
Operating medium	Compressed air, filtered, lubricated or unlubricated					
Max. operating pressure	[bar]	10				
Constructional design	Piston					
	Piston rod					
Cushioning	Flexible cushioning rings/plates at both ends					
Position sensing	For proximity sensing					
Type of mounting	Via through holes					
	Via female thread					
Mounting position	Any					

Ambient conditions		
Variant	Basic version	S6
Ambient temperature ¹⁾	[°C]	-20 ... +80
		0 ... +120

1) Note operating range of proximity sensors

Compact cylinders DMM, Multimount

Technical data



Forces [N] and impact energy [J]					
Piston Ø	10	16	20	25	32
Theoretical force at 6 bar, advancing	47	121	188	295	483
	S2/S20 40	104	158	247	415
Theoretical force at 6 bar, retracting	40	104	158	247	415
	S2/S20 40	104	158	247	415
Max. impact energy at end positions	0.1	0.2	0.3	0.6	0.6

Technical data – Protection against rotation					
Piston Ø	10	16	20	25	32
Max. torque at the piston rod ¹⁾ [Nm]	0.02	0.01	0.01	0.015	0.02

1) The max. torque must not be exceeded even when fitting attachments.

Materials

Sectional view

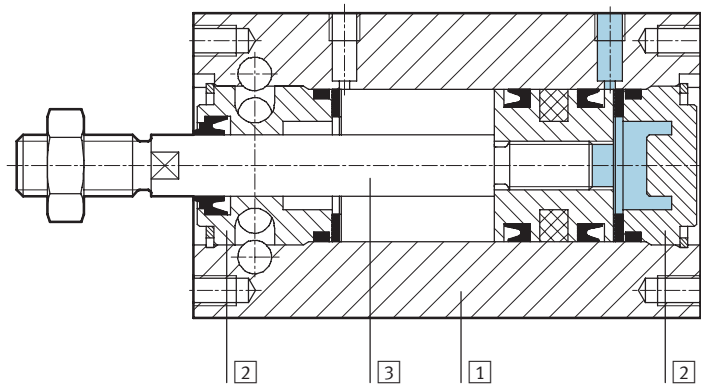

Compact cylinder	Basic version	S6
1 Housing	Wrought aluminium alloy	Wrought aluminium alloy
2 Plug cap	Brass	Brass
3 Piston rod	High-alloy stainless steel	High-alloy stainless steel
– Seals	Polyurethane	Fluorocarbon rubber

Compact cylinders DMM, Multimount

Technical data



Dimensions – Basic cylinder

Download CAD data → www.festo.com/en/engineering

Basic version DMM

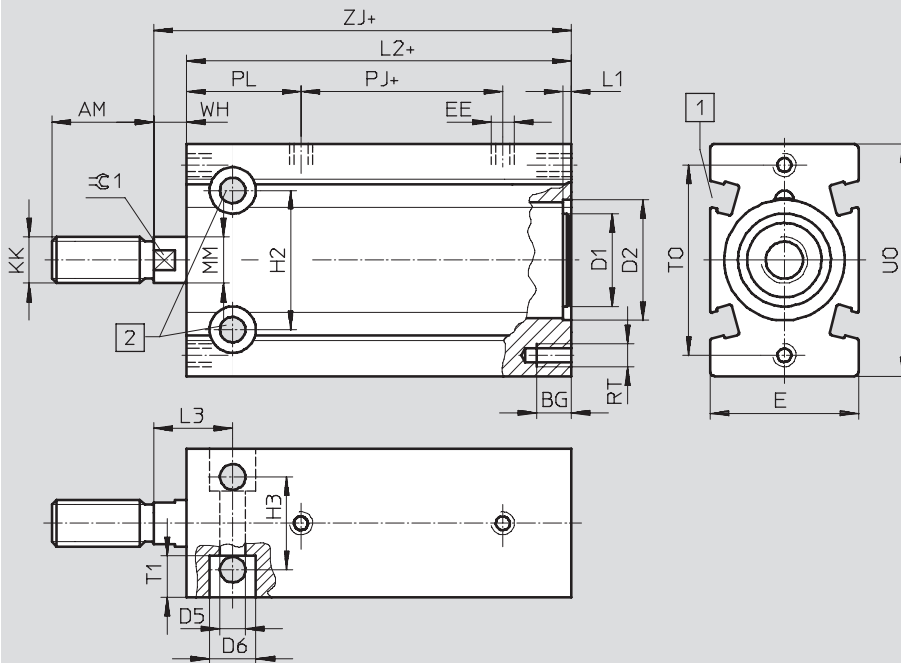

- 1 Sensor slot for proximity sensor SME/SMT-8
- 2 Max. tightening torque
- + = plus stroke length

Non-rotating version DMML

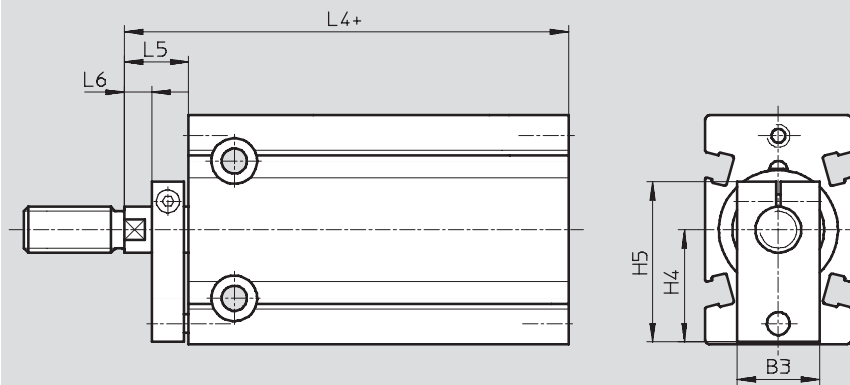

- + = plus stroke length

∅	AM	B3	BG	D1	D2	D5	D6	E	EE	H2	H3	H4	H5	KK	L1	L2
[mm]			+0.5	∅	∅ H7	∅ +0.2	∅ +0.3									
10	12	14	5	–	10.8	3.4	6	15	M3	13	9	11	19.5	M4	0.9	48
16	16	15	6	12.9	17	4.3	7.5	20	M5	19	13	15.5	24	M6	0.9	52
20	20	15	7.5	16	21	5.5	10	26	M5	24	16	19.5	29	M8	1.9	55
25	22	18	7.5	20	26	5.5	10	32	M5	30	20	24.5	36	M10x1.25	1.9	58
32	22	20	9	26	33	6.6	11	40	G ¹ / ₈	40	24	30.5	45	M10x1.25	1.9	62

∅	L3	L4	L5	L6	MM	PJ	PL	RT	T1	U0	T0	WH	ZJ	∅C1	Max. tightening torque
[mm]					∅									h13	[Nm] +10%
10	11	57	9	–	4	12	24	M3	5	25	19	2	50	–	1
16	13.5	64	12	3	6	16.5	22	M4	5.5	32	27	5	57	5	2.5
20	16	68	13	4	8	16.8	25.7	M5	8	40	33	6	61	7	3
25	17	72	14	5	10	18.5	24.7	M5	9	50	41	7	65	9	8
32	19	77	15	6	12	19	26	M6	11.5	62	52	8	70	10	9

Compact cylinders DMM, Multimount

Technical data



Dimensions – Variants

Download CAD data → www.festo.com/en/engineering

S2 – Through piston rod

Basic version DMM

Non-rotating version DMML

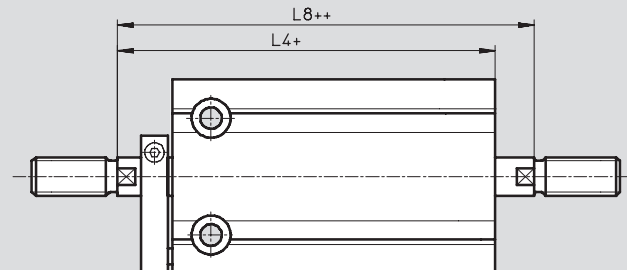
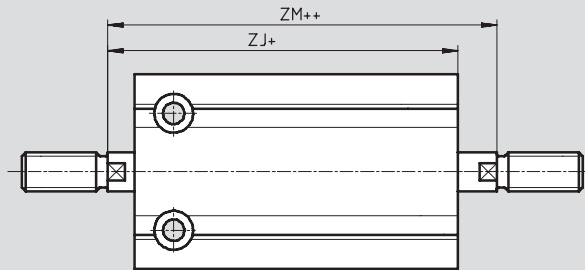

- + = plus stroke length
- ++ = plus 2x stroke length

S20 – Through, hollow piston rod

Basic version DMM

Non-rotating version DMML

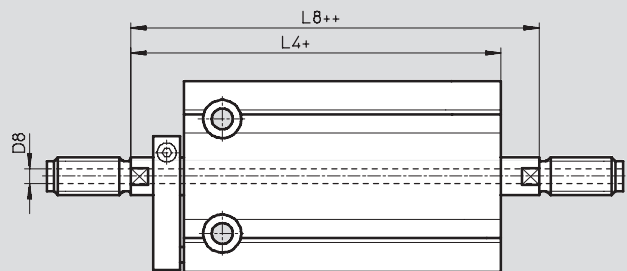
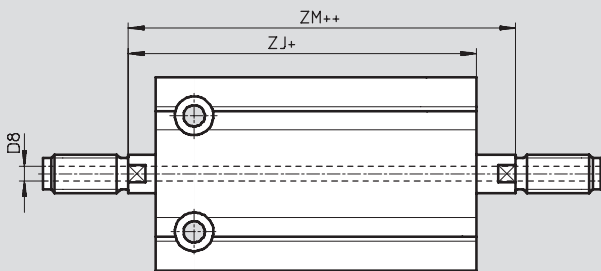

- + = plus stroke length
- ++ = plus 2x stroke length

∅	D8	L4	L8	ZJ	ZM
[mm]	∅				
10	-	57	59	50	52
16	2.3	64	69	57	62
20	3.2	68	74	61	67
25	3.8	72	79	65	72
32	4.5	77	85	70	78

Compact cylinders DMM, Multimount

Technical data





Ordering data – Basic cylinder						
Type	Piston Ø [mm]	Stroke ¹⁾ [mm]	Basic version DMM		Non-rotating version DMML	
			Part No.	Type	Part No.	Type
	10	5	158 502	DMM-10-5-P-A	158 557	DMML-10-5-P-A
		10	158 503	DMM-10-10-P-A	158 558	DMML-10-10-P-A
		15	158 504	DMM-10-15-P-A	158 559	DMML-10-15-P-A
		20	158 505	DMM-10-20-P-A	158 560	DMML-10-20-P-A
		25	158 506	DMM-10-25-P-A	158 561	DMML-10-25-P-A
		30	158 507	DMM-10-30-P-A	158 562	DMML-10-30-P-A
		16	5	158 511	DMM-16-5-P-A	158 566
	10		158 512	DMM-16-10-P-A	158 567	DMML-16-10-P-A
	15		158 513	DMM-16-15-P-A	158 568	DMML-16-15-P-A
	20		158 514	DMM-16-20-P-A	158 569	DMML-16-20-P-A
	25		158 515	DMM-16-25-P-A	158 570	DMML-16-25-P-A
	30		158 516	DMM-16-30-P-A	158 571	DMML-16-30-P-A
	40		178 210	DMM-16-40-P-A	178 328	DMML-16-40-P-A
	20	5	158 521	DMM-20-5-P-A	158 576	DMML-20-5-P-A
		10	158 522	DMM-20-10-P-A	158 577	DMML-20-10-P-A
		15	158 523	DMM-20-15-P-A	158 578	DMML-20-15-P-A
		20	158 524	DMM-20-20-P-A	158 579	DMML-20-20-P-A
		25	158 525	DMM-20-25-P-A	158 580	DMML-20-25-P-A
		30	158 526	DMM-20-30-P-A	158 581	DMML-20-30-P-A
		40	158 527	DMM-20-40-P-A	158 582	DMML-20-40-P-A
		50	158 528	DMM-20-50-P-A	158 583	DMML-20-50-P-A
	25	5	158 533	DMM-25-5-P-A ²⁾	158 588	DMML-25-5-P-A ²⁾
		10	158 534	DMM-25-10-P-A ²⁾	158 589	DMML-25-10-P-A ²⁾
		15	158 535	DMM-25-15-P-A ²⁾	158 590	DMML-25-15-P-A ²⁾
		20	158 536	DMM-25-20-P-A ²⁾	158 591	DMML-25-20-P-A ²⁾
		25	158 537	DMM-25-25-P-A ²⁾	158 592	DMML-25-25-P-A ²⁾
		30	158 538	DMM-25-30-P-A ²⁾	158 593	DMML-25-30-P-A ²⁾
		40	158 539	DMM-25-40-P-A ²⁾	158 594	DMML-25-40-P-A ²⁾
50		158 540	DMM-25-50-P-A ²⁾	158 595	DMML-25-50-P-A ²⁾	
32	5	158 545	DMM-32-5-P-A ²⁾	158 600	DMML-32-5-P-A ²⁾	
	10	158 546	DMM-32-10-P-A ²⁾	158 601	DMML-32-10-P-A ²⁾	
	15	158 547	DMM-32-15-P-A ²⁾	158 602	DMML-32-15-P-A ²⁾	
	20	158 548	DMM-32-20-P-A ²⁾	158 603	DMML-32-20-P-A ²⁾	
	25	158 549	DMM-32-25-P-A ²⁾	158 604	DMML-32-25-P-A ²⁾	
	30	158 550	DMM-32-30-P-A ²⁾	158 605	DMML-32-30-P-A ²⁾	
	40	158 551	DMM-32-40-P-A ²⁾	158 606	DMML-32-40-P-A ²⁾	
	50	158 552	DMM-32-50-P-A ²⁾	158 607	DMML-32-50-P-A ²⁾	

- 1) Additional stroke lengths upon request
- 2) The scope of delivery includes a hexagonal nut for the piston rod thread

Compact cylinders DMM, Multimount

Technical data

FESTO

Ordering data – Variants						
Type	Piston Ø [mm]	Stroke ¹⁾ [mm]	Basic version DMM		Non-rotating version DMML	
			Part No.	Type	Part No.	Type
S2 – Through piston rod						
	10	5, 10, 20, 25, 30	158 508	DMM-10-...-P-A-S2	158 563	DMML-10-...-P-A-S2
	16	5, 10, 15, 20, 25, 30, 40	158 517	DMM-16-...-P-A-S2	158 572	DMML-16-...-P-A-S2
	20	5, 10, 15, 20, 25, 30, 40, 50	158 529	DMM-20-...-P-A-S2	158 584	DMML-20-...-P-A-S2
	25	5, 10, 15, 20, 25, 30, 40, 50	158 541	DMM-25-...-P-A-S2²⁾	158 596	DMML-25-...-P-A-S2²⁾
	32	5, 10, 15, 20, 25, 30, 40, 50	158 553	DMM-32-...-P-A-S2²⁾	158 608	DMML-32-...-P-A-S2²⁾
<hr/>						
	10	5, 10, 15, 20, 25, 30	158 509	DMM-10-...-P-A-S6	158 564	DMML-10-...-P-A-S6
	16	5, 10, 15, 20, 25, 30, 40	158 518	DMM-16-...-P-A-S6	158 573	DMML-16-...-P-A-S6
	20	5, 10, 15, 20, 25, 30, 40, 50	158 530	DMM-20-...-P-A-S6	158 585	DMML-20-...-P-A-S6
	25	5, 10, 15, 20, 25, 30, 40, 50	158 542	DMM-25-...-P-A-S6²⁾	158 597	DMML-25-...-P-A-S6²⁾
	32	5, 10, 15, 20, 25, 30, 40, 50	158 554	DMM-32-...-P-A-S6²⁾	158 609	DMML-32-...-P-A-S6²⁾
<hr/>						
	16	5, 10, 15, 20, 25, 30, 40	158 519	DMM-16-...-P-A-S20	158 574	DMML-16-...-P-A-S20
	20	5, 10, 15, 20, 25, 30, 40, 50	158 531	DMM-20-...-P-A-S20	158 586	DMML-20-...-P-A-S20
	25	5, 10, 15, 20, 25, 30, 40, 50	158 543	DMM-25-...-P-A-S20²⁾	158 598	DMML-25-...-P-A-S20²⁾
	32	5, 10, 15, 20, 25, 30, 40, 50	158 555	DMM-32-...-P-A-S20²⁾	158 610	DMML-32-...-P-A-S20²⁾

1) Additional stroke lengths upon request

2) The scope of delivery includes a hexagonal nut for the piston rod thread

Compact cylinders EMM, Multimount

Technical data

Function

EMM, EMML



EMMZ, EMMLZ

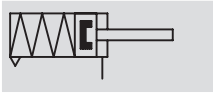

Variants



S6

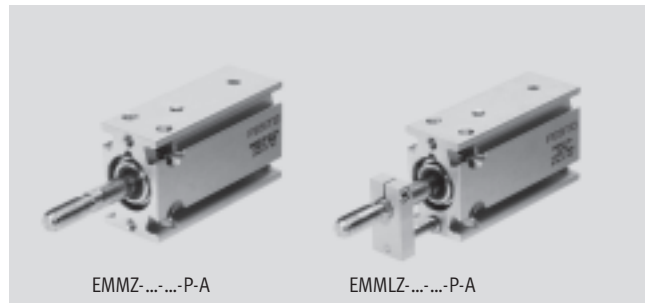
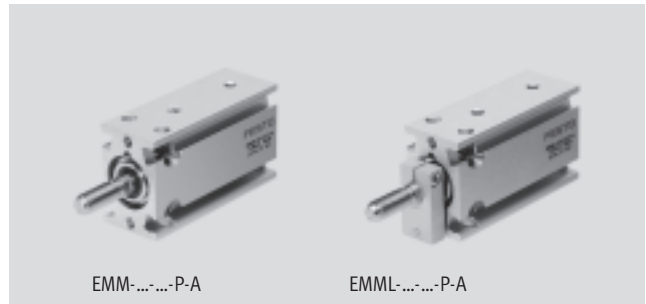

- - Diameter
10 ... 32 mm
- - Stroke length
5 ... 15 mm
- - www.festo.com/en/Spare_parts_service

General technical data						
Piston \varnothing	10	16	20	25	32	
Pneumatic connection	M3	M5	M5	M5	G $\frac{1}{8}$	
End of piston rod Male thread	M4	M6	M8	M10x1.25	M10x1.25	
Operating medium	Compressed air, filtered, lubricated or unlubricated					
Max. operating pressure [bar]	10					
Max. applied load ¹⁾ [g]	40	120	160	260	320	
Constructional design	Piston					
	Piston rod					
Cushioning	Flexible cushioning rings/plates at both ends					
Position sensing	For proximity sensing					
Type of mounting	Via through holes					
	Via female thread					
Mounting position	Any					

1) At 6 bar. For other values see graph "Maximum permissible impact velocity v as a function of the applied load m" → 1 / 2.5-20

Ambient conditions		
Variant	Basic version	S6
Ambient temperature ¹⁾ [°C]	-20 ... +80	0 ... +120

1) Note operating range of proximity sensors

Cylinders with piston rods
Screw-in/screw-on cylinders
2.5

Compact cylinders EMM, Multimount

Technical data



Forces [N] and impact energy [J]						
Piston Ø		10	16	20	25	32
Theoretical force at 6 bar, advancing	EMM/EMML	37	101	165	227	456
	EMMZ/EMMLZ	30	84	135	179	388
Max. impact energy at end positions		0.1	0.2	0.3	0.6	0.6

Maximum permissible impact velocity v as a function of the applied load m Minimum spring return force F as a function of the stroke l

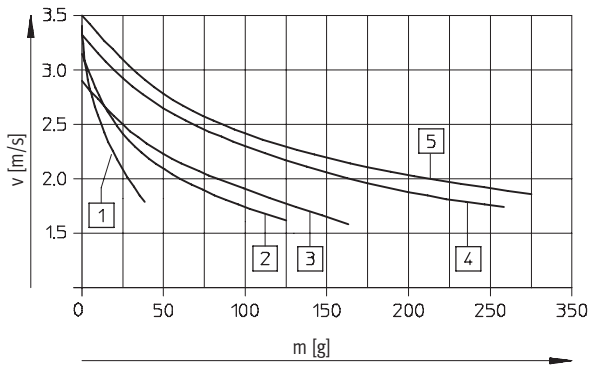

- 1 Ø 10 mm
- 2 Ø 16 mm
- 3 Ø 20 mm
- 4 Ø 25 mm

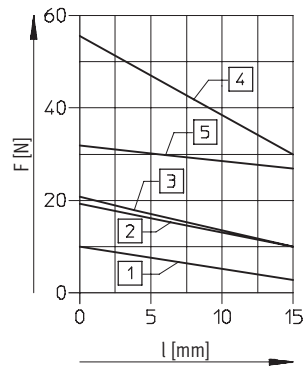

- 5 Ø 32 mm

Technical data – Protection against rotation						
Piston Ø		10	16	20	25	32
Max. torque at the piston rod ¹⁾	[Nm]	0.02	0.01	0.01	0.015	0.02

1) The max. torque must not be exceeded even when fitting attachments

Cylinders with piston rods
Screw-in/screw-on cylinders

2.5

Materials

Sectional view EMM(L) – Pushing

Sectional view EMM(L)Z – Pulling

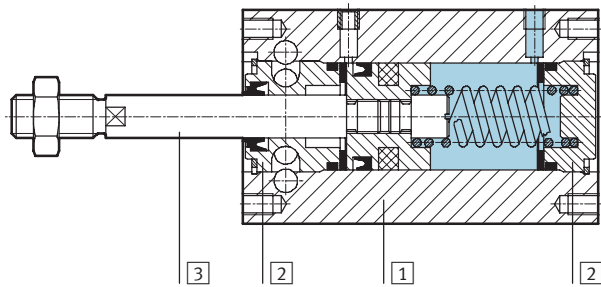
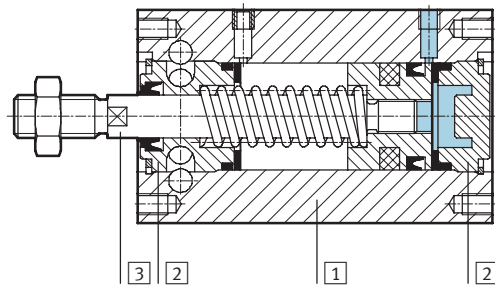

Compact cylinder	Basic version	S6
1 Housing	Wrought aluminium alloy	Wrought aluminium alloy
2 Plug cap	Brass	Brass
3 Piston rod	High-alloy stainless steel	High-alloy stainless steel
– Seals	Polyurethane	Fluorocarbon rubber

Compact cylinders EMM, Multimount

Technical data



Dimensions Download CAD data → www.festo.com/en/engineering

Basic version EMM – Pushing

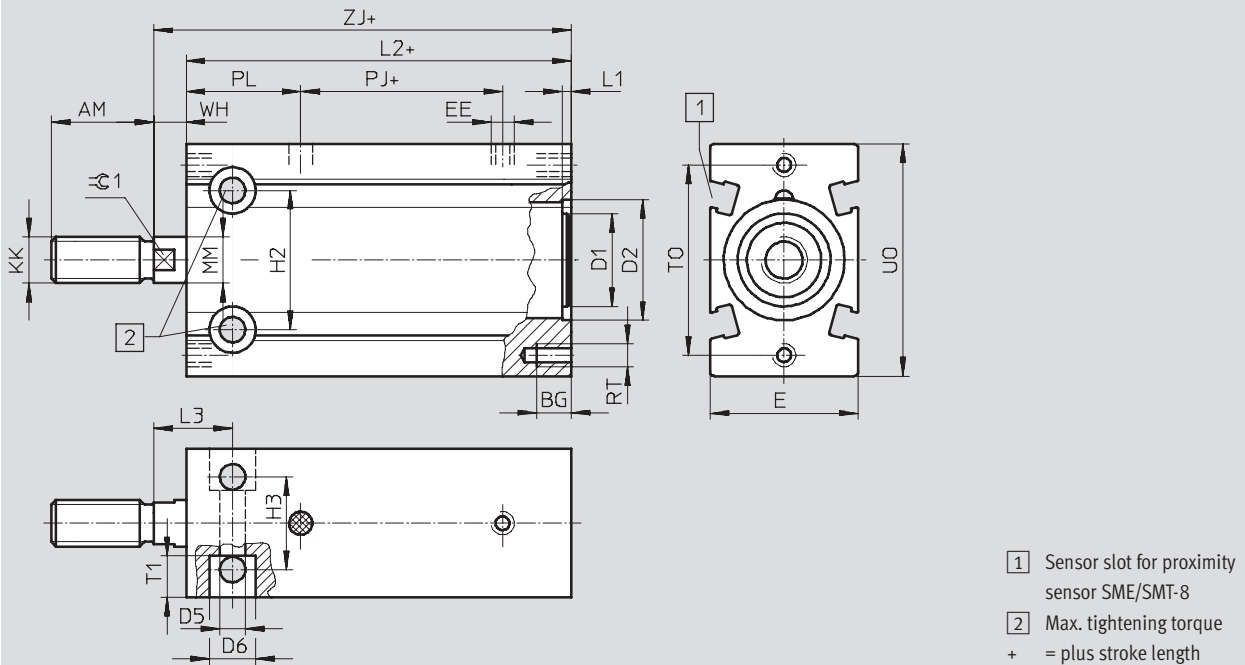

Non-rotating version EMLL – Pushing

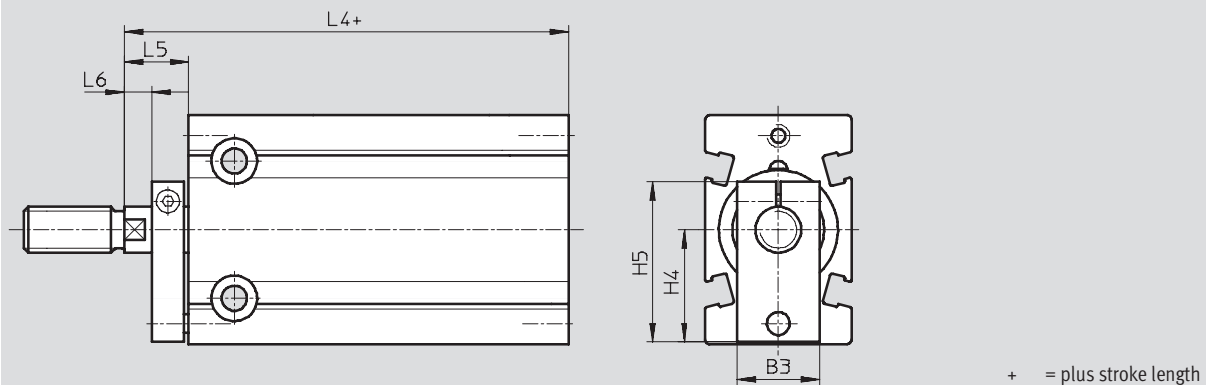

∅	AM	B3	BG	D1	D2	D5	D6	E	EE	H2	H3	H4	H5	KK	L1	L2
[mm]			+0.5	∅	∅ H7	+0.2	+0.3									
10	12	14	5	–	10.8	3.4	6	15	M3	13	9	11	19.5	M4	0.9	48
16	16	15	6	12.9	17	4.3	7.5	20	M5	19	13	15.5	24	M6	0.9	52
20	20	15	7.5	16	21	5.5	10	26	M5	24	16	19.5	29	M8	1.9	55
25	22	18	7.5	20	26	5.5	10	32	M5	30	20	24.5	36	M10x1.25	1.9	58
32	22	20	9	26	33	6.6	11	40	G ¹ / ₈	40	24	30.5	45	M10x1.25	1.9	62

∅	L3	L4	L5	L6	MM	PJ	PL	RT	T1	U0	T0	WH	ZJ	∅C1	Max. tightening torque
[mm]					∅									h13	[Nm] +10%
10	11	57	9	–	4	12	24	M3	5	25	19	2	50	–	1
16	13.5	64	12	3	6	16.5	22	M4	5.5	32	27	5	57	5	2.5
20	16	68	13	4	8	16.8	25.7	M5	8	40	33	6	61	7	3
25	17	72	14	5	10	18.5	24.7	M5	9	50	41	7	65	9	8
32	19	77	15	6	12	19	26	M6	11.5	62	52	8	70	10	9

Compact cylinders EMM, Multimount

Technical data

FESTO

Dimensions Download CAD data → www.festo.com/en/engineering

Basic version EMMZ – Pulling

Non-rotating version EMMLZ – Pulling

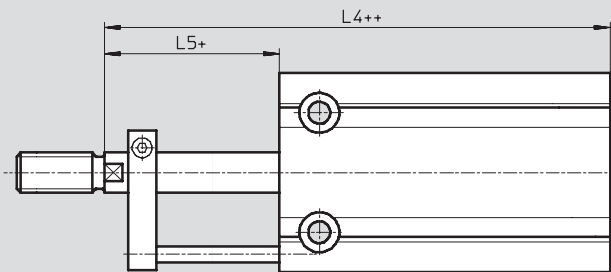
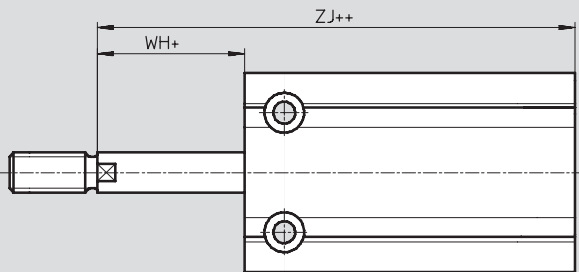

+ = plus stroke length
++ = plus 2x stroke length

∅	L4	L5	WH	ZJ
[mm]				
10	57	9	2	50
16	64	12	5	57
20	68	13	6	61
25	72	14	7	65
32	77	15	8	70

Ordering data – Basic cylinder, pushing

Type	Piston ∅ [mm]	Stroke ¹⁾ [mm]	Basic version EMM		Non-rotating version EMML	
			Part No.	Type	Part No.	Type
	10	5	158 612	EMM-10-5-P-A	158 637	EMML-10-5-P-A
		10	158 613	EMM-10-10-P-A	158 638	EMML-10-10-P-A
		15	158 614	EMM-10-15-P-A	158 639	EMML-10-15-P-A
	16	5	158 617	EMM-16-5-P-A	158 642	EMML-16-5-P-A
		10	158 618	EMM-16-10-P-A	158 643	EMML-16-10-P-A
		15	158 619	EMM-16-15-P-A	158 644	EMML-16-15-P-A
	20	5	158 622	EMM-20-5-P-A	158 647	EMML-20-5-P-A
		10	158 623	EMM-20-10-P-A	158 648	EMML-20-10-P-A
		15	158 624	EMM-20-15-P-A	158 649	EMML-20-15-P-A
25	5	158 627	EMM-25-5-P-A ²⁾	158 652	EMML-25-5-P-A ²⁾	
	10	158 628	EMM-25-10-P-A ²⁾	158 653	EMML-25-10-P-A ²⁾	
	15	158 629	EMM-25-15-P-A ²⁾	158 654	EMML-25-15-P-A ²⁾	
32	5	158 632	EMM-32-5-P-A ²⁾	158 657	EMML-32-5-P-A ²⁾	
	10	158 633	EMM-32-10-P-A ²⁾	158 658	EMML-32-10-P-A ²⁾	
	15	158 634	EMM-32-15-P-A ²⁾	158 659	EMML-32-15-P-A ²⁾	

1) Additional stroke lengths upon request

2) The scope of delivery includes a hexagonal nut for the piston rod thread

Compact cylinders EMM, Multimount

Technical data

FESTO

Ordering data – Basic cylinder, pulling						
Type	Piston Ø [mm]	Stroke ¹⁾ [mm]	Basic version EMMZ		Non-rotating version EMMLZ	
			Part No.	Type	Part No.	Type
	10	5	158 662	EMMZ-10-5-P-A	158 687	EMMLZ-10-5-P-A
		10	158 663	EMMZ-10-10-P-A	158 688	EMMLZ-10-10-P-A
		15	158 664	EMMZ-10-15-P-A	158 689	EMMLZ-10-15-P-A
	16	5	158 667	EMMZ-16-5-P-A	158 692	EMMLZ-16-5-P-A
		10	158 668	EMMZ-16-10-P-A	158 693	EMMLZ-16-10-P-A
		15	158 669	EMMZ-16-15-P-A	158 694	EMMLZ-16-15-P-A
	20	5	158 672	EMMZ-20-5-P-A	158 697	EMMLZ-20-5-P-A
		10	158 673	EMMZ-20-10-P-A	158 698	EMMLZ-20-10-P-A
		15	158 674	EMMZ-20-15-P-A	158 699	EMMLZ-20-15-P-A
	25	5	158 677	EMMZ-25-5-P-A ²⁾	158 702	EMMLZ-25-5-P-A ²⁾
		10	158 678	EMMZ-25-10-P-A ²⁾	158 703	EMMLZ-25-10-P-A ²⁾
		15	158 679	EMMZ-25-15-P-A ²⁾	158 704	EMMLZ-25-15-P-A ²⁾
	32	5	158 682	EMMZ-32-5-P-A ²⁾	158 707	EMMLZ-32-5-P-A ²⁾
		10	158 683	EMMZ-32-10-P-A ²⁾	158 708	EMMLZ-32-10-P-A ²⁾
		15	158 684	EMMZ-32-15-P-A ²⁾	158 709	EMMLZ-32-15-P-A ²⁾

- 1) Additional stroke lengths upon request
- 2) The scope of delivery includes a hexagonal nut for the piston rod thread

Ordering data – Pushing variants						
Type	Piston Ø [mm]	Stroke ¹⁾ [mm]	Basic version EMM		Non-rotating version EMML	
			Part No.	Type	Part No.	Type
S6 – Heat resistant up to 120 °C						
	10	5, 10, 15	158 615	EMM-10-...-P-A-S6	158 640	EMML-10-...-P-A-S6
	16	5, 10, 15	158 620	EMM-16-...-P-A-S6	158 645	EMML-16-...-P-A-S6
	20	5, 10, 15	158 625	EMM-20-...-P-A-S6	158 650	EMML-20-...-P-A-S6
	25	5, 10, 15	158 630	EMM-25-...-P-A-S6 ²⁾	158 655	EMML-25-...-P-A-S6 ²⁾
	32	5, 10, 15	158 635	EMM-32-...-P-A-S6 ²⁾	158 660	EMML-32-...-P-A-S6 ²⁾

- 1) Additional stroke lengths upon request
- 2) The scope of delivery includes a hexagonal nut for the piston rod thread

Ordering data – Pulling variants						
Type	Piston Ø [mm]	Stroke ¹⁾ [mm]	Basic version EMMZ		Non-rotating version EMMLZ	
			Part No.	Type	Part No.	Type
S6 – Heat resistant up to 120 °C						
	10	5, 10, 15	158 665	EMMZ-10-...-P-A-S6	158 690	EMMLZ-10-...-P-A-S6
	16	5, 10, 15	158 670	EMMZ-16-...-P-A-S6	158 695	EMMLZ-16-...-P-A-S6
	20	5, 10, 15	158 675	EMMZ-20-...-P-A-S6	158 700	EMMLZ-20-...-P-A-S6
	25	5, 10, 15	158 680	EMMZ-25-...-P-A-S6 ²⁾	158 705	EMMLZ-25-...-P-A-S6 ²⁾
	32	5, 10, 15	158 685	EMMZ-32-...-P-A-S6 ²⁾	158 710	EMMLZ-32-...-P-A-S6 ²⁾

- 1) Additional stroke lengths upon request
- 2) The scope of delivery includes a hexagonal nut for the piston rod thread





Cylinders with piston rods
Screw-in/screw-on cylinders



2.5

Compact cylinders DMM/EMM, Multimount

Accessories

FESTO

Ordering data – Piston rod attachments				Technical data → 1 / 10.3-2			
Designation	For Ø	Part No.	Type	Designation	For Ø	Part No.	Type
Rod eye SGS				Self-aligning rod coupler FK			
	10	9 253	SGS-M4		10	6 528	FK-M4
	16	9 254	SGS-M6		16	2 061	FK-M6
	20	9 255	SGS-M8		20	2 062	FK-M8
	25	9 261	SGS-M10x1,25		25	6 140	FK-M10x1,25
	32				32		
Rod clevis SG				Adapter AD			
	10	6 532	SG-M4		16	157 328	AD-M6-M5
	16	3 110	SG-M6			157 329	AD-M6-1/8
	20	3 111	SG-M8			157 330	AD-M6-1/4
	25	6 144	SG-M10x1,25		20	157 331	AD-M8-1/8
	32				157 332	AD-M8-1/4	
				25	157 333	AD-M10x1,25-1/8	
				32	157 334	AD-M10x1,25-1/4	

Ordering data – Proximity switches for T-slot, magneto-resistive				Technical data → www.festo.com/catalogue/sm			
	Type of mounting	Switch output	Electrical connection	Cable length [m]	Part No.	Type	
N/O contact							
	Insertable in the slot from above, flush with cylinder profile	PNP	Cable, 3-wire	2,5	543 867	SMT-8M-PS-24V-K-2,5-OE	
			Plug M8x1, 3-pin	0,3	543 866	SMT-8M-PS-24V-K-0,3-M8D	
			Plug M12x1, 3-pin	0,3	543 869	SMT-8M-PS-24V-K-0,3-M12	
		NPN	Cable, 3-wire	2,5	543 870	SMT-8M-NS-24V-K-2,5-OE	
Plug M8x1, 3-pin	0,3		543 871	SMT-8M-NS-24V-K-0,3-M8D			
	Insertable in the slot lengthwise, flush with the cylinder profile	PNP	Cable, 3-wire	2,5	175 436	SMT-8-PS-K-LED-24-B	
			Plug M8x1, 3-pin	0,3	175 484	SMT-8-PS-S-LED-24-B	
N/C contact							
	Insertable in the slot from above, flush with cylinder profile	PNP	Cable, 3-wire	7,5	543 873	SMT-8M-PO-24V-K7,5-OE	



Cylinders with piston rods
Screw-in/screw-on cylinders



2.5

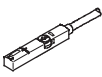

Compact cylinders DMM/EMM, Multimount

Accessories

FESTO

Ordering data – Proximity switches for T-slot, magnetic reed					Technical data → www.festo.com/catalogue/sm		
	Type of mounting	Switch output	Electrical connection	Cable length [m]	Part No.	Type	
N/O contact							
	Insertable in the slot from above, flush with cylinder profile	Contacting	Cable, 3-wire	2,5	543 862	SME-8M-DS-24V-K-2,5-OE	
				5,0	543 863	SME-8M-DS-24V-K-5,0-OE	
			Plug M8x1, 3-pin	Cable, 3-wire	2,5	543 872	SME-8M-ZS-24V-K-2,5-OE
				Cable, 3-wire	0,3	543 861	SME-8M-DS-24V-K-0,3-M8D
	Insertable in the slot lengthwise, flush with the cylinder profile	Contacting	Cable, 3-wire	2,5	150 855	SME-8-K-LED-24	
			Plug M8x1, 3-pin	0,3	150 857	SME-8-S-LED-24	
N/C contact							
	Insertable in the slot lengthwise, flush with the cylinder profile	Contacting	Cable, 3-wire	7,5	160 251	SME-8-0-K-LED-24	

Ordering data – Connecting cables				Technical data → www.festo.com/catalogue/nebu	
	Electrical connection, left	Electrical connection, right	Cable length [m]	Part No.	Type
	Straight socket, M8x1, 3-pin	Cable, open end, 3-wire	2,5	541 333	NEBU-M8G3-K-2.5-LE3
			5	541 334	NEBU-M8G3-K-5-LE3
	Straight socket, M12x1, 5-pin	Cable, open end, 3-wire	2,5	541 363	NEBU-M12G5-K-2.5-LE3
			5	541 364	NEBU-M12G5-K-5-LE3
	Angled socket, M8x1, 3-pin	Cable, open end, 3-wire	2,5	541 338	NEBU-M8W3-K-2.5-LE3
			5	541 341	NEBU-M8W3-K-5-LE3
	Angled socket, M12x1, 5-pin	Cable, open end, 3-wire	2,5	541 367	NEBU-M12W5-K-2.5-LE3
			5	541 370	NEBU-M12W5-K-5-LE3

Ordering data – One-way flow control valves				Technical data → Volume 2				
	Connection		Material	Part No.	Type			
	Thread	For tubing OD						
For exhaust air								
	M3	3	Metal design	175 041	GRLA-M3-QS-3			
		M5		3	193 137	GRLA-M5-QS-3-D		
				4	193 138	GRLA-M5-QS-4-D		
				6	193 139	GRLA-M5-QS-6-D		
	G1/8	3		193 142	GRLA-1/8-QS-3-D			
		4		193 143	GRLA-1/8-QS-4-D			
		6		193 144	GRLA-1/8-QS-6-D			
		8		193 145	GRLA-1/8-QS-8-D			
		For supply air						
				M3	3	Metal design	175 043	GRLZ-M3-QS-3
M5	3		193 153		GRLZ-M5-QS-3-D			
	4		193 154		GRLZ-M5-QS-4-D			
	6		193 155		GRLZ-M5-QS-6-D			
G1/8	3		193 156	GRLZ-1/8-QS-3-D				
	4		193 157	GRLZ-1/8-QS-4-D				
	6		193 158	GRLZ-1/8-QS-6-D				
	8		193 159	GRLZ-1/8-QS-8-D				

Cylinders with piston rods
Screw-in/screw-on cylinders

2.5

