



- Für präzises und materialschonendes Transportieren
- Leicht und robust
- 6 Saugerarten in verschiedenen Größen
- Sauger- $\varnothing$  2-100 mm
- Hohe Lebensdauer







# Sauger ESS

Lieferübersicht

FESTO



Vakuumsauggreifer

2.1

Typ	Sauger- $\varnothing$ [mm]	Sauger- halter Größe	Befesti- gungs- gewinde	Nenn- weite [mm]	Lebensmittel-Zulas- sung FDA	Werkstoffe						→ Seite	
						Fluorkautschuk	Nitrilkautschuk	Nitrilkautschuk antistatisch	Silikon	Polyurethan	Vulkollan®		
Standard, rund ESS-...-S...		2	1	$\varnothing 3$	0,6	■	■	■	■	■	■	-	6 / 2.1-53
		4			1,2	■	■	■	■	■	■	-	
		6	2	$\varnothing 4$	2,0	■	■	■	■	■	■	-	
		8			■	■	■	■	■	■	-		
		10	3	M4x0,7	2,0	■	■	■	■	■	■	-	6 / 2.1-53
		15			■	■	■	■	■	■	-		
		20	4	M6x1	3,0	■	■	■	■	■	■	-	
		30				■	■	■	■	■	-		
		40				■	■	■	■	■	-		
		50				■	■	■	■	■	-		
60		5	M10x1,5	6,0	■	■	■	■	■	■	-		
80					■	■	■	■	■	-			
100	■				■	■	■	■	-				
150	6	M20x2	10,0	■	■	■	■	■	■	-			
200				■	■	■	■	■	-				
Rund, extratief ESS-...-E...		15	3	M4x0,7	2,0	-	■	■	-	■	■	-	6 / 2.1-57
		20	4	M6x1	3,0	-	■	■	-	■	■	-	
		30				-	■	■	-	■	■	-	
		40				-	■	■	-	■	■	-	
		50	5	M10x1,5	6,0	-	■	■	-	■	■	-	
		60				-	■	■	-	■	■	-	
		80				-	■	■	-	■	■	-	
100	-	■	■	-	■	■	-	■	-				
Faltenbalg, rund, 1,5-fach ESS-...-B...		10	3	M4x0,7	2,0	-	-	■	-	■	■	-	6 / 2.1-60
		20	4	M6x1	3,0	-	-	■	-	■	■	-	
		30				-	■	-	■	■	-		
		40				-	■	-	■	■	-		
		50	5	M10x1,5	6,0	-	-	■	-	■	■	-	
80	-	■				-	■	■	-				
Faltenbalg, rund, 1,5-fach ESS-...-BT...		40	4	M6	2,5	-	-	-	-	-	-	■	6 / 2.1-62
				M10		-	-	-	-	-	-	■	
				G $\frac{1}{4}$ -I		-	-	-	-	-	-	■	
				G $\frac{1}{4}$		-	-	-	-	-	-	■	
		50	4	M6	2,5	-	-	-	-	-	-	■	
				M10		-	-	-	-	-	■		
				G $\frac{1}{4}$ -I		-	-	-	-	-	■		
		80	5	M10	2,5	-	-	-	-	-	-	■	
						G $\frac{1}{4}$ -I	-	-	-	-	-	■	
G $\frac{1}{4}$	-	-	-	-	-	-	■						
Faltenbalg, rund, 3,5-fach ESS-...-C...		10	3	M4x0,7	2,0	-	-	■	-	■	-	-	6 / 2.1-64
		20	4	M6x1	3,0	-	-	■	-	■	-	-	
		30				-	■	-	■	-	-		
		40				-	■	-	■	-	-		
		50				-	■	-	■	-	-		

# Sauger ESS

Lieferübersicht

Typ	Sauger- $\emptyset$ bzw. Sauger- Größe	Saugerhalter	Befestigungs- gewinde	Nennweite	Werkstoffe		→ Seite	
					Nitrilkautschuk	Vulkolan®		
	[mm]	Größe		[mm]				
Sauger oval ESS-...-O...		4x10	4	M6x1	3,0	■	-	6 / 2.1-66
		4x20						
		6x10						
		6x20						
		8x20						
		8x30						
		10x30						
		15x45	5	M10x1,5	6,0	■	-	
		20x60						
		25x75						
30x90								
Glockenform ESS-...-GT...		30	4	M6	2,5	-	■	6 / 2.1-68
				M10				
				G $\frac{1}{8}$ -I				
				G $\frac{1}{8}$				
		40	4	M6	2,5	-	■	
				M10				
				G $\frac{1}{4}$ -I				
				G $\frac{1}{4}$				
		50	4	M6	2,5	-	■	
				M10				
				G $\frac{1}{8}$ -I				
				G $\frac{1}{8}$				
		60	5	M10	2,5	-	■	
				G $\frac{1}{4}$ -I				
				G $\frac{1}{4}$				
		80	5	M10	5,5	-	■	
				G $\frac{1}{4}$ -I				
				G $\frac{1}{4}$				
100	5	M10	5,5	-	■			
		G $\frac{1}{4}$ -I						
		G $\frac{1}{4}$						







# Saugnapfe ESV

Lieferübersicht

FESTO

Vakuumsauggreifer

2.1

Typ	Sauger-Ø [mm]	Sauger- halter Größe	Befesti- gungs- gewinde	Lebensmittel-Zulas- sung FDA	Werkstoffe						→ Seite	
					Fluorkautschuk	Nitrilkautschuk	Nitrilkautschuk antistatisch	Silikon	Polyurethan	Vulkollan®		
Standard, rund ESV-...-S...		20	4	M6x1	■	■	■	■	■	■	-	6 / 2.1-53
		30										
		40										
		50										
		60	5	M10x1,5	■	■	■	-	■	■	-	
		80										
		100										
150	6	M20x2	■	■	■	-	■	■	-			
200												
Rund, extratief ESV-...-E...		20	4	M6x1	-	■	■	-	■	■	-	6 / 2.1-57
		30										
		40										
		50										
		60	5	M10x1,5	-	■	■	-	■	■	-	
		80										
		100										
Faltenbalg, rund, 1,5-fach ESV-...-B...		20	4	M6x1	-	-	■	-	■	■	-	6 / 2.1-60
		30										
		40										
		50										
80	5	M10x1,5	-	-	■	-	■	■	-			
100												
Faltenbalg, rund, 1,5-fach ESV-...-BT...		40	4	-	-	-	-	-	-	■	6 / 2.1-62	
		50										
		80	5	-	-	-	-	-	-	■		
Faltenbalg, rund, 3,5-fach ESV-...-C...		20	4	M6x1	-	-	■	-	■	-	-	6 / 2.1-64
		30										
		40										
		50	5	M10x1	-	-	■	-	■	-	-	
100												
Glockenform ESV-...-GT...		30	4	-	-	-	-	-	-	-	■	6 / 2.1-68
		40										
		50										
		60	5	-	-	-	-	-	-	-	■	
		80										
		100										

# Sauger ESS/Saugnapfe ESV

Typenschlüssel

FESTO

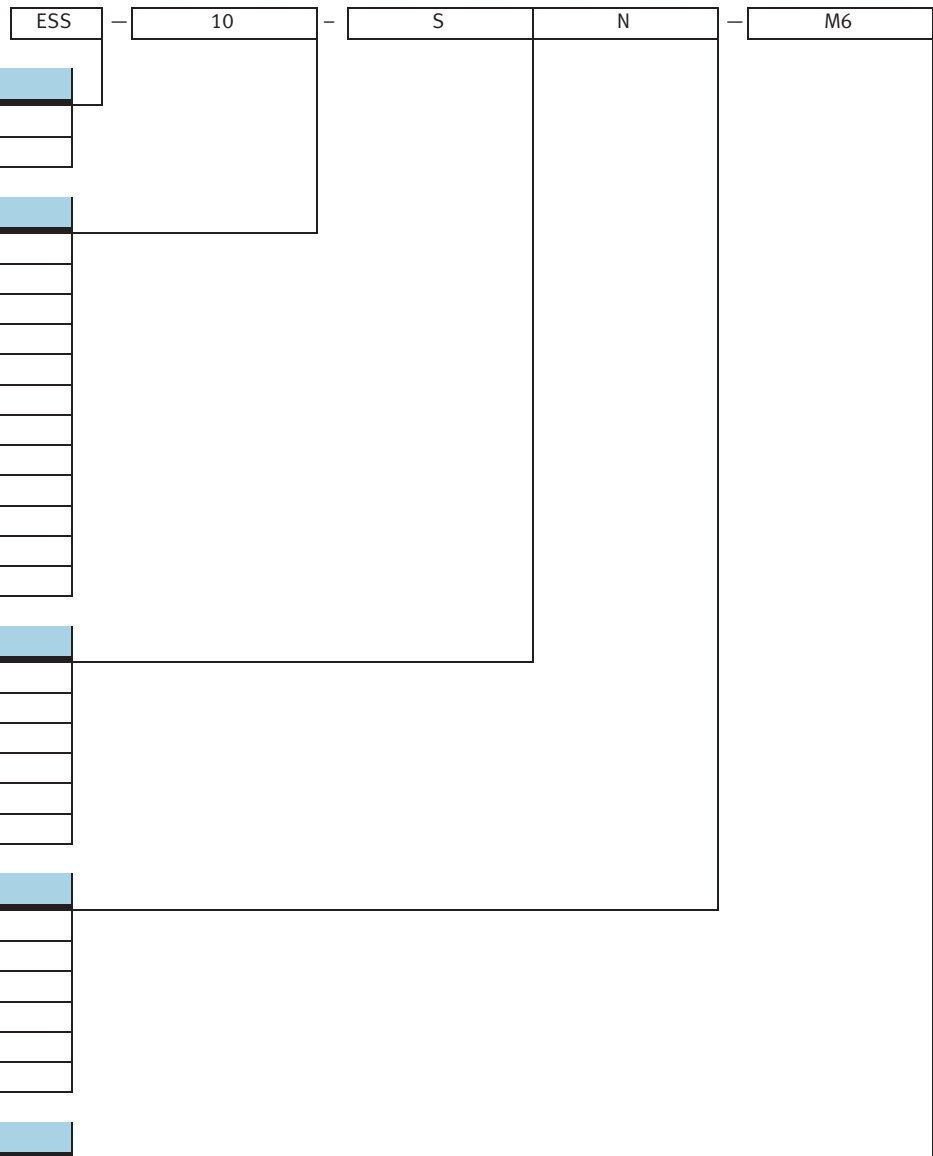

Typ	
ESS	Sauger
ESV	Saugnapf

Sauger-Ø bzw. Sauger-Größe [mm]	
2...200	rund
4x10	oval
4x20	oval
6x10	oval
6x20	oval
8x20	oval
8x30	oval
10x30	oval
15x45	oval
20x60	oval
25x75	oval
30x90	oval

Saugertyp	
S	Standard, rund
E	extratief
B	Faltenbalg, rund 1,5-fach
C	Faltenbalg, rund 3,5-fach
O	Oval
G	Glockenform

Werkstoffe	
F	Fluorkautschuk
N	Nitrilkautschuk
NA	Nitrilkautschuk antistatisch
S	Silikon
U	Polyurethan
T	Vulkollan®

Anschlussgrößen	
M6	Gewinde M6
M10	Gewinde M10
G <sup>1</sup> / <sub>8</sub>	Gewinde G <sup>1</sup> / <sub>8</sub>
G <sup>1</sup> / <sub>4</sub>	Gewinde G <sup>1</sup> / <sub>4</sub>
G <sup>1</sup> / <sub>8</sub> -I	Innengewinde G <sup>1</sup> / <sub>8</sub> -I
G <sup>1</sup> / <sub>4</sub> -I	Innengewinde G <sup>1</sup> / <sub>4</sub> -I

 Hinweis  
Mögliche Kombinationen entnehmen Sie den Bestellaangaben.

# Sauger ESS/Saugnapfe ESV

Datenblatt

Allgemeine Technische Daten						
Typ	ESS/ESV-...					
	F	N	NA	S	U	T
Betriebsmedium	atmosphärische Luft					
Einbaulage	beliebig					
Werkstoff	Fluorkautschuk	Nitrilkautschuk	Nitrilkautschuk antistatisch	Silikon	Polyurethan	Vulkollan®
Shore-Härte	60±5	50±5	50±5	50±5	60±5	72±5
Farbe	Grau	Schwarz	Schwarz mit weißem Punkt	Transparent	Blau	Rotbraun
Werkstoff-Hinweis	LABS-frei			LABS-haltige Stoffe enthalten		LABS-frei
	Kupfer-, PTFE- und silikonfrei → Bestellangaben					

Umweltbedingungen						
Typ	ESS/ESV-...					
	F	N	NA	S	U	T
Umgebungstemperatur [°C]	-10 ... +200	-10 ... +70	-10 ... +70	-30 ... +180	-20 ... +60	-10 ... +80
Korrosionsbeständigkeit KBK <sup>1)</sup>	1					2

- 1) Korrosionsbeständigkeitsklasse 1 nach Festo Norm 940 070  
Bauteile mit geringer Korrosionsbeanspruchung. Transport- und Lagerschutz. Teile ohne vorrangig dekorative Anforderung an die Oberfläche z. B. im nicht sichtbaren Innenbereich oder hinter Abdeckungen.
- Korrosionsbeständigkeitsklasse 2 nach Festo Norm 940 070  
Bauteile mit mäßiger Korrosionsbeanspruchung. Außenliegende sichtbare Teile mit vorrangig dekorativer Anforderung an die Oberfläche, die im direkten Kontakt zur umgebenden industriellen Atmosphäre bzw. Medien, wie Kühl- und Schmierstoffe stehen.

# Sauger ESS/Saugnöpfe ESV, Standard rund

FESTO

Datenblatt

ESS-...-S...  
ESV-...-S...

-  - Temperaturbereich  
-30 ... +200 °C

Funktion



-  - Durchmesser  
2 ... 200 mm

Lebensmittel-  
Zulassung FDA



Allgemeine Technische Daten								
Sauger-Ø [mm]	Saugerhalter passend zu	Befestigungs- gewinde	Wirksamer Sauger-Ø [mm]	Abreißkraft bei -0,7 bar [N]	Sauger- volumen <sup>3)</sup> [cm <sup>3</sup> ]	Min. Radius R <sup>2)</sup> des Werkstücks [mm]	Gewicht	
							ESS [g]	ESV [g]
2	Größe 1	Ø 3 <sup>1)</sup>	1,4	0,1	0,002	10	0,1	-
4			3,3	0,4	0,008	10	0,1	-
6	Größe 2	Ø 4 <sup>1)</sup>	5,2	1,1	0,015	15	0,2	-
8			7,2	2,3	0,030	20	0,2	-
10	Größe 3	M4x0,7	8,3	3,9	0,050	30	1,5	-
15			13,5	8,5	0,208	35	1,9	-
20	Größe 4	M6x1	17,6	16,3	0,318	60	6,4	1,6
30			18,4	40,8	0,867	110	9	2,7
40			26,5	69,6	1,566	230	16,3	7,4
50			33,3	105,8	2,387	330	22	11,2
60	Größe 5	M10x1,5	42,0	166,1	3,953	350	49	22
80			57,8	309,7	19,312	400	133	33
100			75,2	503,6	29,779	460	222	59
150	Größe 6	M20x2	114,3	900	173,826	480	719	361
200			151,7	1 610	245,454	680	1 198	840

- 1) Wird in den Saugerhalter auf- bzw. eingesteckt
- 2) Minimaler Wölbungsradius des zu greifenden Werkstücks
- 3) Zu evakuierendes Saugervolumen

Querkraft F [N] bei pu = -0,7 bar; Ra = 7 µm					
Sauger-Ø [mm]	ESS-...-SN	ESS-...-SS	ESS-...-SU	ESS-...-SF	ESS-...-SNA
2	0,5	0,5	0,5	0,5	0,5
4	0,5	0,5	0,5	0,5	0,5
6	3,5	2,5	3	1,5	2
8	9,5	3,5	5	3,5	4
10	3,5	4	7	4,5	7,5
15	10,5	6,5	9	10,5	13,5
20	11,5	10,5	23	15,5	14,5
30	19,5	23,5	19	22	20
40	60	25	83	25	49
50	135	84	130	69,5	81,5
60	136	85	151	117,5	-
80	315	104	295	139,5	-
100	600	130	482,5	299	-
150	675	400	1 000	480	-
200	850	425	1 000	500	-

Vakuumsauggreifer

2.1

# Sauger ESS/Saugnapfe ESV, Standard rund

Datenblatt

FESTO

## Abmessungen

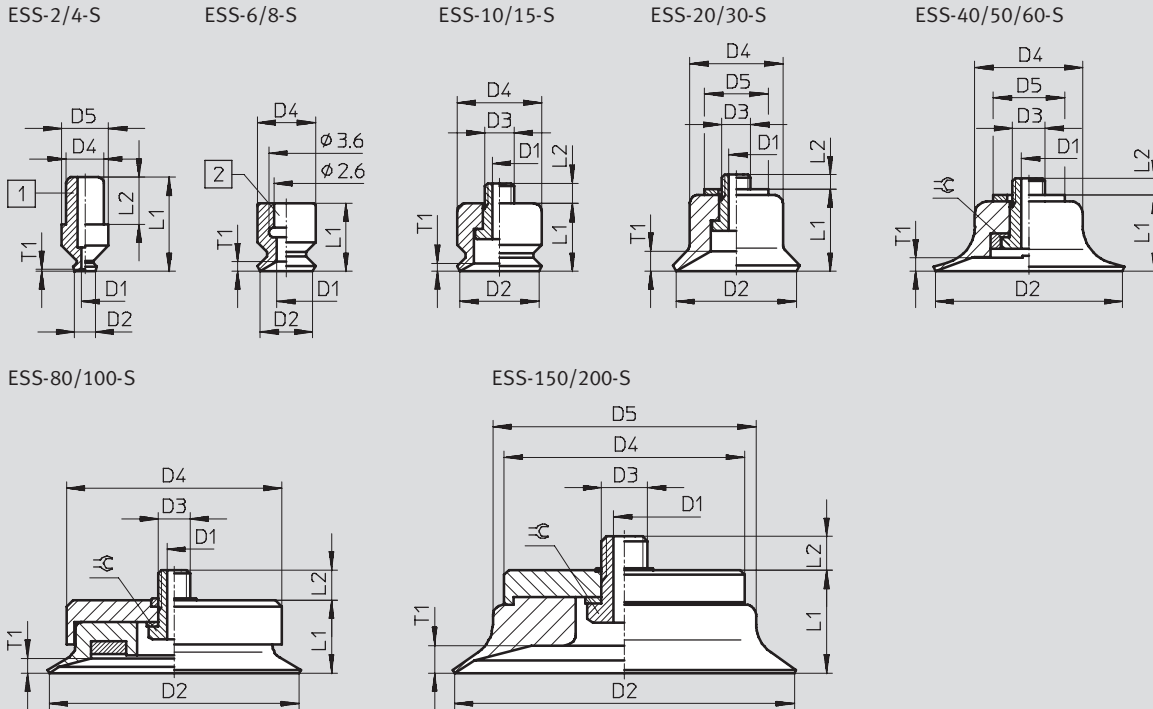

- 1 Zapfen zum Einstecken in Halter
- 2 Bohrung zum Aufstecken auf Halter

Typ Sauger	für Sauggreifer	D1 NW	D2 Ø	D3	D4 Ø	D5 Ø	L1	L2	T1	☞
ESS-2-S...	ESG-2-S...	Ø 0,6	2	–	3,2	4	8	4	0,2	–
ESS-4-S...	ESG-4-S...	Ø 1,2	4	–	3,2	4	8	4	0,6	–
ESS-6-S...	ESG-6-S...	Ø 2	6	–	6	–	7	–	1	–
ESS-8-S...	ESG-8-S...	Ø 2	8	–	6	–	5,5	–	1,1	–
ESS-10-S...	ESG-10-S...	☞ 2	10	M4x0,7	10	–	8	3	1	–
ESS-15-S...	ESG-15-S...	☞ 2	15	M4x0,7	11	–	9	3	2,4	–
ESS-20-S...	ESG-20-S...	☞ 3	20	M6x1	15	18	11,6	2,4	1,8	–
ESS-30-S...	ESG-30-S...	☞ 3	30	M6x1	17	18	12,6	3,4	2	–
ESS-40-S...	ESG-40-S...	☞ 3	40	M6x1	25	22	15,6	3,2	1,9	–
ESS-50-S...	ESG-50-S...	☞ 3	50	M6x1	30	22	16,6	3,2	1,6	–
ESS-60-S...	ESG-60-S...	Ø 6	60	M10x1,5	40	–	20,6	4,5	2,6	14
ESS-80-S...	ESG-80-S...	Ø 6	80	M10x1,5	68	–	23	9,4	4,7	14
ESS-100-S...	ESG-100-S...	Ø 6	100	M10x1,5	85	–	25	8,4	5,5	14
ESS-150-S...	ESG-150-S...	Ø 10	150	M20x2	105	115	45	13	12	27
ESS-200-S...	ESG-200-S...	Ø 10	200	M20x2	105	160	50	13	15	27

Vakuumsauggreifer

2.1



# Sauger ESS/Saugnapfe ESV, Standard rund

Datenblatt

**FESTO**

Bestellangaben				
Sauger-Ø [mm]	ESS		ESV	
	Teile-Nr.	Typ	Teile-Nr.	Typ
<b>Fluorkautschuk F</b>				
2	189 267	ESS-2-SF <sup>1)</sup>	-	
4	189 272	ESS-4-SF <sup>1)</sup>	-	
6	189 277	ESS-6-SF <sup>1)</sup>	-	
8	189 282	ESS-8-SF <sup>1)</sup>	-	
10	189 287	ESS-10-SF <sup>1)</sup>	-	
15	189 292	ESS-15-SF <sup>1)</sup>	-	
20	189 297	ESS-20-SF <sup>1)</sup>	190 982	ESV-20-SF
30	189 302	ESS-30-SF <sup>1)</sup>	190 987	ESV-30-SF
40	189 307	ESS-40-SF <sup>1)</sup>	190 992	ESV-40-SF
50	189 312	ESS-50-SF <sup>1)</sup>	190 997	ESV-50-SF
60	189 317	ESS-60-SF <sup>1)</sup>	191 002	ESV-60-SF
80	189 321	ESS-80-SF <sup>1)</sup>	191 006	ESV-80-SF
100	189 325	ESS-100-SF <sup>1)</sup>	191 010	ESV-100-SF
150	189 329	ESS-150-SF <sup>1)</sup>	191 014	ESV-150-SF
200	189 333	ESS-200-SF <sup>1)</sup>	191 018	ESV-200-SF
<b>Nitrilkautschuk N</b>				
2	189 264	ESS-2-SN <sup>1)</sup>	-	
4	189 269	ESS-4-SN <sup>1)</sup>	-	
6	189 274	ESS-6-SN <sup>1)</sup>	-	
8	189 279	ESS-8-SN <sup>1)</sup>	-	
10	189 284	ESS-10-SN <sup>1)</sup>	-	
15	189 289	ESS-15-SN <sup>1)</sup>	-	
20	189 294	ESS-20-SN <sup>1)</sup>	190 979	ESV-20-SN
30	189 299	ESS-30-SN <sup>1)</sup>	190 984	ESV-30-SN
40	189 304	ESS-40-SN <sup>1)</sup>	190 989	ESV-40-SN
50	189 309	ESS-50-SN <sup>1)</sup>	190 994	ESV-50-SN
60	189 314	ESS-60-SN <sup>1)</sup>	190 999	ESV-60-SN
80	189 318	ESS-80-SN <sup>1)</sup>	191 003	ESV-80-SN
100	189 322	ESS-100-SN <sup>1)</sup>	191 007	ESV-100-SN
150	189 326	ESS-150-SN <sup>1)</sup>	191 011	ESV-150-SN
200	189 330	ESS-200-SN <sup>1)</sup>	191 015	ESV-200-SN
<b>Nitrilkautschuk, antistatisch NA</b>				
2	189 268	ESS-2-SNA <sup>1)</sup>	-	
4	189 273	ESS-4-SNA <sup>1)</sup>	-	
6	189 278	ESS-6-SNA <sup>1)</sup>	-	
8	189 283	ESS-8-SNA <sup>1)</sup>	-	
10	189 288	ESS-10-SNA <sup>1)</sup>	-	
15	189 293	ESS-15-SNA <sup>1)</sup>	-	
20	189 298	ESS-20-SNA <sup>1)</sup>	190 983	ESV-20-SNA
30	189 303	ESS-30-SNA <sup>1)</sup>	190 988	ESV-30-SNA
40	189 308	ESS-40-SNA <sup>1)</sup>	190 993	ESV-40-SNA
50	189 313	ESS-50-SNA <sup>1)</sup>	190 998	ESV-50-SNA

1) Kupfer-, PTFE- und silikonfrei

# Sauger ESS/Saugnäpfe ESV, Standard rund

FESTO

Datenblatt

Vakuumsauggreifer

2.1

Bestellangaben				
Sauger-Ø [mm]	ESS		ESV	
	Teile-Nr.	Typ	Teile-Nr.	Typ
<b>Silikon S</b>				
2	189 266	ESS-2-SS	-	
4	189 271	ESS-4-SS	-	
6	189 276	ESS-6-SS	-	
8	189 281	ESS-8-SS	-	
10	189 286	ESS-10-SS	-	
15	189 291	ESS-15-SS	-	
20	189 296	ESS-20-SS	190 981	ESV-20-SS
30	189 301	ESS-30-SS	190 986	ESV-30-SS
40	189 306	ESS-40-SS	190 991	ESV-40-SS
50	189 311	ESS-50-SS	190 996	ESV-50-SS
60	189 316	ESS-60-SS	191 001	ESV-60-SS
80	189 320	ESS-80-SS	191 005	ESV-80-SS
100	189 324	ESS-100-SS	191 009	ESV-100-SS
150	189 328	ESS-150-SS	191 013	ESV-150-SS
200	189 332	ESS-200-SS	191 017	ESV-200-SS
<b>Polyurethan U</b>				
2	189 265	ESS-2-SU	-	
4	189 270	ESS-4-SU	-	
6	189 275	ESS-6-SU	-	
8	189 280	ESS-8-SU	-	
10	189 285	ESS-10-SU	-	
15	189 290	ESS-15-SU	-	
20	189 295	ESS-20-SU	190 980	ESV-20-SU
30	189 300	ESS-30-SU	190 985	ESV-30-SU
40	189 305	ESS-40-SU	190 990	ESV-40-SU
50	189 310	ESS-50-SU	190 995	ESV-50-SU
60	189 315	ESS-60-SU	191 000	ESV-60-SU
80	189 319	ESS-80-SU	191 004	ESV-80-SU
100	189 323	ESS-100-SU	191 008	ESV-100-SU
150	189 327	ESS-150-SU	191 012	ESV-150-SU
200	189 331	ESS-200-SU	191 016	ESV-200-SU

# Sauger ESS/Saugnapfe ESV, rund extratiief

Datenblatt

ESS-...-E...  
ESV-...-E...

-  - Temperaturbereich  
-30 ... +200 °C

Funktion



-  - Durchmesser  
15 ... 100 mm



Allgemeine Technische Daten								
Sauger-Ø [mm]	Saugerhalter passend zu	Befestigungs- gewinde	Wirksamer Sauger-Ø [mm]	Abreißkraft bei -0,7 bar [N]	Sauger- volumen <sup>2)</sup> [cm <sup>3</sup> ]	Min. Radius R <sup>1)</sup> des Werkstücks [mm]	Gewicht	
							ESS [g]	ESV [g]
15	Größe 3	M4x0,7	13,8	9,8	0,350	20	1,9	-
20	Größe 4	M6x1	17,2	17	0,840	30	6,4	1,6
30			20,9	37,2	2,120	50	9,2	2,9
40			28,1	67,6	4,040	80	16,9	8
50			36,9	103,6	7,900	100	23,4	12,6
60	Größe 5	M10x1,5	40,5	162,5	19,770	120	48	21
80			62,7	275	51,610	160	141	41
100			78,5	440,8	84,660	200	228	65

1) Minimaler Wölbungsradius des zu greifenden Werkstücks  
2) Zu evakuierendes Saugervolumen

Querkraft F [N] bei pu = -0,7 bar; Ra = 7 µm				
Sauger-Ø [mm]	ESS-...-EN	ESS-...-ES	ESS-...-EU	ESS-...-EF
15	9	10	15	14,5
20	14	13	16	15,5
30	24,5	21,5	41,5	18,5
40	53	28,5	46,5	22
50	115	42,5	62	60
60	130	63,5	134	62,5
80	216	107,5	136,5	148,5
100	351	150	352,5	254,5

# Sauger ESS/Saugnäpfe ESV, rund extratief

Datenblatt

FESTO

## Abmessungen

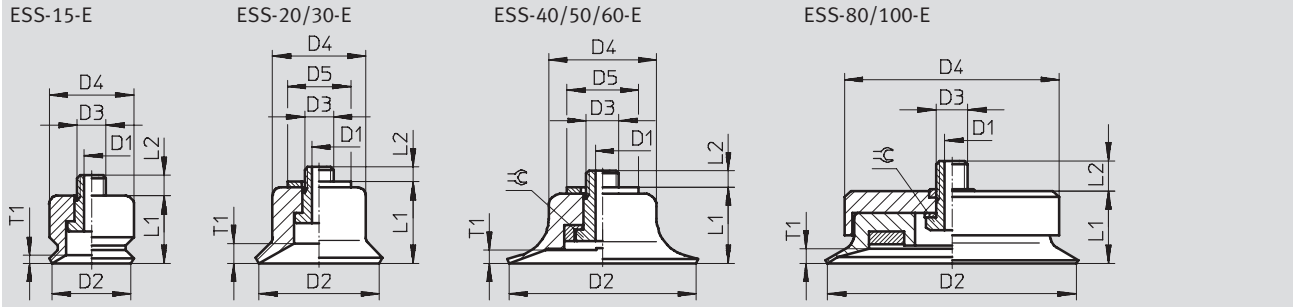

Typ Sauger	für Sauggreifer	D1 NW	D2 Ø	D3	D4 Ø	D5 Ø	L1	L2	T1	⊖
ESS-15-E...	ESG-15-E...	≈⊖ 2	15	M4x0,7	11	–	10	3	2,9	–
ESS-20-E...	ESG-20-E...	≈⊖ 3	20	M6x1	15	18	12,6	2,4	3	–
ESS-30-E...	ESG-30-E...	≈⊖ 3	30	M6x1	17	18	15,6	3,4	4,5	–
ESS-40-E...	ESG-40-E...	≈⊖ 3	40	M6x1	25	22	19,1	3,2	4,5	–
ESS-50-E...	ESG-50-E...	≈⊖ 3	50	M6x1	30	22	21,1	3,9	6,5	–
ESS-60-E...	ESG-60-E...	Ø 6	60	M10x1,5	40	–	27,6	5,4	9,5	14
ESS-80-E...	ESG-80-E...	Ø 6	80	M10x1,5	68	–	33	9,4	8,6	14
ESS-100-E...	ESG-100-E...	Ø 6	100	M10x1,5	85	–	33	8,4	10,7	14

Vakuumsauggreifer

2.1

# Sauger ESS/Saugnapfe ESV, rund extratief

Datenblatt

**FESTO**

Bestellangaben				
Sauger-Ø [mm]	ESS		ESV	
	Teile-Nr.	Typ	Teile-Nr.	Typ
<b>Fluorkautschuk F</b>				
15	189 337	ESS-15-EF <sup>1)</sup>	–	
20	189 341	ESS-20-EF <sup>1)</sup>	191 026	ESV-20-EF
30	189 345	ESS-30-EF <sup>1)</sup>	191 030	ESV-30-EF
40	189 349	ESS-40-EF <sup>1)</sup>	191 034	ESV-40-EF
50	189 353	ESS-50-EF <sup>1)</sup>	191 038	ESV-50-EF
60	189 357	ESS-60-EF <sup>1)</sup>	191 042	ESV-60-EF
80	189 361	ESS-80-EF <sup>1)</sup>	191 046	ESV-80-EF
100	189 365	ESS-100-EF <sup>1)</sup>	191 050	ESV-100-EF
<b>Nitrilkautschuk N</b>				
15	189 334	ESS-15-EN <sup>1)</sup>	–	
20	189 338	ESS-20-EN <sup>1)</sup>	191 023	ESV-20-EN
30	189 342	ESS-30-EN <sup>1)</sup>	191 027	ESV-30-EN
40	189 346	ESS-40-EN <sup>1)</sup>	191 031	ESV-40-EN
50	189 350	ESS-50-EN <sup>1)</sup>	191 035	ESV-50-EN
60	189 354	ESS-60-EN <sup>1)</sup>	191 039	ESV-60-EN
80	189 358	ESS-80-EN <sup>1)</sup>	191 043	ESV-80-EN
100	189 362	ESS-100-EN <sup>1)</sup>	191 047	ESV-100-EN
<b>Silikon S</b>				
15	189 336	ESS-15-ES	–	
20	189 340	ESS-20-ES	191 025	ESV-20-ES
30	189 344	ESS-30-ES	191 029	ESV-30-ES
40	189 348	ESS-40-ES	191 033	ESV-40-ES
50	189 352	ESS-50-ES	191 037	ESV-50-ES
60	189 356	ESS-60-ES	191 041	ESV-60-ES
80	189 360	ESS-80-ES	191 045	ESV-80-ES
100	189 364	ESS-100-ES	191 049	ESV-100-ES
<b>Polyurethan U</b>				
15	189 335	ESS-15-EU	–	
20	189 339	ESS-20-EU	191 024	ESV-20-EU
30	189 343	ESS-30-EU	191 028	ESV-30-EU
40	189 347	ESS-40-EU	191 032	ESV-40-EU
50	189 351	ESS-50-EU	191 036	ESV-50-EU
60	189 355	ESS-60-EU	191 040	ESV-60-EU
80	189 359	ESS-80-EU	191 044	ESV-80-EU
100	189 363	ESS-100-EU	191 048	ESV-100-EU

1) Kupfer-, PTFE- und silikonfrei

# Sauger ESS/Saugnäpfe ESV, Faltenbalg, rund 1,5-fach

Datenblatt



ESS-...-B...  
ESV-...-B...

- - Temperaturbereich  
-30 ... +180 °C

Funktion



- - Durchmesser  
10 ... 80 mm



## Allgemeine Technische Daten

Sauger-Ø [mm]	Saugerhalter passend zu	Befestigungs- gewinde	Wirksamer Sauger-Ø [mm]	Abreißkraft bei -0,7 bar [N]	Sauger- volumen <sup>2)</sup> [cm <sup>3</sup> ]	Min. Radius R <sup>1)</sup> des Werkstücks [mm]	Höhenaus- gleich H1 [mm]	Gewicht	
								ESS [g]	ESV [g]
10	Größe 3	M4x0,7	7,4	4,7	0,380	20	4	1,8	-
20	Größe 4	M6x1	14,3	12,9	1,600	40	6	6,7	1,9
30			20,3	26,2	4,070	80	8	9,9	3,6
40			25,2	52,3	8,870	90	9,5	18,7	9,8
50			31,8	72,6	14,230	150	11	24,7	13,9
80	Größe 5	M10x1,5	55	213,6	63,900	430	10	139	39

- 1) Minimaler Wölbungsradius des zu greifenden Werkstücks  
2) Zu evakuierendes Saugervolumen

Vakuumsauggreifer

## 2.1

### Höhenausgleich H1

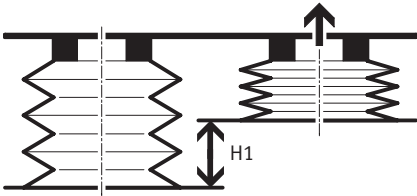

### Querkraft F [N] bei pu = -0,7 bar; Ra = 7 µm

Sauger-Ø [mm]	ESS-...-BN	ESS-...-BS	ESS-...-BU
10	4,5	2,5	3
20	9,5	8	9,5
30	24,5	16	21,5
40	32,5	32,5	33
50	55,5	38	47
80	199,5	93	132,5

# Sauger ESS/Saugnapfe ESV, Faltenbalg, rund 1,5-fach

Datenblatt

FESTO

## Abmessungen

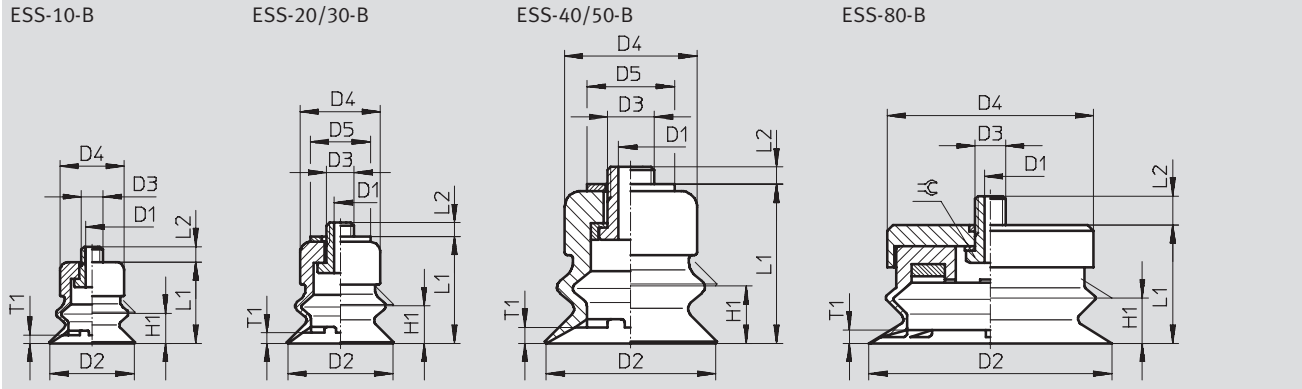

Typ Sauger	für Sauggreifer	D1 NW	D2 Ø	D3	D4 Ø	D5 Ø	H1	L1	L2	T1	≈C
ESS-10-B...	ESG-10-B...	≈C 2	10	M4x0,7	10	-	4	16	3	1	-
ESS-20-B...	ESG-20-B...	≈C 3	20	M6x1	15	18	6	20,6	2,4	2	-
ESS-30-B...	ESG-30-B...	≈C 3	30	M6x1	17	18	8	24,6	3,4	2,5	-
ESS-40-B...	ESG-40-B...	≈C 3	40	M6x1	25	22	9,5	31,6	3,2	4	-
ESS-50-B...	ESG-50-B...	≈C 3	50	M6x1	30	22	11	33,6	3,2	4	-
ESS-80-B...	ESG-80-B...	Ø 6	80	M10x1,5	68	-	10	39	9,4	2	14

## Bestellangaben

Sauger-Ø [mm]	ESS		ESV	
	Teile-Nr.	Typ	Teile-Nr.	Typ
<b>Nitrilkautschuk N</b>				
10	189 374	ESS-10-BN <sup>1)</sup>	-	-
20	189 378	ESS-20-BN <sup>1)</sup>	191 054	ESV-20-BN
30	189 382	ESS-30-BN <sup>1)</sup>	191 057	ESV-30-BN
40	189 386	ESS-40-BN <sup>1)</sup>	191 060	ESV-40-BN
50	189 390	ESS-50-BN <sup>1)</sup>	191 063	ESV-50-BN
80	189 394	ESS-80-BN <sup>1)</sup>	191 066	ESV-80-BN
<b>Silikon S</b>				
10	189 376	ESS-10-BS	-	-
20	189 380	ESS-20-BS	191 056	ESV-20-BS
30	189 384	ESS-30-BS	191 059	ESV-30-BS
40	189 388	ESS-40-BS	191 062	ESV-40-BS
50	189 392	ESS-50-BS	191 065	ESV-50-BS
80	189 396	ESS-80-BS	191 068	ESV-80-BS
<b>Polyurethan U</b>				
10	189 375	ESS-10-BU	-	-
20	189 379	ESS-20-BU	191 055	ESV-20-BU
30	189 383	ESS-30-BU	191 058	ESV-30-BU
40	189 387	ESS-40-BU	191 061	ESV-40-BU
50	189 391	ESS-50-BU	191 064	ESV-50-BU
80	189 395	ESS-80-BU	191 067	ESV-80-BU

1) Kupfer-, PTFE- und silikonfrei

# Sauger ESS/Saugnäpfe ESV, Faltenbalg, rund 1,5-fach

FESTO

Datenblatt

ESS-...-BT-...  
ESV-...-BT

-  - Temperaturbereich  
-10 ... +80 °C

Funktion



-  - Durchmesser  
40 ... 80 mm



Allgemeine Technische Daten							
Sauger-Ø [mm]	Saugerhalter passend zu	Befestigungsgewinde	Abreißkraft bei -0,7 bar [N]	Min. Radius R <sup>1)</sup> des Werkstücks [mm]	Volumen [cm <sup>3</sup> ]	Gewicht	
						ESS [g]	ESV [g]
40	Größe 4	M6x1	59	35	9,70	18	10,5
	Größe 5	M10x1,5			9,71	19	
	-	G <sup>1</sup> / <sub>4</sub> -I Innengewinde			10,00	19	
	-	G <sup>1</sup> / <sub>4</sub> Außengewinde			9,73	20,5	
50	Größe 4	M6x1	100	40	17,50	24	16,2
	Größe 5	M10x1,5			17,51	25	
	-	G <sup>1</sup> / <sub>4</sub> -I Innengewinde			17,80	25	
	-	G <sup>1</sup> / <sub>4</sub> Außengewinde			17,53	26	
80	Größe 5	M10x1,5	237	100	58,50	84,5	57,2
	-	G <sup>1</sup> / <sub>4</sub> -I Innengewinde			58,50	87,5	
	-	G <sup>1</sup> / <sub>4</sub> Außengewinde			58,50	85,5	

1) Minimaler Wölbungsradius des zu greifenden Werkstücks



# Sauger ESS/Saugnapfe ESV, Faltenbalg, rund 1,5-fach

Datenblatt

FESTO

## Abmessungen

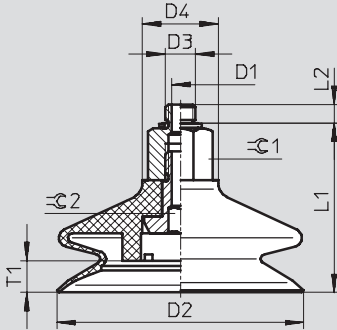

Typ	D1 Ø NW	D2 Ø	D3	D4 Ø	L1	L2	T1	1	2
ESS-40-BT	2,5	40	M6	20	36	3,45	9	15	4
			M10		36,3	6,2		17	
ESS-40-BT-I			G $\frac{1}{4}$		48,3	-			
ESS-50-BT	2,5	50	M6	20	38,05	3,45	8	15	4
			M10		38,3	6,2		17	
ESS-50-BT-I			G $\frac{1}{4}$		50,3	-			
ESS-80-BT	2,5	80	M10	20	53,3	6,2	10,5	17	8
			G $\frac{1}{4}$			5,8			
ESS-80-BT-I			G $\frac{1}{4}$		60,8	-			

## Bestellangaben

Sauger-Ø [mm]	Anschluss	ESS		ESV	
		Teile-Nr.	Typ	Teile-Nr.	Typ
40	M6	525 989	ESS-40-BT-M6 <sup>1)</sup>	-	
	M10	525 990	ESS-40-BT-M10 <sup>1)</sup>	-	
	G $\frac{1}{4}$ Innengewinde	525 991	ESS-40-BT-G $\frac{1}{4}$ -I <sup>1)</sup>	-	
	G $\frac{1}{4}$	525 992	ESS-40-BT-G $\frac{1}{4}$ <sup>1)</sup>	-	
	-	-	-	526 006	ESV-40-BT <sup>1)</sup>
50	M6	525 993	ESS-50-BT-M6 <sup>1)</sup>	-	
	M10	525 994	ESS-50-BT-M10 <sup>1)</sup>	-	
	G $\frac{1}{4}$ Innengewinde	525 995	ESS-50-BT-G $\frac{1}{4}$ -I <sup>1)</sup>	-	
	G $\frac{1}{4}$	525 996	ESS-50-BT-G $\frac{1}{4}$ <sup>1)</sup>	-	
	-	-	-	526 007	ESV-50-BT <sup>1)</sup>
80	M10	525 997	ESS-80-BT-M10 <sup>1)</sup>	-	
	G $\frac{1}{4}$ Innengewinde	525 998	ESS-80-BT-G $\frac{1}{4}$ -I <sup>1)</sup>	-	
	G $\frac{1}{4}$	525 999	ESS-80-BT-G $\frac{1}{4}$ <sup>1)</sup>	-	
	-	-	-	526 008	ESV-80-BT <sup>1)</sup>

1) Kupfer-, PTFE- und silikonfrei

# Sauger ESS/Saugnöpfe ESV, Faltenbalg, rund 3,5-fach

Datenblatt



ESS-...-C...  
ESV-...-C...

- - Temperaturbereich  
-30 ... +180 °C

Funktion



- - Durchmesser  
10 ... 50 mm



## Allgemeine Technische Daten

Sauger-Ø [mm]	Saugerhalter passend zu	Befestigungs- gewinde	Wirksamer Sauger-Ø [mm]	Abreißkraft bei -0,7 bar [N]	Sauger- volumen <sup>2)</sup> [cm <sup>3</sup> ]	Min. Radius R <sup>1)</sup> des Werkstücks [mm]	Höhenaus- gleich H1 [mm]	Gewicht	
								ESS [g]	ESV [g]
10	Größe 3	M4x0,7	6,9	3,9	0,290	25	3,3	1,6	-
20	Größe 4	M6x1	14,5	8,2	2,750	50	7	6,9	2,1
30			20,9	20,8	9,470	80	10,5	12,2	5,8
40			28,2	42,4	19,720	100	12,8	21,9	13
50			32,8	63,4	38,920	180	17,5	32,1	21,3

- 1) Minimaler Wölbungsradius des zu greifenden Werkstücks  
2) Zu evakuierendes Saugervolumen

## Höhenausgleich H1

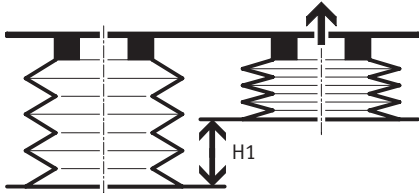

## Querkraft F [N] bei pu = -0,7 bar; Ra = 7 µm

Sauger-Ø [mm]	ESS-...-CN	ESS-...-CS
10	1,5	1
20	6,5	7
30	11,5	11
40	47,5	13
50	49	45,5

# Sauger ESS/Saugnapfe ESV, Faltenbalg, rund 3,5-fach

Datenblatt

FESTO

## Abmessungen

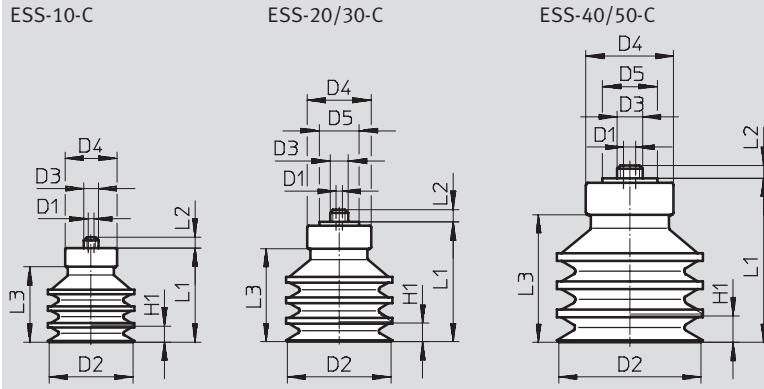

Typ Sauger	für Sauggreifer	D1 ≈ NW	D2 ∅	D3	D4 ∅	D5 ∅	H1	L1	L2	L3
ESS-10-C...	ESG-10-C...	2	10	M4x0,7	10	-	3,3	12,7	3	8,7
ESS-20-C...	ESG-20-C...	3	20	M6x1	15	18	7	23	2,4	16,4
ESS-30-C...	ESG-30-C...	3	30	M6x1	18	18	10,5	34,3	3,4	26,2
ESS-40-C...	ESG-40-C...	3	40	M6x1	25	22	12,8	39,6	3,2	31
ESS-50-C...	ESG-50-C...	3	50	M6x1	30	22	17,5	48	3,2	39,4

## Bestellangaben

Sauger-∅ [mm]	ESS		ESV	
	Teile-Nr.	Typ	Teile-Nr.	Typ
<b>Nitrilkautschuk N</b>				
10	189 398	ESS-10-CN <sup>1)</sup>	-	-
20	189 400	ESS-20-CN <sup>1)</sup>	191 071	ESV-20-CN
30	189 402	ESS-30-CN <sup>1)</sup>	191 073	ESV-30-CN
40	189 404	ESS-40-CN <sup>1)</sup>	191 075	ESV-40-CN
50	189 406	ESS-50-CN <sup>1)</sup>	191 077	ESV-50-CN
<b>Silikon S</b>				
10	189 399	ESS-10-CS	-	-
20	189 401	ESS-20-CS	191 072	ESV-20-CS
30	189 403	ESS-30-CS	191 074	ESV-30-CS
40	189 405	ESS-40-CS	191 076	ESV-40-CS
50	189 407	ESS-50-CS	191 078	ESV-50-CS

1) Kupfer-, PTFE- und silikonfrei

# Sauger ESS, oval

Datenblatt

FESTO

ESS-...-0...

-  - Temperaturbereich  
-10 ... +70 °C

Funktion



Allgemeine Technische Daten						
Sauger-Größe [mm]	Saugerhalter passend zu	Befestigungs- gewinde	Wirksame Fläche [cm <sup>2</sup> ]	Abreißkraft bei -0,7 bar [N]	Saugervolumen <sup>1)</sup> [cm <sup>3</sup> ]	Gewicht [g]
4x10	Größe 4	M6x1	0,29	2	0,064	2
4x20			0,57	3,4	0,112	2,5
6x10			0,35	2,9	0,106	2
6x20			0,74	5,9	0,196	2,5
8x20			0,89	8	0,256	2,5
8x30			1,36	10,9	0,376	3
10x30			2,23	15,2	0,350	2,9
15x45	Größe 5	M10x1,5	4,84	32	1,570	23,8
20x60			9,12	62,8	3,690	30,8
25x75			14,67	92,5	6,700	46,8
30x90			21,83	134,4	10,170	55,3

1) Zu evakuierendes Saugervolumen

Querkraft F [N] bei pu = -0,7 bar und Ra = 7 µm		
Sauger-Größe [mm]	Horizontal	Vertikal
4x10	3,5	5
4x20	4,5	11
6x10	8,5	12
6x20	9	12,5
8x20	11	13
8x30	17	13,5
10x30	23	16
15x45	43	35
20x60	116	63
25x75	125,5	115
30x90	201	134,5

# Sauger ESS, oval

Datenblatt

FESTO

## Abmessungen

ESS-4x10 ... 10x30-0

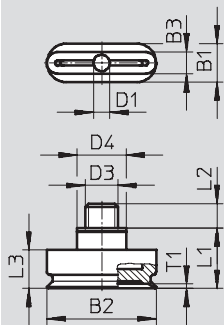

ESS-15x45 ... 30x90-0

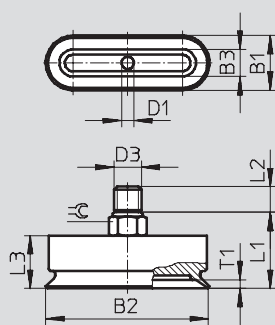

Typ	für Sauggreifer	B1	B2	B3	D1 ∅ NW	D3	D4 ∅	L1	L2	L3	T1	☉
ESS-4x10-0...	ESG-4x10-0...	7	10	4	2,5	M6x1	9	11,1	4,4	7	0,8	-
ESS-4x20-0...	ESG-4x20-0...	7	20	4	2,5	M6x1	9	11,1	4,4	7	0,8	-
ESS-6x10-0...	ESG-6x10-0...	7	10	6	2,5	M6x1	9	11,1	4,4	7	1	-
ESS-6x20-0...	ESG-6x20-0...	7	20	6	2,5	M6x1	9	11,1	4,4	7	1	-
ESS-8x20-0...	ESG-8x20-0...	7	20	8	2,5	M6x1	9	11,1	4,4	7	1	-
ESS-8x30-0...	ESG-8x30-0...	7	30	8	2,5	M6x1	9	11,1	4,4	7	1	-
ESS-10x30-0...	ESG-10x30-0...	10	30	7	2,5	M6x1	9	11,1	4,4	7	1,1	-
ESS-15x45-0...	ESG-15x45-0...	15	45	15	6	M10x1,5	-	25,5	8,5	18,5	2,5	12
ESS-20x60-0...	ESG-20x60-0...	20	60	20	6	M10x1,5	-	26,3	8,5	19,3	3,2	12
ESS-25x75-0...	ESG-25x75-0...	25	75	25	6	M10x1,5	-	28	8,5	21	3,7	12
ESS-30x90-0...	ESG-30x90-0...	30	90	30	6	M10x1,5	-	28,5	8,5	21,5	3,7	12

## Bestellangaben

Sauger-Größe [mm]	ESS	
	Teile-Nr.	Typ
Nitrilkautschuk N		
4x10	189 408	ESS-4X10-ON <sup>1)</sup>
4x20	189 409	ESS-4X20-ON <sup>1)</sup>
6x10	189 410	ESS-6X10-ON <sup>1)</sup>
6x20	189 411	ESS-6X20-ON <sup>1)</sup>
8x20	189 412	ESS-8X20-ON <sup>1)</sup>
8x30	189 413	ESS-8X30-ON <sup>1)</sup>
10x30	189 414	ESS-10X30-ON <sup>1)</sup>
15x45	189 415	ESS-15X45-ON <sup>1)</sup>
20x60	189 416	ESS-20X60-ON <sup>1)</sup>
25x75	189 417	ESS-25X75-ON <sup>1)</sup>
30x90	189 418	ESS-30X90-ON <sup>1)</sup>

1) Kupfer-, PTFE- und silikonfrei

# Sauger ESS/Saugnöpfe ESV, Glockenform

Datenblatt



ESS-...-GT-...  
ESV-...-GT

- - Temperaturbereich  
-10 ... +80 °C

Funktion



- - Durchmesser  
30 ... 100 mm

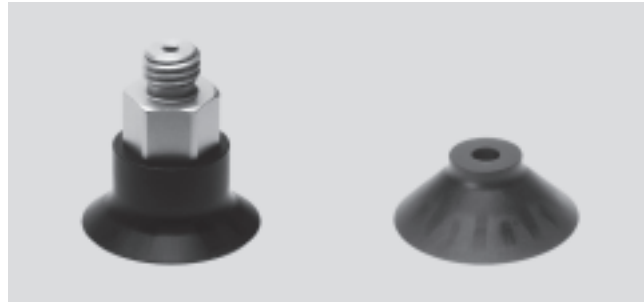

Allgemeine Technische Daten								
Sauger-Ø [mm]	Saugerhalter passend zu	Befestigungsgewinde	Abreißkraft bei -0,7 bar [N]	Min. Radius R <sup>1)</sup> des Werkstücks [mm]	Volumen [cm <sup>3</sup> ]	Gewicht		
						ESS [g]	ESV [g]	
30	Größe 4	M6x1	36	26	2,3	12	4,2	
	Größe 5	M10x1,5				13		
	-	G1/8-I Innengewinde				14		
	-	G1/8 Außengewinde				13		
40	Größe 4	M6x1	64	35	5,1	14	5,7	
	Größe 5	M10x1,5				15		
	-	G1/4-I Innengewinde				5,4		14,5
	-	G1/4 Außengewinde				5,1		16
50	Größe 4	M6x1	97	40	11,2	17	9,2	
	Größe 5	M10x1,5				18		
	-	G1/4-I Innengewinde				11,5		18
	-	G1/4 Außengewinde				11,2		21
60	Größe 5	M10x1,5	134	75	12,3	20	10,7	
	-	G1/4-I Innengewinde				19,5		
	-	G1/4 Außengewinde				21		
80	Größe 5	M10x1,5	245	100	28,0	28	30,9	
	-	G1/4-I Innengewinde				61		
	-	G1/4 Außengewinde				60		
100	Größe 5	M10x1,5	375	135	53,2	86,5	58,9	
	-	G1/4-I Innengewinde				89,5		
	-	G1/4 Außengewinde				87,5		

1) Minimaler Wölbungsradius des zu greifenden Werkstücks

# Sauger ESS/Saugnapfe ESV, Glockenform

Datenblatt

FESTO

## Abmessungen

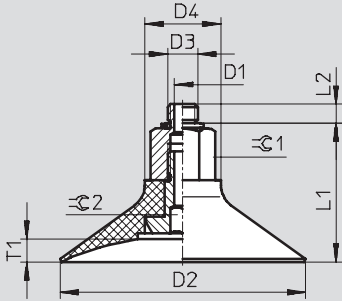

Typ	D1 ∅ NW	D2 ∅	D3	D4 ∅	L1	L2	T1	R1	R2
ESS-30-GT	2,5	30	M6	20	27,55	3,45	3,5	15	4
ESS-30-GT-I			M10		27,8	6,2		17	
			G $\frac{1}{8}$		36,8	4,7		15	
ESS-40-GT	2,5	40	M6	20	29,55	3,45	5,5	15	4
ESS-40-GT-I			M10		29,8	6,2		17	
			G $\frac{1}{4}$		30,2	5,8		42,2	
ESS-50-GT	2,5	50	M6	20	32,05	3,45	8	15	4
ESS-50-GT-I			M10		32,3	6,2		17	
			G $\frac{1}{4}$		32,7	5,8		44,7	
ESS-60-GT	5,5	60	M10	20	34,3	6,2	6	17	4
ESS-60-GT-I			G $\frac{1}{4}$		34,7	5,8			
ESS-80-GT	5,5	80	M10	25	43,3	6,2	7,5	22	8
ESS-80-GT-I			G $\frac{1}{4}$			54,7			
ESS-100-GT	5,5	100	M10	25	47,8	6,2	9	22	8
ESS-100-GT-I			G $\frac{1}{4}$			48,2			

Vakuumsauggreifer

2.1

# Sauger ESS/Saugnäpfe ESV, Glockenform

FESTO

Datenblatt

Vakuumsauggreifer

2.1

Bestellangaben					
Sauger-Ø [mm]	Anschluss	ESS		ESV	
		Teile-Nr.	Typ	Teile-Nr.	Typ
30	M6	525 968	ESS-30-GT-M6 <sup>1)</sup>	-	
	M10	525 969	ESS-30-GT-M10 <sup>1)</sup>	-	
	G $\frac{1}{8}$ Innengewinde	525 970	ESS-30-GT-G $\frac{1}{8}$ -I <sup>1)</sup>	-	
	G $\frac{1}{8}$	525 971	ESS-30-GT-G $\frac{1}{8}$ <sup>1)</sup>	-	
	-	-	-	526 000	ESV-30-GT <sup>1)</sup>
40	M6	525 972	ESS-40-GT-M6 <sup>1)</sup>	-	
	M10	525 973	ESS-40-GT-M10 <sup>1)</sup>	-	
	G $\frac{1}{4}$ Innengewinde	525 974	ESS-40-GT-G $\frac{1}{4}$ -I <sup>1)</sup>	-	
	G $\frac{1}{4}$	525 975	ESS-40-GT-G $\frac{1}{4}$ <sup>1)</sup>	-	
	-	-	-	526 001	ESV-40-GT <sup>1)</sup>
50	M6	525 976	ESS-50-GT-M6 <sup>1)</sup>	-	
	M10	525 977	ESS-50-GT-M10 <sup>1)</sup>	-	
	G $\frac{1}{4}$ Innengewinde	525 978	ESS-50-GT-G $\frac{1}{4}$ -I <sup>1)</sup>	-	
	G $\frac{1}{4}$	525 979	ESS-50-GT-G $\frac{1}{4}$ <sup>1)</sup>	-	
	-	-	-	526 002	ESV-50-GT <sup>1)</sup>
60	M10	525 980	ESS-60-GT-M10 <sup>1)</sup>	-	
	G $\frac{1}{4}$ Innengewinde	525 981	ESS-60-GT-G $\frac{1}{4}$ -I <sup>1)</sup>	-	
	G $\frac{1}{4}$	525 982	ESS-60-GT-G $\frac{1}{4}$ <sup>1)</sup>	-	
	-	-	-	526 003	ESV-60-GT <sup>1)</sup>
80	M10	525 983	ESS-80-GT-M10 <sup>1)</sup>	-	
	G $\frac{1}{4}$ Innengewinde	525 984	ESS-80-GT-G $\frac{1}{4}$ -I <sup>1)</sup>	-	
	G $\frac{1}{4}$	525 985	ESS-80-GT-G $\frac{1}{4}$ <sup>1)</sup>	-	
	-	-	-	526 004	ESV-80-GT <sup>1)</sup>
100	M10	525 986	ESS-100-GT-M10 <sup>1)</sup>	-	
	G $\frac{1}{4}$ Innengewinde	525 987	ESS-100-GT-G $\frac{1}{4}$ -I <sup>1)</sup>	-	
	G $\frac{1}{4}$	525 988	ESS-100-GT-G $\frac{1}{4}$ <sup>1)</sup>	-	
	-	-	-	526 005	ESV-100-GT <sup>1)</sup>

1) Kupfer-, PTFE- und silikonfrei