

- 1 - Auslauftyp
Lieferbar bis 2008

Normzylinder DNU/DNUL, DIN ISO 6431

FESTO

Für Neukonstruktionen
Normzylinder DNC verwenden
→ 1 / 1.2-24

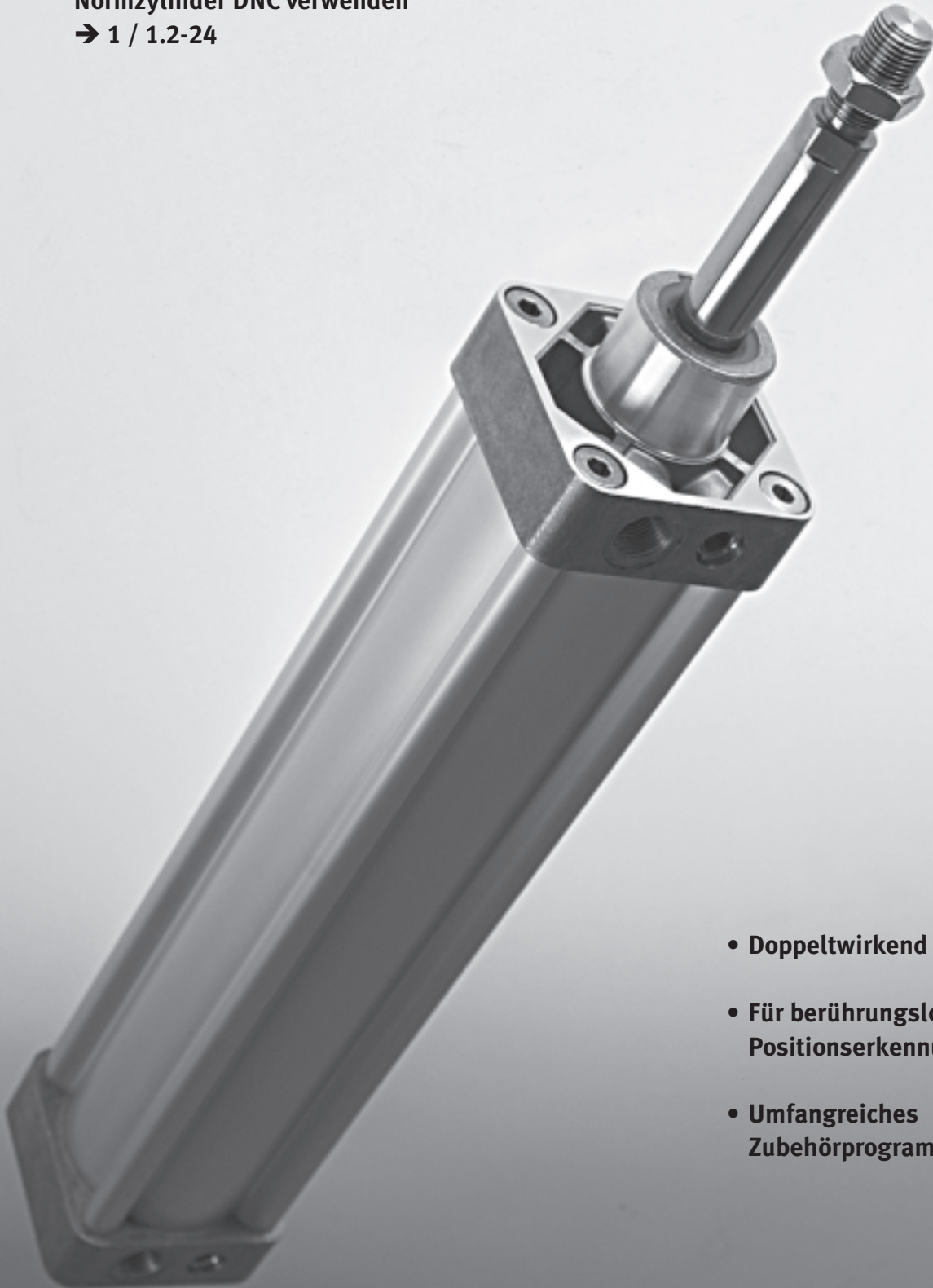

- Doppeltwirkend
- Für berührungslose Positionserkennung
- Umfangreiches Zubehörprogramm

Normbasierte Zylinder
DIN ISO 6431

1.3

Normzylinder DNU/DNUL, DIN ISO 6431

Lieferübersicht

FESTO

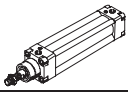
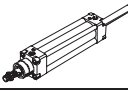
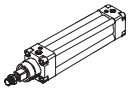
Funktion	Ausführung	Typ	Kolben- \varnothing [mm]	Hub [mm]	Positionserken- nung A	Dämpfung einstellbar PPV	
Doppelt- wirkend	Grundtyp						
		DNU einseitige Kolbenstange	32, 40, 50, 63, 80, 100	25, 40, 50, 80, 100, 125, 160, 200, 250, 300, 320, 400, 500	10 ... 2000	■	■
		DNU-...-S2 durchgehende Kolbenstange	32, 40, 50, 63, 80, 100	–	10 ... 2000	■	■
	Verdrehgesicherte Kolbenstange						
		DNUL einseitige Kolbenstange	32 40 50, 63 80, 100	– – – –	10 ... 300 10 ... 400 10 ... 500 10 ... 600	■	■

Normzylinder DNU/DNUL, DIN ISO 6431

FESTO

Lieferübersicht

Typ	Kolbenstange Edelstahl S3	warmfeste Dichtung max. 120 °C S6	hoher Korrosionsschutz S8
Grundtyp			
DNU einseitige Kolbenstange	■	■	■
DNU-...-S2 durchgehende Kolbenstange	-	■	-
Verdrehgesicherte Kolbenstange			
DNUL einseitige Kolbenstange	-	■	-

Normzylinder DNU/DNUL, DIN ISO 6431

Datenblatt

FESTO

Bestellangaben							
Ausführung	Hub [mm]	Kolben-Ø 32 [mm] Teile-Nr. Typ ¹⁾		Kolben-Ø 40 [mm] Teile-Nr. Typ ¹⁾		Kolben-Ø 50 [mm] Teile-Nr. Typ ¹⁾	
Grundtyp							
	25	14 121	DNU-32-25-PPV-A	14 132	DNU-40-25-PPV-A	14 143	DNU-50-25-PPV-A
	40	14 122	DNU-32-40-PPV-A	14 133	DNU-40-40-PPV-A	14 144	DNU-50-40-PPV-A
	50	14 123	DNU-32-50-PPV-A	14 134	DNU-40-50-PPV-A	14 145	DNU-50-50-PPV-A
	80	14 124	DNU-32-80-PPV-A	14 135	DNU-40-80-PPV-A	14 146	DNU-50-80-PPV-A
	100	14 125	DNU-32-100-PPV-A	14 136	DNU-40-100-PPV-A	14 147	DNU-50-100-PPV-A
	125	14 126	DNU-32-125-PPV-A	14 137	DNU-40-125-PPV-A	14 148	DNU-50-125-PPV-A
	160	14 127	DNU-32-160-PPV-A	14 138	DNU-40-160-PPV-A	14 149	DNU-50-160-PPV-A
	200	14 128	DNU-32-200-PPV-A	14 139	DNU-40-200-PPV-A	14 150	DNU-50-200-PPV-A
	250	14 129	DNU-32-250-PPV-A	14 140	DNU-40-250-PPV-A	14 151	DNU-50-250-PPV-A
	300	14 130	DNU-32-300-PPV-A	14 141	DNU-40-300-PPV-A	14 152	DNU-50-300-PPV-A
	320	34 704	DNU-32-320-PPV-A	34 705	DNU-40-320-PPV-A	34 706	DNU-50-320-PPV-A
	400	32 473	DNU-32-400-PPV-A	32 475	DNU-40-400-PPV-A	32 477	DNU-50-400-PPV-A
	500	32 474	DNU-32-500-PPV-A	32 476	DNU-40-500-PPV-A	32 478	DNU-50-500-PPV-A
	Variabler Hub	10 ... 2 000	14 120	DNU-32-...-PPV-A	14 131	DNU-40-...-PPV-A	14 142
Variante S2	10 ... 2 000	14 186	DNU-32-...-PPV-A-S2	14 187	DNU-40-...-PPV-A-S2	14 188	DNU-50-...-PPV-A-S2
Variante S3	10 ... 2 000	158 844	DNU-32-...-PPV-A-S3	158 845	DNU-40-...-PPV-A-S3	158 846	DNU-50-...-PPV-A-S3
Variante S6	10 ... 2 000	14 919	DNU-32-...-PPV-A-S6	14 920	DNU-40-...-PPV-A-S6	14 921	DNU-50-...-PPV-A-S6
Variante S8	10 ... 2 000	158 850	DNU-32-...-PPV-A-S8	158 851	DNU-40-...-PPV-A-S8	158 852	DNU-50-...-PPV-A-S8
Variante S26	10 ... 2 000	14 925	DNU-32-...-PPV-A-S26	14 926	DNU-40-...-PPV-A-S26	14 927	DNU-50-...-PPV-A-S26
mit verdrehgesicherter Kolbenstange							
Variabler Hub	10 ... 300	15 602	DNUL-32-...-PPV-A	–	–	–	–
	10 ... 400	–	–	15 603	DNUL-40-...-PPV-A	–	–
	10 ... 500	–	–	–	–	15 604	DNUL-50-...-PPV-A
	10 ... 600	–	–	–	–	–	–
Variante S6	10 ... 300	15 660	DNUL-32-...-PPV-A-S6	–	–	–	–
	10 ... 400	–	–	15 661	DNUL-40-...-PPV-A-S6	–	–
	10 ... 500	–	–	–	–	15 662	DNUL-50-...-PPV-A-S6
	10 ... 600	–	–	–	–	–	–

1) Im Lieferumfang ist eine Sechskantmutter für das Kolbenstangengewinde enthalten

Normzylinder DNU/DNUL, DIN ISO 6431

Datenblatt

FESTO

Bestellangaben							
Ausführung	Hub [mm]	Kolben-Ø 63 [mm] Teile-Nr. Typ ¹⁾		Kolben-Ø 80 [mm] Teile-Nr. Typ ¹⁾		Kolben-Ø 100 [mm] Teile-Nr. Typ ¹⁾	
Grundtyp							
	25	14 154	DNU-63-25-PPV-A	14 165	DNU-80-25-PPV-A	14 176	DNU-100-25-PPV-A
	40	14 155	DNU-63-40-PPV-A	14 166	DNU-80-40-PPV-A	14 177	DNU-100-40-PPV-A
	50	14 156	DNU-63-50-PPV-A	14 167	DNU-80-50-PPV-A	14 178	DNU-100-50-PPV-A
	80	14 157	DNU-63-80-PPV-A	14 168	DNU-80-80-PPV-A	14 179	DNU-100-80-PPV-A
	100	14 158	DNU-63-100-PPV-A	14 169	DNU-80-100-PPV-A	14 180	DNU-100-100-PPV-A
	125	14 159	DNU-63-125-PPV-A	14 170	DNU-80-125-PPV-A	14 181	DNU-100-125-PPV-A
	160	14 160	DNU-63-160-PPV-A	14 171	DNU-80-160-PPV-A	14 182	DNU-100-160-PPV-A
	200	14 161	DNU-63-200-PPV-A	14 172	DNU-80-200-PPV-A	14 183	DNU-100-200-PPV-A
	250	14 162	DNU-63-250-PPV-A	14 173	DNU-80-250-PPV-A	14 184	DNU-100-250-PPV-A
	300	14 163	DNU-63-300-PPV-A	14 174	DNU-80-300-PPV-A	14 185	DNU-100-300-PPV-A
	320	34 707	DNU-63-320-PPV-A	34 708	DNU-80-320-PPV-A	34 709	DNU-100-320-PPV-A
	400	32 479	DNU-63-400-PPV-A	32 481	DNU-80-400-PPV-A	32 483	DNU-100-400-PPV-A
500	32 480	DNU-63-500-PPV-A	32 482	DNU-80-500-PPV-A	32 484	DNU-100-500-PPV-A	
Variabler Hub	10 ... 2 000	14 153	DNU-63-...-PPV-A	14 164	DNU-80-...-PPV-A	14 175	DNU-100-...-PPV-A
Variante S2	10 ... 2 000	14 189	DNU-63-...-PPV-A-S2	14 190	DNU-80-...-PPV-A-S2	14 191	DNU-100-...-PPV-A-S2
Variante S3	10 ... 2 000	158 847	DNU-63-...-PPV-A-S3	158 848	DNU-80-...-PPV-A-S3	158 849	DNU-100-...-PPV-A-S3
Variante S6	10 ... 2 000	14 922	DNU-63-...-PPV-A-S6	14 923	DNU-80-...-PPV-A-S6	14 924	DNU-100-...-PPV-A-S6
Variante S8	10 ... 2 000	158 853	DNU-63-...-PPV-A-S8	158 854	DNU-80-...-PPV-A-S8	158 855	DNU-100-...-PPV-A-S8
Variante S26	10 ... 2 000	14 928	DNU-63-...-PPV-A-S26	14 929	DNU-80-...-PPV-A-S26	14 930	DNU-100-...-PPV-A-S26
mit verdrehgesicherter Kolbenstange							
Variabler Hub	10 ... 300	–	–	–	–	–	–
	10 ... 400	–	–	–	–	–	–
	10 ... 500	15 605	DNUL-63-...-PPV-A	–	–	–	–
	10 ... 600	–	–	15 606	DNUL-80-...-PPV-A	15 607	DNUL-100-...-PPV-A
Variante S6	10 ... 300	–	–	–	–	–	–
	10 ... 400	–	–	–	–	–	–
	10 ... 500	15 663	DNUL-63-...-PPV-A-S6	–	–	–	–
	10 ... 600	–	–	15 664	DNUL-80-...-PPV-A-S6	15 665	DNUL-100-...-PPV-A-S6

1) Im Lieferumfang ist eine Sechskantmutter für das Kolbenstangengewinde enthalten



Normzylinder DNU/DNUL, DIN ISO 6431

Zubehör

FESTO

Bestellangaben – Mehrstellungsbausatz DPNN			
	für Ø	Werkstoff	Teile-Nr. Typ
	32	Flansch: Alu-Knetlegierung;	13 468 DPNN-32
	40	Gewindestifte, Sechskantmutter: Stahl, verzinkt	13 469 DPNN-40
	50	Kupfer-, PTFE- und silikonfrei	13 470 DPNN-50
	63		13 471 DPNN-63
	80		13 472 DPNN-80
	100		13 473 DPNN-100

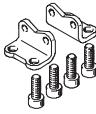
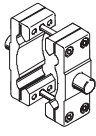
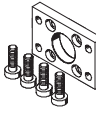
 Hinweis
Bei Kombination von Zylindern und Mehrstellungsbausatz darf die maximale Gesamthublänge nicht überschritten werden.



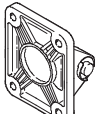

Bestellangaben				Bestellangaben			
Benennung	für Ø	Teile-Nr.	Typ	Benennung	für Ø	Teile-Nr.	Typ
Fußbefestigung HN				Schwenkzapfen-Bausatz ZNU			
	32	5 135	HN-32		32	14 210	ZNU-32
	40	5 136	HN-40		40	14 211	ZNU-40
	50	5 137	HN-50		50	14 212	ZNU-50
	63	5 138	HN-63		63	14 213	ZNU-63
	80	5 139	HN-80		80	14 214	ZNU-80
	100	5 140	HN-100		100	14 215	ZNU-100
Flanschbefestigung FN				Lagerstück LNZ			
	32	5 141	FN-32		32	6 184	LNZ-32
	40	5 142	FN-40		40/50	6 185	LNZ-40/50
	50	5 143	FN-50		63/80	6 186	LNZ-63/80
	63	5 144	FN-63		100	6 187	LNZ-100/125
	80	5 145	FN-80				
	100	5 146	FN-100				

Bestellangaben – Befestigungselemente			
Benennung	für Ø	Teile-Nr.	Typ
Schwenkflansch SN			
	32	5 153	SN-32
	40	5 154	SN-40
	50	5 155	SN-50
	63	5 156	SN-63
	80	5 157	SN-80
	100	5 158	SN-100

Normzylinder DNU/DNUL, DIN ISO 6431

Zubehör

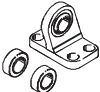
FESTO

Bestellangaben – Befestigungselemente				Datenblätter → 1 / 10.1-2			
Benennung	für Ø	Teile-Nr.	Typ	Benennung	für Ø	Teile-Nr.	Typ
Lagerbock LN				Lagerbock LNG			
	32	5 147	LN-32		32	33 890	LNG-32
	40	5 148	LN-40		40	33 891	LNG-40
	50	5 149	LN-50		50	33 892	LNG-50
	63	5 150	LN-63		63	33 893	LNG-63
	80	5 151	LN-80		80	33 894	LNG-80
	100	5 152	LN-100		100	33 895	LNG-100
Lagerbock LSN				Lagerbock LBG			
	32	5 561	LSN-32		32	31 761	LBG-32
	40	5 562	LSN-40		40	31 762	LBG-40
	50	5 563	LSN-50		63	31 764	LBG-63
	63	5 564	LSN-63		100	31 766	LBG-100
	80	5 565	LSN-80				
	100	5 566	LSN-100				

Bestellangaben – Drossel-Rückschlagventile				Datenblätter → Band 2				
	Anschluss		Werkstoff	Teile-Nr.	Typ			
	Gewinde	für Schlauch-Außen-Ø						
	G $\frac{1}{8}$	3	Metall-Ausführung	193 142	GRLA- $\frac{1}{8}$ -QS-3-D			
		4		193 143	GRLA- $\frac{1}{8}$ -QS-4-D			
		6		193 144	GRLA- $\frac{1}{8}$ -QS-6-D			
		8		193 145	GRLA- $\frac{1}{8}$ -QS-8-D			
	G $\frac{1}{4}$	6		193 146	GRLA- $\frac{1}{4}$ -QS-6-D			
		8		193 147	GRLA- $\frac{1}{4}$ -QS-8-D			
		10		193 148	GRLA- $\frac{1}{4}$ -QS-10-D			
		6		193 149	GRLA- $\frac{3}{8}$ -QS-6-D			
	G $\frac{3}{8}$	8		193 150	GRLA- $\frac{3}{8}$ -QS-8-D			
		10		193 151	GRLA- $\frac{3}{8}$ -QS-10-D			
		12		193 152	GRLA- $\frac{1}{2}$ -QS-12-D			

Normbasierte Zylinder
DIN ISO 6431

1.3

- 1 - Auslauftyp FEN-32...100

Lieferbar bis 2008





Normzylinder DNU/DNUL, DIN ISO 6431

Zubehör

FESTO

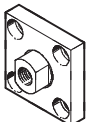
Normbasierte Zylinder
DIN ISO 6431

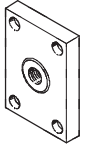
1.3

Bestellangaben – Kolbenstangenaufsätze				Datenblätter → 1 / 10.3-2			
Benennung	für Ø	Teile-Nr. Typ		Benennung	für Ø	Teile-Nr. Typ	
Gelenkkopf SGS				Kupplungsstück KSG			
	32	9 261	SGS-M10x1,25		32	32 963	KSG-M10x1,25
	40	9 262	SGS-M12x1,25		40	32 964	KSG-M12x1,25
	50	9 263	SGS-M16x1,5		50	32 965	KSG-M16x1,5
	63				63		
	80	9 264	SGS-M20x1,5		80	32 966	KSG-M20x1,5
	100				100		
Gabelkopf SGA				Kupplungsstück KSZ			
	32	32 954	SGA-M10x1,25		32	36 125	KSZ-M10x1,25
	40	10 767	SGA-M12x1,25		40	36 126	KSZ-M12x1,25
	50	10 768	SGA-M16x1,5		50	36 127	KSZ-M16x1,25
	63				63		
	80	10 769	SGA-M20x1,5		80	36 128	KSZ-M20x1,25
	100				100		
Gabelkopf SG				Flexo-Kupplung FK			
	32	6 144	SG-M10x1,25		32	6 140	FK-M10x1,25
	40	6 145	SG-M12x1,25		40	6 141	FK-M12x1,25
	50	6 146	SG-M16x1,5		50	6 142	FK-M16x1,5
	63				63		
	80	6 147	SG-M20x1,5		80	6 143	FK-M20x1,5
	100				100		

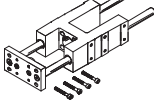
Bestellangaben – Führungseinheiten					Datenblätter → 1 / 10.4-2		
	für Ø [mm]	Hub [mm]	mit Kugelumlaufrührung		mit Gleitführung		
			Teile-Nr.	Typ	Teile-Nr.	Typ	
	32	10 ... 500	33 484	FEN-32-...-KF	19 171	FEN-32-...	
	40		33 485	FEN-40-...-KF	19 172	FEN-40-...	
	50		33 486	FEN-50-...-KF	19 173	FEN-50-...	
	63		33 487	FEN-63-...-KF	19 174	FEN-63-...	
	80		33 488	FEN-80-...-KF	19 175	FEN-80-...	
	100		33 489	FEN-100-...-KF	19 176	FEN-100-...	

Normzylinder DNU/DNUL, DIN ISO 6431

Zubehör



FESTO



Bestellangaben – Näherungsschalter in Quaderform, magnetoresistiv						Datenblätter → 1 / 10.2-84	
	Montage	Schalt- ausgang	Elektrischer Anschluss		Kabellänge [m]	Teile-Nr.	Typ
			Kabel	Stecker M8			
Schließer							
	mit Zubehör	PNP	3-adrig	–	2,5	151 683	SMT0-1-PS-K-LED-24-C
			–	3-polig	–	151 685	SMT0-1-PS-S-LED-24-C
		NPN	3-adrig	–	2,5	151 684	SMT0-1-NS-K-LED-24-C
			–	3-polig	–	151 686	SMT0-1-NS-S-LED-24-C

Bestellangaben – Näherungsschalter in Quaderform, magnetisch Reed						Datenblätter → 1 / 10.2-84	
	Montage	Elektrischer Anschluss		Kabellänge [m]	Teile-Nr.	Typ	
		Kabel	Stecker M8				
Schließer							
	mit Zubehör	3-adrig	–	2,5	30 459	SME0-1-LED-24-B	
		3-adrig	–	5,0	151 672	SME0-1-LED-24-K5-B	
		–	3-polig	–	150 848	SME0-1-S-LED-24-B	

Bestellangaben – Befestigungsbausatz für Näherungsschalter SME0/SMT0-1				Datenblätter → 1 / 10.2-101	
	für Ø	Montage		Teile-Nr.	Typ
	32 ... 50 mm	auf dem Zylinder-Profilrohr		36 173	SMBU-1-B
	63 ... 100 mm			36 174	SMBU-2-B

Bestellangaben – Näherungsschalter in Quaderform, pneumatisch				Datenblätter → 1 / 10.2-84	
	Montage	Pneumatischer Anschluss		Teile-Nr.	Typ
3/2-Wegeventil, Grundstellung geschlossen					
	mit Zubehör	Stecknippel für Schlauch-Innen-Ø 3 mm		31 008	SMPO-1-H-B

Bestellangaben – Befestigungsbausatz für Näherungsschalter SMPO-1				Datenblätter → 1 / 10.2-101	
	für Ø	Montage		Teile-Nr.	Typ
	32 mm	direkt auf dem Zylinder-Profilrohr		150 216	SMBU-1-H-32
	63 ... 100 mm			36 174	SMBU-2-B
	32 ... 100 mm	mit Spannband auf dem Zylinder-Profilrohr		151 226	SMBS-2

Bestellangaben – Steckdosenkabel						Datenblätter → 1 / 10.2-113	
	Montage	Schaltausgang		Anschluss	Kabellänge [m]	Teile-Nr.	Typ
		PNP	NPN				
Dose gerade							
	Überwurf- mutter M8	■	■	3-polig	2,5	159 420	SIM-M8-3GD-2,5-PU
					5	159 421	SIM-M8-3GD-5-PU
Dose gewinkelt							
	Überwurf- mutter M8	■	■	3-polig	2,5	159 422	SIM-M8-3WD-2,5-PU
					5	159 423	SIM-M8-3WD-5-PU