

- Three sizes MICRO, MINI, MIDI
- Flow rate of 45 ... 600 l/min
- Multi-pin plug connection via Sub-D or round plug
- Assembled and tested unit

Do not use for new designs!
-  - Type to be discontinued

FESTO

Valve terminal MICRO/MINI/MIDI-E

Key features

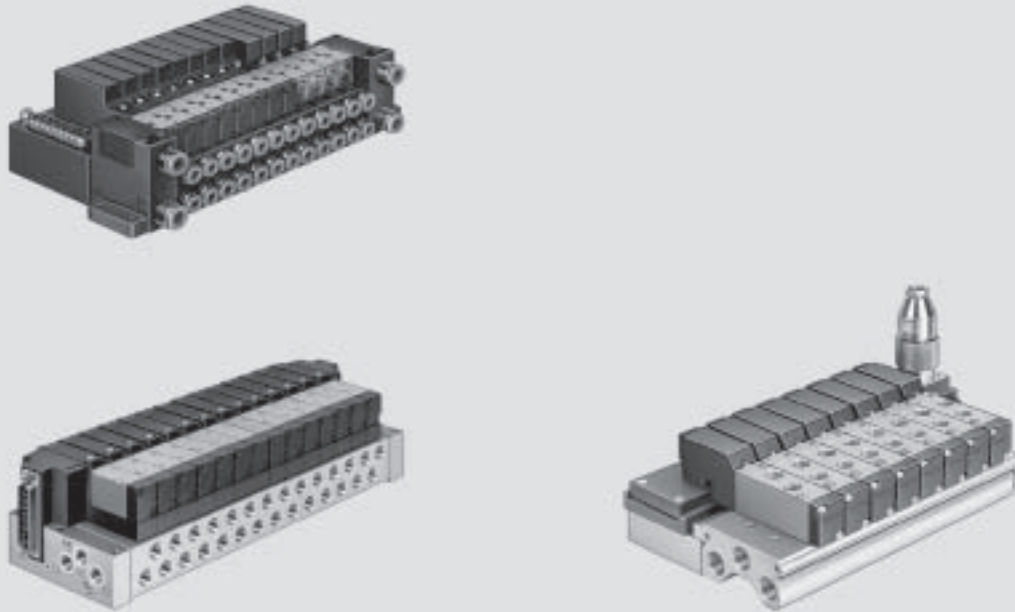

Valve terminal MICRO/MINI/MIDI-E

Small, compact and cost-effective:

-  Flow rate:
 - MICRO 45 ... 80 l/min
 - MINI 130 ... 190 l/min
 - MIDI 500 l/min
-  Valve width
 - MICRO 10 mm
 - MINI 16 mm
 - MIDI 18 mm

Connection sizes:

- MICRO: Push-in connector for 4 mm tubing
- MINI: Thread G1/8
- MIDI: Thread G1/4

Quality

For years, Festo valve terminals have been a symbol of success in the field of intelligent pneumatics. The MICRO, MINI and MIDI-E series complete the performance spectrum with small sizes, and extremely compact valve terminals which have proven their worth again and again all over the world.

Do not use for new designs!

- 1 - Type to be discontinued

Valve terminal MICRO/MINI/MIDI-E

Key features

Valve terminals with multi-pin plug connection

The success of these valve terminals results from their small, compact, cost-effective design, as well as high speed response times. The valve terminals are supplied fully checked and only need to be attached with 4 bolts and they're ready to go.

- Valve terminals can be equipped with 4 to 16 valve positions in accordance with customer requirements.
- MICRO: Can be expanded in steps of 4
- MINI, MIDI-E: Can be expanded in steps of 2
- Protection class IP40
- Supplied fully assembled
- Fast switching times
- Low power consumption
- LED display and integrated protective circuit for each solenoid

Valve functions with MICRO, MINI and MIDI-E:

- Monostable and bistable valves
- 5/3-way valves with MINI series
- 3/2-way valves with MIDI-E series

Easy tubing installation:

The manifold includes a common supply port and ducted exhaust for all valves.

- Optional blanking plates for vacant positions
- Can be controlled via multi-pin plug (PNP), or alternatively NPN as well for the MINI series
- One or two plugs depending on the number of valve positions
- Manual override and LEDs for status display for each individual valve for quick and easy commissioning

Instructions for use

Equipment

Operate your equipment with unlubricated compressed air if possible. Festo valves and cylinders are designed for operation under normal use without any additional lubrication, yet still have a long service life. The quality of compressed air downstream from the compressor must correspond to that of unlubricated compressed air. If possible, do not operate all of your equipment with lubricated compressed air. The lubricators should, where possible, always be installed directly upstream of the actuators used.

Incorrect additional oil and too high an oil content in the compressed air reduces the service life of the valve terminal.
Use Festo special oil OFSW-32 or the alternatives listed in the Festo catalogue (as specified in DIN 51 524-HLP32; basic oil viscosity 32 CST at 40 °C).

Bio-oils

When using bio-oils (oils which are based upon synthetic or native ester, e.g. rapeseed oil methyl ester), the maximum residual oil content of 0.1 mg/m³ must not be exceeded (see ISO 8573-1 Class 2).

Mineral oils

When using mineral oils (e.g. HLP oils to DIN 51 524, parts 1 through 3) or similar oils based on poly-alpha-olefins (PAO), the maximum residual oil content of 5 mg/m³ must not be exceeded (see ISO 8573-1 Class 4)
A higher residual oil content irrespective of the compressor oil cannot be permitted, as the basic lubricant would be washed away over time.

Welding environment

Valve terminal MICRO/MINI/MIDI-E has a high-quality metal/plastic design.

Suitable covers should be used to prevent the terminal being damaged as a result of welding spatter.

- 1 - Type to be discontinued
Available up to December 2004

FESTO

Valve terminal MICRO

Technical data – Valve terminal MICRO

-  - Flow rate
45 l/min (MZH-...)
80 l/min (JMZH-...)

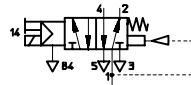

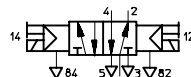

MZH-5/2-1,5-LED-VI

-  - Voltage
24 V DC



JMZH-5/2-1,5-LED-VI

-  - Pressure
2 ... 7 bar (MZH-...)
0 ... 8 bar (JMZH-...)

-  - Temperature range
+5 ... +50 °C

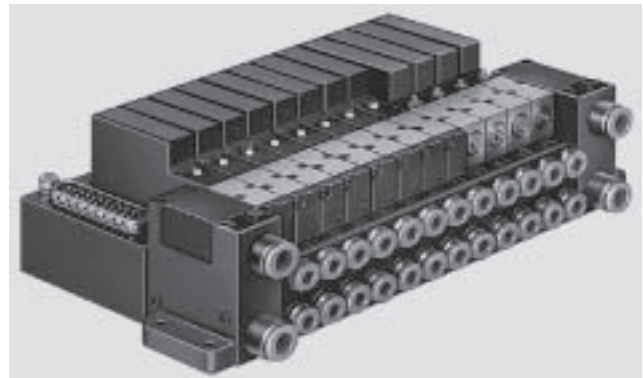

Application-optimised valve terminals
MICRO / MINI / MID-E

3.3

General technical data – Type MICRO

Valve function	5/2-way valve	
	Single solenoid valve	Double solenoid
	MZH-5/2-1,5-LED-VI	JMZH-5/2-1,5-LED-VI
Constructional design	Indirectly actuated piston spool valve	Directly actuated poppet valve
Nominal size [mm]	1.5	
Type of mounting	Through-holes on manifold	
Mounting position	Any	
Connection, valve terminal	1, 3/5: Push-in connector for 6 mm tubing	
Connection, valve	4, 2: Push-in connector for 4 mm tubing	
Manual override	None	
Electrical connection	Multi-pin plug (Sub-D) or prefabricated cable, PNP	
Protection class to EN 60 529	IP40	
Power consumption per valve solenoid [W]	0.55	2.0

Valve response times [ms]

	MZH-5/2-1,5-LED-VI	JMZH-5/2-1,5-LED-VI
Response times	On	9
	Off	25

Ambient conditions

Operating medium	Filtered compressed air, lubricated or unlubricated → 4 / 3.3-3
Grade of filtration [µm]	5
Ambient temperature [°C]	+5 ... +50
Temperature of medium [°C]	+5 ... +50
Corrosion resistance class CRC ¹⁾	2

1) CRC2: Corrosion resistance class to Festo standard 940 070
Components requiring moderate corrosion resistance. Externally visible parts with primarily decorative surface requirements which are in direct contact with a surrounding industrial atmosphere or media such as cooling or lubricating agents.

-  - Type to be discontinued
Available up to December 2005

FESTO

Valve terminal MINI

Technical data – Valve terminal MINI

-  - Flow rate
190 l/min (5/2)
130 l/min (5/3)

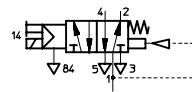

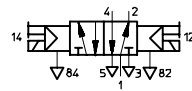

MYH-5/2-2,3-LED

-  - Voltage
24 V DC



JMYH-5/2-2,3-LED

-  - Pressure
2 ... 7 bar

-  - Temperature range
+5 ... +50 °C

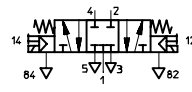

MYH-5/3G-2,3-LED

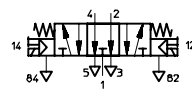

MYH-5/3E-2,3-LED

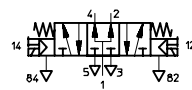

MYH-5/3B-2,3-LED

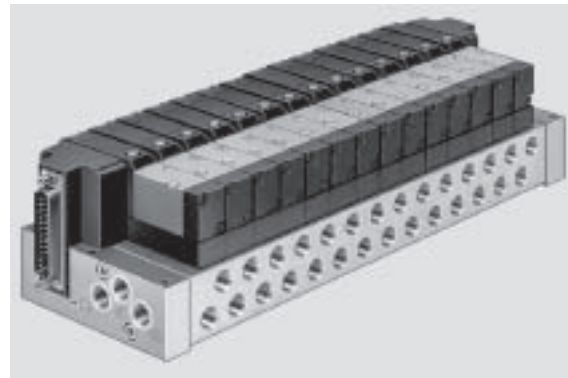

Application-optimised valve terminals
MICRO / MINI / MIDE

3.3

General technical data – Type MINI					
Valve function	5/2-way valve		5/3-way valve		
	Single solenoid valve	Double solenoid	Mid-position valve, closed	Mid-position valve, exhausted	Mid-position valve, pressurised
	MYH-5/2-2,3-LED	JMYH-5/2-2,3-LED	MYH-5/3G-2,3-LED	MYH-5/3E-2,3-LED	MYH-5/3B-2,3-LED
Constructional design	Indirectly actuated piston spool valve				
Nominal size [mm]	2.3				
Type of mounting	Through-holes on manifold				
Mounting position	Any				
Connection, valve terminal	1, 3/5: G $\frac{1}{8}$				
Connection, valve	4, 2: G $\frac{1}{8}$				
Manual override	None				
Electrical connection	Multi-pin plug (Sub-D) or prefabricated cable, PNP or NPN				
Protection class to EN 60 529	IP40				
Power consumption per valve solenoid [W]	0.55				

Valve response times [ms]						
		MYH-5/2-2,3-LED	JMYH-5/2-2,3-LED	MYH-5/3G-2,3-LED	MYH-5/3E-2,3-LED	MYH-5/3B-2,3-LED
Response times	On	20	15	20	20	20
	Off	40	-	45	45	45

Ambient conditions	
Operating medium	Filtered compressed air, lubricated or unlubricated → 4 / 3.3-3
Grade of filtration [µm]	5
Ambient temperature [°C]	+5 ... +50
Temperature of medium [°C]	+5 ... +50
Corrosion resistance class CRC ¹⁾	2

1) CRC2: Corrosion resistance class to Festo standard 940 070

Components requiring moderate corrosion resistance. Externally visible parts with primarily decorative surface requirements which are in direct contact with a surrounding industrial atmosphere or media such as cooling or lubricating agents.

- 1 - Type to be discontinued
Available up to December 2005

FESTO

Valve terminal MIDI-E

Technical data – Valve terminal MIDI-E

-  Flow rate
600 l/min

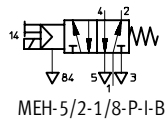

-  Voltage
24 V DC

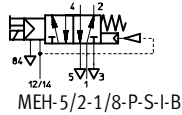

-  Pressure
2.5 ... 8 bar
(MEH-5/2-1/8-P-I-B)
-0.9 ... 10 bar
(MEH-5/2-P-S-I-B)
2 ... 8 bar (MEH-3/2-P-I-B)

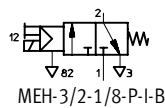

-  Temperature range
-5 ... +50 °C

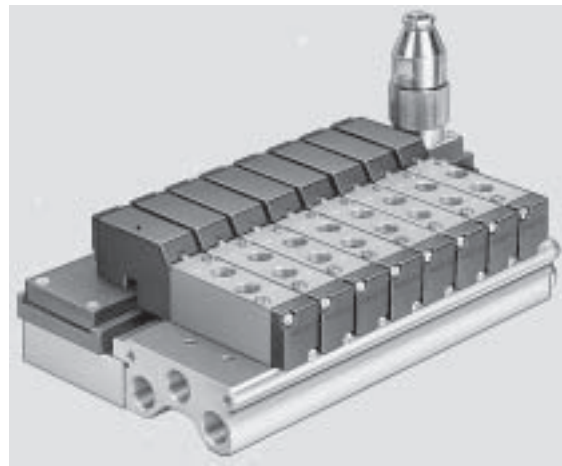
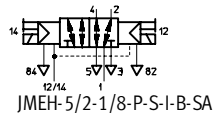
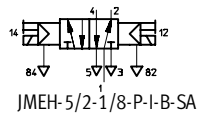

Application-optimised valve terminals
MICRO / MINI / MIDI-E

3.3

General technical data – Type MINI

Valve function	5/2-way valve				3/2-way valve
	Single solenoid valve	Single solenoid valve	Double solenoid valve	Double solenoid valve, with pilot air	Single solenoid valve
	MEH-5/2-1/8-P-I-B	MEH-5/2-1/8-P-S-I-B	JMEH-5/2-1/8-P-I-B-SA	JMEH-5/2-1/8-P-S-I-B-SA	MEH-3/2-1/8-P-I-B
Constructional design	Cartridge piston spool valve				
Nominal size [mm]	2.3				
Type of mounting	Through-holes on manifold				
Mounting position	Any				
Connection, valve terminal	1, 3/5: G $\frac{1}{4}$; 82/84: M5				
Connection, valve	4, 2: G $\frac{1}{8}$				
Manual override	None				
Electrical connection	Multi-pin plug (round plug) or prefabricated cable				
Protection class to EN 60 529	IP 54				
Power consumption per valve solenoid [W]	0.95				

Valve response times [ms]

		MEH-5/2-1/8-P-I-B	MEH-5/2-1/8-P-S-I-B	MEH-3/2-1/8-P-I-B
Response times	On	10	15	10
	Off	28	28	28

Ambient conditions

Operating medium	Filtered compressed air, lubricated or unlubricated → 4 / 3.3-3
Grade of filtration [μm]	40
Ambient temperature [°C]	-5 ... +50
Temperature of medium [°C]	-5 ... +50
Corrosion resistance class CRC ¹⁾	2

1) CRC2: Corrosion resistance class to Festo standard 940 070

Components requiring moderate corrosion resistance. Externally visible parts with primarily decorative surface requirements which are in direct contact with a surrounding industrial atmosphere or media such as cooling or lubricating agents.

- 1 - Type to be discontinued
Available up to December 2004

FESTO

Valve terminal VIMP-MICRO – Multi-pin

Ordering data – Modular products

M Mandatory data →

Module No.	Valve terminal	Series	Connection	Connection size	Number of valve positions
18 971	VIMP	MICRO	QS	4	4 8 12 16
Order example					
18 971	VIMP	- MICRO	- QS	- 4	- 8
1	2	3	4	5	6

Ordering table						Condi- tions	Code	Enter code
M	1	Module No.	18 971					
	2	Valve terminal	Valve terminal with multi-pin connection				VIMP	VIMP
	3	Series	MICRO series				-MICRO	-MICRO
	4	Connection	QS connection				-QS	-QS
	5	Connection size	Size 4				-4	-4
↓	6	Number of valve positions	4	8	12	16	-...	

Application-optimised valve terminals
MICRO / MINI / MID-E

3.3

Transfer order code

18 971	VIMP	- MICRO	- QS	- 4	-
1	2	3	4	5	6

- 1 - Type to be discontinued
Available up to December 2004



Valve terminal VIMP-MICRO – Multi-pin

Ordering data – Modular products

M Mandatory data																O Options
Equipping of valve terminal																Electrical accessories
M, J, A																N, P, Q, R, S, T
Valve positions																
1	2	3	4	5	6	7	8	9	10	11	12	13	14	15	16	
-	M	M	J	J	J	M	M	A								+ Q
7																8

Ordering table							
Module No.	18 971			Condi- tions	Code	Enter code	
M 7	Equipping of valve terminal				-	-	Enter equip- ment selec- tion for valve positions in order code
		5/2-way valve, single solenoid				M	
		5/2-way valve, double solenoid				J	
		Blanking plate for vacant position Pneumatic and electrical				A	
O	Accessories				+	+	
8	Electrical accessories	Connecting cable with plug, for valve terminals with 4 valve positions, length 2.5 m (9-pin)				N	
		Connecting cable with plug, for valve terminals with 4 valve positions, length 5 m (9-pin)				P	
		Connecting cable with plug, for valve terminals with 8/12 valve positions, length 2.5 m (25-pin)				Q	
		Connecting cable with plug, for valve terminals with 8/12 valve positions, length 5 m (25-pin)				R	
		2 connecting cables with plug, for valve terminals with 16 valve positions, length 2.5 m				S	
		2 connecting cables with plug, for valve terminals with 16 valve positions, length 5 m				T	

Transfer order code

1	2	3	4	5	6	7	8	9	10	11	12	13	14	15	16	
-																+ []
7																8

- 1 - Type to be discontinued
Available up to December 2005

Valve terminal VIMP-MINI – Multi-pin

FESTO

Ordering data – Modular products

[M] Mandatory data →

Module No.	Valve terminal	Series	Connection size	Number of valve positions
18 981 18 991	VIMP	MINI	1/8	4 6 8 10 12 14 16
Order example				
18 981	VIMP	- MINI	- 1/8	- 6
1	2	3	4	5

Ordering table

		Condi- tions	Code	Enter code						
[M]	1 Module No.	18 981 PNP version 18 991 NPN version								
	2 Valve terminal	Valve terminal with multi-pin connection		VIMP						
	3 Series	MINI series		-MINI						
	4 Connection size	G1/8		-1/8						
↓	5 Number of valve positions	4	6	8	10	12	14	16	-...	

Application-optimised valve terminals
 MICRO / MINI / MIDE

3.3

Transfer order code

18 981	VIMP	- MINI	- 1/8	
1	2	3	4	5

- 1 - Type to be discontinued
Available up to December 2005



Valve terminal VIMP-MINI – Multi-pin

Ordering data – Modular products

[M] Mandatory data																[0] Options	
Equipping of valve terminal																Pneumatic accessories	Electrical accessories
M, J, G, E, B, A																U, V	N, P, Q, R
Valve positions																	
1	2	3	4	5	6	7	8	9	10	11	12	13	14	15	16		
-	M	M	G	B	M	J										+ U	P
																7	

Ordering table						
Module No.		18 981 18 991	Condi- tions	Code	Enter code	
↓ [M] 6	Equipping of valve terminal			-	-	
		5/2-way valve, single solenoid		M	Enter equip- ment selec- tion for valve positions in order code	
		5/2-way valve, double solenoid		J		
		5/3-way valve, mid-position closed		G		
		5/3-way valve, mid-position exhausted		E		
		5/3-way valve, mid-position pressurised		B		
		Blanking plate for vacant position		A		
[0] 7	Accessories			+		+
	Pneumatic accessories	Silencer kit, up to 6 valves		U		
		Silencer kit, for more than 6 valves		V		
	Electrical accessories	Connecting cable with plug, for valve terminals with up to 10 valve positions, length 2.5 m			N	
		Connecting cable with plug, for valve terminals with up to 10 valve positions, length 5 m			P	
		2 connecting cables with plug, for valve terminals with 12/16 valve positions, length 2.5 m			Q	
		2 connecting cables with plug, for valve terminals with 12/16 valve positions, length 5 m			R	

Transfer order code

1	2	3	4	5	6	7	8	9	10	11	12	13	14	15	16		
-																+ []	[]
																6	7

Application-optimised valve terminals
MICRO / MINI / MIDE

3.3

- 1 - Type to be discontinued
Available up to December 2005



Valve terminal VIMP1-MIDI – Multi-pin

Ordering data – Modular products

[M] Mandatory data →

Module No.	Valve terminal	Connection size	Series	Number of valve positions
152 320	VIMP1	E	MIDI	6 8 10 12
Order example				
152 320	VIMP1	E	MIDI	8
1	2	3	4	5

Ordering table

				Condi- tions	Code	Enter code
[M]	1	Module No.	152 320			
	2	Valve terminal	Valve terminal with multi-pin connection		VIMP1	VIMP1
	3	Connection size	Size E		-E	-E
	4	Series	MIDI series		-MIDI	-MIDI
↓	5	Number of valve positions	6 8 10 12		-...	

Application-optimised valve terminals
MICRO / MINI / MIDI-E

3.3

Transfer order code

152 320	VIMP1	E	MIDI	
1	2	3	4	5

- 1 - Type to be discontinued
Available up to December 2005

FESTO

Valve terminal VIMP1-MIDI – Multi-pin

Ordering data – Modular products

M Mandatory data												
Equipping of valve terminal												
M, S, N, J, K, A												
Valve positions												
1	2	3	4	5	6	7	8	9	10	11	12	
- M	M	S	N	M	N	K	A					
6												

O Options	
Electrical accessories	Pneumatic accessories
V, X, N, P, Q, R, S, T, Y, Z	U
V	
7	

Ordering table					
Module No.		Condi- tions	Code	Enter code	
M 6	Equipping of valve terminal		-	-	
	5/2-way valve, single solenoid		M	Enter equip- ment selec- tion for valve positions in order code	
	5/2-way valve, single solenoid, auxiliary pilot air		S		
	3/2-way valve, single solenoid, normally open		N		
	5/2-way valve, double solenoid		J		
	5/2-way valve, double solenoid, auxiliary pilot air		K		
	Blanking plate for vacant position		A		
Pneumatic and electrical					
O 7	Accessories		+	+	
	Electrical accessories	Multi-pin plug socket, straight, 12-pin, for valve terminals with up to 10 valve positions		V	
		Multi-pin plug socket, straight, 16-pin, for valve terminals with 12 valve positions			
		Multi-pin plug socket, angled, 12-pin, for valve terminals with up to 10 valve positions		X	
		Multi-pin plug socket, angled, 16-pin, for valve terminals with 12 valve positions			
		Connecting cable, straight, for valve terminals with up to 10 valve positions, length 2.5 m		N	
		Connecting cable, straight, for valve terminals with up to 10 valve positions, length 5 m		P	
		Connecting cable, straight, for valve terminals with 12 valve positions, length 2.5 m		Q	
		Connecting cable, straight, for valve terminals with 12 valve positions, length 5 m		R	
		Connecting cable, angled, for valve terminals with up to 10 valve positions, length 2.5 m		S	
		Connecting cable, angled, for valve terminals with up to 10 valve positions, length 5 m		T	
		Connecting cable, angled, for valve terminals with 12 valve positions, length 2.5 m		Y	
Connecting cable, angled, for valve terminals with 12 valve positions, length 5 m		Z			
Pneumatic accessories	Silencer kit, connection G $\frac{1}{4}$:		U		

Transfer order code

1	2	3	4	5	6	7	8	9	10	11	12	
-												
6												7

Application-optimised valve terminals
MICRO / MINI / MIDI-E

3.3