



- Electrically or pneumatically actuated valves

- With internal or external pilot air

- Sturdy and reliable

Specified types in accordance with ATEX directive for potentially explosive atmospheres

→ www.festo.com/en/ex

Solenoid/pneumatic valves, Tiger 2000

Key features



General information

- A complete and comprehensive range with 5/2- and 5/3-way valves
- Poppet valve for single solenoid functions or piston spool for more complex versions with air spring, and 5/3-way valves
- Optimised for increased flow rates without increasing size
- Tubing connection threads in sizes G $\frac{1}{8}$, G $\frac{1}{4}$, G $\frac{3}{8}$
- Diverse and flexible, side and front mounting
- Pneumatic or electrical actuation
- Versatile electrical connection with F or V solenoid coil with minimal power consumption, can also be used with valve terminals
- Functional and timeless design, enclosed front housing

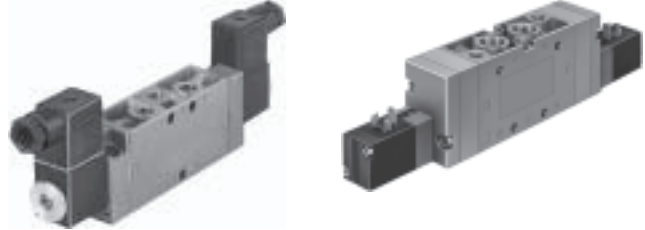

Solenoid coils

F solenoid coils

Voltage:

- 12 to 230 V DC
- 12 to 240 V AC (50 to 60 Hz)

Power consumption:

- 4.5 W

- For all MFH valves
- Selected types conform to the ATEX directive for explosive atmospheres
→ www.festo.com/en/ex

- Easily interchangeable solenoid coils
- Solenoid coil not included in scope of delivery

V solenoid coils

Voltage:

- 24 V DC

Power consumption:

- 2.5 W

- For all MVH valves
- Minimal heat-up

- Solenoid coil included in scope of delivery

Manifold mounting

With PAL manifold strip



With PRS manifold



The Tiger 2000 valves can be mounted on PAL manifold strips with common supply port or on PRS manifolds with common supply port and common exhausts. Manifold strips and manifolds have 2 to 10 valve positions.

Solenoid/pneumatic valves, Tiger 2000

Key features



Valve terminals

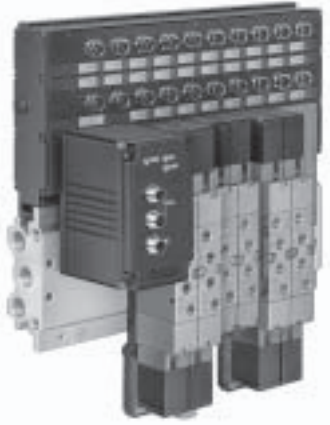

Ready to connect, completely assembled type 02 valve terminal, available with Tiger 2000 valves (V solenoid).

Connection options:

- Central multi-pin plug
- Fieldbus interface for all common fieldbus protocols
- Autonomous with integrated controller (PLC)
- For G $\frac{1}{8}$ and G $\frac{1}{4}$

Manual override for valves with V solenoid coil

Resetting (standard)



Press on the aluminium plate

Conversion to detenting actuation

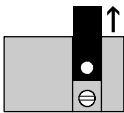

1 Pull out the aluminium plate

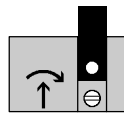

2 Using a screwdriver, simultaneously push and turn the exposed manual override

Blocking the manual override

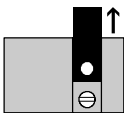

1 Pull out the aluminium plate

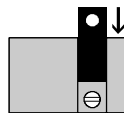

2 Rotate the aluminium plate by 180° and replace



3 The manual override is now blocked

Pilot exhaust air for valves with V solenoid coil

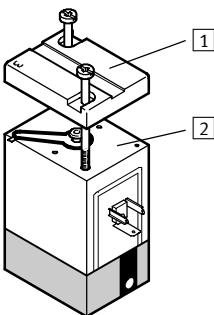

- 1 The cap may not be turned when removing the seal
- 2 Seal installed

Free pilot exhaust air
Unducted by removing the seal in the top cover, the 3 on the cap must always be aligned with valve port 84 or 82.

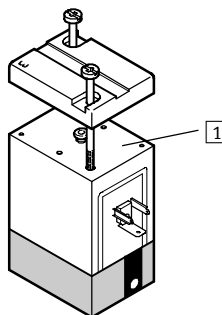

- 1 Seal removed

Solenoid valves, Tiger 2000

Product range overview



Directional control valves for standard applications
Tiger 2000

2.2

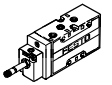
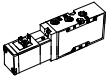
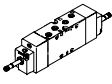
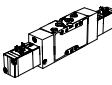
Function	Version	Type	Pneumatic connection	Operating voltage		Pilot air supply		Type of reset		→ Page
				[V DC]	[V AC]	Internal	External	Pneumatic spring	Mechanical spring	
5/2-way valves	Solenoid valve									
		MFH	G $\frac{1}{8}$	12, 24, 42,	24, 42, 48,	■	■	■	■	2 / 2.2-11
			G $\frac{1}{4}$	48	110, 230,	■	■	■	■	
			G $\frac{3}{8}$		240	■	■	■	■	
		MVH	G $\frac{1}{8}$	24	–	■	■	■	■	2 / 2.2-29
			G $\frac{1}{4}$			■	■	■	■	
			G $\frac{3}{8}$			■	■	■	■	
	Double solenoid valve									
		JMFH	G $\frac{1}{8}$	12, 24, 42,	24, 42, 48,	■	■	–	–	2 / 2.2-18
			G $\frac{1}{4}$	48	110, 230,	■	■	–	–	
G $\frac{3}{8}$				240	■	■	–	–		
	JMVH	G $\frac{1}{8}$	24	–	■	■	–	–	2 / 2.2-35	
		G $\frac{1}{4}$			■	■	–	–		
		G $\frac{3}{8}$			■	■	–	–		

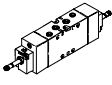
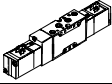
Function	Version	Type	Pneumatic connection	Operating voltage		Pilot air supply		Normal position			→ Page
				[V DC]	[V AC]	Internal	External	Closed	Exhausted	Pressurised	
5/3-way valves	Solenoid valve										
		MFH-5/3	G $\frac{1}{8}$	12, 24,	24, 42,	■	■	■	■	■	2 / 2.2-23
			G $\frac{1}{4}$	42, 48	48, 110,	■	■	■	■	■	
			G $\frac{3}{8}$		230, 240	■	■	■	■	■	
		MVH-5/3	G $\frac{1}{8}$	24	–	■	■	■	■	■	2 / 2.2-41
			G $\frac{1}{4}$			■	■	■	■	■	
G $\frac{3}{8}$					■	■	■	■	■		

Pneumatic valves, Tiger 2000

Product range overview

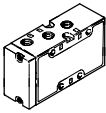
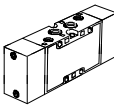

Function	Version	Type	Pneumatic connection	Type of reset		→ Page
				Pneumatic spring	Mechanical spring	
5/2-way valves	Pneumatic valve					
		VL	G1/8	-	■	2 / 2.2-49
			G1/4	-	■	
			G3/8	-	■	
	Double pilot valve					
		J	G1/8	-	-	2 / 2.2-53
G1/4			-	-		
G3/8			-	-		

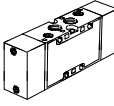
Function	Version	Type	Pneumatic connection	Normal position			→ Page
				Closed	Exhausted	Pressurised	
5/3-way valves	Pneumatic valve						
		VL	G1/8	■	■	■	2 / 2.2-56
			G1/4	■	■	■	
			G3/8	■	■	■	

Directional control valves for standard applications
Tiger 2000

2.2

Solenoid valves, Tiger 2000

Peripherals overview



Mounting on manifold

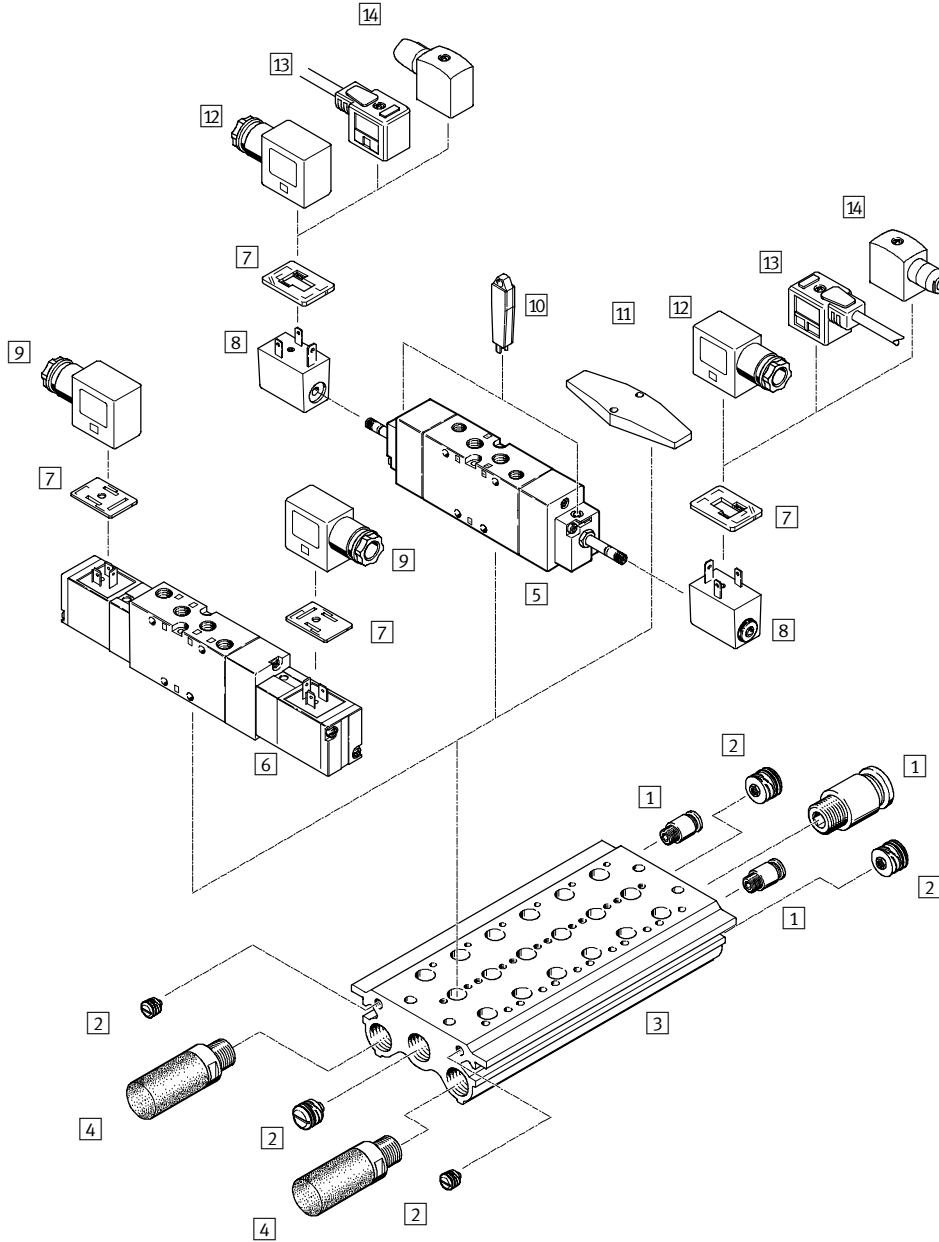

Variants

MFH-5-...-B

MVH-5-...-B

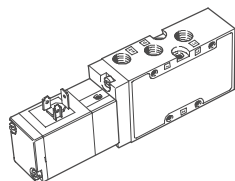
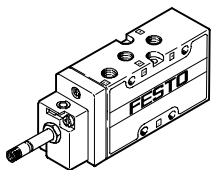

Solenoid valves, Tiger 2000

Peripherals overview



Accessories		
	Brief description	→ Page
1	Push-in fitting QS	Volume 3
2	Sealing plug PRSV	2 / 2.2-64
3	Manifold PRS	2 / 2.2-62
4	Silencer	Volume 3
5	Solenoid valve MFH	2 / 2.2-4
6	Solenoid valve MVH	2 / 2.2-4
7	Illuminating seal M...-LD	2 / 2.2-67
8	F solenoid coil MSFG, MSFW	2 / 2.2-66
9	Plug socket MSSD-V	2 / 2.2-67
10	Manual override tool AHB	2 / 2.2-65
11	Blanking plate PRSB	2 / 2.2-64
12	Plug socket MSSD-F	2 / 2.2-67
13	Plug socket cable KMF	2 / 2.2-67
14	Plug socket MSSD-F-S	2 / 2.2-67

Directional control valves for standard applications
Tiger 2000

2.2

Solenoid valves, Tiger 2000

Peripherals overview



Mounting on manifold strip

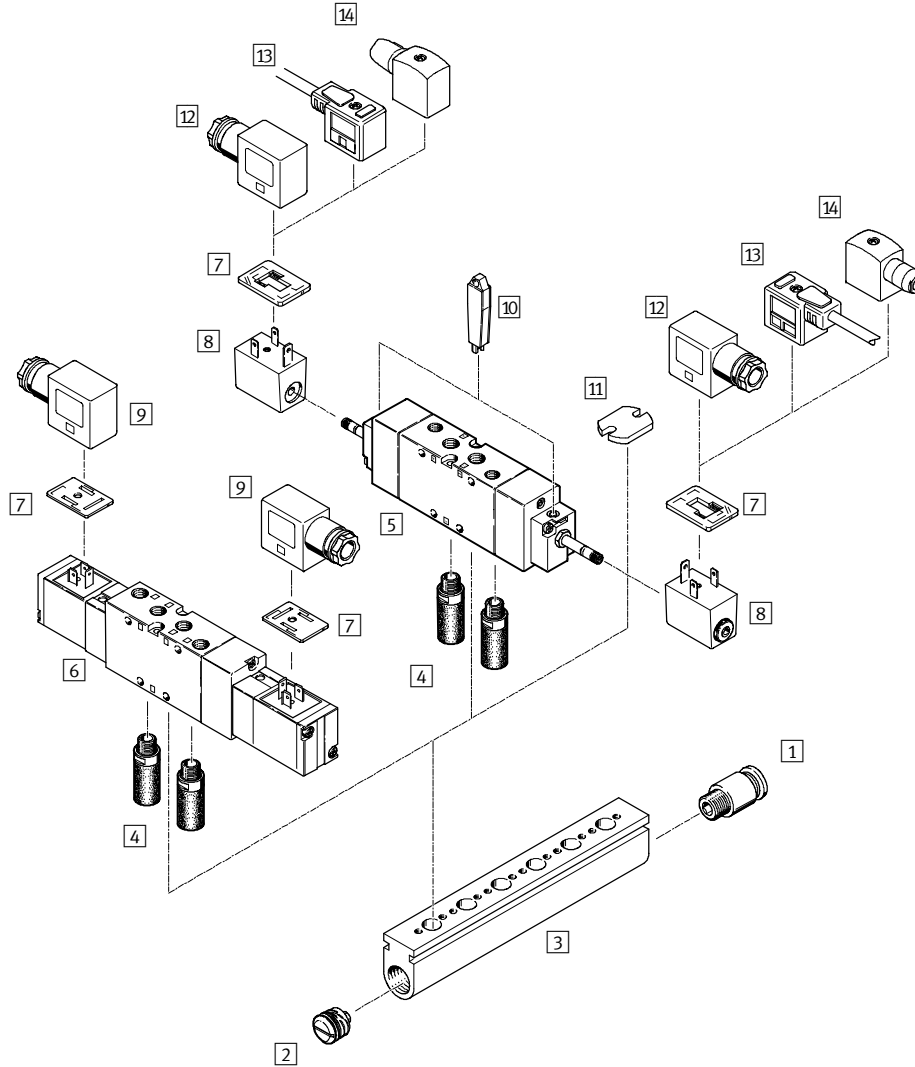

Variants

MFH-5-...-B

MVH-5-...-B

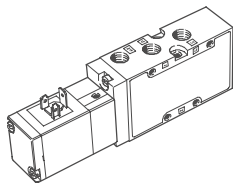
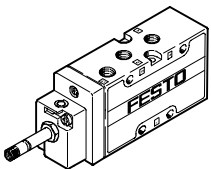

Solenoid valves, Tiger 2000

Peripherals overview

Accessories		
	Brief description	→ Page
1	Push-in fitting QS	Volume 3
2	Sealing plug PRSV	2 / 2.2-64
3	Manifold strip PAL	2 / 2.2-60
4	Silencer	Volume 3
5	Solenoid valve MFH	2 / 2.2-4
6	Solenoid valve MVH	2 / 2.2-4
7	Illuminating seal M...-LD	2 / 2.2-67
8	F solenoid coil MSFG, MSFW	2 / 2.2-66
9	Plug socket MSSD-V	2 / 2.2-67
10	Manual override tool AHB	2 / 2.2-65
11	Blanking plate PALB	2 / 2.2-64
12	Plug socket MSSD-F	2 / 2.2-67
13	Plug socket cable KMF	2 / 2.2-67
14	Plug socket MSSD-F-S	2 / 2.2-67

Solenoid valves, Tiger 2000

Type code

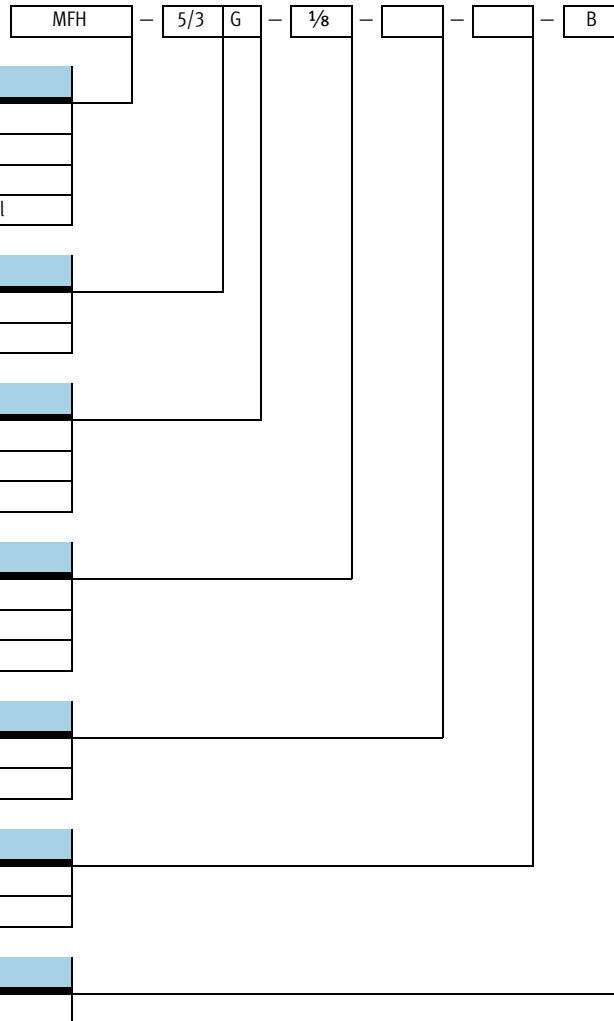

Solenoid valves MFH-B, Tiger 2000

Technical data – 5/2-way valves



-  - Flow rate
750 ... 2000 l/min

-  - Voltage
12, 24, 42, 48 V DC
24, 42, 48, 110, 230,
240 V AC
Wearing parts kits
→ 2 / 2.2-16



General technical data						
Pneumatic connection	G $\frac{1}{8}$		G $\frac{1}{4}$		G $\frac{3}{8}$	
Type of reset	Mechanical	Pneumatic	Mechanical	Pneumatic	Mechanical	Pneumatic
Valve function	5/2-way, single solenoid					
Constructional design	Poppet	Piston spool	Poppet	Piston spool		
Sealing principle	Soft					
Actuation type	Electrical					
Type of pilot control	Piloted					
Pilot air supply	Internal or external					
Direction of flow	Non-reversible	Reversible	Non-reversible	Reversible		
Exhaust function	With flow control					
Manual override	Via accessory, detenting					
Type of mounting	Via through-holes					
Mounting position	Any					
Nominal size	[mm]	5	8	7	10	12
Standard nominal flow rate	[l/min]	750	1000	1300	1600	2000
Grid dimension	[mm]	27		33		41
Product weight	[g]	220	280	300	380	630

Operating and environmental conditions							
Pneumatic connection	G $\frac{1}{8}$		G $\frac{1}{4}$		G $\frac{3}{8}$		
Type of reset	Pneumatic	Mechanical	Pneumatic	Mechanical	Pneumatic	Mechanical	
Operating medium	Filtered compressed air, lubricated or unlubricated Vacuum						
Operating pressure	Internal pilot air supply	[bar]	3 ... 10	2 ... 10	3 ... 10	2 ... 10	2 ... 10
	External pilot air supply	[bar]	-0.9 ... +10	0 ... 10	-0.9 ... +10	0 ... 10	-0.9 ... +10
Pilot pressure	[bar]	3 ... 10	2 ... 10	3 ... 10	1.5 ... 10	2 ... 10	2 ... 10
Ambient temperature	[°C]	-5 ... +40					
Temperature of medium	[°C]	-10 ... +60					

Solenoid valves MFH-B, Tiger 2000

Technical data – 5/2-way valves



Minimum pilot pressure p_{12} , p_{14} as a function of the operating pressure p_1 (external pilot air supply)

MFH-5-1/8-S-B

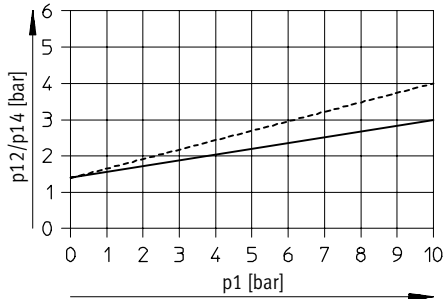

----- Exhaust throttled
 ————— Exhaust unthrottled

MFH-5-1/4-S-B

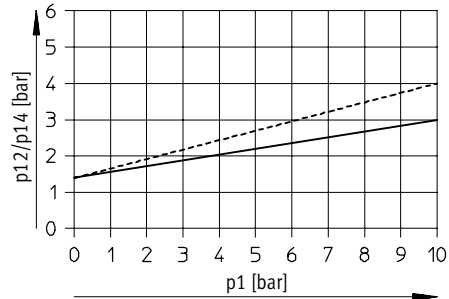

----- Exhaust throttled
 ————— Exhaust unthrottled

MFH-5-3/8-S-B

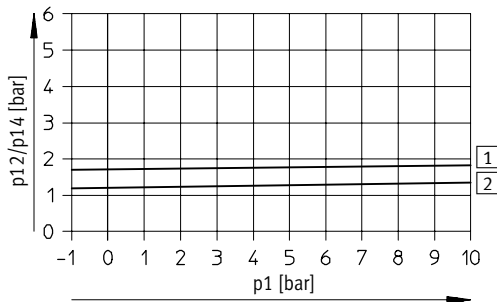

1 On
 2 Off

Valve response times [ms]

Pneumatic connection	G $\frac{1}{8}$		G $\frac{1}{4}$		G $\frac{3}{8}$	
Type of reset	Pneumatic	Mechanical	Pneumatic	Mechanical	Pneumatic	Mechanical
On	10	10	25	12	28	20
Off	30	30	44	36	55	56

Solenoid valves MFH-B, Tiger 2000

Technical data – 5/2-way valves



Electrical data			
F solenoid coil			
Electrical connection	Plug vanes for plug sockets MSSD-F, KMF		
Operating voltage	D.C. voltage	[V DC]	12, 24, 42, 48
	A.C. voltage	[V AC]	24, 42, 48, 110, 230, 240 (50 ... 60 Hz)
Coil characteristics	D.C. voltage	[W]	4.5
	A.C. voltage	[VA]	Pull: 7.5 Hold: 6
Protection class to EN 60 529	IP65 (in combination with plug socket)		

Materials

Sectional view

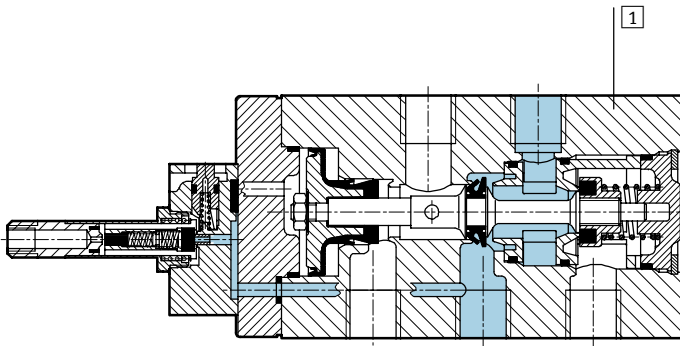

1	Housing	Die-cast aluminium
-	Seals	Nitrile rubber

Solenoid valves MFH-B, Tiger 2000

Technical data – 5/2-way valves



Directional control valves for standard applications
Tiger 2000

2.2

Dimensions – Pneumatic connection G $\frac{1}{8}$, G $\frac{1}{4}$

Download CAD data → www.festo.com/en/engineering

Basic valve

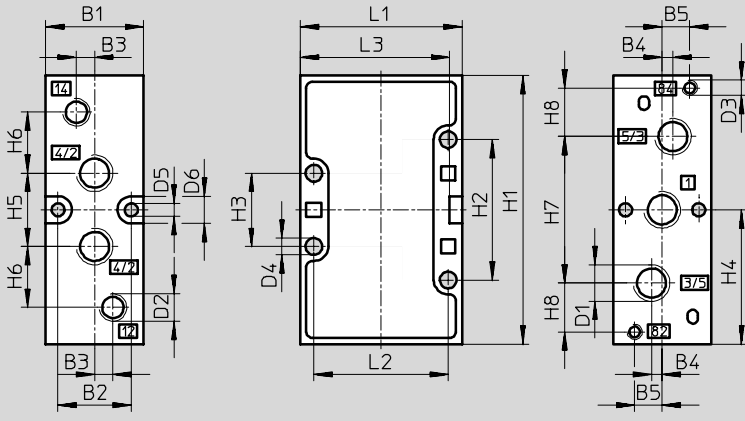

Installation dimensions with F solenoid coil

Mechanical reset

Pneumatic reset

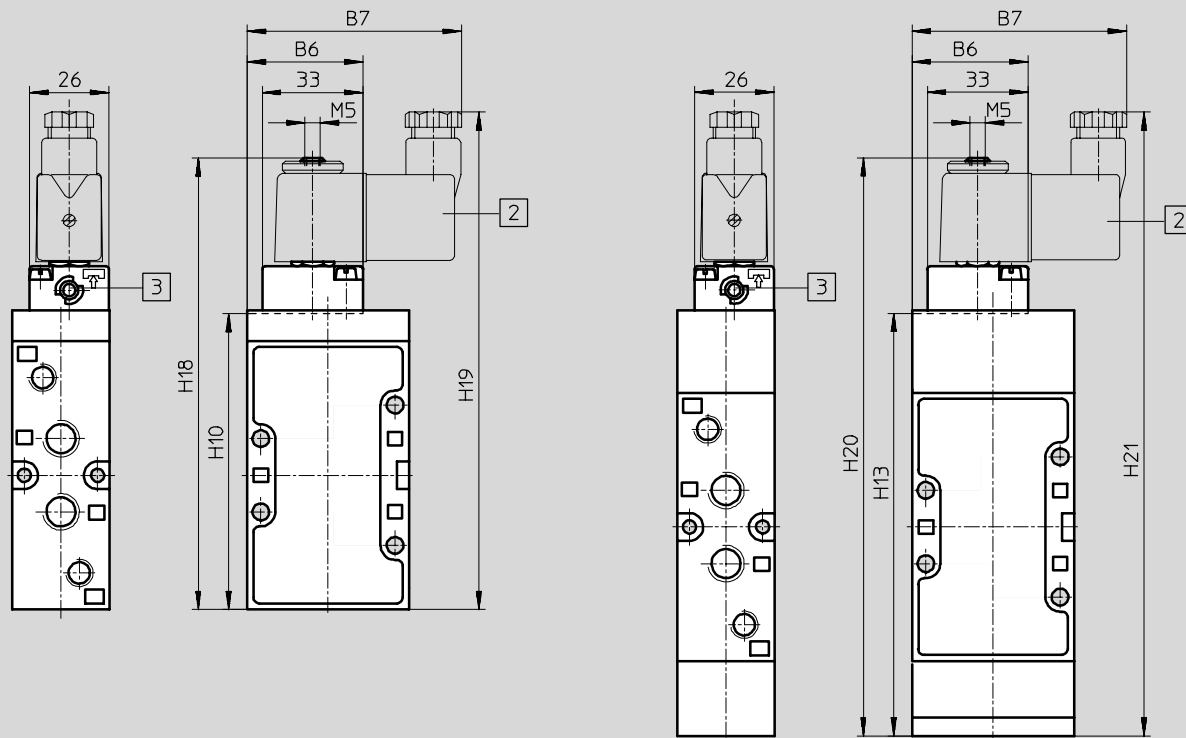

2 Solenoid coil is 360° rotatable

3 Manual override can be repositioned by 180°

Pneumatic connection	B1	B2	B3	B4	B5	B6	B7	D1	D2	D3	D4	D5	D6	H1	H2
G $\frac{1}{8}$	26	19.5	5	3.5	8	36.8	67	G $\frac{1}{8}$	G $\frac{1}{8}$	M5	4.5	4.3	9	77	41
G $\frac{1}{4}$	32	24	6	3.5	9	38	70	G $\frac{1}{4}$	G $\frac{1}{8}$	M5	5.5	4.3	9	88	46

Pneumatic connection	H3	H4	H5	H6	H7	H8	H10	H13	H18	H19	H20	H21	L1	L2	L3
G $\frac{1}{8}$	21	38.5	22	19	42	12	86.5	126.2	136	152	175	192	47	40	43
G $\frac{1}{4}$	24	44	24	20	48	16	97.5	139	147	163	188	205	53	44	79

Solenoid valves MFH-B, Tiger 2000

Technical data – 5/2-way valves



Dimensions – Pneumatic connection G $\frac{3}{8}$

Download CAD data → www.festo.com/en/engineering

Basic valve

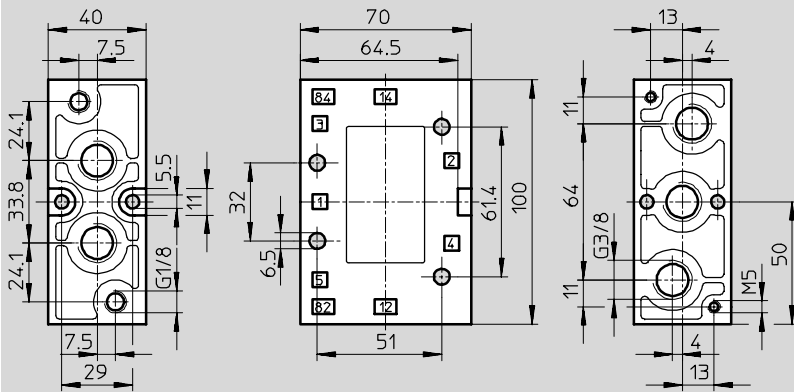

Installation dimensions with F solenoid coil

Mechanical or pneumatic reset

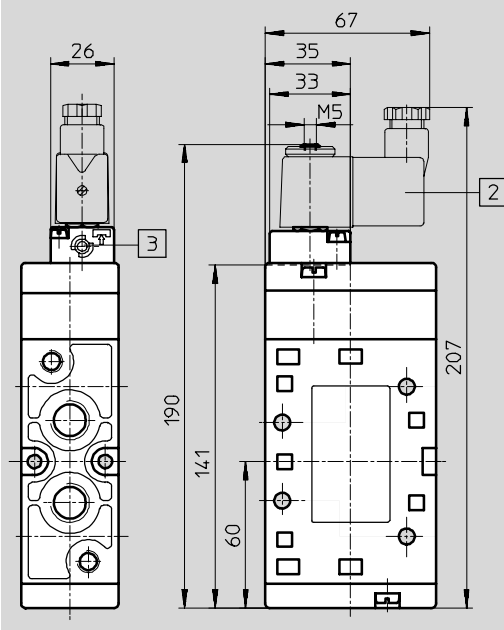

- 2 Solenoid coil is 360° rotatable
- 3 Manual override can be repositioned by 180°

Directional control valves for standard applications
Tiger 2000

2.2

Solenoid valves MFH-B, Tiger 2000

Technical data – 5/2-way valves



Directional control valves for standard applications
Tiger 2000

2.2

Ordering data				
Circuit symbol	Description	Pneumatic connection	Part No.	Type
	Without F solenoid coil ¹⁾ , pneumatic reset, internal pilot air supply	G $\frac{1}{8}$	30 991	MFH-5-1/8-L-B
		G $\frac{1}{4}$	31 010	MFH-5-1/4-L-B
		G $\frac{3}{8}$	14 946	MFH-5-3/8-L-B
	Without F solenoid coil ¹⁾ , pneumatic reset, external pilot air supply	G $\frac{1}{8}$	30 992	MFH-5-1/8-L-S-B
		G $\frac{1}{4}$	33 185	MFH-5-1/4-L-S-B
		G $\frac{3}{8}$	33 181	MFH-5-3/8-L-S-B
	Without F solenoid coil ¹⁾ , mechanical reset, internal pilot air supply	G $\frac{1}{8}$	19 758	MFH-5-1/8-B
		G $\frac{1}{4}$	15 901	MFH-5-1/4-B
		G $\frac{3}{8}$	19 705	MFH-5-3/8-B
	Without F solenoid coil ¹⁾ , mechanical reset, external pilot air supply	G $\frac{1}{8}$	19 759	MFH-5-1/8-S-B
		G $\frac{1}{4}$	15 902	MFH-5-1/4-S-B
	Without F solenoid coil ¹⁾ , mechanical reset, external pilot air supply	G $\frac{3}{8}$	19 706	MFH-5-3/8-S-B

1) F solenoid coils → 2 / 2.2-66

Ordering data – Wearing parts kits		
Pneumatic connection	Part No.	Type
G $\frac{1}{8}$	125 710	MFH-5-1/8-B
G $\frac{1}{4}$	115 580	MFH-5-1/4-B
G $\frac{3}{8}$	115 074	MFH-5-3/8-B

Solenoid valves JMFH-B, Tiger 2000

Technical data – 5/2-way valves, double solenoid



-  - Flow rate
1000 ... 2000 l/min

-  - Voltage
12, 24, 42, 48 V DC
24, 42, 48, 110, 230,
240 V AC

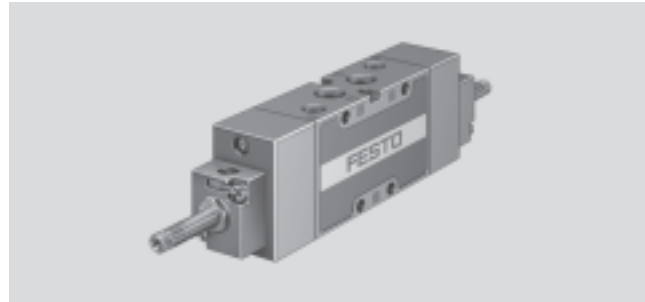

General technical data			
Pneumatic connection	G $\frac{1}{8}$	G $\frac{1}{4}$	G $\frac{3}{8}$
Valve function	5/2-way, double solenoid		
Constructional design	Piston spool		
Sealing principle	Soft		
Actuation type	Electrical		
Type of pilot control	Piloted		
Pilot air supply	Internal or external		
Direction of flow	Non-reversible		
Exhaust function	With flow control		
Manual override	Via accessory, detenting		
Type of mounting	Via through-holes		
Mounting position	Any		
Nominal size	[mm] 8	10	12
Standard nominal flow rate	[l/min] 1000	1600	2000
Grid dimension	[mm] 27	33	41
Product weight	[g] 400	460	650

Operating and environmental conditions				
Pneumatic connection		G $\frac{1}{8}$	G $\frac{1}{4}$	G $\frac{3}{8}$
Operating medium		Filtered compressed air, lubricated or unlubricated Vacuum		
Operating pressure	Internal pilot air supply	[bar] 2 ... 10		
	External pilot air supply	[bar] -0.9 ... +10		
Pilot pressure		[bar] 2 ... 10		
Ambient temperature		[°C] -5 ... +40		
Temperature of medium		[°C] -10 ... +60		

Directional control valves for standard applications
Tiger 2000

2.2

Solenoid valves JMFH-B, Tiger 2000

Technical data – 5/2-way valves, double solenoid



Minimum pilot pressure p_{12}/p_{14} as a function of the operating pressure p_1 (external pilot air supply)

JMFH-5-1/8-S-B

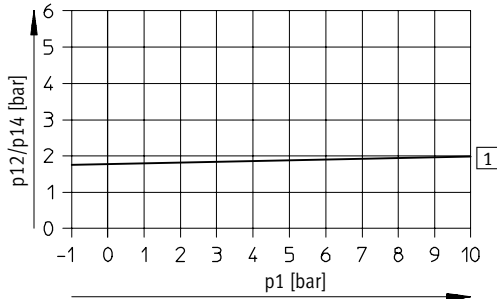

1 On

JMFH-5-1/4-S-B

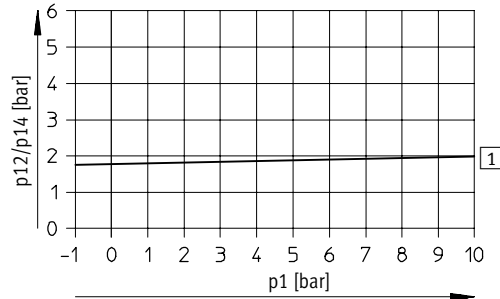

1 On

JMFH-5-3/8-S-B

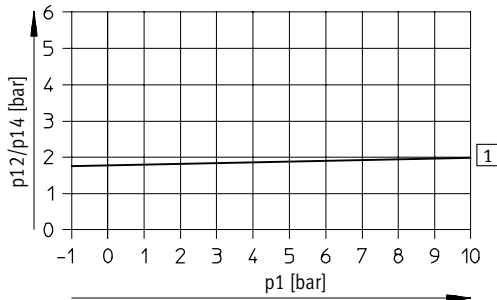

1 On

Valve response times [ms]

Pneumatic connection	G1/8	G1/4	G3/8
Changeover	12	14	12

Electrical data

F solenoid coil			
Electrical connection	Plug vanes for plug sockets MSSD-F, KMF		
Operating voltage	D.C. voltage	[V DC]	12, 24, 42, 48
	A.C. voltage	[V AC]	24, 42, 48, 110, 230, 240 (50 ... 60 Hz)
Coil characteristics	D.C. voltage	[W]	4.5
	A.C. voltage	[VA]	Pull: 7.5 Hold: 6
Protection class to EN 60 529	IP65 (in combination with plug socket)		

Solenoid valves JMFH-B, Tiger 2000

Technical data – 5/2-way valves, double solenoid



Materials

Sectional view

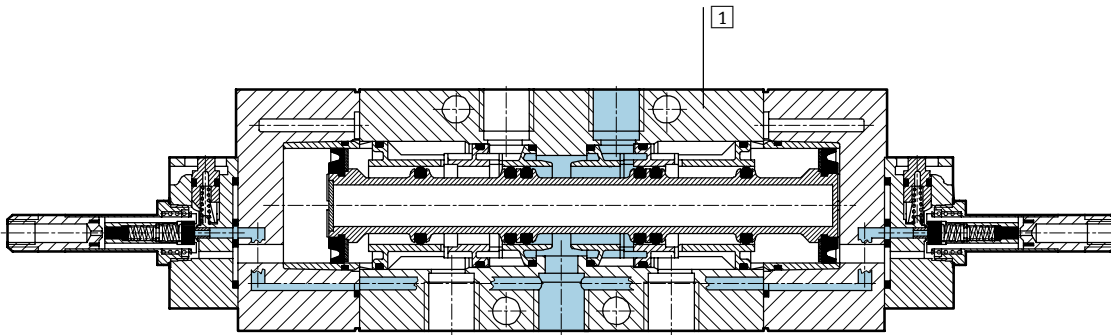

1	Housing	Die-cast aluminium
-	Seals	Nitrile rubber

Solenoid valves JMFH-B, Tiger 2000

Technical data – 5/2-way valves, double solenoid



Dimensions – Pneumatic connection G $\frac{1}{8}$, G $\frac{1}{4}$

Download CAD data → www.festo.com/en/engineering

Basic valve

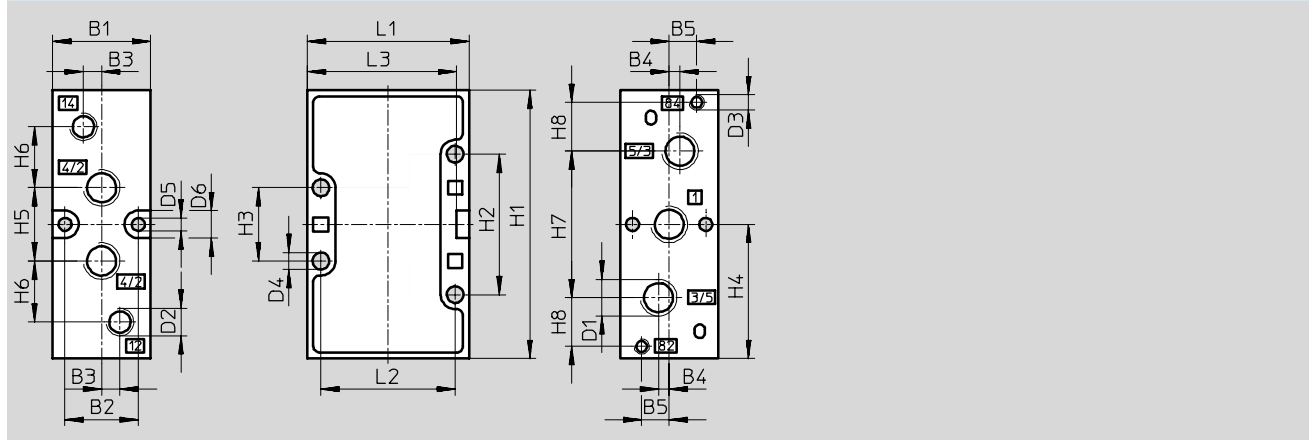

Installation dimensions with F solenoid coil, mechanical or pneumatic reset

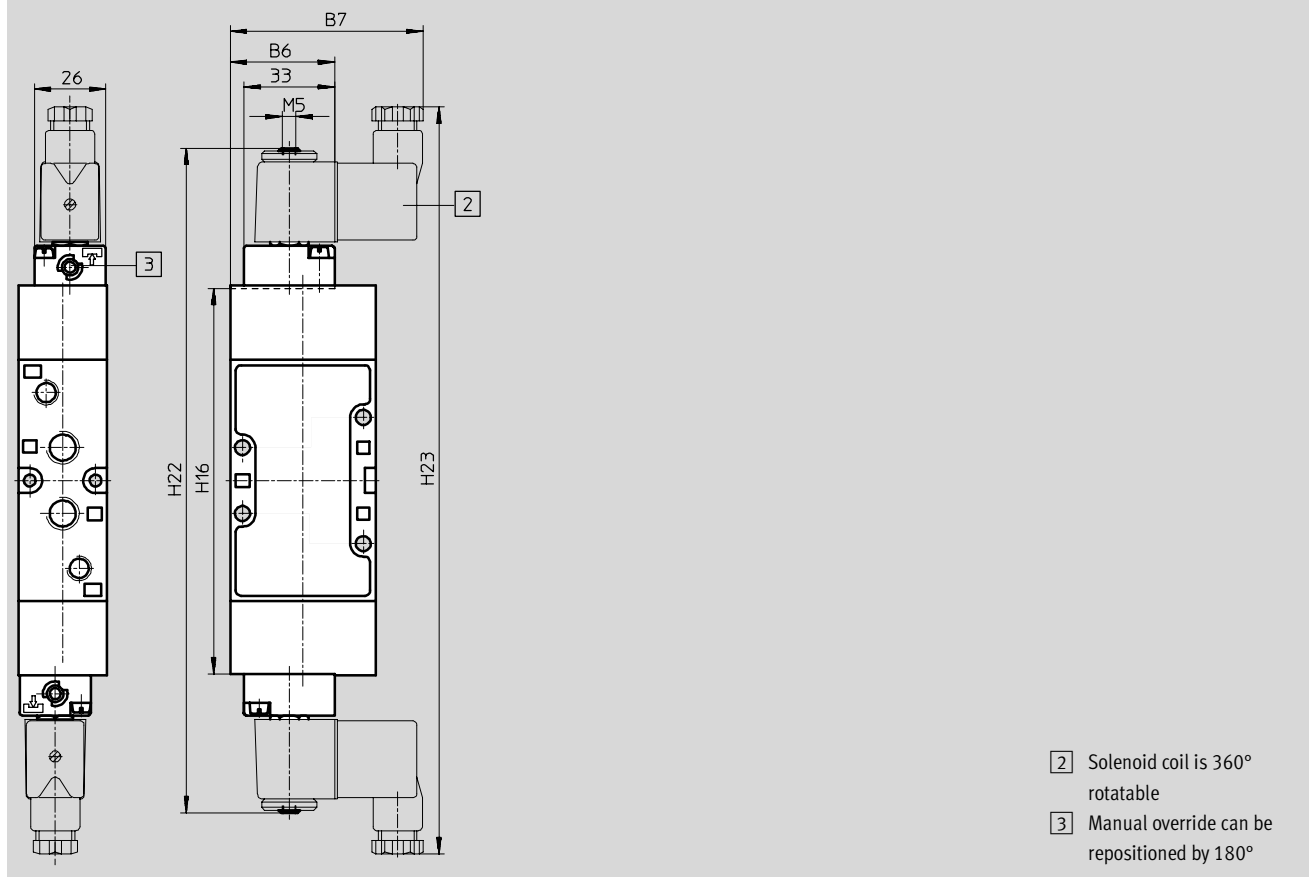

Pneumatic connection	B1	B2	B3	B4	B5	B6	B7	D1	D2	D3	D4	D5	D6	H1
G $\frac{1}{8}$	26	19.5	5	3.5	8	36.8	67	G $\frac{1}{8}$	G $\frac{1}{8}$	M5	4.5	4.3	9	77
G $\frac{1}{4}$	32	24	6	3.5	9	38	70	G $\frac{1}{4}$	G $\frac{1}{8}$	M5	5.5	4.3	9	88

Pneumatic connection	H2	H3	H4	H5	H6	H7	H8	H16	H22	H23	L1	L2	L3
G $\frac{1}{8}$	41	21	38.5	22	19	42	12	129	227	260	47	40	43
G $\frac{1}{4}$	46	24	44	24	20	48	16	141.5	240	273	53	44	79

Solenoid valves JMFH-B, Tiger 2000

Technical data – 5/2-way valves, double solenoid



Dimensions – Pneumatic connection G $\frac{3}{8}$

Download CAD data → www.festo.com/en/engineering

Basic valve

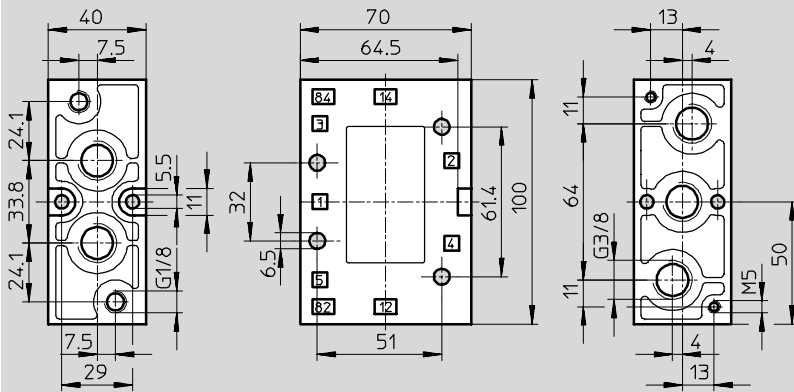

Installation dimensions with F solenoid coil, mechanical or pneumatic reset

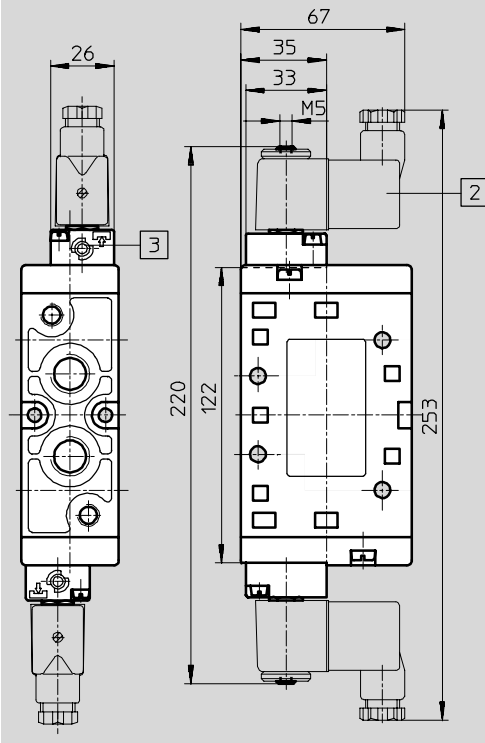

- 2 Solenoid coil is 360° rotatable
- 3 Manual override can be repositioned by 180°

Directional control valves for standard applications
Tiger 2000

2.2

Solenoid valves JMFH-B, Tiger 2000

Technical data – 5/2-way valves, double solenoid



Directional control valves for standard applications
Tiger 2000



Ordering data				
Circuit symbol	Description	Pneumatic connection	Part No.	Type
	Without F solenoid coil ¹⁾ , internal pilot air supply	G $\frac{1}{8}$	30 486	JMFH-5-$\frac{1}{8}$-B
		G $\frac{1}{4}$	19 789	JMFH-5-$\frac{1}{4}$-B
		G $\frac{3}{8}$	19 700	JMFH-5-$\frac{3}{8}$-B
	Without F solenoid coil ¹⁾ , external pilot air supply	G $\frac{1}{8}$	30 487	JMFH-5-$\frac{1}{8}$-S-B
		G $\frac{1}{4}$	19 790	JMFH-5-$\frac{1}{4}$-S-B
		G $\frac{3}{8}$	19 702	JMFH-5-$\frac{3}{8}$-S-B

1) F solenoid coils → 2 / 2.2-66

Solenoid valves MFH-B, Tiger 2000

Technical data – 5/3-way valves



-  - Flow rate
1000 ... 2600 l/min
-  - Voltage
12, 24, 42, 48 V DC
24, 42, 48, 110, 230,
240 V AC

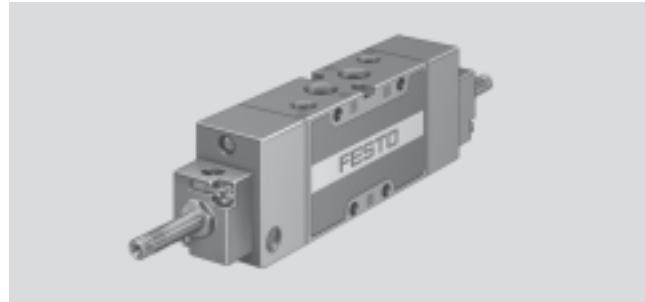

General technical data				
Pneumatic connection		G1/8	G1/4	G3/8
Valve function		5/3-way, single solenoid		
Constructional design		Piston spool		
Sealing principle		Soft		
Actuation type		Electrical		
Type of reset		Mechanical spring		
Type of pilot control		Piloted		
Pilot air supply		Internal or external		
Direction of flow		Non-reversible		
Exhaust function		With flow control		
Manual override		Via accessory, detenting		
Type of mounting		Via through-holes		
Mounting position		Any		
Nominal size		[mm] 5	7	12
Standard nominal flow rate	Closed	[l/min] 1000	1600	2000
	Exhausted	[l/min]		2200
	Pressurised	[l/min]		2600
Grid dimension		[mm] 27	33	41
Product weight		[g] 400	500	780

Operating and environmental conditions				
Pneumatic connection		G1/8	G1/4	G3/8
Operating medium		Filtered compressed air, lubricated or unlubricated Vacuum		
Operating pressure	Internal pilot air supply	[bar] 3 ... 10	3 ... 10	3 ... 10
	External pilot air supply	[bar] -0.9 ... +10	-0.9 ... +10	-0.9 ... +10
Pilot pressure		[bar] 3 ... 10	3 ... 10	3 ... 10
Ambient temperature		[°C] -5 ... +40		
Temperature of medium		[°C] -10 ... +60		

Solenoid valves MFH-B, Tiger 2000

Technical data – 5/3-way valves



Directional control valves for standard applications
Tiger 2000

2.2

Minimum pilot pressure p_{12}/p_{14} as a function of the operating pressure p_1 (external pilot air supply)

MFH-5/3...-1/8-S-B

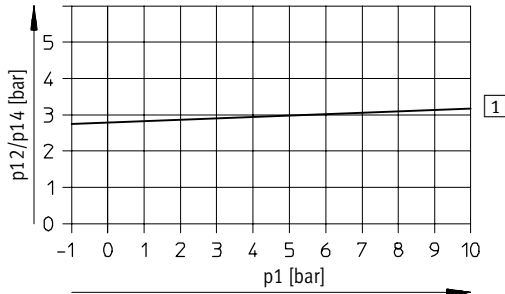

1 On

MFH-5/3...-1/4-S-B

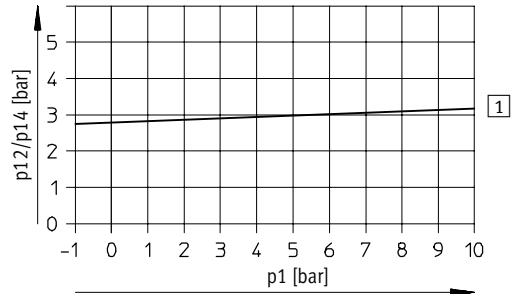

1 On

MFH-5/3...-3/8-S-B

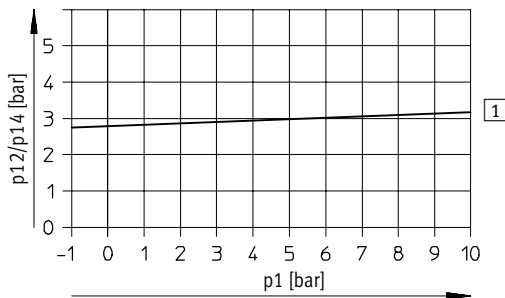

1 On

Valve response times [ms]

Pneumatic connection	G $\frac{1}{8}$		G $\frac{1}{4}$		G $\frac{3}{8}$	
	On	Off	On	Off	On	Off
Closed	18	20	20	22	24	80
Exhausted	20	20	24	36	36	85
Pressurised	24	24	34	30	30	82

Solenoid valves MFH-B, Tiger 2000

Technical data – 5/3-way valves



Electrical data			
F solenoid coil			
Electrical connection		Plug vanes for plug sockets MSSD-F, KMF	
Operating voltage	D.C. voltage	[V DC]	12, 24, 42, 48
	A.C. voltage	[V AC]	24, 42, 48, 110, 230, 240 (50 ... 60 Hz)
Coil characteristics	D.C. voltage	[W]	4.5
	A.C. voltage	[VA]	Pull: 7.5 Hold: 6
Protection class to EN 60 529		IP65 (in combination with plug socket)	

Materials

Sectional view

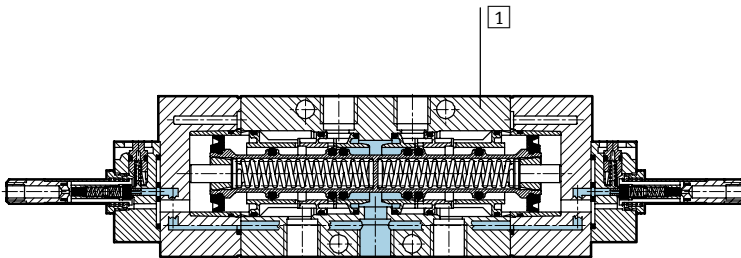

1	Housing	Die-cast aluminium
-	Seals	Nitrile rubber

Solenoid valves MFH-B, Tiger 2000

Technical data – 5/3-way valves



Directional control valves for standard applications
Tiger 2000

2.2

Dimensions – Pneumatic connection G $\frac{1}{8}$, G $\frac{1}{4}$

Download CAD data → www.festo.com/en/engineering

Basic valve

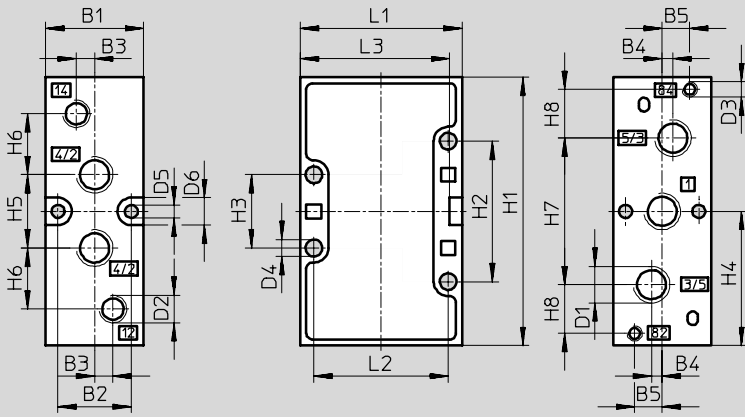

Installation dimensions with F solenoid coil, mechanical or pneumatic reset

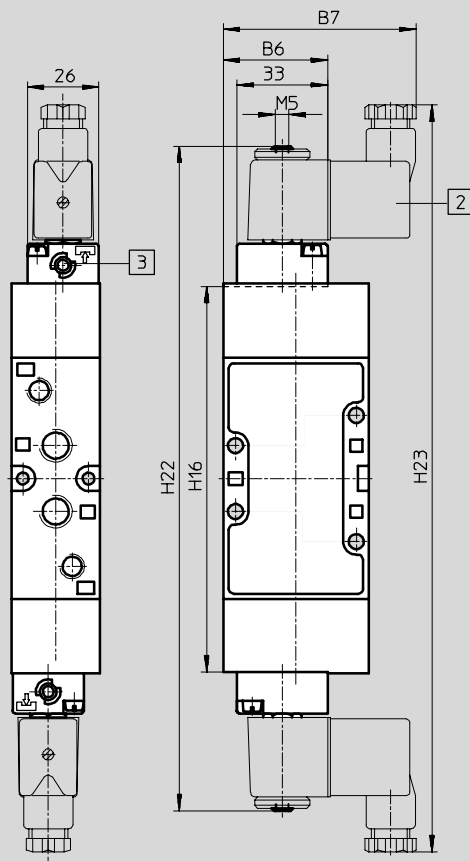

- 2 Solenoid coil is 360° rotatable
- 3 Manual override can be repositioned by 180°

Pneumatic connection	B1	B2	B3	B4	B5	B6	B7	D1	D2	D3	D4	D5	D6	H1
G $\frac{1}{8}$	26	19.5	5	3.5	8	36.8	67	G $\frac{1}{8}$	G $\frac{1}{8}$	M5	4.5	4.3	9	77
G $\frac{1}{4}$	32	24	6	3.5	9	38	70	G $\frac{1}{4}$	G $\frac{1}{8}$	M5	5.5	4.3	9	88

Pneumatic connection	H2	H3	H4	H5	H6	H7	H8	H16	H22	H23	L1	L2	L3
G $\frac{1}{8}$	41	21	38.5	22	19	42	12	129	227	260	47	40	43
G $\frac{1}{4}$	46	24	44	24	20	48	16	141.5	240	273	53	44	79

Solenoid valves MFH-B, Tiger 2000

Technical data – 5/3-way valves



Dimensions – Pneumatic connection G $\frac{3}{8}$

Download CAD data → www.festo.com/en/engineering

Basic valve

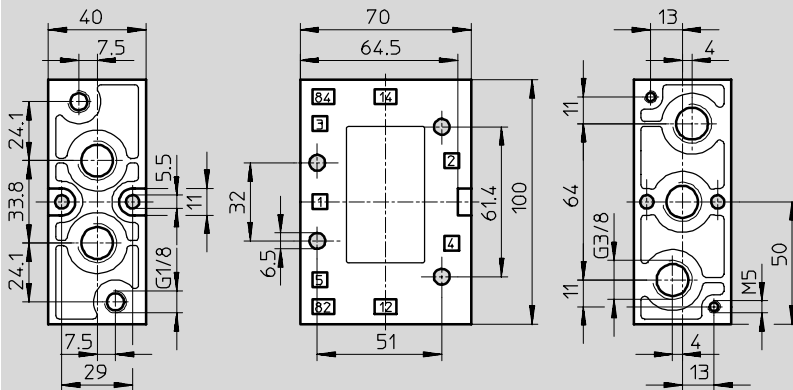

Installation dimensions with F solenoid coil, mechanical or pneumatic reset

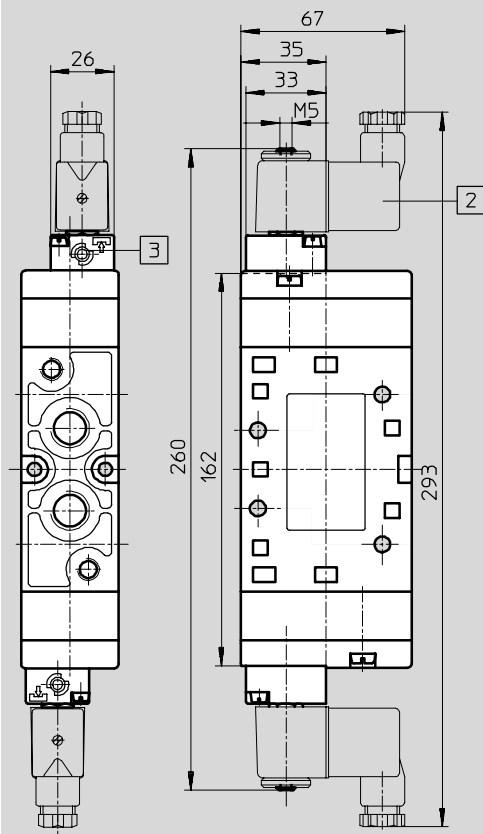

- 2 Solenoid coil is 360° rotatable
- 3 Manual override can be repositioned by 180°

Solenoid valves MFH-B, Tiger 2000

Technical data – 5/3-way valves



Directional control valves for standard applications
Tiger 2000

2.2

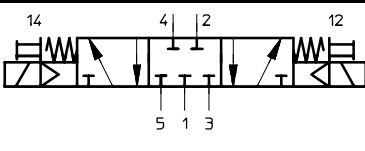
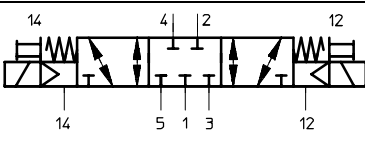
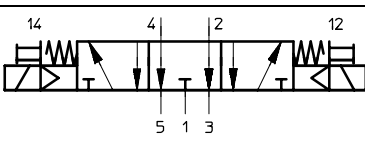
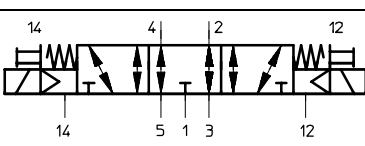
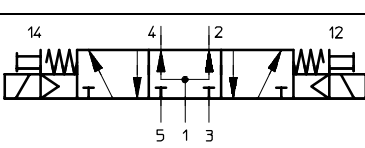
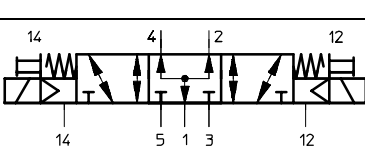
Ordering data				
Circuit symbol	Description	Pneumatic connection	Part No.	Type
	Without F solenoid coil ¹⁾ , normally closed, internal pilot air supply	G $\frac{1}{8}$	30 484	MFH-5/3G-$\frac{1}{8}$-B
		G $\frac{1}{4}$	19 787	MFH-5/3G-$\frac{1}{4}$-B
		G $\frac{3}{8}$	19 707	MFH-5/3G-$\frac{3}{8}$-B
	Without F solenoid coil ¹⁾ , normally closed, external pilot air supply	G $\frac{1}{8}$	30 993	MFH-5/3G-$\frac{1}{8}$-S-B
		G $\frac{1}{4}$	31 001	MFH-5/3G-$\frac{1}{4}$-S-B
		G $\frac{3}{8}$	31 317	MFH-5/3G-$\frac{3}{8}$-S-B
	Without F solenoid coil ¹⁾ , normally exhausted, internal pilot air supply	G $\frac{1}{8}$	30 483	MFH-5/3E-$\frac{1}{8}$-B
		G $\frac{1}{4}$	19 786	MFH-5/3E-$\frac{1}{4}$-B
		G $\frac{3}{8}$	19 708	MFH-5/3E-$\frac{3}{8}$-B
	Without F solenoid coil ¹⁾ , normally exhausted, external pilot air supply	G $\frac{1}{8}$	30 994	MFH-5/3E-$\frac{1}{8}$-S-B
		G $\frac{1}{4}$	31 002	MFH-5/3E-$\frac{1}{4}$-S-B
		G $\frac{3}{8}$	31 318	MFH-5/3E-$\frac{3}{8}$-S-B
	Without F solenoid coil ¹⁾ , normally pressurised, internal pilot air supply	G $\frac{1}{8}$	30 485	MFH-5/3B-$\frac{1}{8}$-B
		G $\frac{1}{4}$	19 788	MFH-5/3B-$\frac{1}{4}$-B
		G $\frac{3}{8}$	19 709	MFH-5/3B-$\frac{3}{8}$-B
	Without F solenoid coil ¹⁾ , normally pressurised, external pilot air supply	G $\frac{1}{8}$	30 995	MFH-5/3B-$\frac{1}{8}$-S-B
		G $\frac{1}{4}$	31 003	MFH-5/3B-$\frac{1}{4}$-S-B
		G $\frac{3}{8}$	31 319	MFH-5/3B-$\frac{3}{8}$-S-B

1) F solenoid coils → 2 / 2.2-66

Solenoid valves MVH-B, Tiger 2000

Technical data – 5/2-way valves



-  - Flow rate
750 ... 2000 l/min

-  - Voltage
24 V DC

Wearing parts kits
→ 2 / 2.2-34

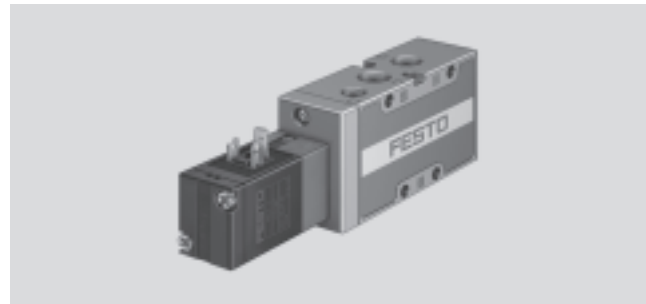

General technical data						
Pneumatic connection	G $\frac{1}{8}$		G $\frac{1}{4}$		G $\frac{3}{8}$	
Type of reset	Mechanical	Pneumatic	Mechanical	Pneumatic	Mechanical	Pneumatic
Valve function	5/2-way, single solenoid					
Constructional design	Poppet	Piston spool	Poppet	Piston spool	Piston spool	
Sealing principle	Soft					
Actuation type	Electrical					
Type of pilot control	Piloted					
Pilot air supply	Internal or external					
Direction of flow	Non-reversible					
Exhaust function	With flow control					
Manual override	Resetting, detenting, covered					
Type of mounting	Via through-holes					
Mounting position	Any					
Nominal size	[mm]	5	8	7	10	12
Standard nominal flow rate	[l/min]	750	1000	1300	1600	2000
Grid dimension	[mm]	27		33		41
Product weight	[g]	230	290	360	495	750

Operating and environmental conditions							
Pneumatic connection	G $\frac{1}{8}$		G $\frac{1}{4}$		G $\frac{3}{8}$		
Type of reset	Pneumatic	Mechanical	Pneumatic	Mechanical	Pneumatic	Mechanical	
Operating medium	Filtered compressed air, lubricated or unlubricated Vacuum						
Operating pressure	Internal pilot air supply	[bar]	3 ... 10	2 ... 10	3 ... 10	2 ... 10	2 ... 10
	External pilot air supply	[bar]	-0.9 ... +10	0 ... 10	-0.9 ... +10	0 ... 10	-0.9 ... +10
Pilot pressure	[bar]	3 ... 10	2 ... 10	3 ... 10	1.5 ... 10	2 ... 10	2 ... 10
Ambient temperature	[°C]	-5 ... +50					
Temperature of medium	[°C]	-5 ... +50					

Solenoid valves MVH-B, Tiger 2000

Technical data – 5/2-way valves



Minimum pilot pressure p_{12}/p_{14} as a function of the operating pressure p_1 (external pilot air supply)

MVH-5-1/8-S-B

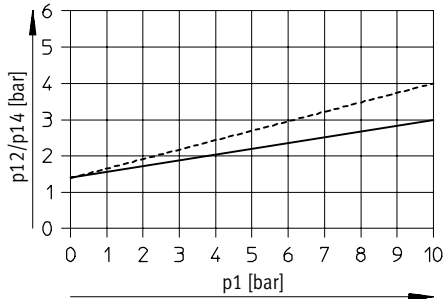

----- Exhaust throttled
 ————— Exhaust unthrottled

MVH-5-1/4-S-B

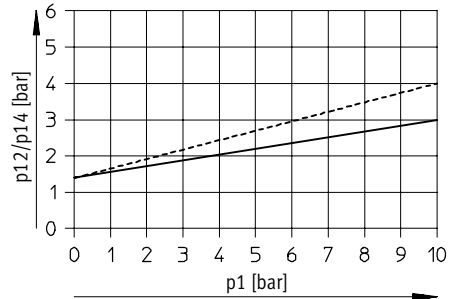

----- Exhaust throttled
 ————— Exhaust unthrottled

MVH-5-3/8-S-B

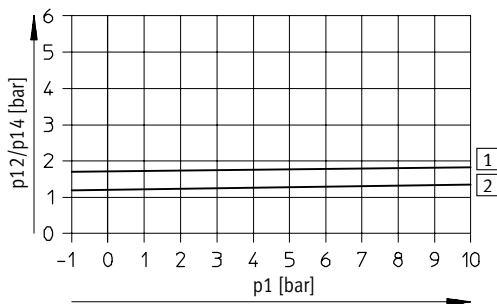

1 On
 2 Off

Valve response times [ms]

Pneumatic connection	G1/8		G1/4		G3/8	
	Pneumatic	Mechanical	Pneumatic	Mechanical	Pneumatic	Mechanical
On	31	20	33	15	22	22
Off	18	36	40	36	60	60

Solenoid valves MVH-B, Tiger 2000

Technical data – 5/2-way valves

Electrical data			
V solenoid			
Electrical connection		To DIN EN 175301-803 type B	
Operating voltage	D.C. voltage	[V DC]	24
Coil characteristics	D.C. voltage	[W]	2.5
Protection class to EN 60 529		IP65 (in combination with plug socket)	

Materials

Sectional view

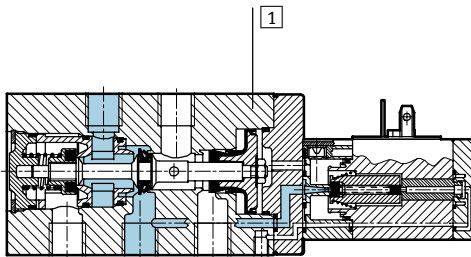

1	Housing	Die-cast aluminium, plastic
-	Seals	Nitrile rubber

Solenoid valves MVH-B, Tiger 2000

Technical data – 5/2-way valves



Dimensions – Pneumatic connection G $\frac{1}{8}$, G $\frac{1}{4}$ Download CAD data → www.festo.com/en/engineering
 Basic valve

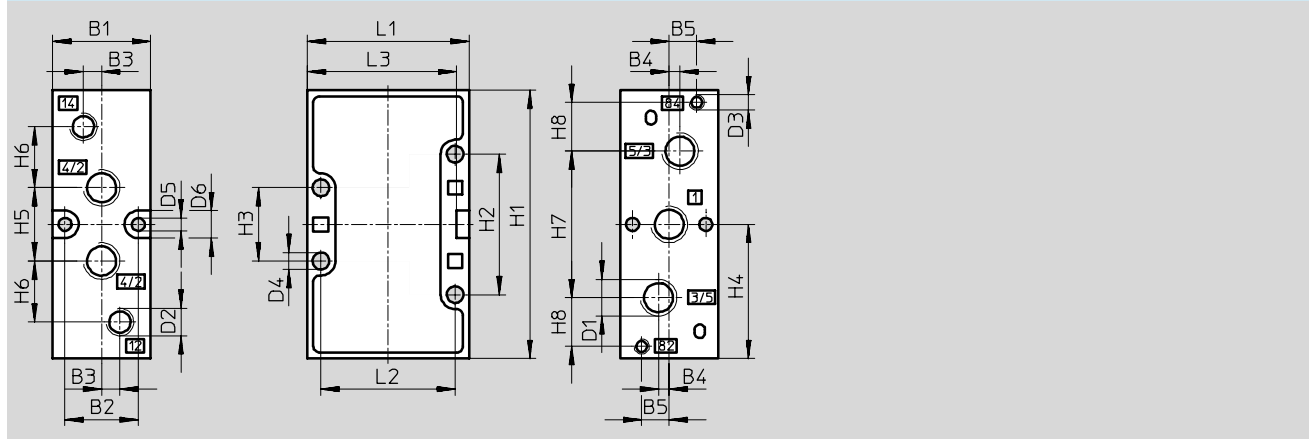

Installation dimensions with V solenoid coil
 Mechanical reset Pneumatic reset

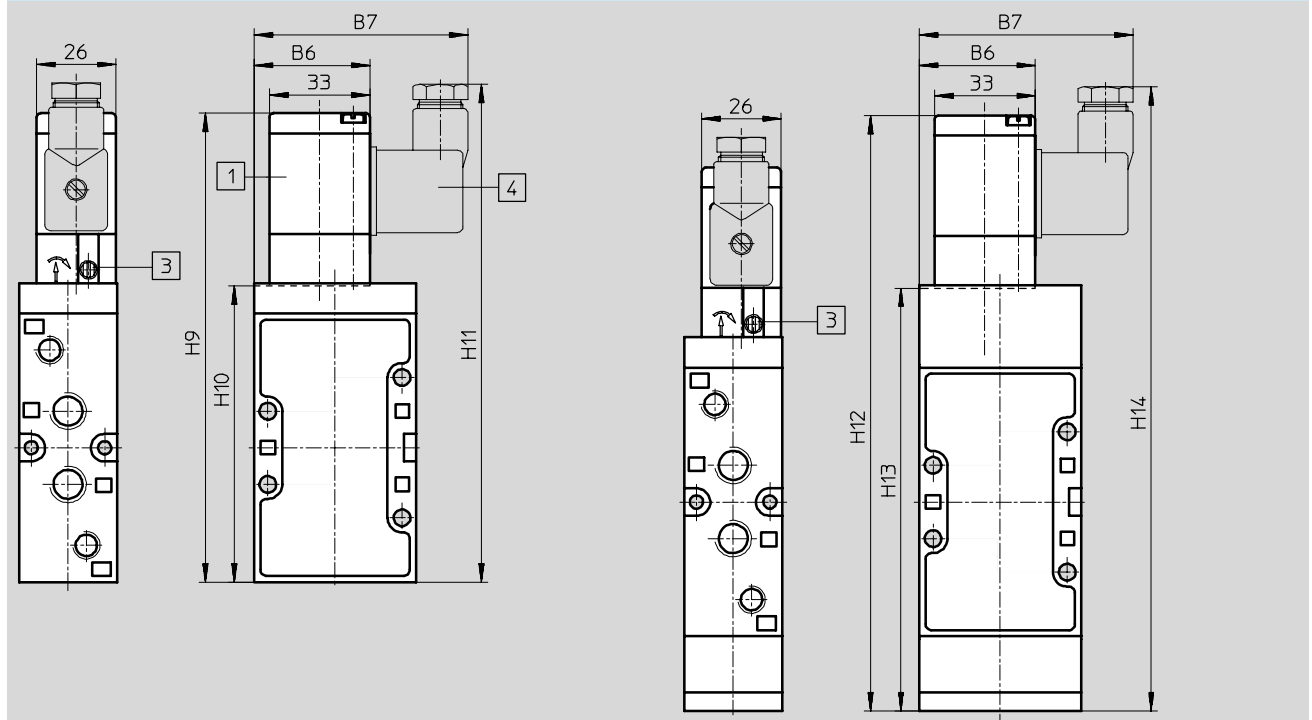

- 1 Solenoid coil can be repositioned by 180°
- 3 Manual override can be repositioned by 180°
- 4 Plug socket connection to EN 175301-803 type B

Pneumatic connection	B1	B2	B3	B4	B5	B6	B7	D1	D2	D3	D4	D5	D6	H1	H2	H3	H4
G $\frac{1}{8}$	26	19.5	5	3.5	8	36.8	67	G $\frac{1}{8}$	G $\frac{1}{8}$	M5	4.5	4.3	9	77	41	21	38.5
G $\frac{1}{4}$	32	24	6	3.5	9	38	70	G $\frac{1}{4}$	G $\frac{1}{8}$	M5	5.5	4.3	9	88	46	24	44

Pneumatic connection	H5	H6	H7	H8	H9	H10	H11	H12	H13	H14	H18	H19	H20	H21	L1	L2	L3
G $\frac{1}{8}$	22	19	42	12	143	86.5	153	183	126.2	193	136	152	175	192	47	40	43
G $\frac{1}{4}$	24	20	48	16	154	97.5	163	196	139	206	147	163	188	205	53	44	79

Directional control valves for standard applications
Tiger 2000

2.2

Solenoid valves MVH-B, Tiger 2000

Technical data – 5/2-way valves



Dimensions – Pneumatic connection G $\frac{3}{8}$

Download CAD data → www.festo.com/en/engineering

Basic valve

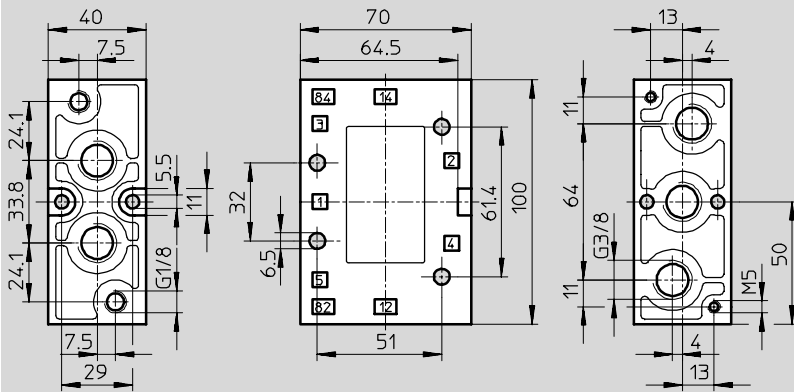

Installation dimensions with V solenoid coil

Mechanical or pneumatic reset

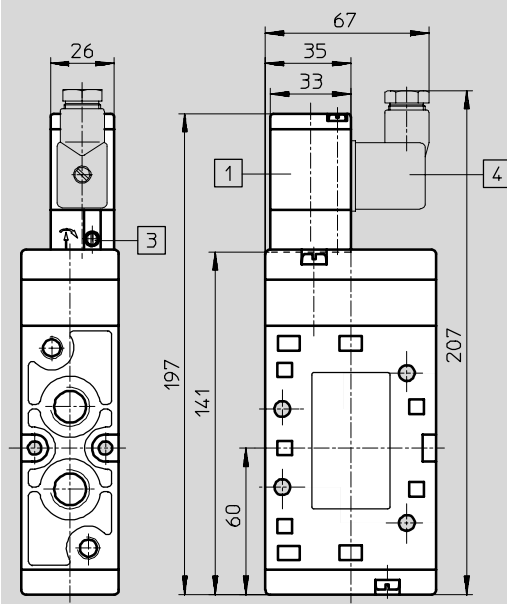

- 1 Solenoid coil is 360° rotatable
- 3 Manual override can be repositioned by 180°
- 4 Plug socket connection to EN 175301-803 type B

Directional control valves for standard applications
Tiger 2000

2.2

Solenoid valves MVH-B, Tiger 2000

Technical data – 5/2-way valves



Directional control valves for standard applications
Tiger 2000

2.2

Ordering data					
Circuit symbol	Description	Voltage	Pneumatic connection	Part No.	Type
	With V solenoid coil, pneumatic reset, internal pilot air supply	24 V DC	G $\frac{1}{8}$	19 749	MVH-5-$\frac{1}{8}$-L-B
			G $\frac{1}{4}$	31 009	MVH-5-$\frac{1}{4}$-L-B
			G $\frac{3}{8}$	14 947	MVH-5-$\frac{3}{8}$-L-B
	With V solenoid coil, pneumatic reset, external pilot air supply	24 V DC	G $\frac{1}{8}$	19 750	MVH-5-$\frac{1}{8}$-L-S-B
			G $\frac{1}{4}$	33 184	MVH-5-$\frac{1}{4}$-L-S-B
			G $\frac{3}{8}$	33 180	MVH-5-$\frac{3}{8}$-L-S-B
	With V solenoid coil, mechanical reset, internal pilot air supply	24 V DC	G $\frac{1}{8}$	19 779	MVH-5-$\frac{1}{8}$-B
			G $\frac{1}{4}$	15 701	MVH-5-$\frac{1}{4}$-B
			G $\frac{3}{8}$	19 945	MVH-5-$\frac{3}{8}$-B
	With V solenoid coil, mechanical reset, external pilot air supply	24 V DC	G $\frac{1}{8}$	30 996	MVH-5-$\frac{1}{8}$-S-B
			G $\frac{1}{4}$	15 903	MVH-5-$\frac{1}{4}$-S-B
			G $\frac{3}{8}$	15 342	MVH-5-$\frac{3}{8}$-S-B

Ordering data – Wearing parts kits		
Pneumatic connection	Part No.	Type
G $\frac{1}{8}$	125 071	MVH-5-$\frac{1}{8}$-B
G $\frac{1}{4}$	115 588	MVH-5-$\frac{1}{4}$-B
G $\frac{3}{8}$	115 074	MVH-5-$\frac{3}{8}$-B

Solenoid valves JMVH-B, Tiger 2000

Technical data – 5/2-way valves, double solenoid



-  - Flow rate
1000 ... 2000 l/min

-  - Voltage
24 V DC

Wearing parts kits
→ 2 / 2.2-40

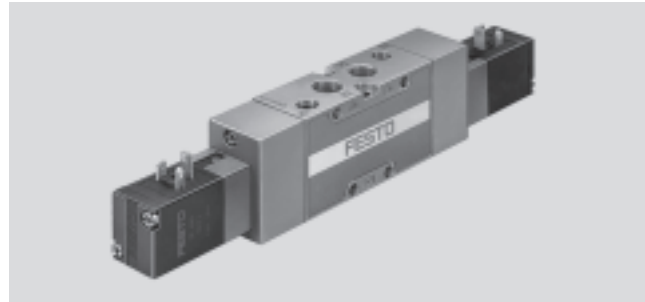

General technical data			
Pneumatic connection	G $\frac{1}{8}$	G $\frac{1}{4}$	G $\frac{3}{8}$
Valve function	5/2-way, double solenoid		
Constructional design	Piston spool		
Sealing principle	Soft		
Actuation type	Electrical		
Type of pilot control	Piloted		
Pilot air supply	Internal or external		
Direction of flow	Non-reversible		
Exhaust function	With flow control		
Manual override	Resetting, detenting, covered		
Type of mounting	Via through-holes		
Mounting position	Any		
Nominal size	[mm] 5	7	12
Standard nominal flow rate	[l/min] 750	1300	2000
Grid dimension	[mm] 27	33	41
Product weight	[g] 560	615	900

Operating and environmental conditions				
Pneumatic connection	G $\frac{1}{8}$	G $\frac{1}{4}$	G $\frac{3}{8}$	
Operating medium	Filtered compressed air, lubricated or unlubricated Vacuum			
Operating pressure	Internal pilot air supply [bar]	2 ... 10	2 ... 10	2 ... 10
	External pilot air supply [bar]	-0.9 ... +10	-0.9 ... +10	-0.9 ... +10
Pilot pressure	[bar]	2 ... 10	2 ... 10	2 ... 10
Ambient temperature	[°C]	-5 ... +50		
Temperature of medium	[°C]	-5 ... +50		

Solenoid valves JMVH-B, Tiger 2000

Technical data – 5/2-way valves, double solenoid



Minimum pilot pressure p_{12}/p_{14} as a function of the operating pressure p_1 (external pilot air supply)

JMVH-5-1/8-S-B

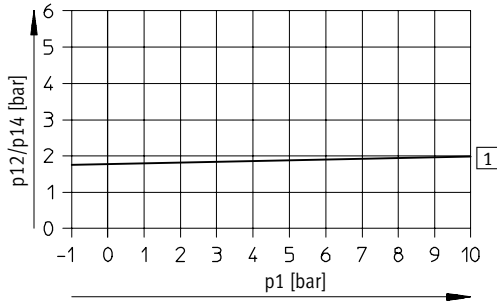

1 On

JMVH-5-1/4-S-B

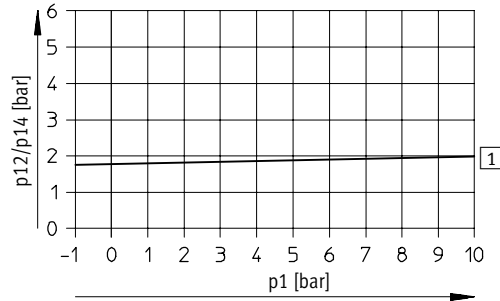

1 On

JMVH-5-3/8-S-B

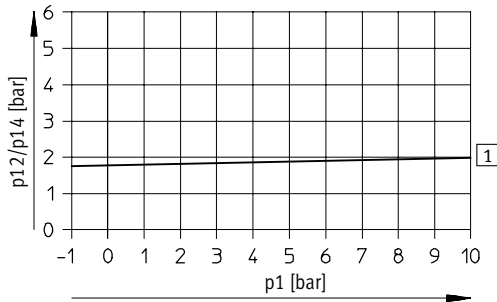

1 On

Valve response times [ms]

Pneumatic connection	G1/8	G1/4	G3/8
Changeover	18	16	17

Solenoid valves JMVH-B, Tiger 2000

Technical data – 5/2-way valves, double solenoid



Electrical data			
V solenoid			
Electrical connection		To DIN EN 175301-803 type B	
Operating voltage	D.C. voltage	[V DC]	24
Coil characteristics	D.C. voltage	[W]	2.5
Protection class to EN 60 529		IP65 (in combination with plug socket)	

Materials

Sectional view

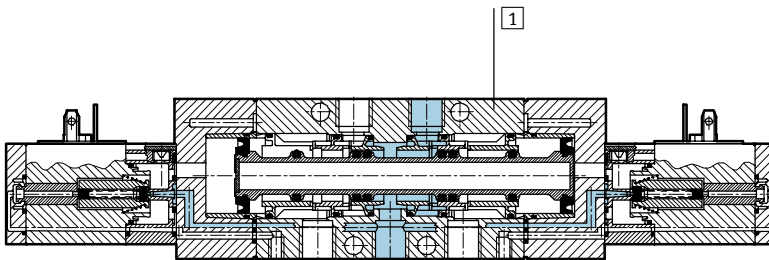

1	Housing	Die-cast aluminium, plastic
-	Seals	Nitrile rubber

Solenoid valves JMVH-B, Tiger 2000

Technical data – 5/2-way valves, double solenoid



Directional control valves for standard applications
Tiger 2000

2.2

Dimensions – Pneumatic connection G¹/₈, G¹/₄

Download CAD data → www.festo.com/en/engineering

Basic valve

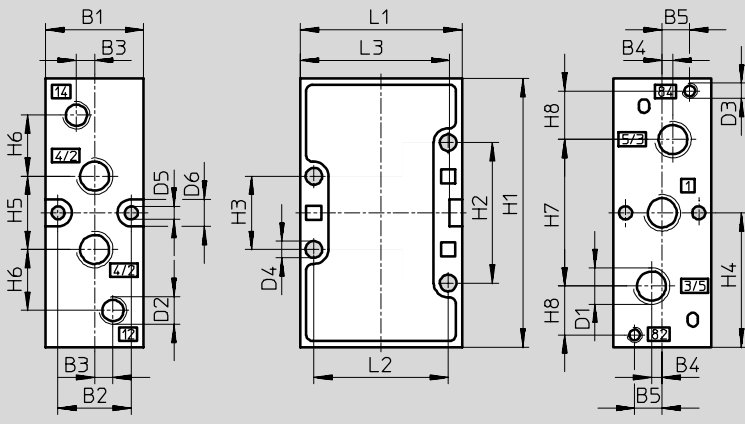

Installation dimensions with V solenoid coil, mechanical or pneumatic reset

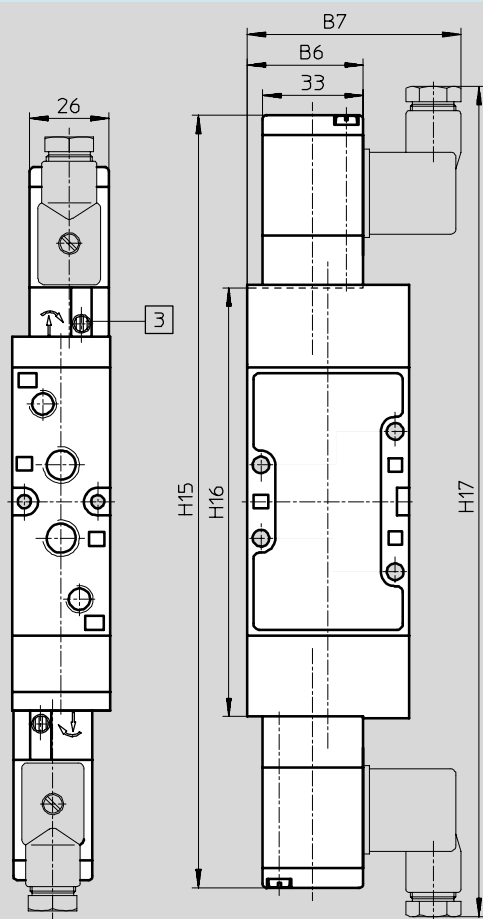

3 Manual override can be repositioned by 180°

Pneumatic connection	B1	B2	B3	B4	B5	B6	B7	D1	D2	D3	D4	D5	D6	H1
G ¹ / ₈	26	19.5	5	3.5	8	36.8	67	G ¹ / ₈	G ¹ / ₈	M5	4.5	4.3	9	77
G ¹ / ₄	32	24	6	3.5	9	38	70	G ¹ / ₄	G ¹ / ₈	M5	5.5	4.3	9	88

Pneumatic connection	H2	H3	H4	H5	H6	H7	H8	H15	H16	H17	L1	L2	L3
G ¹ / ₈	41	21	38.5	22	19	42	12	242	129	262	47	40	43
G ¹ / ₄	46	24	44	24	20	48	16	255	141.5	275	53	44	79

Solenoid valves JMVH-B, Tiger 2000

Technical data – 5/2-way valves, double solenoid



Dimensions – Pneumatic connection G $\frac{3}{8}$

Download CAD data → www.festo.com/en/engineering

Basic valve

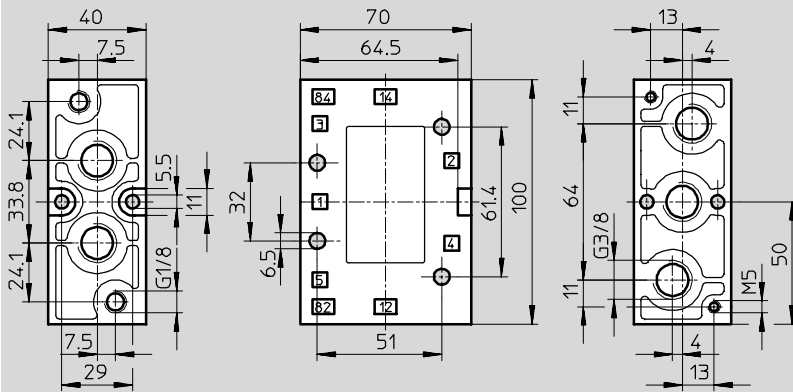

Installation dimensions with V solenoid coil, mechanical or pneumatic reset

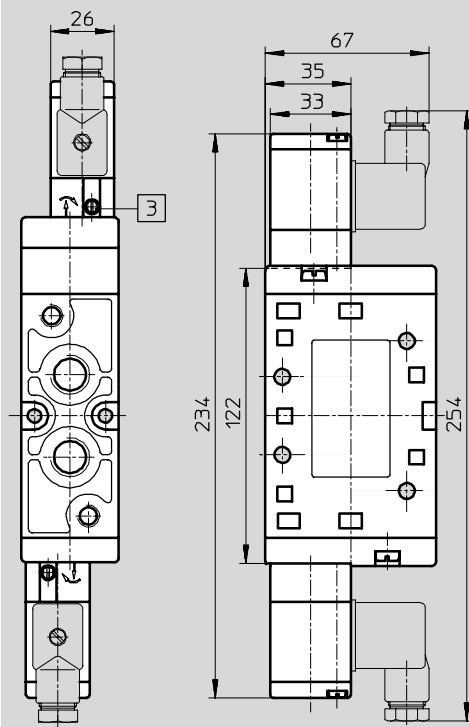

3 Manual override can be repositioned by 180°

Directional control valves for standard applications
Tiger 2000

2.2

Solenoid valves JMVH-B, Tiger 2000

Technical data – 5/2-way valves, double solenoid



Ordering data					
Circuit symbol	Solenoid coil	Voltage	Pneumatic connection	Part No.	Type
	With V solenoid coil, internal pilot air supply	24 V DC	G $\frac{1}{8}$	30 475	JMVH-5-$\frac{1}{8}$-B
			G $\frac{1}{4}$	19 136	JMVH-5-$\frac{1}{4}$-B
			G $\frac{3}{8}$	14 948	JMVH-5-$\frac{3}{8}$-B
	With V solenoid coil, external pilot air supply	24 V DC	G $\frac{1}{8}$	30 476	JMVH-5-$\frac{1}{8}$-S-B
			G $\frac{1}{4}$	19 137	JMVH-5-$\frac{1}{4}$-S-B
			G $\frac{3}{8}$	15 343	JMVH-5-$\frac{3}{8}$-S-B

Ordering data – Wearing parts kits		
Pneumatic connection	Part No.	Type
G $\frac{1}{8}$	115 590	JMVH-5-$\frac{1}{8}$-B-(SB)
G $\frac{1}{4}$	115 589	JMVH-5-$\frac{1}{4}$-B-(SB)

Solenoid valves MVH-B, Tiger 2000

Technical data – 5/3-way valves

FESTO

-  - Flow rate
1000 ... 2600 l/min

-  - Voltage
24 V DC



General technical data				
Pneumatic connection		G $\frac{1}{8}$	G $\frac{1}{4}$	G $\frac{3}{8}$
Valve function		5/3-way, single solenoid		
Constructional design		Piston spool		
Sealing principle		Soft		
Actuation type		Electrical		
Type of reset		Mechanical spring		
Type of pilot control		Piloted		
Pilot air supply		Internal or external		
Direction of flow		Non-reversible		
Exhaust function		With flow control		
Manual override		Resetting, detenting, covered		
Type of mounting		Via through-holes		
Mounting position		Any		
Nominal size		[mm] 5	7	12
Standard nominal flow rate	Closed	[l/min] 1000	1600	2000
	Exhausted	[l/min]		2200
	Pressurised	[l/min]		2600
Grid dimension		[mm] 27	33	41
Product weight		[g] 575	660	1000

Operating and environmental conditions				
Pneumatic connection		G $\frac{1}{8}$	G $\frac{1}{4}$	G $\frac{3}{8}$
Operating medium		Filtered compressed air, lubricated or unlubricated Vacuum		
Operating pressure	Internal pilot air supply	[bar] 3 ... 10	3 ... 10	3 ... 10
	External pilot air supply	[bar] -0.9 ... +10	-0.9 ... +10	-0.9 ... +10
Pilot pressure		[bar] 3 ... 10	3 ... 10	3 ... 10
Ambient temperature		[°C] -5 ... +50		
Temperature of medium		[°C] -5 ... +50		

Directional control valves for standard applications
Tiger 2000

2.2

Solenoid valves MVH-B, Tiger 2000

Technical data – 5/3-way valves



Minimum pilot pressure p_{12}/p_{14} as a function of the operating pressure p_1 (external pilot air supply)

MVH-5/3...-1/8-S-B

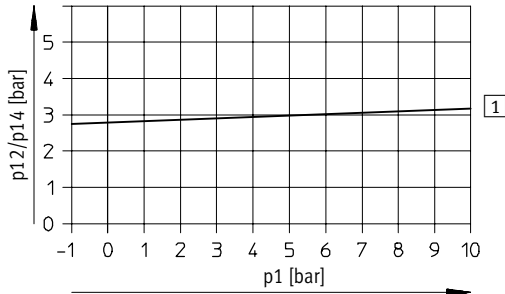

1 On

MVH-5/3...-1/4-S-B

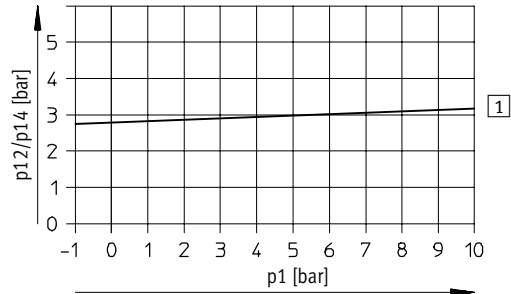

1 On

MVH-5/3...-3/8-S-B

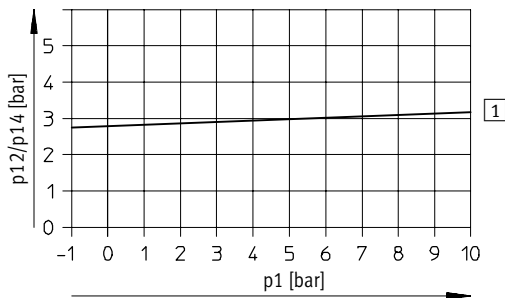

1 On

Valve response times [ms]

Pneumatic connection	G1/8		G1/4		G3/8	
	On	Off	On	Off	On	Off
Closed	18	20	20	22	24	80
Exhausted	20	20	24	36	36	85
Pressurised	24	24	34	30	30	82

Solenoid valves MVH-B, Tiger 2000

Technical data – 5/3-way valves



Electrical data			
V solenoid			
Electrical connection		To DIN EN 175301-803 type B	
Operating voltage	D.C. voltage	[V DC]	24
Coil characteristics	D.C. voltage	[W]	2.5
Protection class to EN 60 529		IP65 (in combination with plug socket)	

Materials

Sectional view

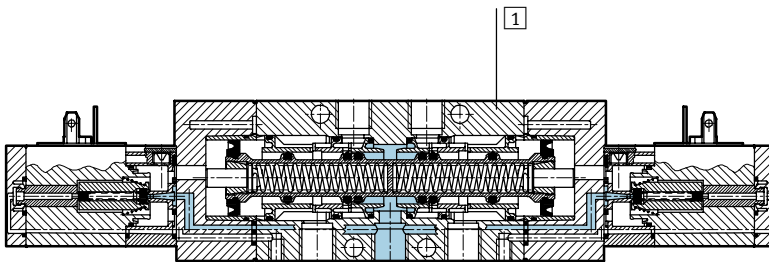

1	Housing	Die-cast aluminium, plastic
-	Seals	Nitrile rubber

Solenoid valves MVH-B, Tiger 2000

Technical data – 5/3-way valves



Directional control valves for standard applications
Tiger 2000

2.2

Dimensions – Pneumatic connection G $\frac{1}{8}$, G $\frac{1}{4}$

Download CAD data → www.festo.com/en/engineering

Basic valve

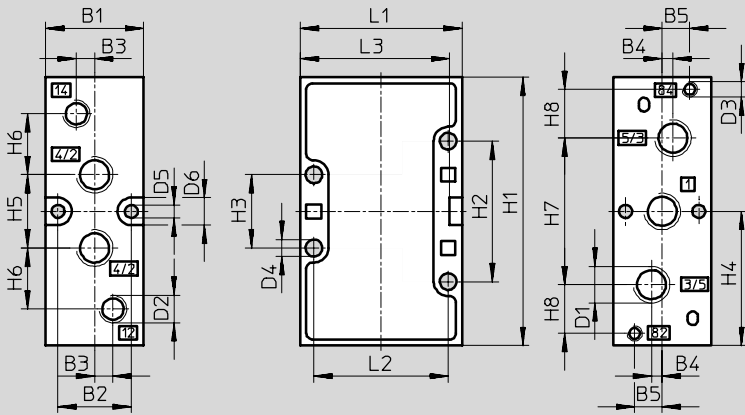

Installation dimensions with V solenoid coil, mechanical or pneumatic reset

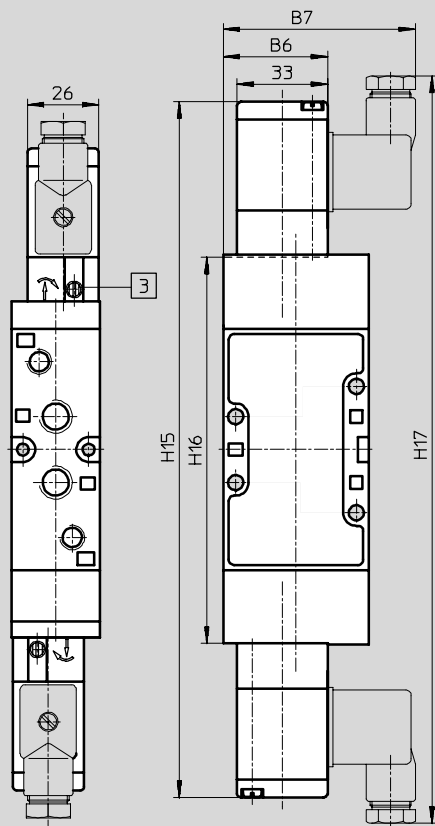

3 Manual override can be repositioned by 180°

Pneumatic connection	B1	B2	B3	B4	B5	B6	B7	D1	D2	D3	D4 Ø	D5 Ø	D6	H1
G $\frac{1}{8}$	26	19.5	5	3.5	8	36.8	67	G $\frac{1}{8}$	G $\frac{1}{8}$	M5	4.5	4.3	9	77
G $\frac{1}{4}$	32	24	6	3.5	9	38	70	G $\frac{1}{4}$	G $\frac{1}{8}$	M5	5.5	4.3	9	88

Pneumatic connection	H2	H3	H4	H5	H6	H7	H8	H15	H16	H17	L1	L2	L3
G $\frac{1}{8}$	41	21	38.5	22	19	42	12	242	129	262	47	40	43
G $\frac{1}{4}$	46	24	44	24	20	48	16	255	141.5	275	53	44	79

Solenoid valves MVH-B, Tiger 2000

Technical data – 5/3-way valves



Dimensions – Pneumatic connection G $\frac{3}{8}$

Download CAD data → www.festo.com/en/engineering

Basic valve

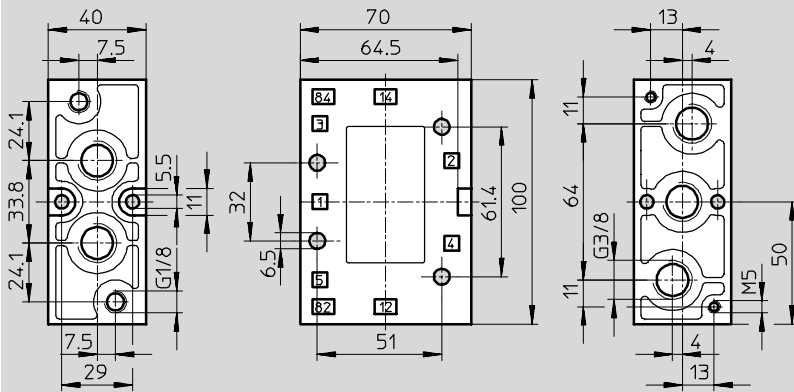

Installation dimensions with V solenoid coil, mechanical or pneumatic reset

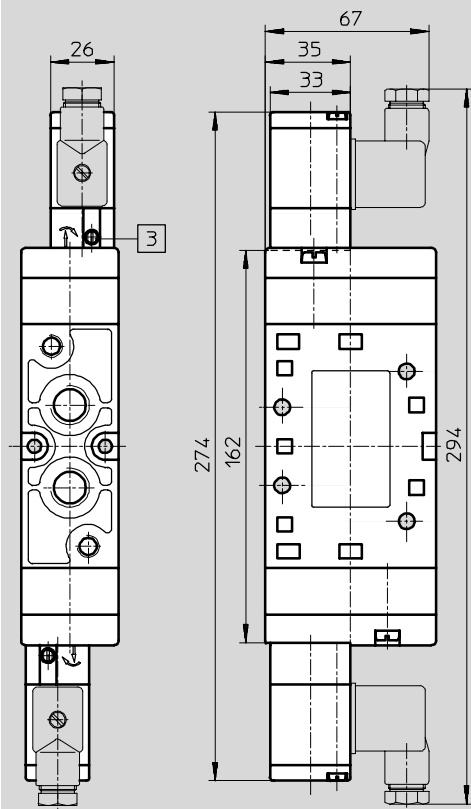

3 Manual override can be repositioned by 180°

Directional control valves for standard applications
Tiger 2000

2.2

Solenoid valves MVH-B, Tiger 2000

Technical data – 5/3-way valves



Directional control valves for standard applications
Tiger 2000

2.2

Ordering data					
Circuit symbol	Description	Voltage	Pneumatic connection	Part No.	Type
	With V solenoid coil, normally closed, internal pilot air supply	24 V DC	G $\frac{1}{8}$	30 477	MVH-5/3G-$\frac{1}{8}$-B
			G $\frac{1}{4}$	19 138	MVH-5/3G-$\frac{1}{4}$-B
			G $\frac{3}{8}$	14 944	MVH-5/3G-$\frac{3}{8}$-B
	With V solenoid coil, normally closed, external pilot air supply	24 V DC	G $\frac{1}{8}$	30 997	MVH-5/3G-$\frac{1}{8}$-S-B
			G $\frac{1}{4}$	31 004	MVH-5/3G-$\frac{1}{4}$-S-B
			G $\frac{3}{8}$	15 346	MVH-5/3G-$\frac{3}{8}$-S-B
	With V solenoid coil, normally exhausted, internal pilot air supply	24 V DC	G $\frac{1}{8}$	30 478	MVH-5/3E-$\frac{1}{8}$-B
			G $\frac{1}{4}$	19 139	MVH-5/3E-$\frac{1}{4}$-B
			G $\frac{3}{8}$	14 943	MVH-5/3E-$\frac{3}{8}$-B
	With V solenoid coil, normally exhausted, external pilot air supply	24 V DC	G $\frac{1}{8}$	30 998	MVH-5/3E-$\frac{1}{8}$-S-B
			G $\frac{1}{4}$	31 005	MVH-5/3E-$\frac{1}{4}$-S-B
			G $\frac{3}{8}$	15 344	MVH-5/3E-$\frac{3}{8}$-S-B
	With V solenoid coil, normally pressurised, internal pilot air supply	24 V DC	G $\frac{1}{8}$	30 480	MVH-5/3B-$\frac{1}{8}$-B
			G $\frac{1}{4}$	19 140	MVH-5/3B-$\frac{1}{4}$-B
			G $\frac{3}{8}$	19 699	MVH-5/3B-$\frac{3}{8}$-B
	With V solenoid coil, normally pressurised, external pilot air supply	24 V DC	G $\frac{1}{8}$	30 999	MVH-5/3B-$\frac{1}{8}$-S-B
			G $\frac{1}{4}$	31 006	MVH-5/3B-$\frac{1}{4}$-S-B
			G $\frac{3}{8}$	15 348	MVH-5/3B-$\frac{3}{8}$-S-B

Pneumatic valves, Tiger 2000

Peripherals overview

FESTO

Mounting on manifold

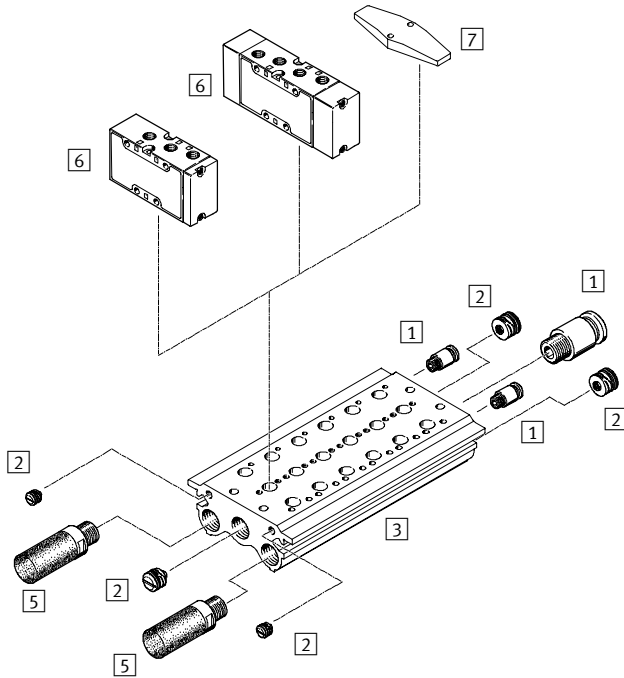

Mounting on manifold strip

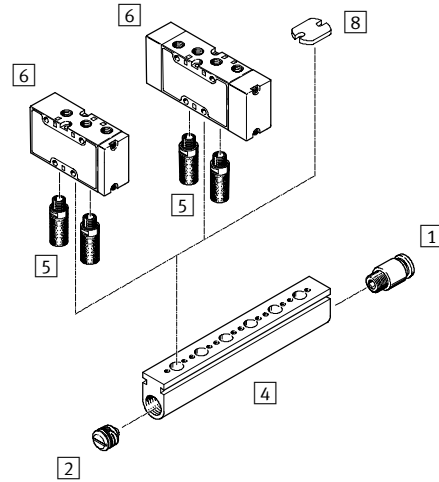

Accessories

	Brief description	→ Page
1	Push-in fitting QS	Volume 3
2	Sealing plug PRSV	2 / 2.2-64
3	Manifold PRS	2 / 2.2-62
4	Manifold strip PAL	2 / 2.2-60
5	Silencer	For fitting in exhaust ports Volume 3
6	Pneumatic valve VL, J	2 / 2.2-5
7	Blanking plate PRSB	For covering vacant positions 2 / 2.2-64
8	Blanking plate PALB	For covering vacant positions 2 / 2.2-64

Pneumatic valves, Tiger 2000

Type code



		VL	-	5/3	G	-	1/8	-	B
Type									
VL	Single pilot								
J	Double pilot								
Valve function									
5	5/2-way valve								
5/3	5/3-way valve								
Normal position									
G	Closed								
E	Exhausted								
B	Pressurised								
Pneumatic connection									
1/8	G1/8								
1/4	G1/4								
3/8	G3/8								
Generation									
B	Series B								

Pneumatic valves VL, Tiger 2000

Technical data – 5/2-way valves



-  - Flow rate
750 ... 2000 l/min

Wearing parts kits
→ 2 / 2.2-52



General technical data			
Pneumatic connection	G $\frac{1}{8}$	G $\frac{1}{4}$	G $\frac{3}{8}$
Valve function	5/2-way, single pilot		
Constructional design	Poppet		Piston spool
Sealing principle	Soft		
Actuation type	Pneumatic		
Type of reset	Mechanical spring		
Type of pilot control	Direct		
Direction of flow	Non-reversible		Reversible
Exhaust function	With flow control		
Manual override	None		
Type of mounting	Via through-holes		
Mounting position	Any		
Nominal size	[mm] 5	7	12
Standard nominal flow rate	[l/min] 750	1300	2000
Grid dimension	[mm] 27	33	41
Product weight	[g] 170	240	570

Operating and environmental conditions			
Pneumatic connection	G $\frac{1}{8}$	G $\frac{1}{4}$	G $\frac{1}{4}$
Operating medium	Filtered compressed air, lubricated or unlubricated Vacuum		
Operating pressure	[bar] 0 ... 10	0 ... 10	-0.9 ... +10
Pilot pressure	[bar] 1.5 ... 10	1.5 ... 10	2 ... 10
Ambient temperature	[°C] -10 ... +60		
Temperature of medium	[°C] -10 ... +60		

Directional control valves for standard applications
Tiger 2000

2.2

Pneumatic valves VL, Tiger 2000

Technical data – 5/2-way valves



Minimum pilot pressure p_{12} , p_{14} as a function of the operating pressure p_1

VL-5-1/8-B

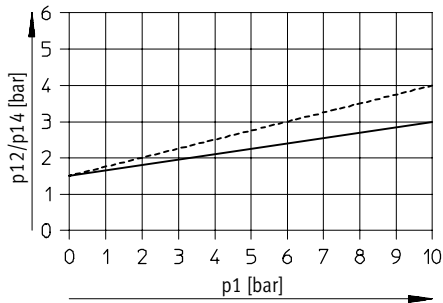

----- Exhaust throttled
 ———— Exhaust unthrottled

VL-5-1/4-B

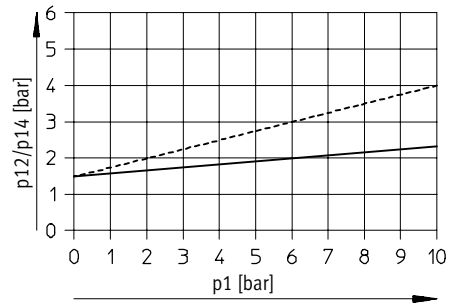

----- Exhaust throttled
 ———— Exhaust unthrottled

VL-5-3/8-B

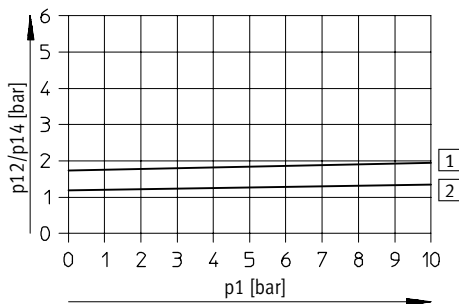

1 On
 2 Off

Valve response times [ms]

Pneumatic connection	G1/8	G1/4	G3/8
On	2	2	4
Off	10	12	16

Materials

Sectional view

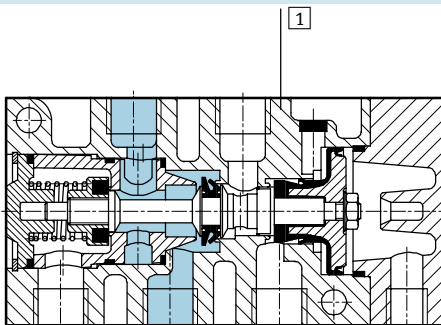

1	Housing	Die-cast aluminium
-	Seals	Nitrile rubber

Pneumatic valves VL, Tiger 2000

Technical data – 5/2-way valves



Dimensions – Pneumatic connection G $\frac{1}{8}$, G $\frac{1}{4}$ Download CAD data → www.festo.com/en/engineering
 Basic valve VL-5-...-B

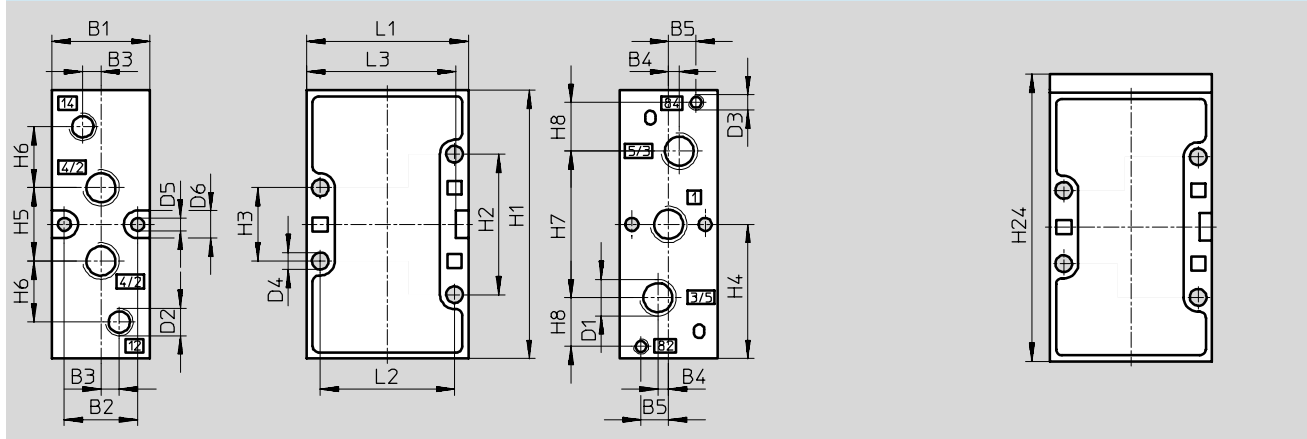

Pneumatic connection	B1	B2	B3	B4	B5	D1	D2	D3	D4	D5	D6	H1
G $\frac{1}{8}$	26	19.5	5	3.5	8	G $\frac{1}{8}$	G $\frac{1}{8}$	M5	4.5	4.3	9	77
G $\frac{1}{4}$	32	24	6	3.5	9	G $\frac{1}{4}$	G $\frac{1}{8}$	M5	5.5	4.3	9	88

Pneumatic connection	H2	H3	H4	H5	H6	H7	H8	H24	L1	L2	L3
G $\frac{1}{8}$	41	21	38.5	22	19	42	12	83	47	40	43
G $\frac{1}{4}$	46	24	44	24	20	48	16	94	53	44	79

Dimensions – Pneumatic connection G $\frac{3}{8}$ Download CAD data → www.festo.com/en/engineering
 Basic valve VL-5- $\frac{3}{8}$ -B

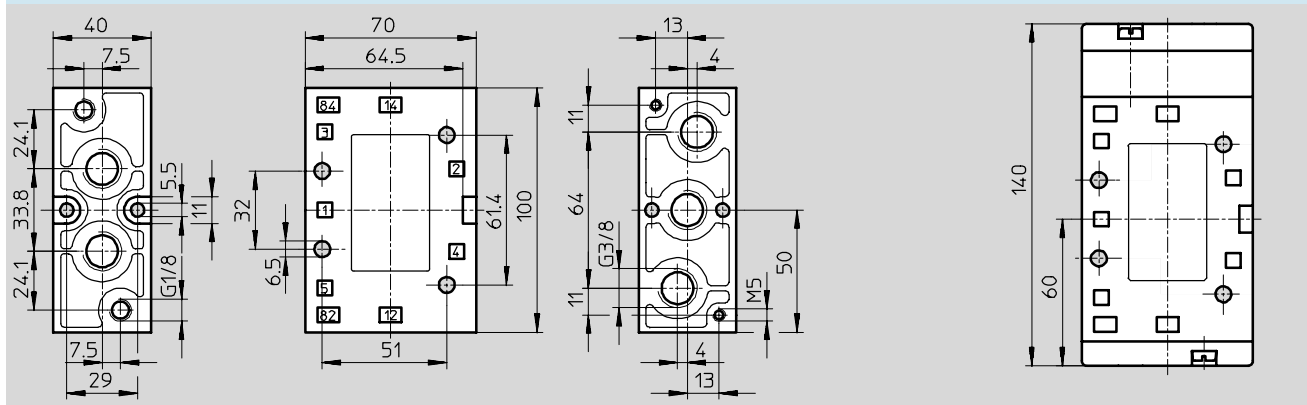

Directional control valves for standard applications
 Tiger 2000
2.2

Pneumatic valves VL, Tiger 2000

Technical data – 5/2-way valves



Directional control valves for standard applications
Tiger 2000

Ordering data				
Circuit symbol	Description	Pneumatic connection	Part No.	Type
	Mechanical reset	G $\frac{1}{8}$	31 000	VL-5- $\frac{1}{8}$ -B
		G $\frac{1}{4}$	14 294	VL-5- $\frac{1}{4}$ -B
		G $\frac{3}{8}$	14 952	VL-5- $\frac{3}{8}$ -B

Ordering data – Wearing parts kits		
Pneumatic connection	Part No.	Type
G $\frac{1}{8}$	125 710	VL-5- $\frac{1}{8}$ -B
G $\frac{1}{4}$	115 580	VL-5- $\frac{1}{4}$ -B

Pneumatic valves J, Tiger 2000

Technical data – 5/2-way valves, double pilot



-  - Flow rate
800 ... 2000 l/min



General technical data				
Pneumatic connection	G1/8	G1/4	G3/8	
Valve function	5/2-way, double pilot			
Constructional design	Piston spool			
Sealing principle	Soft			
Actuation type	Pneumatic			
Type of pilot control	Direct			
Direction of flow	Reversible			
Exhaust function	With flow control			
Manual override	None			
Type of mounting	Via through-holes			
Mounting position	Any			
Nominal size	[mm]	8	10	12
Standard nominal flow rate	[l/min]	800	1600	2000
Grid dimension	[mm]	27	33	41
Product weight	[g]	320	375	550

Operating and environmental conditions				
Pneumatic connection	G1/8	G1/4	G1/4	
Operating medium	Filtered compressed air, lubricated or unlubricated Vacuum			
Operating pressure	[bar]	-0.9 ... +10	-0.9 ... +10	-0.9 ... +10
Pilot pressure	[bar]	3 ... 10	3 ... 10	3 ... 10
Ambient temperature	[°C]	-10 ... +60		
Temperature of medium	[°C]	-10 ... +60		

Directional control valves for standard applications
Tiger 2000

2.2

Pneumatic valves J, Tiger 2000

Technical data – 5/2-way valves, double pilot



Minimum pilot pressure p_{12}/p_{14} as a function of the operating pressure p_1

J-5-1/8-B

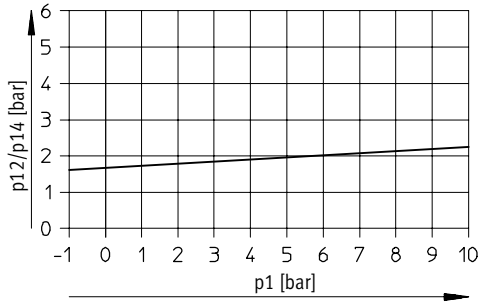

J-5--1/4-B

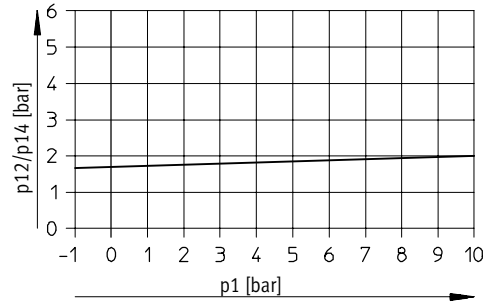

J-5-3/8-B

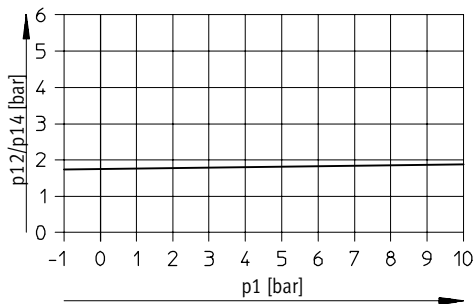

Valve response times [ms]

Pneumatic connection	G1/8	G1/4	G3/8
Changeover	3	3	3

Materials

Sectional view

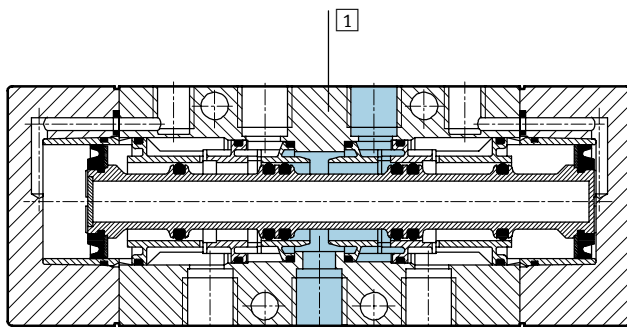

1	Housing	Die-cast aluminium
-	Seals	Nitrile rubber

Pneumatic valves J, Tiger 2000

Technical data – 5/2-way valves, double pilot



Dimensions – Pneumatic connection G $\frac{1}{8}$, G $\frac{1}{4}$ Download CAD data → www.festo.com/en/engineering
 Basic valve J-5-...-B

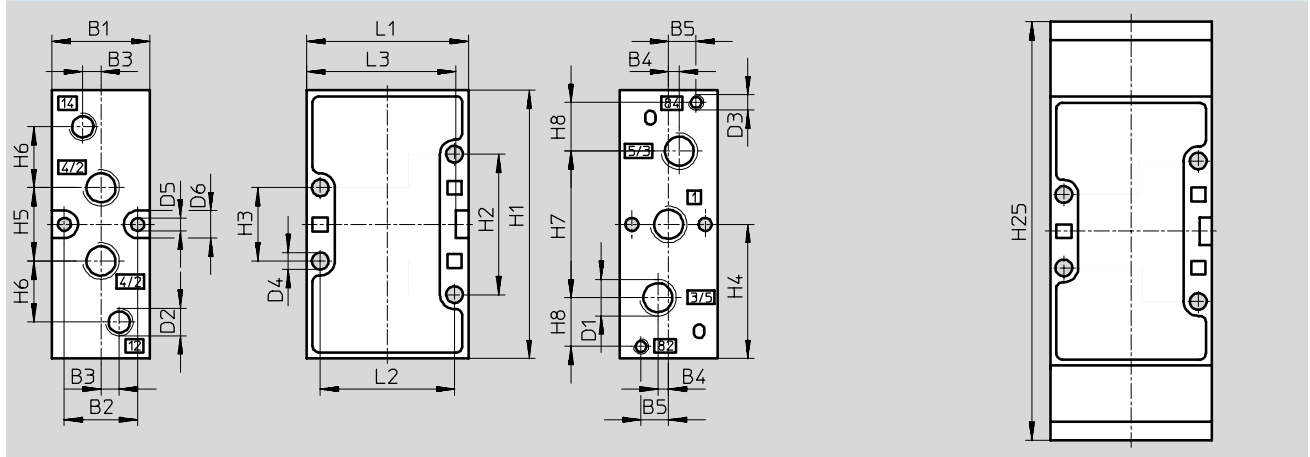

Pneumatic connection	B1	B2	B3	B4	B5	D1	D2	D3	D4	D5	D6	H1
G $\frac{1}{8}$	26	19.5	5	3.5	8	G $\frac{1}{8}$	G $\frac{1}{8}$	M5	4.5	4.3	9	77
G $\frac{1}{4}$	32	24	6	3.5	9	G $\frac{1}{4}$	G $\frac{1}{8}$	M5	5.5	4.3	9	88

Pneumatic connection	H2	H3	H4	H5	H6	H7	H8	H25	L1	L2	L3
G $\frac{1}{8}$	41	21	38.5	22	19	42	12	124	47	40	43
G $\frac{1}{4}$	46	24	44	24	20	48	16	137	53	44	79

Dimensions – Pneumatic connection G $\frac{3}{8}$ Download CAD data → www.festo.com/en/engineering
 Basic valve J-5- $\frac{3}{8}$ -B

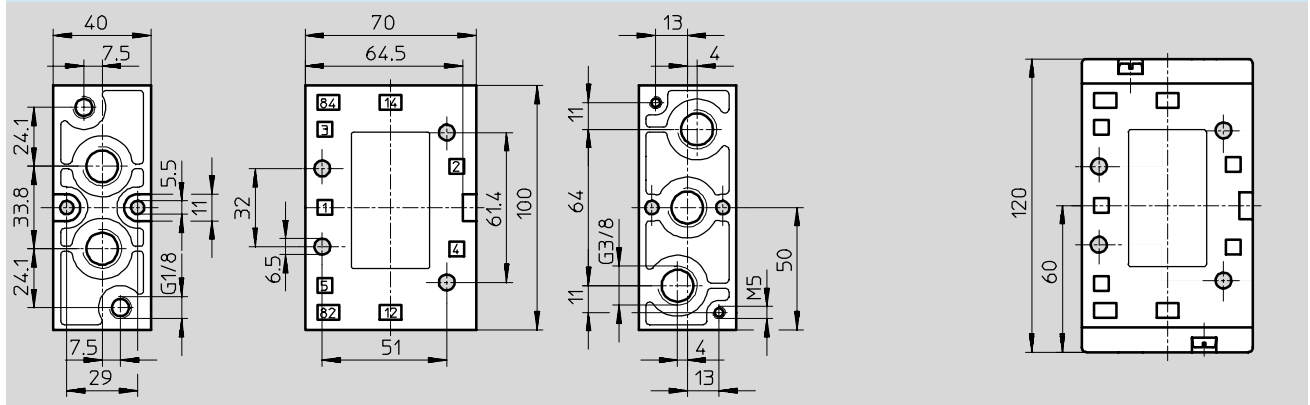

Ordering data		
Circuit symbol	Pneumatic connection	Part No. Type
	G $\frac{1}{8}$	30 988 J-5- $\frac{1}{8}$ -B
	G $\frac{1}{4}$	14 295 J-5- $\frac{1}{4}$ -B
	G $\frac{3}{8}$	14 953 J-5- $\frac{3}{8}$ -B

Directional control valves for standard applications
 Tiger 2000
2.2

Pneumatic valves VL, Tiger 2000

Technical data – 5/3-way valves



-  - Flow rate
800 ... 2000 l/min



Directional control valves for standard applications
Tiger 2000

2.2

General technical data			
Pneumatic connection	G1/8	G1/4	G3/8
Valve function	5/3-way, single pilot		
Constructional design	Piston spool		
Sealing principle	Soft		
Actuation type	Pneumatic		
Type of reset	Mechanical spring		
Type of pilot control	Direct		
Direction of flow	Reversible		
Exhaust function	With flow control		
Manual override	None		
Type of mounting	Via through-holes		
Mounting position	Any		
Nominal size	[mm] 8	10	12
Standard nominal flow rate	[l/min] 800	1600	2000
Grid dimension	[mm] 27	33	41
Product weight	[g] 320	375	680

Operating and environmental conditions			
Pneumatic connection	G1/8	G1/4	G3/8
Operating medium	Filtered compressed air, lubricated or unlubricated Vacuum		
Operating pressure	[bar] -0.9 ... +10	-0.9 ... +10	-0.9 ... +10
Pilot pressure	[bar] 3 ... 10	3 ... 10	3 ... 10
Ambient temperature	[°C] -10 ... +60		
Temperature of medium	[°C] -10 ... +60		

Pneumatic valves VL, Tiger 2000

Technical data – 5/3-way valves



Minimum pilot pressure p_{12}/p_{14} as a function of the operating pressure p_1

VL-5/3...-1/8-B

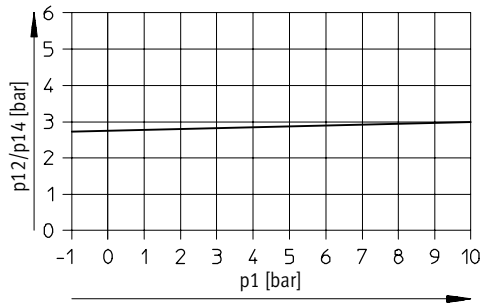

VL-5/3...-1/4-B

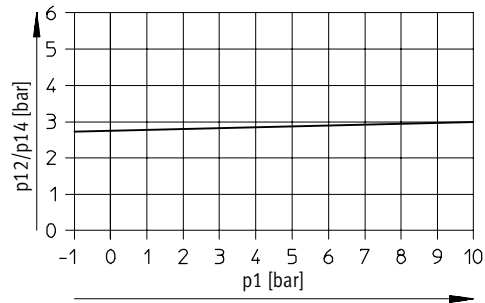

VL-5/3...-3/8-B

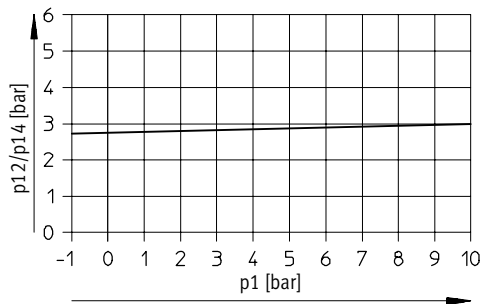

Valve response times [ms]

Pneumatic connection	G1/8	G1/4	G3/8
On	5	6	7
Off	14	26	28

Materials

Sectional view

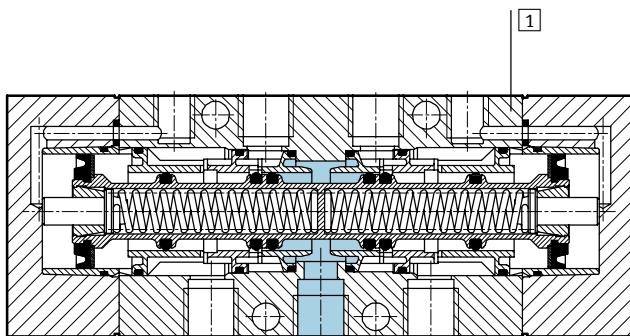

1	Housing	Die-cast aluminium
-	Seals	Nitrile rubber

Pneumatic valves VL, Tiger 2000

Technical data – 5/3-way valves



Dimensions – Pneumatic connection G $\frac{1}{8}$, G $\frac{1}{4}$

Download CAD data → www.festo.com/en/engineering

Basic valve

J-5-...-B

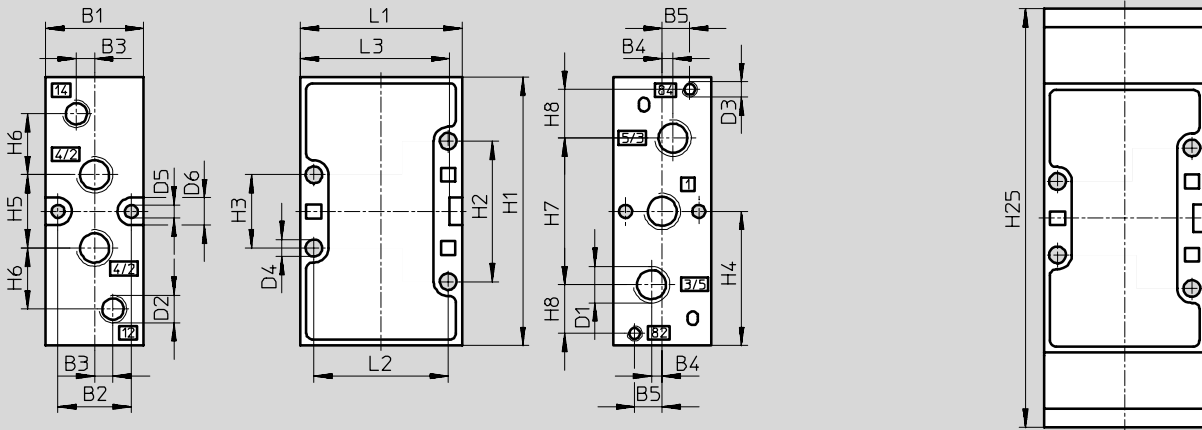

Pneumatic connection	B1	B2	B3	B4	B5	D1	D2	D3	D4	D5	D6	H1
G $\frac{1}{8}$	26	19.5	5	3.5	8	G $\frac{1}{8}$	G $\frac{1}{8}$	M5	4.5	4.3	9	77
G $\frac{1}{4}$	32	24	6	3.5	9	G $\frac{1}{4}$	G $\frac{1}{8}$	M5	5.5	4.3	9	88

Pneumatic connection	H2	H3	H4	H5	H6	H7	H8	H25	L1	L2	L3
G $\frac{1}{8}$	41	21	38.5	22	19	42	12	124	47	40	43
G $\frac{1}{4}$	46	24	44	24	20	48	16	137	53	44	79

Dimensions – Pneumatic connection G $\frac{3}{8}$

Download CAD data → www.festo.com/en/engineering

Basic valve

VL-5/3...- $\frac{3}{8}$ -B

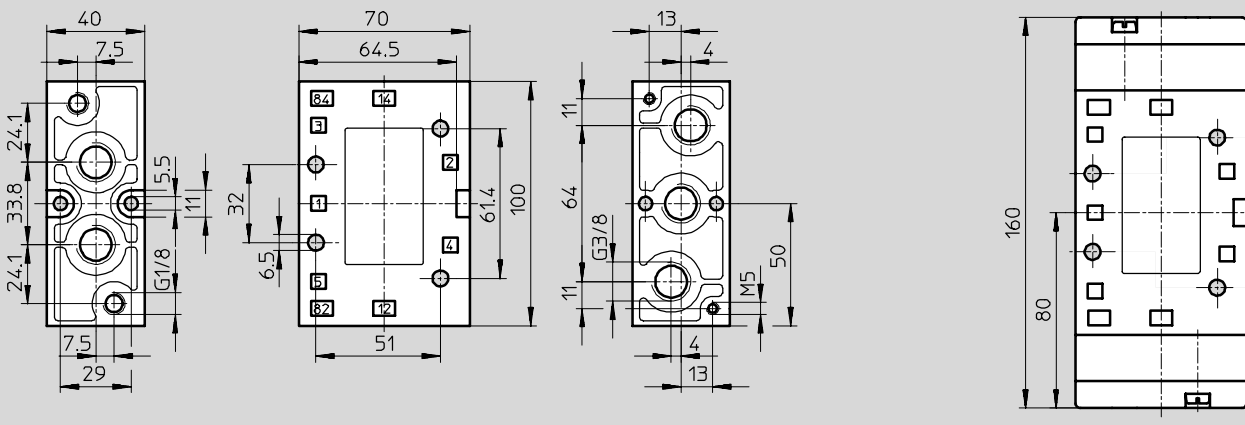

Pneumatic valves VL, Tiger 2000

Technical data – 5/3-way valves



Ordering data			
Circuit symbol	Description	Pneumatic connection	Part No. Type
	Normally closed	G $\frac{1}{8}$	30 990 VL-5/3G- $\frac{1}{8}$ -B
		G $\frac{1}{4}$	14 298 VL-5/3G- $\frac{1}{4}$ -B
		G $\frac{3}{8}$	14 950 VL-5/3G- $\frac{3}{8}$ -B
	Normally exhausted	G $\frac{1}{8}$	31 309 VL-5/3E- $\frac{1}{8}$ -B
		G $\frac{1}{4}$	14 297 VL-5/3E- $\frac{1}{4}$ -B
		G $\frac{3}{8}$	14 949 VL-5/3E- $\frac{3}{8}$ -B
	Normally pressurised	G $\frac{1}{8}$	31 310 VL-5/3B- $\frac{1}{8}$ -B
		G $\frac{1}{4}$	14 298 VL-5/3B- $\frac{1}{4}$ -B
		G $\frac{3}{8}$	14 951 VL-5/3B- $\frac{3}{8}$ -B

Directional control valves for standard applications
 Tiger 2000

2.2

Solenoid/pneumatic valves, Tiger 2000

Accessories



Manifold strip

PAL-...-B

Material:

Anodised aluminium

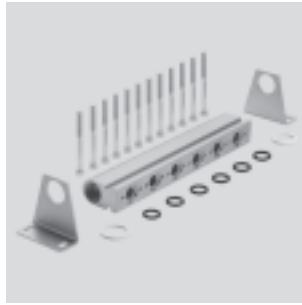

Directional control valves for standard applications
Tiger 2000

2.2

Dimensions

Download CAD data → www.festo.com/en/engineering

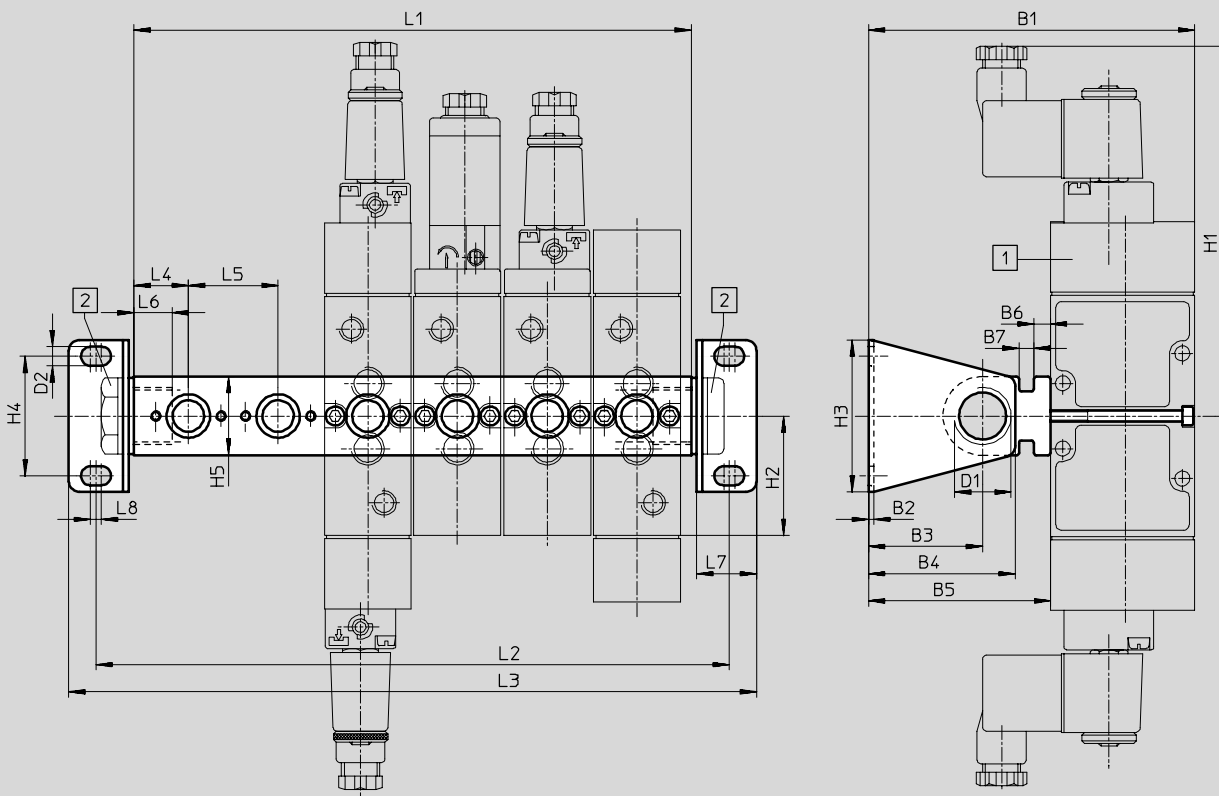

1 The caps on all valves can be repositioned by 180°

2 Blanking plugs and reducing nipples are not included in the scope of delivery

→ Volume 3

Type	B1	B2	B3	B4	B5	B6	B7	D1	D2	H1	H2	H3	H4	L4	L5	L6	L7	L8
PAL-1/8-...	104	2	33.5	44.5	57	5	5.5	G3/8	5.2	130	38.5	44	32	18	27	12	20	4
PAL-1/4-...	120	2	42	54	67	6.1	5.5	G1/2	7	136	44	56	44	20	33	14	22	4
PAL-3/8-...	176	3	75	93	106	4	14	G3/4	9	147	50	80	60	25	41	17	30	5

Solenoid/pneumatic valves, Tiger 2000

Accessories

FESTO

Dimensions and ordering data						
Number of valve ports	L1	L2	L3	Weight [g]	Part No.	Type
Pneumatic connection G$\frac{1}{8}$						
2	63	89	107	150	30 552	PAL-$\frac{1}{8}$-2-B
3	90	116	134	190	30 553	PAL-$\frac{1}{8}$-3-B
4	117	143	161	230	30 554	PAL-$\frac{1}{8}$-4-B
5	144	170	188	260	30 555	PAL-$\frac{1}{8}$-5-B
6	171	197	215	290	30 556	PAL-$\frac{1}{8}$-6-B
7	198	224	242	340	30 557	PAL-$\frac{1}{8}$-7-B
8	225	251	269	370	30 558	PAL-$\frac{1}{8}$-8-B
9	252	278	296	410	30 559	PAL-$\frac{1}{8}$-9-B
10	279	305	323	450	30 560	PAL-$\frac{1}{8}$-10-B
Pneumatic connection G$\frac{1}{4}$						
2	73	101	121	230	30 280	PAL-$\frac{1}{4}$-2-B
3	106	134	154	290	30 281	PAL-$\frac{1}{4}$-3-B
4	139	167	187	350	30 282	PAL-$\frac{1}{4}$-4-B
5	172	200	220	420	30 283	PAL-$\frac{1}{4}$-5-B
6	205	233	253	480	30 284	PAL-$\frac{1}{4}$-6-B
7	238	266	286	540	30 285	PAL-$\frac{1}{4}$-7-B
8	271	299	319	600	30 286	PAL-$\frac{1}{4}$-8-B
9	304	322	352	660	30 287	PAL-$\frac{1}{4}$-9-B
10	337	365	385	730	30 288	PAL-$\frac{1}{4}$-10-B
Pneumatic connection G$\frac{3}{8}$						
2	91	127	155	510	30 692	PAL-$\frac{3}{8}$-2-B
3	132	168	196	610	30 693	PAL-$\frac{3}{8}$-3-B
4	173	209	237	720	30 694	PAL-$\frac{3}{8}$-4-B
5	214	250	278	830	30 695	PAL-$\frac{3}{8}$-5-B
6	255	291	319	960	30 696	PAL-$\frac{3}{8}$-6-B
7	296	332	360	1060	30 697	PAL-$\frac{3}{8}$-7-B
8	337	373	401	1160	30 698	PAL-$\frac{3}{8}$-8-B
9	378	414	442	1260	30 699	PAL-$\frac{3}{8}$-9-B
10	419	455	483	1360	30 680	PAL-$\frac{3}{8}$-10-B

Directional control valves for standard applications
Tiger 2000

2.2

Solenoid/pneumatic valves, Tiger 2000

Accessories



Manifold
PRS

Material:
Anodised aluminium



Directional control valves for standard applications
Tiger 2000

2.2

Dimensions

Download CAD data → www.festo.com/en/engineering

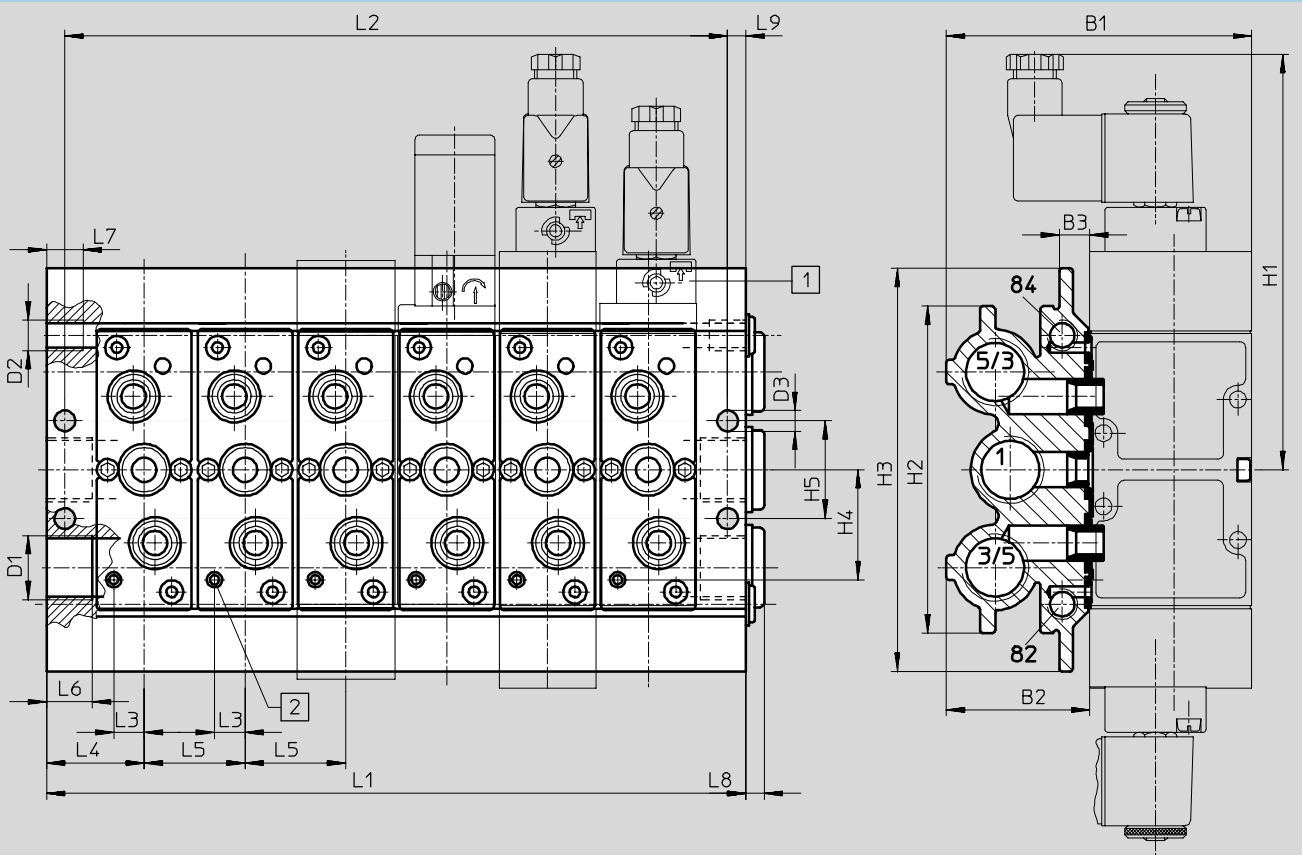

1 The caps on all valves can be repositioned by 180°

2 Hole for dowel pin to DIN 7346
Ø 3 mm

Type	B1	B2	B3	D1	D2	D3	H1	H2	H3	H4	H5	L3	L4	L5	L6	L7	L8	L9
PRS-1/8-...	93	45.5	11.2	G3/8	G1/8	6.8	130	95	120	27	27.5	9.4	25.5	27	14	8	5	6
PRS-1/4-...	100	47	10	G1/2	G1/8	6.8	136	107	132	36	32	10	32	33	15	12	6	9
PRS-3/8-...	131	60.5	12.5	G3/4	G1/8	9	147	128	153	44	44	15.2	36.5	41	16	12	6	7.5

Solenoid/pneumatic valves, Tiger 2000

Accessories

FESTO

Dimensions and ordering data					
Number of valve ports	L1	L2	Weight [g]	Part No.	Type
Pneumatic connection G $\frac{1}{8}$					
2	78	66	700	30 542	PRS- $\frac{1}{8}$ -2-BB
3	105	93	920	30 543	PRS- $\frac{1}{8}$ -3-BB
4	132	120	1150	30 544	PRS- $\frac{1}{8}$ -4-BB
5	159	147	1320	30 545	PRS- $\frac{1}{8}$ -5-BB
6	186	174	1520	30 546	PRS- $\frac{1}{8}$ -6-BB
7	213	201	1750	30 547	PRS- $\frac{1}{8}$ -7-BB
8	240	228	2010	30 548	PRS- $\frac{1}{8}$ -8-BB
9	267	255	2200	30 549	PRS- $\frac{1}{8}$ -9-BB
10	294	282	2400	30 550	PRS- $\frac{1}{8}$ -10-BB
Pneumatic connection G $\frac{1}{4}$					
2	97	85	1050	15 861	PRS- $\frac{1}{4}$ -2-B
3	130	118	1310	15 862	PRS- $\frac{1}{4}$ -3-B
4	163	151	1610	15 863	PRS- $\frac{1}{4}$ -4-B
5	196	184	1900	15 864	PRS- $\frac{1}{4}$ -5-B
6	229	217	2200	15 865	PRS- $\frac{1}{4}$ -6-B
7	262	250	2500	15 866	PRS- $\frac{1}{4}$ -7-B
8	259	283	2800	15 867	PRS- $\frac{1}{4}$ -8-B
9	328	316	3100	15 868	PRS- $\frac{1}{4}$ -9-B
10	361	349	3360	30 289	PRS- $\frac{1}{4}$ -10-B
Pneumatic connection G $\frac{3}{8}$					
2	114	99	1600	30 682	PRS- $\frac{3}{8}$ -2-B
3	155	140	2100	30 683	PRS- $\frac{3}{8}$ -3-B
4	196	181	2630	30 684	PRS- $\frac{3}{8}$ -4-B
5	237	222	3100	30 685	PRS- $\frac{3}{8}$ -5-B
6	278	263	3500	30 686	PRS- $\frac{3}{8}$ -6-B
8	360	345	4620	30 688	PRS- $\frac{3}{8}$ -8-B
10	442	427	5600	30 680	PRS- $\frac{3}{8}$ -10-B

Directional control valves for standard applications
Tiger 2000

2.2

Solenoid/pneumatic valves, Tiger 2000

Accessories



Directional control valves for standard applications
Tiger 2000

2.2

Blanking plate for vacant positions PRSB

Material:
Die-cast aluminium



Ordering data			
Pneumatic connection	Weight [g]	Part No.	Type
G $\frac{1}{8}$	33	15 909	PRBS- $\frac{1}{8}$ -B
G $\frac{1}{4}$	40	30 666	PRSB- $\frac{1}{4}$ -B
G $\frac{3}{8}$	72	30 681	PRSB- $\frac{3}{8}$ -B

Blanking plate for vacant positions PALB

Material:
Steel



Ordering data			
Pneumatic connection	Weight [g]	Part No.	Type
G $\frac{1}{8}$	14	30 903	PALB- $\frac{1}{8}$ -B
G $\frac{1}{4}$	22	30 904	PALB- $\frac{1}{4}$ -B
G $\frac{3}{8}$	32	30 905	PALB- $\frac{3}{8}$ -B

Sealing plug PRSV

Material:
Steel



Ordering data			
Pneumatic connection	Weight [g]	Part No.	Type
G $\frac{1}{8}$	18	160 997	PRSV- $\frac{1}{8}$ -B
G $\frac{1}{4}$	27	160 996	PRSV- $\frac{1}{4}$ -B

Solenoid/pneumatic valves, Tiger 2000



Accessories

Manual override tool

AHB

Material:
Polymer

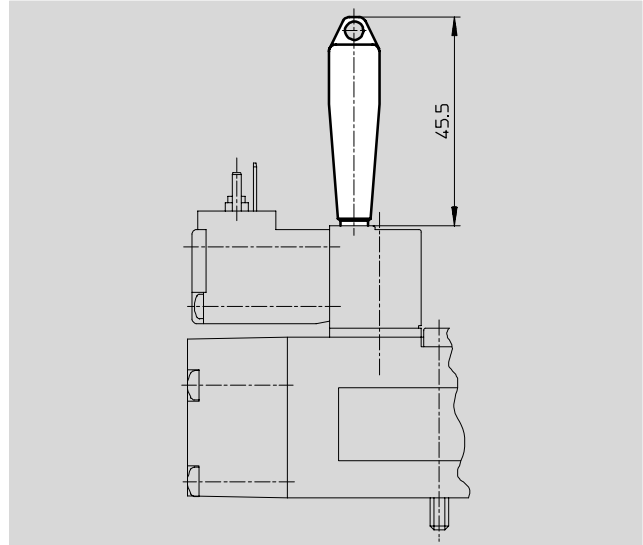

Ordering data				
For valve	Weight [g]	CRC ¹⁾	Part No.	Type
MFH/JMFH	10	2	157 651	AHB-MD/MF/MV

1) Corrosion resistance class 2 according to Festo standard 940 070
Components requiring moderate corrosion resistance. Externally visible parts with primarily decorative surface requirements which are in direct contact with a surrounding industrial atmosphere or media such as cooling or lubricating agents.

Inscription labels

KMC/F/V-BZ-35X

Material:
Polymer

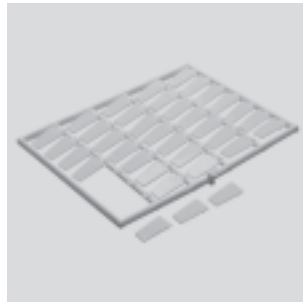

Ordering data				
	Weight [g]	Part No.	Type	
Inscription labels for valves (35 in frames included in scope of delivery)	20	33 362	KMC/F/V-BZ-35x	





Solenoid/pneumatic valves, Tiger 2000

Accessories

FESTO

Directional control valves for standard applications
Tiger 2000

2.2

Ordering data		Part No.	Type
Push-in fittings QS			
		→	Volume 3
Silencers			
		→	Volume 3
Blanking plugs			
		→	Volume 3
Reducing nipples			
		→	Volume 3

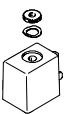
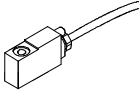

Ordering data – Solenoid coils			Technical data → 2 / 7.1-0	
	Voltage	Cable length [m]	Part No.	Type
F solenoid coils for valves MFH, JMFH				
	12 V DC	–	34 410	MSFG-12DC-OD
	24 V DC and 42 V AC, 50 ... 60 Hz	–	34 411	MSFG-24DC/42AC-OD
	42 V DC	–	34 413	MSFG-42DC-OD
	24 V AC	–	34 415	MSFG-24AC-OD
	48 V AC, 50 ... 60 Hz	–	34 418	MSPW-48AC-OD
	110 V AC, 50 ... 60 Hz and 120 V AC, 60 Hz	–	34 420	MSPW-110AC-OD
	230 V AC, 50 ... 60 Hz and 240 V AC, 60 Hz	–	34 422	MSPW-230AC-OD
	240 V AC, 50 ... 60 Hz	–	34 424	MSPW-240AC-OD
F solenoid coils for valves MFH, JMFH – Explosion-proof to EN 50 028				
	24 V DC	1	535 619	MSFG-24DC-EX
		5	535 621	MSFG-24DC-EX-K5
	24 V AC, 50 ... 60 Hz	1	535 623	MSPW-24AC-EX
		1	535 622	MSPW-110AC-EX
		1	535 620	MSPW-110AC-EX
		5	535 625	MSPW-110AC-EX-K5

 Core Range

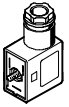

Solenoid/pneumatic valves, Tiger 2000

Accessories

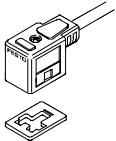

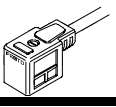
Ordering data – Plug sockets, plug sockets with cable for F solenoid coils					
	Voltage	Cable length [m]	Switching status display with LED	Part No.	Type
Plug socket without cable					Technical data → 2 / 7.2-10
	–	–	–	34 431	MSSD-F
Plug socket without cable with insulation displacement technology					Technical data → 2 / 7.2-10
	–	–	–	192 746	MSSD-F-S-M16
Plug socket with cable					Technical data → 2 / 7.3-21
	24 V DC	2.5	■	30 935	KMF-1-24DC-2,5-LED
		5	■	30 937	KMF-1-24DC-5-LED
		10	■	193 458	KMF-1-24DC-10-LED
	Up to 240 V	2.5	–	30 936	KMF-1-230AC-2,5
		5	–	30 938	KMF-1-230AC-5

Ordering data – Plug sockets, plug sockets with cable for V solenoid coils					
	Voltage	Cable length [m]	Switching status display with LED	Part No.	Type
Plug socket without cable					Technical data → 2 / 7.2-10
	–	–	–	33 295	MSSD-V
Plug socket with cable					Technical data → 2 / 7.3-21
	24 V DC	2.5	■	30 939	KMV-1-24DC-2,5-LED
		5	■	30 941	KMV-1-24DC-5-LED
		10	■	193 456	KMV-1-24-10-LED

Ordering data – Illuminating seal					Technical data → 2 / 7.4-1
	Voltage		Part No.	Type	
For F solenoid coils					
	12 ... 24 V DC		19 143	MF-LD-12-24DC	
	230 V DC/V AC		19 144	MF-LD-230AC	
For V solenoid coils					
	12 ... 24 V DC		35 558	MV-LD-12-24DC	

 Core Range