

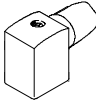





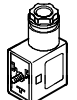
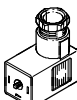
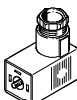

Plug sockets

Product range overview

Design	Type	For solenoid coil (valves with solenoid coil)											→ Page	
		D	E	EB	F	N1	N2	V	Y	Z	ZB	ZC		
	MSSD-F	-	-	-	■	-	-	-	-	-	-	-	-	2 / 7.2-11
	MSSD-C	■	-	-	-	■	-	-	-	-	-	-	-	2 / 7.2-12
	MSSD-V	-	-	-	-	-	-	■	-	-	-	-	-	2 / 7.2-13
	MSSD-E	-	■	-	-	-	-	-	-	-	-	-	-	2 / 7.2-14
	MSSD-EB	-	-	■	-	-	■	-	-	-	-	-	-	2 / 7.2-15
	MSSD-MY ¹	-	-	-	-	-	-	-	■	■	-	-	-	2 / 7.2-16
	MSSD-ZBZC	-	-	-	-	-	-	-	-	-	■	■	-	2 / 7.2-17

¹ - To be discontinued

 Note
Allocation of solenoid coils to valve types → 2 / 7.1-1

Design	Type	For miniature valves	For proportional valves	For valves with central plug		→ Page
		MHA1...-PI/ MHP1...-PI	MPPE/MPPES	ISO 15 407-1	ISO 5599-1	
	PCBC	■	-	-	-	2 / 7.2-18
	MPPE-3-B	-	■	-	-	2 / 7.2-19
	SEA-M12-4WD-PG7	-	-	■	■	2 / 7.2-20

Plug sockets MSSD-F

Technical data



Temperature range
-25 ... +90 °C

- For valves with F solenoid coils
- Cable connection using clamping screws or insulation displacement technology



General technical data		
Cable connection	Clamping screws	Insulation displacement technology
Perm. cable diameter [mm]	6 ... 8	5.5 ... 8
Wire cross section [mm ²]	Max. 1.5	0.5 ... 1
Number of pins	3	3
Cable conduit fitting	Pg9	-
Type of mounting	M3 central screw	M3 central screw
Connection frequency	-	10
Protection class to EN 60 529	IP65 (assembled)	IP67 (assembled)
Mounting position	Any	Any
Ambient temperature [°C]	-25 ... +90	-25 ... +90
Product weight [g]	17	35
Materials	Polymer	Polymer

Dimensions

[Download CAD data → www.festo.com/en/engineering](http://www.festo.com/en/engineering)

Clamping screws

2 Insert can be repositioned by 180°

Insulation displacement technology

2 Locknut M16x1
3 Connection side can be repositioned by 90°

With these plug sockets, instead of the cable being connected using individual clamping screws, the stranded wires are pressed into the patented insulation displacement contact when the screw is tightened.

- Strip the cable sheath
- Push it in
- Screw it in tightly
- And you're done!

Ordering data			
	Part No.	Type	
Cable connection			
	34 431	MSSD-F	Insulation displacement technology
	192 746	MSSD-F-S-M16	Clamping screws

Plug sockets MSSD-C

Technical data



Temperature range
-25 ... +90 °C

- For valves with D and N1 solenoid coils
- Cable connection using clamping screws or insulation displacement technology



General technical data			
Cable connection		Clamping screws	Insulation displacement technology
Perm. cable diameter	[mm]	6 ... 8	5.5 ... 8
Wire cross section	[mm ²]	Max. 1.5	0.5 ... 1
Number of pins		3	3
Cable conduit fitting		Pg9	-
Type of mounting		M3 central screw	M3 central screw
Connection frequency		-	10
Protection class to EN 60 529		IP65 (assembled)	IP67 (assembled)
Mounting position		Any	Any
Ambient temperature	[°C]	-25 ... +90	-25 ... +90
Product weight	[g]	22	38
Materials		Polymer	Polymer

Valve accessories
Plug sockets
7.2

Dimensions Download CAD data → www.festo.com/en/engineering

Clamping screws

Insulation displacement technology

With these plug sockets, instead of the cable being connected using individual clamping screws, the stranded wires are pressed into the patented insulation displacement contact when the screw is tightened.

- Strip the cable sheath
- Push it in
- Screw it in tightly
- And you're done!

1 Insert can be repositioned by 90°

2 Locknut M16x1

3 Connection side can be repositioned by 90°

Ordering data				
	Part No.	Type	Part No.	Type
Cable connection	Clamping screws		Insulation displacement technology	
	34 583	MSSD-C	192 748	MSSD-C-S-M16

Plug sockets MSSD-V

Technical data

FESTO

-  - Temperature range
-25 ... +90 °C

■ For valves with V solenoid coils



General technical data		
Perm. cable diameter	[mm]	6 ... 8
Wire cross section	[mm ²]	Max. 1.5
Number of pins		3
Cable conduit fitting		Pg9
Type of mounting		M3 central screw
Protection class to EN 60 529		IP65 (assembled)
Mounting position		Any
Ambient temperature	[°C]	-25 ... +90
Product weight	[g]	18
Materials		Polymer

Dimensions

Download CAD data → www.festo.com/en/engineering

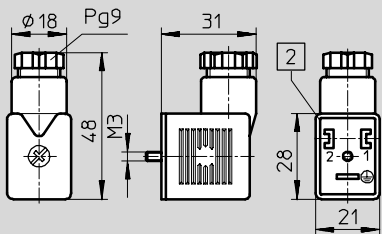

2 Insert can be repositioned by 180°

Ordering data			
	Description	Part No.	Type
	Plug socket for valves with V solenoid coils	33 295	MSSD-V

Plug sockets MSSD-E

Technical data



- - Temperature range
-25 ... +120°C

■ For valves with E solenoid coils



General technical data		
Perm. cable diameter	[mm]	6 ... 8
Wire cross section	[mm ²]	Max. 0.75
Number of pins		3
Cable conduit fitting		Pg7
Type of mounting		M3 central screw
Protection class to EN 60 529		IP65 (assembled)
Mounting position		Any
Ambient temperature	[°C]	-25 ... +120
Product weight	[g]	8
Materials		Polymer

Dimensions Download CAD data → www.festo.com/en/engineering

1 Insert can be repositioned by 90°

Ordering data			
	Description	Part No.	Type
	Plug socket for valves with E solenoid coils	14 098	MSSD-E

Plug sockets MSSD-EB

Technical data



Temperature range
-45 ... +90°C

For valves with EB and N2 solenoid coils



General technical data		
Cable connection	Clamping screws	Insulation displacement technology
Perm. cable diameter [mm]	6 ... 8	4 ... 6
Wire cross section [mm ²]	Max. 0.75	0.25 ... 0.5
Number of pins	3	3
Cable conduit fitting	Pg7	-
Type of mounting	M2.5 central screw	M2.5 central screw
Connection frequency	-	10
Protection class to EN 60 529	IP65 (assembled)	IP67 (assembled)
Mounting position	Any	Any
Ambient temperature [°C]	-45 ... +90	-25 ... +90
Product weight [g]	11	17
Materials	Polymer	Polymer

Dimensions

Download CAD data → www.festo.com/en/engineering

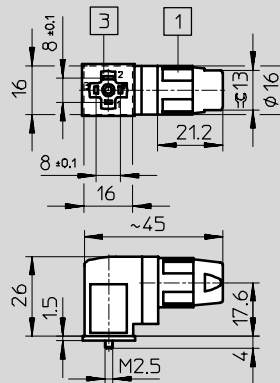
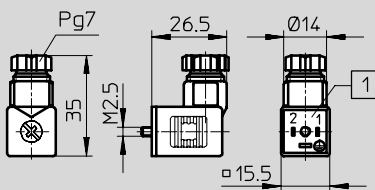

With these plug sockets, instead of the cable being connected using individual clamping screws, the stranded wires are pressed into the patented insulation displacement contact when the screw is tightened.

- Strip the cable sheath
- Push it in
- Screw it in tightly
- And you're done!

1 Insert can be repositioned by 90°

1 Locknut M14x1
3 Connection side can be repositioned by 90°

Ordering data			
	Part No.	Type	
Cable connection			Insulation displacement technology
	151 687	MSSD-EB	192 745 MSSD-EB-S-M14

Core Range

Do not use for new designs!
 - 1 - Type to be discontinued

FESTO

Plug sockets MSSD-MY

Technical data

-  Temperature range
-25 ... +80°C
- For valves with Y and Z solenoid coils



General technical data		
Perm. cable diameter	[mm]	6 ... 8
Wire cross section	[mm ²]	Max. 0.3
Number of pins		2
Type of mounting		Clip
Protection class to EN 60 529		IP00
Mounting position		Any
Ambient temperature	[°C]	-25 ... +80
Product weight	[g]	2
Materials		Polymer



Valve accessories
Plug sockets

7.2

Assembly instructions for MSSD-MY and MSSD-MY-C

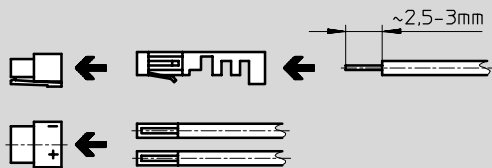
Download CAD data → www.festo.com/en/engineering



Ordering data			
	Description	Part No.	Type
	Plug socket for valves with Y and Z solenoid coils	34 345	MSSD-MY
	Crimp connectors for plug socket MSSD-MY	34 346	MSSD-MY-C

Plug sockets MSSD-ZBZC

Technical data



Temperature range
-10 ... +50°C

For valves with ZB and ZC solenoid coils



General technical data		
Wire cross section	[mm ²]	0.22 ... 0.34
Number of pins		2
Type of mounting		Self-tapping central screw
Protection class to EN 60 529		IP40 (assembled)
Mounting position		Any
Ambient temperature	[°C]	-10 ... +50
Product weight	[g]	11
Material		Polyamide

Dimensions Download CAD data → www.festo.com/en/engineering

- 1 Mounting screw
- 2 Inscription label
- 4 Connection pattern for ZB solenoid coil
- 5 Connection pattern for ZC solenoid coil

Ordering data			
	Description	Part No.	Type
	Plug socket for valves with ZB and ZC solenoid coils	185 521	MSSD-ZBZC

Core Range

Soldering base PCBC

Technical data



Temperature range
-40 ... +115°C

For mounting miniature valves
MHA1 and MHP1 on a PCB with
plug connection underneath (-PI)

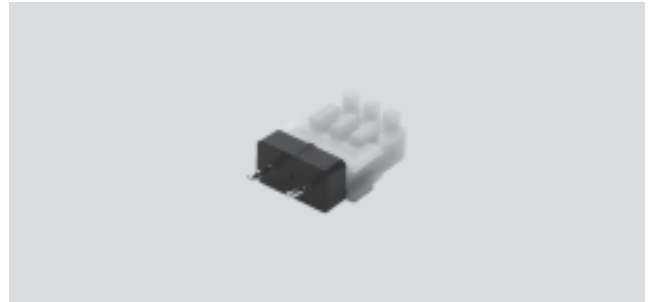

General technical data	
Number of pins	2
Type of mounting	Soldering base
Protection class to EN 60 529	IP40 (assembled)
Mounting position	Any
Ambient temperature [°C]	-40 ... +115
Product weight [g]	5
Materials	Polyamide

Valve accessories
Plug sockets

7.2

Dimensions Download CAD data → www.festo.com/en/engineering

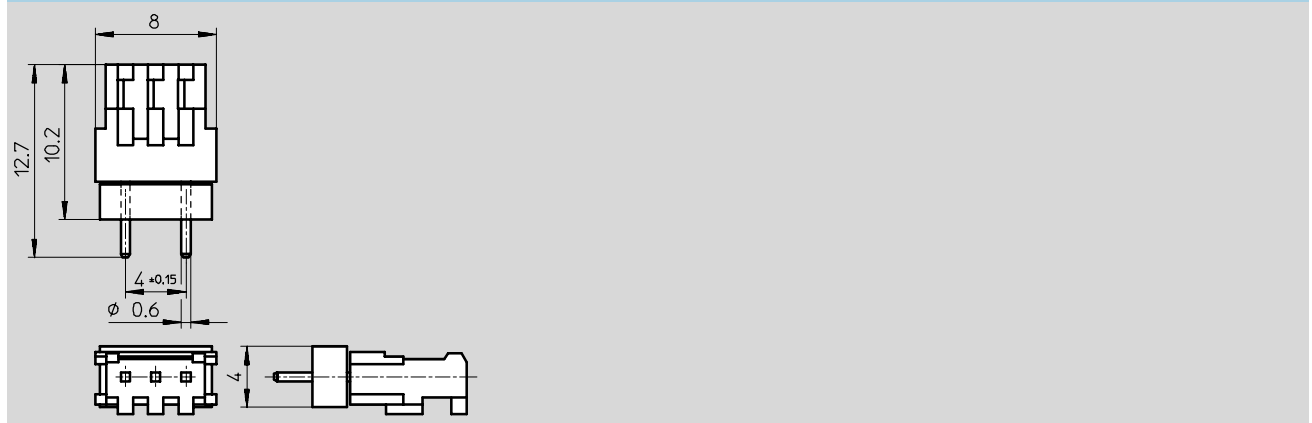

Ordering data				
	Description	Part No.	Type	PU ¹⁾
	Soldering base	197 261	PCBC-A-10	10
		197 262	PCBC-A-100	100

1) Packaging unit quantity

Plug sockets MPPE-3-B

Technical data



-  - Temperature range
-40 ... +85°C

■ For proportional pressure regulators MPPE and MPPES



General technical data		
Wire cross section	[mm ²]	Max. 0.75
Number of pins		8
Type of mounting		Knurled locknut M16x0.75
Mounting position		Any
Ambient temperature	[°C]	-40 ... +85
Product weight	[g]	42

Dimensions Download CAD data → www.festo.com/en/engineering

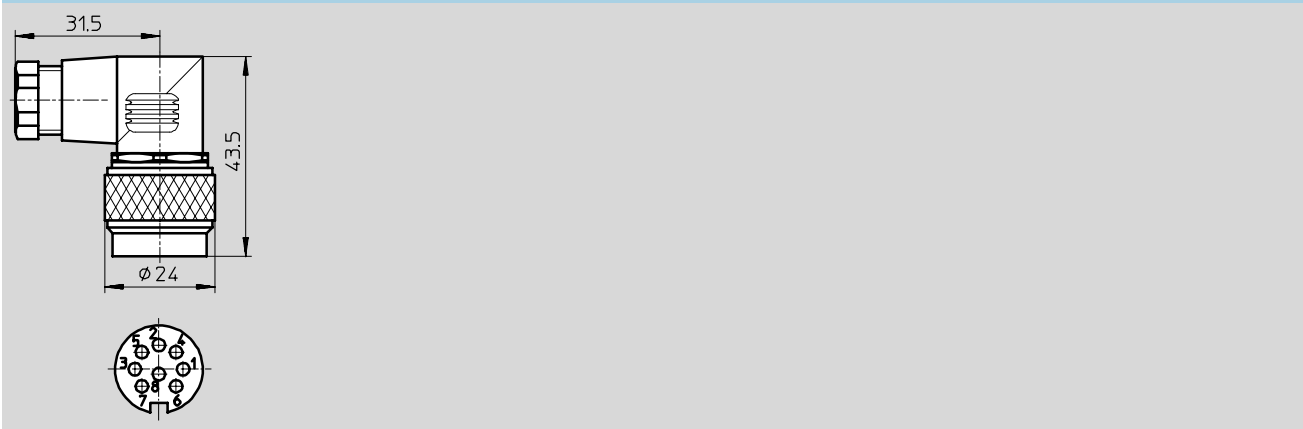

Ordering data		
	Description	Part No. Type
	Plug socket for proportional pressure regulators MPPE and MPPES	161 839 MPPE-3-B

Plug sockets SEA-M12-WD

Technical data



Temperature range
-40 ... +85°C

For valves to ISO 15 407-1
(VDMA 24 563) and ISO 5599-1
with central plug M12x1



General technical data		
Perm. cable diameter	[mm]	4 ... 6
Wire cross section	[mm ²]	Max. 0.75
Number of pins		4
Cable conduit fitting		Pg7
Type of mounting		Knurled locknut M12x1
Protection class to EN 60 529		IP67 (assembled)
Mounting position		Any
Ambient temperature	[°C]	-40 ... +85
Product weight	[g]	30
Material	Housing	Polybutylene terephthalate
	Contacts	Tin-coated bronze

Dimensions Download CAD data → www.festo.com/en/engineering

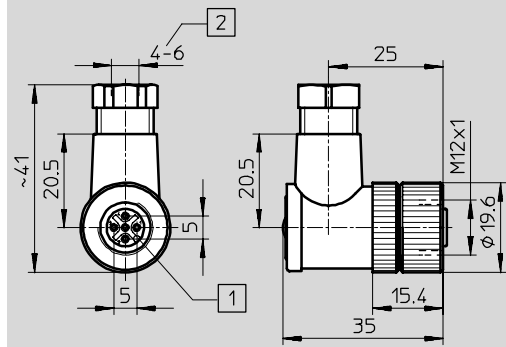

- 1 Contact set can be repositioned by 4x90°
- 2 Perm. cable diameter

Ordering data			
	Description	Part No.	Type
	Plug socket for valves to ISO 15 407-1 (VDMA 24 563) and ISO 5599-1 with central plug M12x1	185 498	SEA-M12-4WD-PG7