







- 3 thread types – M, R, and G thread
- 360° rotatable
- R-threads can be re-used up to five times.

Self-closing/rotary push-in fittings QS, Quick Star

Key features



| Application | Simply "plug and work" | Reliably connected | Captive seal |
|--|--|---|---|
|  <p>Effortless selection of the right fitting. Quick Star offers a secure solution for every connection. The convenient push-in fitting system includes well over 1000 types of standard and function fittings.</p> |  <p>The stainless steel retaining ring within the fitting holds the tubing securely without damaging its surface. Vibration and pressure surges are safely absorbed. The tubing can be detached easily by pressing down the blue release ring. For your convenience, the appropriate outside tubing diameter is marked on the release ring.</p> |  <p>A nitrile rubber sealing ring guarantees a perfect seal between standard OD tubing and the body of the fitting. Standard tubing is suitable for use with compressed air and vacuum.</p> |  <p>All of the brass components included in Festo's push-in fittings are nickel plated and are thus highly resistant to corrosion. The tapered ISO R threads have a self-sealing PTFE coating, which allows the fitting to be re-used up to five times without the need for additional sealing components.</p> |

| 360° rotatable | 360° rotatable, with ball bearing |
|--|---|
|  <p>Alignment is performed during assembly. Tube movement is compensated during use.</p> |  <p>Permits rotating motion of up to 500 rpm during use.</p> |

Which fitting fits which thread?

Metric thread

- Cylindrical metric thread is comparable with G-thread
- Sealing is guaranteed by a clip-on O-ring

G thread

- to DIN ISO 228-1**
- Shorter thread
 - Constant installation depth
 - Replaceable sealing ring
 - Sealing at front
 - Can be re-used a number of times thanks to replaceable sealing ring

R thread

- to DIN 2999-1 und ISO 7/1**
- Self-sealing thread
 - Sealing on the threads
 - No additional sealing surface required
 - Smaller installation dimensions since there is no need for a rebate for the sealing surface
 - Can be re-used up to five times

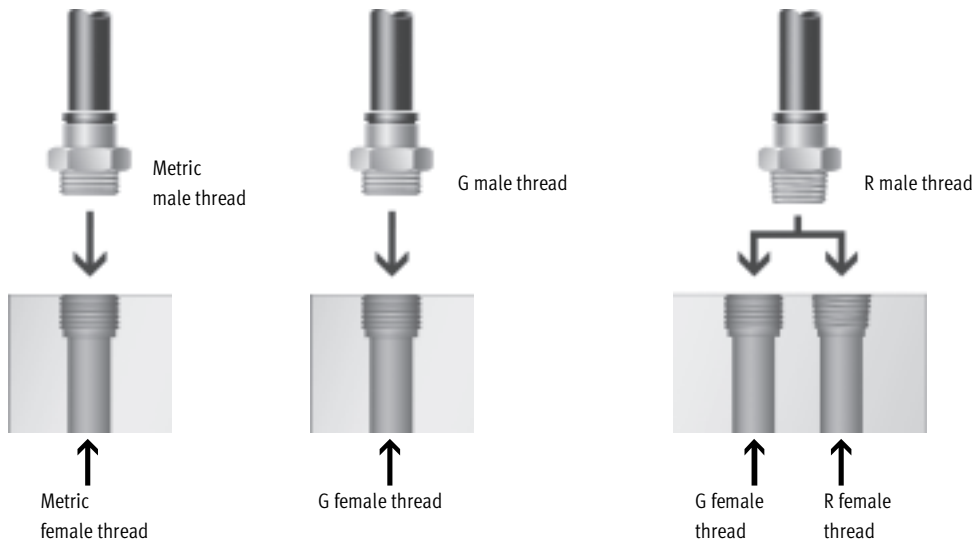

Self-closing/rotary push-in fittings QS, Quick Star

Technical data

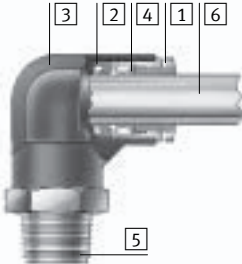
| Materials | | |
|---|---------------------------------|---|
| Sectional view | | |
|  | Standard QS | |
| | 1 Release ring | Polycarbonate |
| | 2 Flexible sleeve | Nitrile rubber |
| | 3 Housing | Steel Polybuteneterephthalate Nickel plated brass Anodised aluminium |
| | 4 Tube clamping segment | Brass Stainless steel |
| | 5 Threaded coupling | Nickel plated brass PTFE sealing compound |
| | 6 Plastic tubing, standard O.D. | PAN PUN PUN-H PUN-E |

| Tubing insertion depth | | | | | | |
|---|------------------|---|----|----|----|----|
|  | Tubing O.D. [mm] | 4 | 6 | 8 | 10 | 12 |
| | Standard QS | | 15 | 17 | 18 | 21 |

| Operating and environmental conditions | | |
|--|--------------|---------------|
| | Standard QSK | Standard QSR |
| Operating pressure [bar] | 0 ... +10 | -0.95 ... +10 |
| Operating temperature [°C] | 0 ... 60 | |
| Corrosion resistance CRC ¹⁾ | 1 | |







1) Corrosion resistance class 1 according to Festo standard 940 070
Components requiring low corrosion resistance. Transport and storage protection. Parts that do not have primarily decorative surface requirements, e.g. in internal areas that are not visible or behind covers.

| Possible push-in fitting/tubing combinations | | | | | |
|--|------------------|---|---|----|----|
| Thread | Tubing O.D. [mm] | | | | |
| | 4 | 6 | 8 | 10 | 12 |
| M5 | ■ | | - | - | - |
| R1/8 | | ■ | | | - |
| R1/4 | | | ■ | | |
| R3/8 | - | | | ■ | |
| R1/2 | - | - | - | | ■ |
| G1/8 | | ■ | | - | - |
| G1/4 | - | | ■ | | |
| G3/8 | - | - | | ■ | |
| G1/2 | - | - | - | - | ■ |

Possible thread/tubing O.D. combinations
 Optimum thread/tubing O.D. combinations (with regard to flow)

Self-closing/rotary push-in fittings QS, Quick Star

Product range overview

| Shape | Design | Type | Connection D1 | | | | Connection D2 | | → Page |
|--|--|------|---------------|----------|-----------|-------------|---------------|-----------|--------|
| | | | M thread | R thread | G thread | Tubing O.D. | Tubing O.D. | | |
| Straight | Self-closing push-in fitting – Male thread with external hex | | | | | | | | |
| |  | QSK | M5 | – | – | – | 4, 6 | 3 / 5.6-5 | |
| | | | – | R1/8 | G1/8 | | 4, 6, 8 | | |
| | | | – | R1/4 | G1/4 | | 6, 8, 10 | | |
| | | | – | R3/8 | G3/8 | | 8, 10, 12 | | |
| | | | – | R1/2 | G1/2 | | 12 | | |
| | Self-closing push-in connector | | | | | | | | |
| |  | QSK | – | – | – | 4 | – | 3 / 5.6-6 | |
| | | | – | – | – | 6 | | | |
| | | | – | – | – | 8 | | | |
| | | | – | – | – | 10 | | | |
| | | | – | – | – | 12 | | | |
| | Push-in bulkhead connector | | | | | | | | |
| |  | QSSK | – | – | – | 4 | – | 3 / 5.6-7 | |
| | | | – | – | – | 6 | | | |
| – | | | – | – | 8 | | | | |
| – | | | – | – | 10 | | | | |
| – | | | – | – | 12 | | | | |
| Rotary push-in fitting, rotatable 360° via ball bearing – Male thread with external hex | | | | | | | | | |
|  | QSR | M5 | – | – | – | 4, 6 | 3 / 5.6-10 | | |
| | | – | R1/8 | G1/8 | | 4, 6, 8 | | | |
| | | – | R1/4 | G1/4 | | 6, 8 | | | |
| | | – | R3/8 | G3/8 | | 8, 10, 12 | | | |
| | | – | R1/2 | G1/2 | | 12 | | | |
| L-shape | Self-closing push-in L-fitting – can be turned 360° – Male thread with external hex | | | | | | | | |
| |  | QSKL | M5 | – | – | – | 4, 6 | 3 / 5.6-8 | |
| | | | – | R1/8 | G1/8 | | 4, 6, 8 | | |
| | | | – | R1/4 | G1/4 | | 6, 8, 10 | | |
| | | | – | R3/8 | G3/8 | | 8, 10, 12 | | |
| | | | – | R1/2 | G1/2 | | 12 | | |
| | Rotary push-in L-fitting, rotatable 360° via ball bearing – Male thread with external hex | | | | | | | | |
| |  | QSRL | M5 | – | – | – | 4, 6 | 3 / 5.6-9 | |
| | | | – | R1/8 | G1/8 | | 4, 6, 8 | | |
| | | | – | R1/4 | G1/4 | | 6, 8 | | |
| – | | | R3/8 | G3/8 | 8, 10, 12 | | | | |
| – | | | R1/2 | G1/2 | 12 | | | | |

Self-closing push-in fittings QSK, Quick Star

Technical data



Self-closing push-in fitting QSK

Male thread
with external hex



M thread

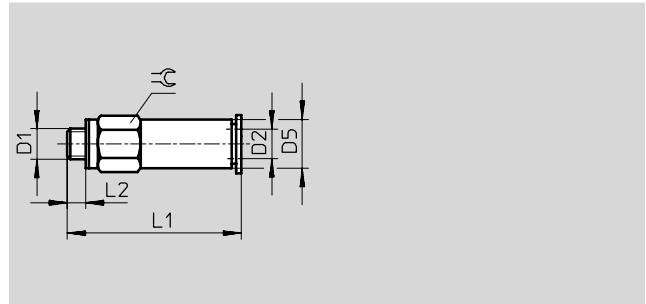

R thread

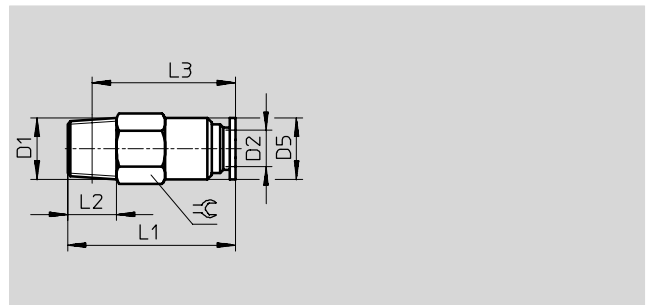

| Dimensions and ordering data | | | | | | | | | | |
|---------------------------------|--------------|-------------|---------|------|-----|------|----|----------|--------------------------------------|-----|
| Connection | Nominal size | Tubing O.D. | D5 ∅ | L1 | L2 | L3 | ⌀ | Part No. | Type | PU* |
| D1 | [mm] | D2 | | | | | | | | |
| Metric thread with sealing ring | | | | | | | | | | |
| M5 | 1.6 | 4 | 8 | 28.5 | 3.5 | – | 8 | 153 291 | QSK-M5-4 | 1 |
| | 2.3 | 6 | 10 | 32 | 3.5 | – | 10 | 153 292 | QSK-M5-6 | 1 |
| R thread | | | | | | | | | | |
| R ¹ / ₈ | 1.6 | 4 | 9 | 25.5 | 8 | 20 | 10 | 153 419 | QSK- ¹ / ₈ -4 | 1 |
| | 3 | 6 | 10 | 27.5 | 8 | 23 | 10 | 153 420 | QSK- ¹ / ₈ -6 | 1 |
| | 3.4 | 8 | 14 | 36 | 8 | 32 | 14 | 153 422 | QSK- ¹ / ₈ -8 | 1 |
| R ¹ / ₄ | 3 | 6 | 12 | 27.5 | 11 | 21 | 14 | 153 421 | QSK- ¹ / ₄ -6 | 1 |
| | 4.2 | 8 | 14 | 36 | 11 | 30 | 14 | 153 423 | QSK- ¹ / ₄ -8 | 1 |
| | 4.8 | 10 | 17 | 38.5 | 11 | 32.5 | 17 | 153 425 | QSK- ¹ / ₄ -10 | 1 |
| R ³ / ₈ | 4.5 | 8 | 15 | 36 | 12 | 29.5 | 17 | 153 424 | QSK- ³ / ₈ -8 | 1 |
| | 5.6 | 10 | 17 | 40 | 12 | 33.5 | 17 | 153 426 | QSK- ³ / ₈ -10 | 1 |
| | 6 | 12 | 21 | 46 | 12 | 39.5 | 21 | 153 427 | QSK- ³ / ₈ -12 | 1 |
| R ¹ / ₂ | 6.3 | 12 | 21 | 46 | 15 | 38 | 21 | 153 428 | QSK- ¹ / ₂ -12 | 1 |

* Packaging unit quantity

Core Range

Self-closing push-in fittings QSK, Quick Star

Technical data



Self-closing push-in fitting QSK

Male thread with external hex



G thread

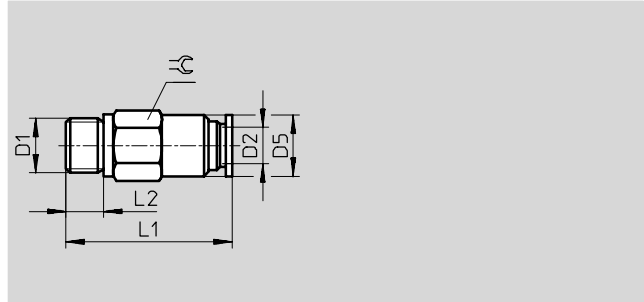

| Dimensions and ordering data | | | | | | | | | |
|-------------------------------|--------------|-------------|------|------|------|----|----------|---------------------------------------|-----|
| Connection | Nominal size | Tubing O.D. | D5 | L1 | L2 | ⌀ | Part No. | Type | PU* |
| D1 | [mm] | D2 | ∅ | | | | | | |
| G thread with sealing ring | | | | | | | | | |
| G ¹ / ₈ | 1.6 | 4 | 8.8 | 23 | 4.6 | 13 | 186 294 | QSK-G ¹ / ₈ -4 | 1 |
| | 3 | 6 | 10 | 25.7 | 4.6 | 13 | 186 295 | QSK-G ¹ / ₈ -6 | 1 |
| | 3.4 | 8 | 14 | 34.2 | 4.6 | 14 | 186 297 | QSK-G ¹ / ₈ -8 | 1 |
| G ¹ / ₄ | 3 | 6 | 12 | 24.7 | 6.6 | 17 | 186 296 | QSK-G ¹ / ₄ -6 | 1 |
| | 4.2 | 8 | 14 | 34.5 | 6.6 | 17 | 186 298 | QSK-G ¹ / ₄ -8 | 1 |
| | 4.8 | 10 | 17 | 36.8 | 6.6 | 17 | 186 300 | QSK-G ¹ / ₄ -10 | 1 |
| G ³ / ₈ | 4.5 | 8 | 15 | 34.5 | 8.1 | 19 | 186 299 | QSK-G ³ / ₈ -8 | 1 |
| | 5.6 | 10 | 17 | 38.3 | 8.1 | 19 | 186 301 | QSK-G ³ / ₈ -10 | 1 |
| | 6 | 12 | 20.8 | 44.3 | 8.1 | 21 | 186 302 | QSK-G ³ / ₈ -12 | 1 |
| G ¹ / ₂ | 6.3 | 12 | 20.8 | 44.4 | 11.1 | 24 | 186 303 | QSK-G ¹ / ₂ -12 | 1 |

* Packaging unit quantity

Self-closing push-in fittings QSK/QSSK, Quick Star

Technical data

Self-closing push-in connector QSK

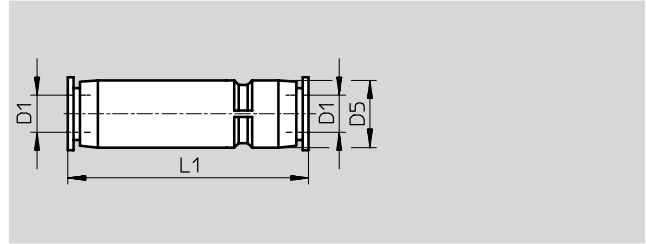





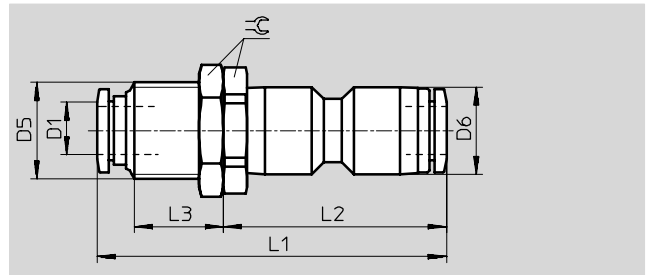

| Dimensions and ordering data | | | | | | | |
|------------------------------|----------------------|---------|------|---------------------|----------|--------|-----|
| Tubing O.D. D1 | Nominal size [mm] | D5 Ø | L1 | Weight/piece [g] | Part No. | Type | PU* |
| 4 | 1.6 | 8.5 | 36 | 3.5 | 153 439 | QSK-4 | 1 |
| 6 | 3 | 11 | 39.5 | 6 | 153 440 | QSK-6 | 1 |
| 8 | 4.5 | 14.5 | 54.5 | 16 | 153 441 | QSK-8 | 1 |
| 10 | 5.3 | 17.5 | 60.5 | 26 | 153 442 | QSK-10 | 1 |
| 12 | 6.2 | 21 | 70.5 | 40.5 | 153 443 | QSK-12 | 1 |

* Packaging unit quantity

Push-in bulkhead connector QSSK



| Dimensions and ordering data | | | | | | | | | | | | |
|------------------------------|----------------------|---------|---------|------|------|------|---|---------------------|----------|---------|---|-----|
| Tubing O.D. D1 | Nominal size [mm] | D5 Ø | D6 Ø | L1 | L2 | L3 |  | Weight/piece [g] | Part No. | Type | | PU* |
| 4 | 2.6 | M10x1 | 10 | 43.1 | 29.6 | 10 | 12 | 14 | 130 637 | QSSK-4 |  New | 10 |
| 6 | 4 | M12x1 | 12.5 | 47.6 | 34.2 | 9.9 | 14 | 20 | 130 638 | QSSK-6 |  New | 10 |
| 8 | 5.7 | M16x1 | 14.5 | 58.1 | 37.1 | 14.7 | 19 | 38 | 130 639 | QSSK-8 |  New | 10 |
| 10 | 7 | M20x1 | 17.5 | 66.5 | 43.4 | 16.2 | 24 | 68 | 130 640 | QSSK-10 |  New | 1 |
| 12 | 8 | M22x1 | 21 | 75.5 | 48.6 | 20.7 | 27 | 98 | 130 641 | QSSK-12 |  New | 1 |

* Packaging unit quantity

Self-closing push-in fittings QSKL, Quick Star

Technical data



Self-closing push-in L-fitting QSKL

360° rotatable
Male thread
with external hex

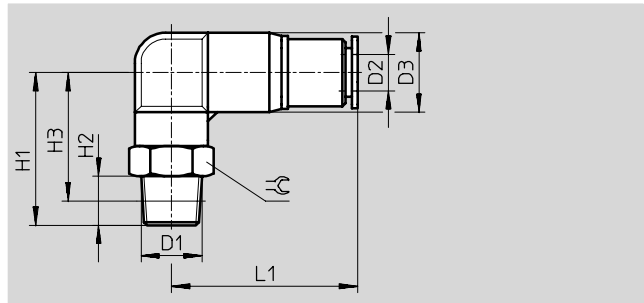
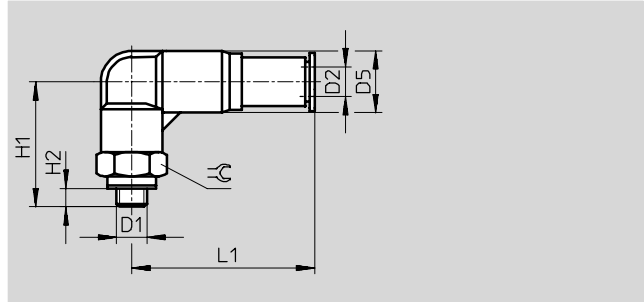

| Dimensions and ordering data | | | | | | | | | | | | |
|---------------------------------|--------------|-------------|---------|------|-----|------|------|----|-------------------------|----------|-------------------------|-----|
| Connection | Nominal size | Tubing O.D. | D5 ∅ | H1 | H2 | H3 | L1 | ⌀ | Weight/ piece [g] | Part No. | Type | PU* |
| D1 | [mm] | D2 | | | | | | | | | | |
| Metric thread with sealing ring | | | | | | | | | | | | |
| M5 | 1.5 | 4 | 10 | 20.5 | 3.5 | – | 30 | 10 | – | 153 294 | QSKL-M5-4 | 1 |
| | 2.3 | 6 | 12.5 | 22 | 3.5 | – | 30.5 | 12 | – | 153 295 | QSKL-M5-6 | 1 |
| R thread | | | | | | | | | | | | |
| R $\frac{1}{8}$ | 1.5 | 4 | 10 | 23.5 | 8 | 19.5 | 30.5 | 10 | 17 | 153 429 | QSKL- $\frac{1}{8}$ -4 | 1 |
| | 3 | 6 | 12.5 | 25 | 8 | 21 | 30.5 | 12 | 22 | 153 430 | QSKL- $\frac{1}{8}$ -6 | 1 |
| | 4.2 | 8 | 14.5 | 28 | 8 | 24 | 43 | 14 | 34 | 153 432 | QSKL- $\frac{1}{8}$ -8 | 1 |
| R $\frac{1}{4}$ | 3.2 | 6 | 12.5 | 28 | 11 | 22 | 30.5 | 14 | 29.5 | 153 431 | QSKL- $\frac{1}{4}$ -6 | 1 |
| | 4 | 8 | 14.5 | 31 | 11 | 25 | 43 | 14 | 40 | 153 433 | QSKL- $\frac{1}{4}$ -8 | 1 |
| | 5.2 | 10 | 17.5 | 36 | 11 | 30 | 49.5 | 17 | 58.5 | 153 435 | QSKL- $\frac{1}{4}$ -10 | 1 |
| R $\frac{3}{8}$ | 4.3 | 8 | 14.5 | 33 | 12 | 26.5 | 43 | 17 | 53 | 153 434 | QSKL- $\frac{3}{8}$ -8 | 1 |
| | 5.2 | 10 | 17.5 | 37 | 12 | 30.5 | 49.5 | 17 | 67 | 153 436 | QSKL- $\frac{3}{8}$ -10 | 1 |
| | 6.2 | 12 | 21 | 39 | 12 | 32.5 | 57.5 | 21 | 92.5 | 153 437 | QSKL- $\frac{3}{8}$ -12 | 1 |
| R $\frac{1}{2}$ | 6.2 | 12 | 21 | 42 | 15 | 34 | 57.5 | 21 | 107 | 153 438 | QSKL- $\frac{1}{2}$ -12 | 1 |

* Packaging unit quantity

Self-closing push-in fittings QSKL, Quick Star



Technical data

Self-closing push-in L-fitting QSKL-...

360° rotatable
Male thread
with external hex



G thread

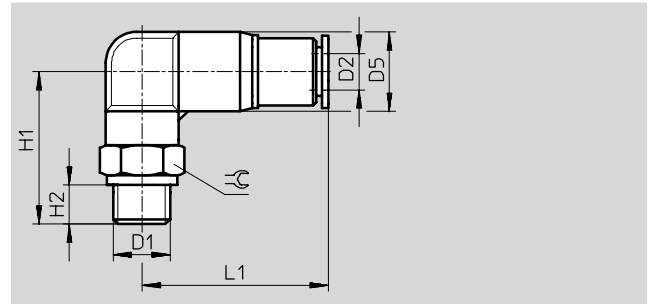

| Dimensions and ordering data | | | | | | | | | | |
|-------------------------------|--------------|-------------|------|------|------|------|----|----------|--|-----|
| Connection | Nominal size | Tubing O.D. | D5 | H1 | H2 | L1 | ⌀ | Part No. | Type | PU* |
| D1 | [mm] | D2 | ∅ | | | | | | | |
| G thread with sealing ring | | | | | | | | | | |
| G ¹ / ₈ | 1.5 | 4 | 10 | 22.8 | 4.6 | 30.3 | 13 | 186 304 | QSKL-G ¹ / ₈ -4 | 1 |
| | 3 | 6 | 12.5 | 23.5 | 4.6 | 30.4 | 13 | 186 305 | QSKL-G ¹ / ₈ -6 | 1 |
| | 4.2 | 8 | 14.5 | 26.5 | 4.6 | 43 | 14 | 186 307 | QSKL-G ¹ / ₈ -8 | 1 |
| G ¹ / ₄ | 3.2 | 6 | 12.5 | 26.5 | 6.6 | 30.4 | 17 | 186 306 | QSKL-G ¹ / ₄ -6 | 1 |
| | 4 | 8 | 14.5 | 29.5 | 6.6 | 43 | 17 | 186 308 | QSKL-G ¹ / ₄ -8 | 1 |
| | 5.2 | 10 | 17.5 | 33.5 | 6.6 | 49.3 | 17 | 186 310 | QSKL-G ¹ / ₄ -10 | 1 |
| G ³ / ₈ | 4.3 | 8 | 14.5 | 31.5 | 8.1 | 43 | 19 | 186 309 | QSKL-G ³ / ₈ -8 | 1 |
| | 5.2 | 10 | 17.5 | 35.5 | 8.1 | 49.3 | 19 | 186 311 | QSKL-G ³ / ₈ -10 | 1 |
| | 6.2 | 12 | 21 | 37.5 | 8.1 | 57.1 | 21 | 186 312 | QSKL-G ³ / ₈ -12 | 1 |
| G ¹ / ₂ | 6.2 | 12 | 21 | 42.5 | 11.1 | 57.1 | 22 | 186 313 | QSKL-G ¹ / ₂ -12 | 1 |

* Packaging unit quantity

Rotary push-in fittings QSR, Quick Star

Technical data



Rotary push-in fitting QSR

Rotatable 360°
via ball bearing
Male thread with
external hex



M thread

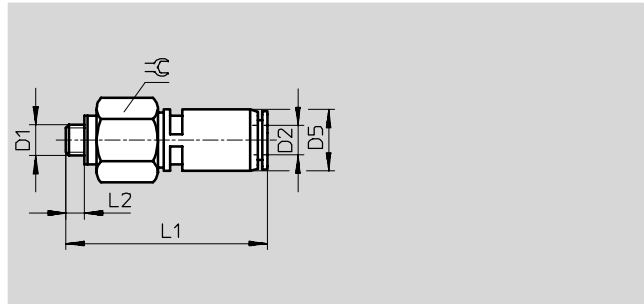

R thread

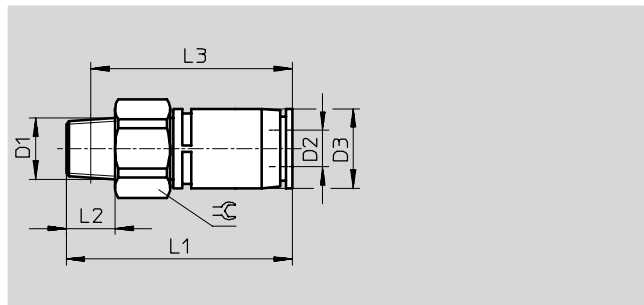

| Dimensions and ordering data | | | | | | | | | | | | |
|---------------------------------|--------------|-------------|------------------|------|------|-----|------|----|---------------|----------|------------|-----|
| Connection | Nominal size | Tubing O.D. | Rotational speed | D5 | L1 | L2 | L3 | ⌀ | Weight/ piece | Part No. | Type | PU* |
| D1 | [mm] | D2 | [rpm] | ∅ | | | | | [g] | | | |
| Metric thread with sealing ring | | | | | | | | | | | | |
| M5 | 1.9 | 4 | 500 | 10.5 | 33 | 3.5 | - | 12 | - | 153 526 | QSR-M5-4 | 1 |
| | 2.3 | 6 | 500 | 13 | 36.5 | 3.5 | - | 14 | - | 153 527 | QSR-M5-6 | 1 |
| R thread | | | | | | | | | | | | |
| R1/8 | 2.5 | 4 | 500 | 10.5 | 34.5 | 8 | 30.5 | 12 | 14 | 153 401 | QSR-1/8-4 | 1 |
| | 4 | 6 | 500 | 13 | 37 | 8 | 33 | 14 | 17 | 153 402 | QSR-1/8-6 | 1 |
| | 6 | 8 | 400 | 15 | 46 | 8 | 42 | 17 | 32 | 153 404 | QSR-1/8-8 | 1 |
| R1/4 | 4 | 6 | 500 | 13 | 39 | 11 | 33 | 14 | 23 | 153 403 | QSR-1/4-6 | 1 |
| | 6 | 8 | 400 | 15 | 45 | 11 | 39 | 17 | 31 | 153 405 | QSR-1/4-8 | 1 |
| R3/8 | 6 | 8 | 400 | 15 | 45 | 12 | 38.5 | 17 | 38 | 153 406 | QSR-3/8-8 | 1 |
| | 8 | 10 | 300 | 18 | 56.5 | 12 | 50 | 22 | 65 | 153 407 | QSR-3/8-10 | 1 |
| | 9.5 | 12 | 250 | 21 | 62.5 | 12 | 56 | 24 | 95 | 153 408 | QSR-3/8-12 | 1 |
| R1/2 | 9.5 | 12 | 250 | 21 | 62.5 | 15 | 54.5 | 24 | 101 | 153 409 | QSR-1/2-12 | 1 |

* Packaging unit quantity

Rotary push-in fittings QSR, Quick Star

Technical data



Rotary push-in fitting QSR

Rotatable 360°
via ball bearing
for plastic tubing
with standard O.D.



G thread

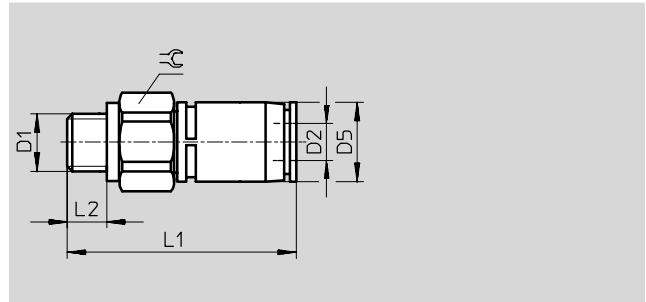

| Dimensions and ordering data | | | | | | | | | | |
|-------------------------------|--------------|-------------|------------------|------|------|------|----|----------------|--|----------|
| Connection | Nominal size | Tubing O.D. | Rotational speed | D5 | L1 | L2 | ⌀ | Part No. | Type | PU* |
| D1 | [mm] | D2 | [rpm] | ∅ | | | | | | |
| G thread with sealing ring | | | | | | | | | | |
| G ¹ / ₈ | 2.5 | 4 | 500 | 10 | 32.6 | 4.6 | 13 | 186 276 | QSR-G¹/₈-4 | 1 |
| | 4 | 6 | 500 | 12.5 | 35.4 | 4.6 | 14 | 186 277 | QSR-G¹/₈-6 | 1 |
| | 6 | 8 | 400 | 14.5 | 43.8 | 4.6 | 17 | 186 279 | QSR-G¹/₈-8 | 1 |
| G ¹ / ₄ | 4 | 6 | 500 | 12.5 | 36.4 | 6.6 | 17 | 186 278 | QSR-G¹/₄-6 | 1 |
| | 6 | 8 | 400 | 14.5 | 41.8 | 6.6 | 17 | 186 280 | QSR-G¹/₄-8 | 1 |
| G ³ / ₈ | 6 | 8 | 400 | 14.5 | 42.8 | 8.1 | 19 | 186 281 | QSR-G³/₈-8 | 1 |
| | 8 | 10 | 300 | 17.8 | 55.3 | 8.1 | 22 | 186 282 | QSR-G³/₈-10 | 1 |
| | 9.5 | 12 | 200 | 20.8 | 60.8 | 8.1 | 24 | 186 283 | QSR-G³/₈-12 | 1 |
| G ¹ / ₂ | 9.5 | 12 | 200 | 20.8 | 60.8 | 11.1 | 24 | 186 284 | QSR-G¹/₂-12 | 1 |

* Packaging unit quantity

Rotary push-in fittings QSRL, Quick Star

Technical data



Rotary push-in L-fitting QSRL

Rotatable 360°
via ball bearing
Male thread
with external hex



M thread

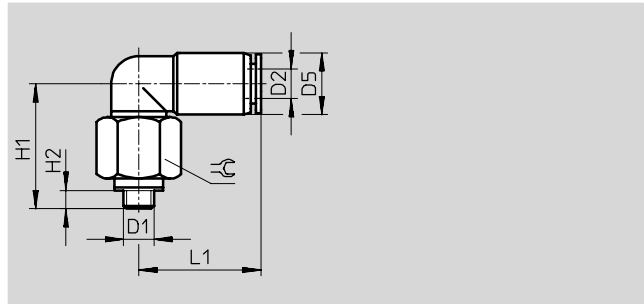

R thread

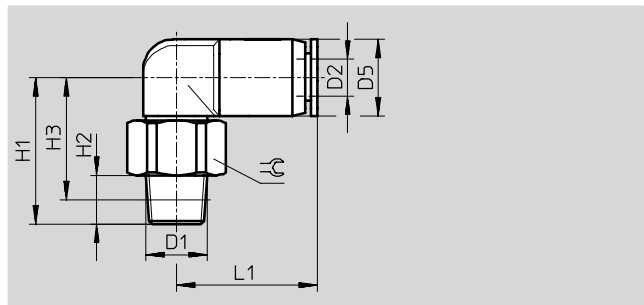

| Dimensions and ordering data | | | | | | | | | | | | |
|---------------------------------|--------------|-------------|------------------|------|------|-----|------|----|----|----------|-------------|-----|
| Connection | Nominal size | Tubing O.D. | Rotational speed | D5 | H1 | H2 | H3 | L1 | ⌀ | Part No. | Type | PU* |
| D1 | [mm] | D2 | [rpm] | ∅ | | | | | | | | |
| Metric thread with sealing ring | | | | | | | | | | | | |
| M5 | 1.5 | 4 | 500 | 10.5 | 20.5 | 3.5 | - | 20 | 12 | 153 529 | QSRL-M5-4 | 1 |
| | 1.9 | 6 | 500 | 13 | 23.5 | 3.5 | - | 23 | 14 | 153 530 | QSRL-M5-6 | 1 |
| R thread | | | | | | | | | | | | |
| R1/8 | 2.5 | 4 | 500 | 10 | 23 | 8 | 18 | 20 | 12 | 153 410 | QSRL-1/8-4 | 1 |
| | 4 | 6 | 500 | 12.5 | 24 | 8 | 20 | 23 | 14 | 153 411 | QSRL-1/8-6 | 1 |
| | 6 | 8 | 400 | 14.5 | 31.5 | 8 | 27.5 | 26 | 14 | 153 413 | QSRL-1/8-8 | 1 |
| R1/4 | 4 | 6 | 500 | 12.5 | 26 | 11 | 20 | 23 | 14 | 153 412 | QSRL-1/4-6 | 1 |
| | 6 | 8 | 400 | 14.5 | 30.5 | 11 | 24.5 | 26 | 17 | 153 414 | QSRL-1/4-8 | 1 |
| R3/8 | 6 | 8 | 400 | 14.5 | 30.5 | 12 | 24 | 26 | 17 | 153 415 | QSRL-3/8-8 | 1 |
| | 8 | 10 | 300 | 17.5 | 36 | 12 | 29.5 | 30 | 22 | 153 416 | QSRL-3/8-10 | 1 |
| | 9.5 | 12 | 250 | 21 | 41.5 | 12 | 35 | 33 | 24 | 153 417 | QSRL-3/8-12 | 1 |
| R1/2 | 9.5 | 12 | 250 | 21 | 41.5 | 15 | 33.5 | 33 | 24 | 153 418 | QSRL-1/2-12 | 1 |

* Packaging unit quantity

Rotary push-in fittings QSRL, Quick Star

Technical data



Rotary push-in L-fitting QSRL

Rotatable 360°
via ball bearing
Male thread
with external hex



G thread

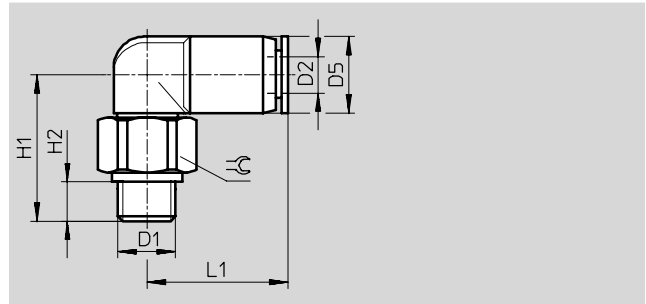

| Dimensions and ordering data | | | | | | | | | | | |
|-------------------------------|--------------|-------------|------------------|------|------|------|------|----|----------------|---|----------|
| Connection | Nominal size | Tubing O.D. | Rotational speed | D5 | H1 | H2 | L1 | ≅ | Part No. | Type | PU* |
| D1 | [mm] | D2 | [rpm] | ∅ | | | | | | | |
| G thread with sealing ring | | | | | | | | | | | |
| G ¹ / ₈ | 1.5 | 4 | 500 | 10 | 20.5 | 4.6 | 19.7 | 13 | 186 285 | QSRL-G¹/₈-4 | 1 |
| | 3 | 6 | 500 | 12.5 | 22.4 | 4.6 | 22.8 | 14 | 186 286 | QSRL-G¹/₈-6 | 1 |
| | 4.2 | 8 | 400 | 14.5 | 30 | 4.6 | 25.7 | 17 | 186 288 | QSRL-G¹/₈-8 | 1 |
| G ¹ / ₄ | 3.2 | 6 | 500 | 12.5 | 23.5 | 6.6 | 22.8 | 17 | 186 287 | QSRL-G¹/₄-6 | 1 |
| | 4 | 8 | 400 | 14.5 | 28 | 6.6 | 25.7 | 17 | 186 289 | QSRL-G¹/₄-8 | 1 |
| G ³ / ₈ | 4.3 | 8 | 400 | 14.5 | 29 | 8.1 | 25.7 | 19 | 186 290 | QSRL-G³/₈-8 | 1 |
| | 5.2 | 10 | 300 | 17.5 | 34.7 | 8.1 | 29.5 | 22 | 186 291 | QSRL-G³/₈-10 | 1 |
| | 6.2 | 12 | 200 | 21 | 40 | 8.1 | 32.7 | 24 | 186 292 | QSRL-G³/₈-12 | 1 |
| G ¹ / ₂ | 6.2 | 12 | 200 | 21 | 40 | 11.1 | 32.7 | 24 | 186 293 | QSRL-G¹/₂-12 | 1 |

* Packaging unit quantity