





Illuminating seals

Product range overview

Design	Type	For plug socket	For plug socket with cable	For solenoid coil (valves with solenoid coil)							→ Page
				D	E	EB	F	N1	N2	V	
	MF-LD	MSSD-F	KMF	-	-	-	■	-	-	-	2 / 7.4-3
	MC-LD	MSSD-C	KMC	■	-	-	-	■	-	-	2 / 7.4-3
	MV-LD	MSSD-V	KMV	-	-	-	-	-	-	■	2 / 7.4-3
	ME-LD	MSSD-E	KME	-	■	-	-	-	-	-	2 / 7.4-3
	MEB-LD	MSSD-EB	KMEB	-	-	■	-	-	■	-	2 / 7.4-3

Illuminating seals

Technical data



- - Temperature range
-25 ... +90°C

Illuminating seals are mounted between the plug socket and solenoid coil. They are illuminated yellow after power is switched on.



General technical data			M...-LD12-24DC	M...-LD230AC
Operating voltage range	D.C. voltage	[V DC]	12 ... 24	230 ±10%
	A.C. voltage	[V AC]	-	230 ±10%
Nominal power	D.C. voltage	[W]	0.25	1.2
	A.C. voltage	[VA]	-	1.2
Type of mounting	Central screw			
Tightening torque	[Nm]		Max. 0.6	
Mounting position	Any			
Protection class to EN 60 529	IP65 (assembled)			
Ambient temperature	[°C]		-25 ... +90	
Product weight	[g]		Approx. 5	
Material	Polyurethane			

Valve accessories
Illuminating seals

7.4

Installation of the illuminating seal

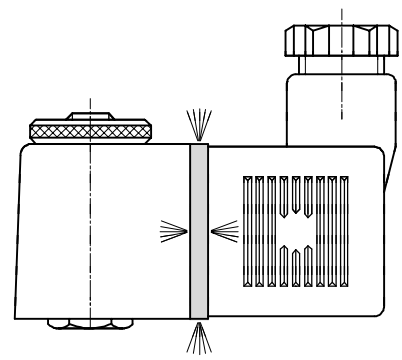

- - Note

The original seal must be removed before the illuminating seal is installed.
The sealing surface of the illuminating seal must point towards the plug socket, and the sealing rim towards the solenoid coil.

The illuminating seal is intended to be installed once. Reusing illuminating seals can impair their function.



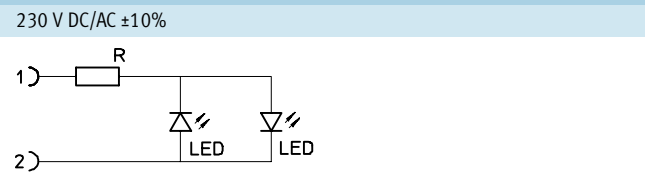
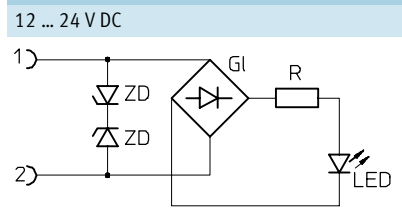

Circuit diagrams



Illuminating seals

Technical data

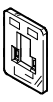

Ordering data				
	Operating voltage range		Part No.	Type
	[V DC]	[V AC]		
Illuminating seal for F solenoid coils				
	12 ... 24	–	19 143	MF-LD-12-24DC
	230 ±10%	230 ±10%	19 144	MF-LD-230AC
Illuminating seal for D and N1 solenoid coils				
	12 ... 24	–	19 145	MC-LD-12-24DC
	230 ±10%	230 ±10%	19 146	MC-LD-230AC
Illuminating seal for V solenoid coils				
	12 ... 24	–	35 558	MV-LD-12-24DC
	230 ±10%	230 ±10%	151 716	MV-LD-230AC
Illuminating seal for E solenoid coils				
	12 ... 24	–	19 141	ME-LD-12-24DC
Illuminating seal for EB solenoid coils				
	12 ... 24	–	151 717	MEB-LD-12-24DC
	230 ±10%	230 ±10%	151 718	MEB-LD-230AC

 Core Range