



- Modular valve terminal
- Programmable with integrated controller
- Open to all fieldbus protocols
- Modular electrical peripherals with digital and analogue I/Os
- Diagnosis using fieldbus
- Sturdy metal design

Modular electrical peripherals, for type 03/04

Key features

FESTO

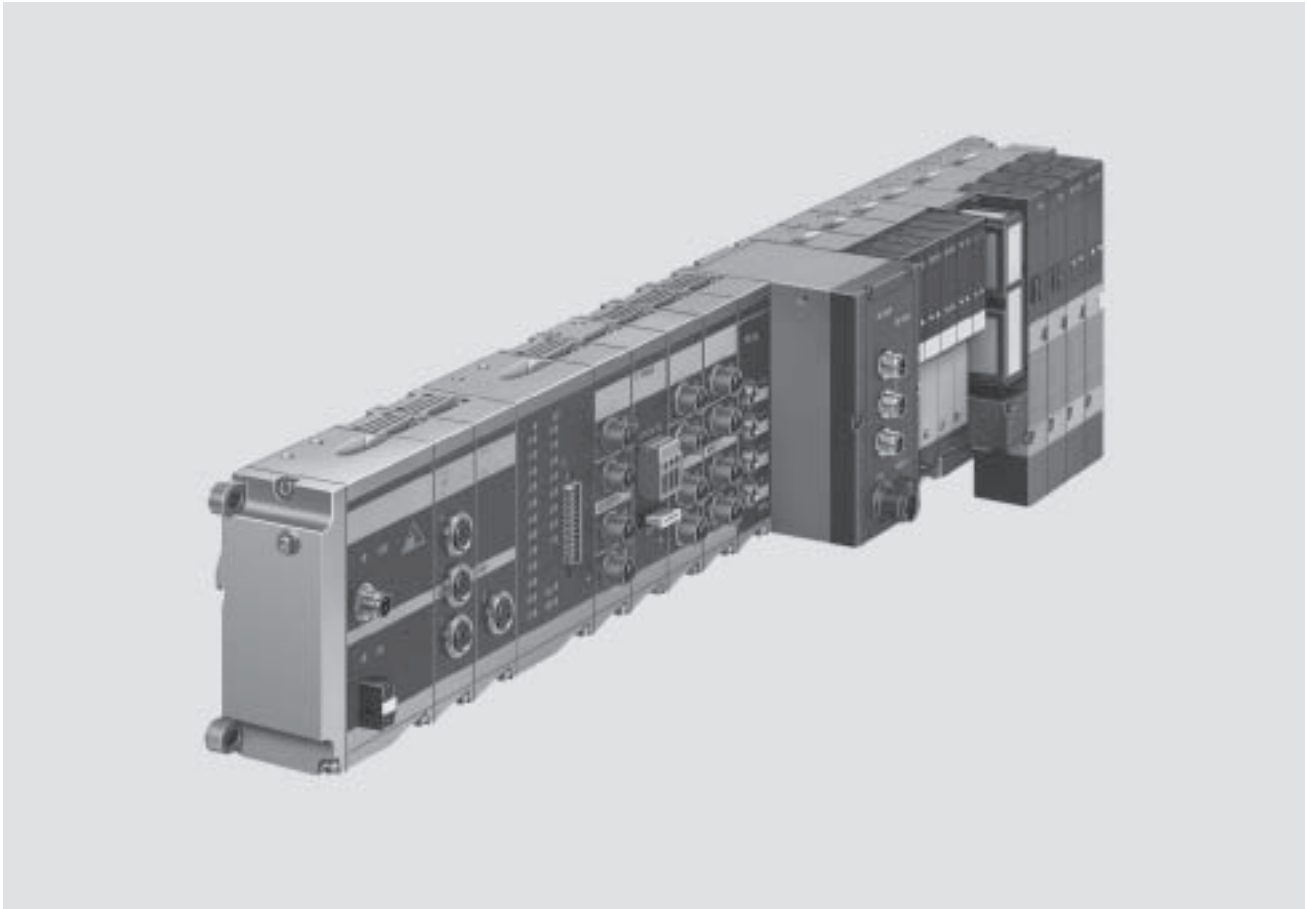

Innovative

- First modular valve terminal on the market with modular electrical peripherals
- Standardised from the individual midi valve up to multi-pin and fieldbus connections
- First programmable valve terminal with integrated controller
- Digital I/O modules, either PNP or NPN switching
- Analogue I/O in the field for short lines
- High-current outputs
- Special modules for control desks
- Interfaces for subordinate, decentralised installation systems
 - AS-interface master
 - CP module

Modular

- Modular system offering a range of configuration options
- Expandable up to 26 solenoid coils
- Conversions and extensions are possible at any time
- Connection blocks can be extended using 3 screws M4x14
- Modular electrical peripherals with digital and analogue I/Os
- High pressure range

Reliable

- Sturdy and durable metal components
 - I/O modules
 - Connection technology
 - Valves
 - Connection blocks
- Fast troubleshooting thanks to LEDs on the valves and I/O modules
- Diagnosis using fieldbus
- Pre-assembled cables for all I/O modules
- Reliability of service through replaceable valves and modules

Easy to assemble

- Ready to install unit, already assembled and tested
- Lower costs for selection, ordering, assembly and commissioning
- Secure wall mounting or via H-rail

Modular electrical peripherals, for type 03/04

Key features

Modular electrical peripherals for valve terminal type 03/04

Modular electrical peripherals provide the required control technology for type 03 (MIDI/MAXI) and type 04 (ISO) valve terminals. Together these components form the most comprehensive system range in intelligent pneumatics and also offer the advantage of a sturdy metal design.

As well as incorporating protection class IP65, the system also provides benefits through the sturdy design of its modules and connections. Individual modules are enclosed in metal housings with push-in fittings, and are made primarily of steel. The connections between the modules are protected by special seals and each connection point is secured using 3 robust M4x14 DIN 912 screws.

The main industrial fieldbuses are used for networking and control. Directly integrated programmable controllers (PLC) with fieldbus interface from Festo and Allen Bradley can also be used for actuation. The module also offers various actuation and connection options for machine control.

Ongoing further development and a worldwide service and consultation network round off the performance spectrum for this system.

Note
Use the menu-driven online configurator for modular electrical peripherals type 03/04 and valve terminal in the electronic catalogue or on our home page.

Type 03 with fieldbus connection

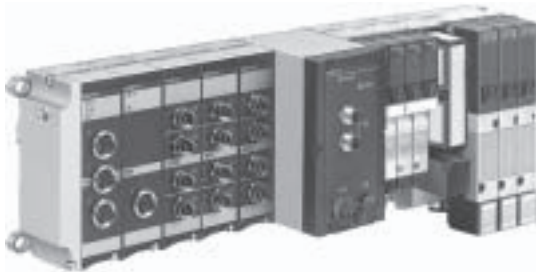

Type 03 with integrated programmable PLC

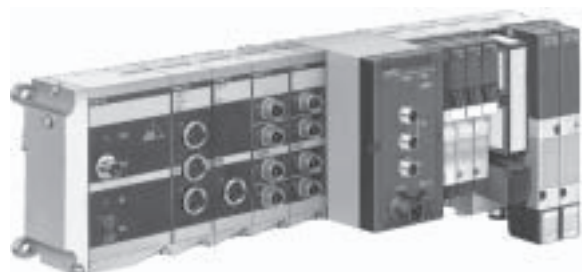

Type 04 with fieldbus connection

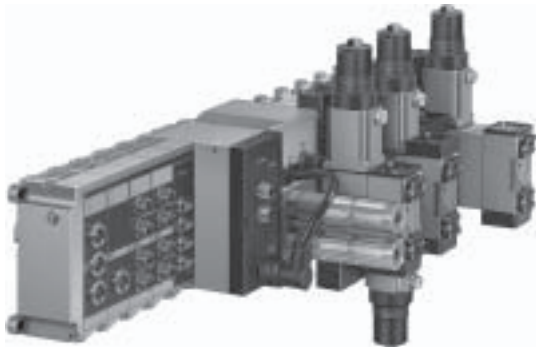

Type 04 with integrated programmable PLC

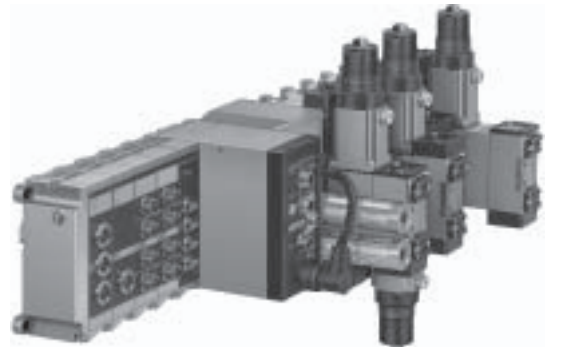

Ordering

Modular electrical peripherals type 03/04 and valve terminal are fully assembled according to your order specifications and individually tested. The finished valve terminal consists of the electrical peripherals including the required actuator and the selected components of the MIDI/MAXI or ISO modules.

Modular electrical peripherals type 03/04 with valve terminal are ordered using two separate order codes. One order code defines the modular electrical peripherals type 03/04, while the other specifies the pneumatic components of the valve terminal.

Modular electrical peripherals type 03/04 can naturally also be configured without a valve terminal as a remote I/O and can be used on a fieldbus or with an integrated controller. For this order, you only require the order code for the electrical peripherals.

The order lists for the modular electrical peripherals type 03/04 can be found in this chapter. For information on how to order the pneumatic components see:
 → 4 / 2.2-44 Valve terminal type 03
 → 4 / 1.1-2 Valve terminal type 04

Modular electrical peripherals, for type 03/04

Key features – General

FESTO

Performance characteristics

Control block, fieldbus connection, multi-pin connection

Optimising and extending applications:

- Modules for installation-saving connection using sturdy Sub-D plugs in IP65
- Low-cost connections to input/output stations and control units
- AS-interface master for connection to distributed inputs/outputs covering an extensive range, e.g. in conveyor systems
- CP modules for connecting decentralised CPV and CPA valve terminals
- Extensions and supplements can be added at any time

Easy mounting:

- On H-rail
- On mounting surface
- With covers in welding environments

Simple servicing and maintenance:

- LED display
- Manual override
- Clip-on inscription labels

Convenient diagnosis via fieldbus connection and integrated PLC:

- Status bits
- Diagnostic bits
- Integrated self-test

Input/output modules

Flexible for control systems thanks to an extensive range of connection nodes:

- Multi-pin connection
- Fieldbus connection
- AS-interface

Stand-alone solutions with integrated PLC (control block):

- From Festo
- From Allen Bradley

Electrical digital inputs/outputs:

- Max. 12 modules in conjunction with suitable nodes
- Inputs for 24 V DC sensors, PNP or NPN
- Outputs for small-load power consumers 24 V DC
- High-current outputs up to 2 A PNP/NPN, e.g. for hydraulic valves, can be connected directly to the valve terminal

Proportional pneumatics:

- Analogue modules optimised for proportional valves, e.g. for Festo MPYE and MPPES for regulating the force of a cylinder
- To detect, control/regulate universal variables (4 ... 20 mA or 0 ... 10 V) within the process – locally to IP65

Modular electrical peripherals, for type 03/04

Key features – General



Types of pneumatic valve terminals supported

Type 03 – MIDI/MAXI valve terminals

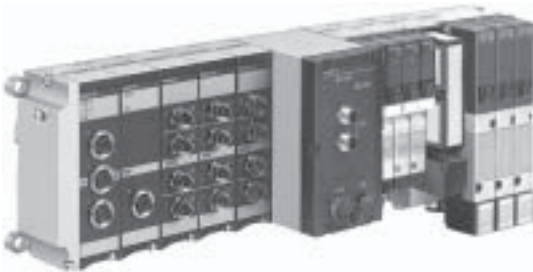

Type 04 – ISO valve terminals

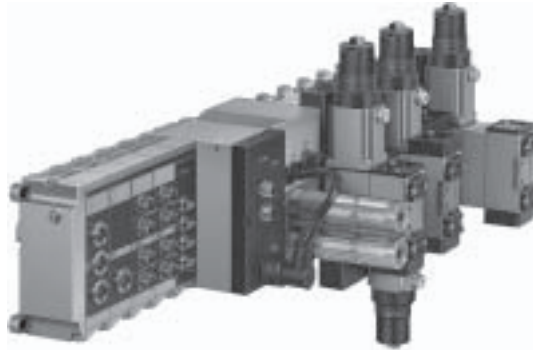

General functions of the bus nodes and control blocks

A bus node or control block is at the heart of the modular electrical peripheral system. They manage the communication connection to higher-order controllers and master interfaces and a PLC program with a full range of additional functions is executed directly in the control block. The power supply for the I/O modules and the sensors connected to them is provided by means of the bus node or control block, as is the load supply for the solenoid coils and the electronic outputs.

System monitoring and diagnosis are further important functions of the bus node or control block. The diagnostics are composed of three elements:

- Device-specific information displayed directly on the bus node or control block by means of LEDs.
- Device-specific status bits that are transferred to the control program via the network.
- Protocol-specific diagnoses.

The bus nodes or control blocks collect the most important diagnostic data in the status bits and transfer it to the higher-order controller as logical inputs.

Suitable further processing functions in the control program provide helpful information on the status of the power supply, short circuits and overload (with some of this information relating to specific modules or channels). Further protocol and node-specific diagnostic services are described in conjunction with the individual I/O modules, bus nodes and control blocks.

The control blocks are original controllers from Allen Bradley or Festo and are identical to systems with the original design in terms of both their function and their system and integration compatibility.

Modular electrical peripherals, for type 03/04

Key features – Electrical components



Supply voltage

The entire power supply for the system and the sensors and actuators connected to it is provided via an M18 mains plug.

The power supply for the electrical peripherals type 03 and 04 is split in two.

Pin 1 of the mains plug provides the sensor supply for the input modules and supplies the internal electronics of the individual modules.

The sensor supply is protected separately from the electronics supply in the node by means of a 2 A fuse. We recommend that pin 1 be additionally protected against short circuit/overload by means of a 3.15 A external fuse.

Pin 2 of the mains plug provides the load supply for solenoid coil actuation and the electrical 24 V DC outputs.

The load supply must be externally protected against short circuit and overload by means of a 10 A strong fuse.

The load voltage of the valves and electrical outputs can be disconnected separately. The common 0 V line is connected to pin 3. Pin 4 serves as an earth terminal.

With valve terminals of the type 04, the solenoid coils are protected by an additional fuse.

Example of circuit

Connection of a common 24 V power supply and the protective earth (type 03 used in the example)

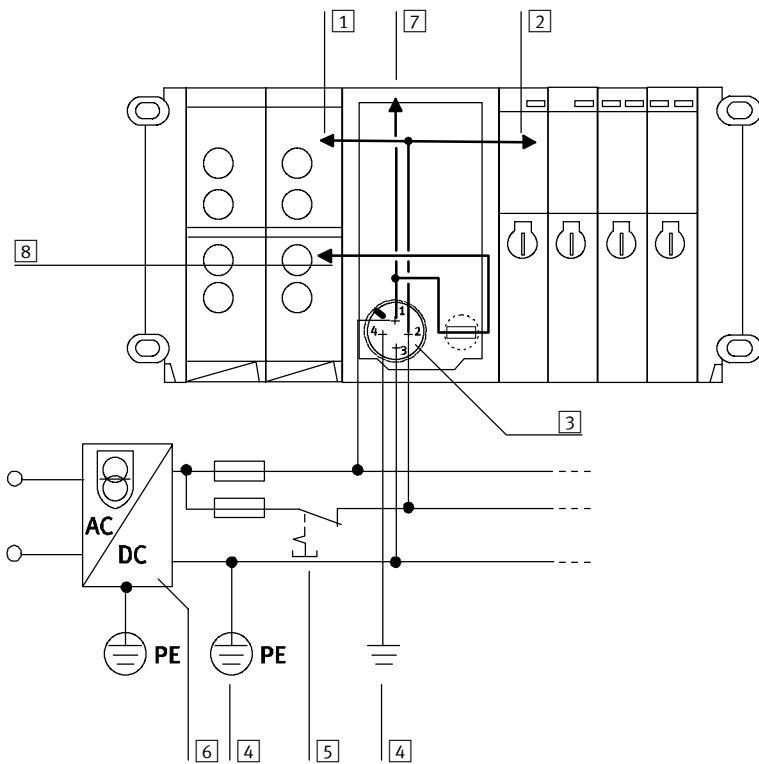

- 1 Electrical outputs (externally fused)
- 2 Valves
- 3 Voltage supply connection for node type 03
- 4 Potential equalisation
- 5 Load voltage, can be disconnected separately
- 6 Power supply unit (e.g. central voltage supply)
- 7 24 V electronics
- 8 Electrical inputs/sensors

Pin allocation

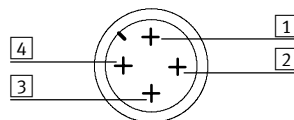

- 1 24 V DC supply for electronics and inputs
- 2 24 V DC load supply for valves
- 3 0 V
- 4 Earth terminal

Modular electrical peripherals, for type 03/04

Key features – Diagnosis

General system diagnosis		
Diagnostic information	Description	Function
Short circuit/overload at output	Output has short-circuited or become overloaded	Monitors the electrical outputs of the output modules
$V_{\text{Valves}} < 21.6 \text{ V}$	Load voltage at pin 2 (valves and outputs) of the operating voltage connection $< 21.6 \text{ V}$	Monitors the tolerance of the load voltage for valves and electrical outputs
$V_{\text{Outputs}} < 10 \text{ V}$	Load voltage at pin 2 (valves and outputs) of the operating voltage connection $< 10 \text{ V}$	Monitors the load voltage for valves and electrical outputs (no voltage, e.g. EMERGENCY-STOP)
$V_{\text{Sensor}} < 10 \text{ V}$	Operating voltage at pin 1 (electronics and inputs) of the operating voltage connection $< 10 \text{ V}$	Monitors the operating voltage for inputs (sensors). Indicates whether an internal fuse has tripped, either the fuse in the node or at least an electronic fuse in the input module ¹⁾ .

1) An electronic fuse for input modules has been available since February 1999.

Modular electrical peripherals, for type 03/04

Key features – I/O addressing



General guidelines on I/O addressing

A maximum of 12 electrical modules can be assembled. Note, however, that some modules occupy 2 or even 3 module positions, in which case the maximum number of modules that can be assembled is reduced.

All 12 module positions can generally be used as inputs or outputs, however there are various fieldbus-specific restrictions that are documented in the node description.

The number and type of inputs/ outputs, and hence input/output modules, supported by the network also depends on the fieldbus node used.

The number of solenoid coils is restricted to 26 and is included in the address space of the digital outputs.

Each sub-base for single solenoid valves occupies 2 outputs, and each sub-base for double solenoid valves occupies 4 outputs. Within the output addresses, the valve solenoids are counted in ascending order from left to right starting from the node. In the case of double solenoid valves, coil 14 comes before coil 12 in the counting mode.

The address space of the valves is always rounded up to a value divisible by 4.

The solenoid coils are followed by the general outputs in the address space. The individual outputs in the output modules are listed in the address space in ascending order, from top to bottom and the modules are listed from right to left starting from the node (see diagram).

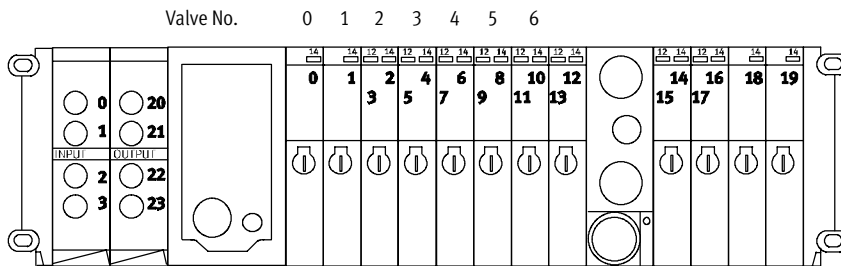

Test method for activation of the solenoid coils

The fieldbus nodes generally contain two different test sequences that activate the solenoid coils independently of any fieldbus combination or higher-order controller so that the function of the assembled valves can be verified.

The solenoid coils will be activated in parallel or serial mode depending on the test sequence selected, with each coil individually activated with a constant switching frequency in a predefined order.

Modular electrical peripherals, for type 03/04

Peripherals overview – Fieldbus systems

FESTO

Fieldbus systems, programmable terminal groups



FESTO

MOELLER 

ABB

 **Allen-Bradley**



SIEMENS

DeviceNet

ASA

Fieldbus variations:

Of the more than 20 different fieldbus systems (protocols) available in the market, some have emerged as the most important variants. Festo supports these by means of various fieldbus nodes (FBxx) on its valve terminals. Fieldbus systems require a powerful, central PLC and a master interface adapted to that particular fieldbus.

Fieldbus systems are generally used when several devices with many inputs/outputs, complex functions or high communication levels must be controlled. In this case, the advantages of simple cabling, easy diagnosis and maintenance outweigh the extra outlay for a fieldbus master interface and the necessary know-how.

Festo fieldbus:

A fieldbus developed by Festo with simple prompting, supported by the control systems in the FPC, SF and IPC series (Festo FB5).

Interbus, Interbus-FOC:

An open fieldbus standard, originally developed by Phoenix Contact and now in worldwide use. Important installation accessories such as bus plugs must be obtained from Phoenix or its partners (Festo FB6). Festo FB21 is required for Interbus-FOC, the Interbus variant "Rugged Line" with fibre optic cable.

Profibus DP:

An open fieldbus standard, originally developed by Siemens and in worldwide use (Festo FB13 for 12 MBd).

DeviceNet:

Open fieldbus standard based on the CAN technology originally developed for the automotive sector. DeviceNet was originally developed by Rockwell (Allen Bradley) and is now an open standard.

ASA (FIPIO):

Fieldbus used mainly in France (Festo FB16).

AS-interface:

The actuator-sensor interface is a less complex bus system, designed mainly for simple communication with a small number of inputs/outputs per station. Typically, there are 4 or 8 inputs/outputs per station.

An AS-interface master interface is necessary for the central PLC. A gateway (AS-interface master) in a valve terminal can provide a good connection from the AS-interface to a higher-level fieldbus protocol. This is possible with the following fieldbus protocols:

- Festo fieldbus with SF3
- Interbus with FB6, FB21
- Profibus DP with FB13, SL50
- DeviceNet with SF60

Modular electrical peripherals, for type 03/04

Peripherals overview – Control blocks



Control blocks

Integrated controllers in the Festo valve terminals permit the construction of stand-alone control units to IP65 – without control cabinets.

Using the slave operation mode, these valve terminals can be used for intelligent pre-processing and are therefore ideal modules for designing decentralised intelligence.

With the master operation mode, terminal groups can be designed with many options and functions, which can autonomously control a medium sized machine/system.

Control block variants

Integrated Festo PLC

A high performance miniature control system from Festo has been integrated into the SF3 valve terminal node. This provides stand-alone control of up to 128 inputs and 128 outputs.



With the Festo fieldbus, additional I/O and expanded functions can be installed and controlled. The control block SF3 can be operated as required as a stand-alone operation, a fieldbus slave or master (with up to 31 fieldbus slaves and up to 1048 inputs and outputs).

Integrated Allen Bradley PLC – SLC embedded

A powerful SLC5/02 mini controller from Allen Bradley, integrated in the valve terminal node SB/SF60.



This provides stand-alone control of up to 128 inputs and 128 outputs. With the DeviceNet scanner of the SF60, additional I/O and expanded functions can be installed and controlled. The control block SF60 can be operated optionally in stand-alone mode, as a DeviceNet slave or master (with up to 31 slaves).

Modular electrical peripherals, for type 03/04

Peripherals overview – Bus nodes

Equipping with bus node

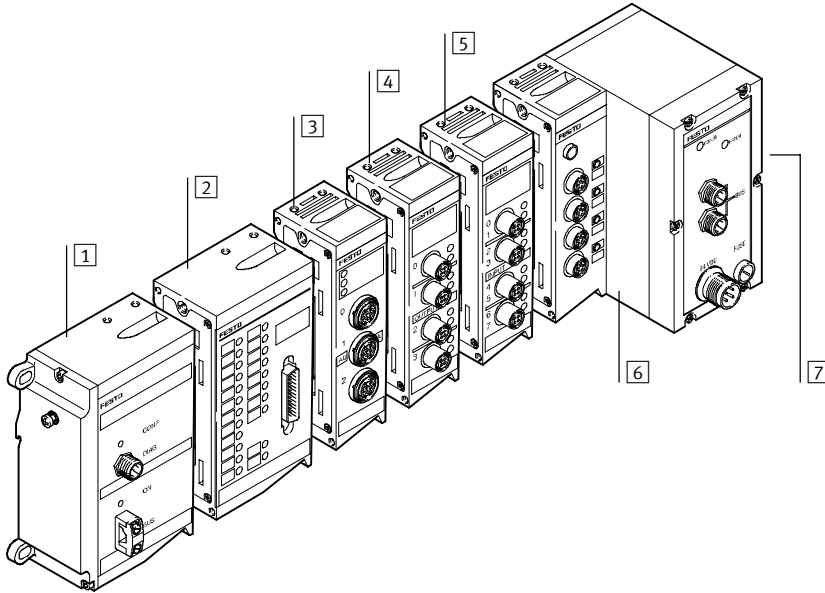

- 1 AS-interface master
- 2 Input/output module
- 3 Analogue stage
- 4 Output module
- 5 Input module
- 6 Bus node
- 7 Connection side for pneumatics

Modular electrical peripherals for type 03/04 can be equipped with various bus nodes. In addition to controlling the valves and electrical outputs, corresponding sensor feedback can be recorded at the electrical peripherals and transmitted via the fieldbus to the control cabinet.

The following applies to bus nodes:

- Max. 26 valve solenoid coils
- Number of inputs dependent on fieldbus type
- Number of electrical outputs dependent on fieldbus type and number of pneumatic valves
- Status bits for program controlled diagnosis occupy 4 input bits
 - Undervoltage of valves
 - Undervoltage of sensors
 - Short circuit at outputs
- I/O allocation, self-configuration
- Subsequent addition of input or output modules moves the addressing (I/O allocation) forwards
- I/O allocation of inputs and outputs independent from each other
- 4-fold and 8-fold input modules connect to the next Half-Byte (nibble)

- Electrical outputs connect to the next Half-Byte (nibble) on the valves.
- Counting mode: Valves from left to right, then from the next Nibble electrical outputs from right to left
- Max. 12 modules are permitted on the left (electrical) side

Modular electrical peripherals, for type 03/04

Peripherals overview – Fieldbus node

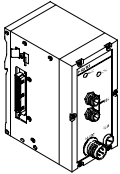
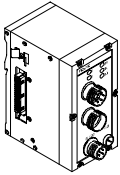
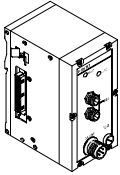
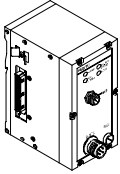
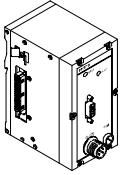
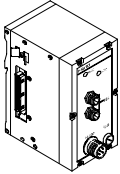
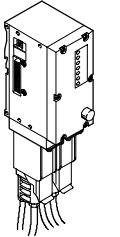
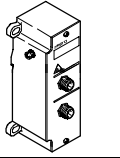

Fieldbus node							
View	Code	Type	Fieldbus protocol	Suitable for			→ Page
				I/O	AS-interface	Analogue	
	FB5	IFB5-03	Festo fieldbus, ABB (CS31), Moeller SUCONET K	■ 60/64	-	-	4 / 4.8-108
	FB6	IFB6-03	Interbus	■ 60/64	■	■	4 / 4.8-112
	FB8	IFB8-03	Allen Bradley (1771 RIO)	■ 60/64	-	-	4 / 4.8-116
	F11	IFB11-03	DeviceNet, Phillips DIOS, SELECAN	■ 60/64	-	■	4 / 4.8-120
	F13	IFB13-03	Profibus DP, 12 MBd	■ 92/74	■	■	4 / 4.8-128
	F16	IFB16-03	ASA (FIPIO)	■ 60/64	-	-	4 / 4.8-132
	F21	IFB21-03	Interbus-FOC "Rugged Line"	■ 92/96	■	■	4 / 4.8-136
	AS1	VIAS1-03-4A-Z	AS-interface slave for 4 coils - To be discontinued	■ 0/4	-	-	4 / 4.8-140
	DN1	VIDN-03-8A	DeviceNet interface for 8 coils	■ 0/8	-	-	4 / 4.8-124

Modular electrical peripherals, for type 03/04

Peripherals overview – Bus nodes

Overview – Address space for bus nodes							
	IFB5-03	IFB6-03	IFB8-03	IFB11-03	IFB13-03	IFB16-03	IFB21-03
Bus protocol	Festo fieldbus, ABB (CS31), SUCONET K	Interbus	AB 1771 RIO	DeviceNet	Profibus DP	ASA (FIPIO)	Interbus-FOC
Max. total							
Inputs	60 bit	60 bit	60 bit	60 bit	92 bit	60 bit	92 bit
Outputs	64 bit	64 bit	64 bit	64 bit	74 bit	64 bit	74 bit
Max. digital							
Inputs	60 DI	60 DI	60 DI	60 DI	92 DI	60 DI	92 DI
Outputs	64 DO	60 DO	64 DO	64 DO	74 DO	64 DO	74 DO
Max. analogue							
Inputs	–	8 AI	–	8 AI	12 AI/AO	–	8 AI
Outputs	–	8 AO	–	8 AO	–	–	8 AO

- DI = Digital inputs (1 bit)
- DO = Digital outputs (1 bit)
- AI = Analogue inputs (16 bit)
- AO = Analogue outputs (16 bit)

Modular electrical peripherals, for type 03/04

Peripherals overview – Control block



Equipping with control block

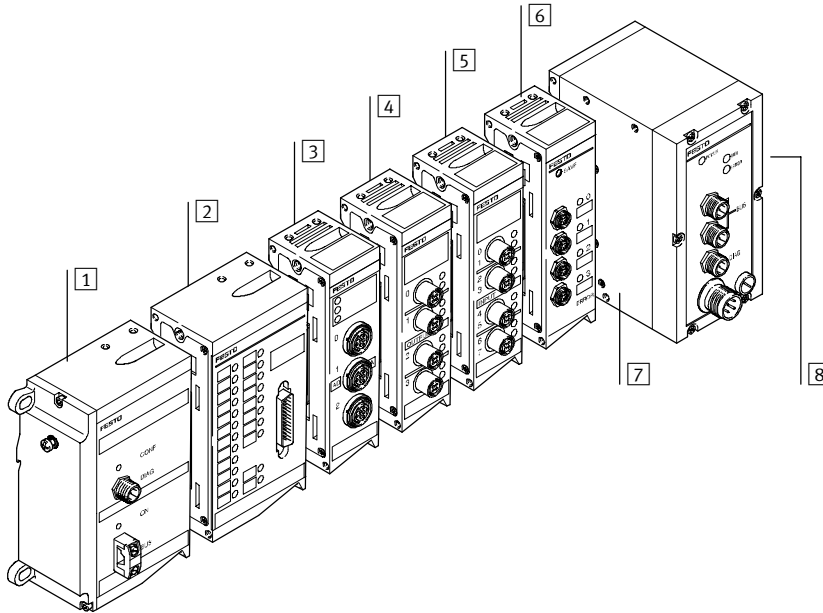

- 1 AS-interface master
- 2 Input/output module
- 3 Analogue stage
- 4 Output module
- 5 Input module
- 6 Electrical interface for CP interface
- 7 Control block
- 8 Connection side for pneumatics

Modular electrical peripherals for type 03/04 can be equipped with various control blocks. In addition to controlling the valves and outputs, corresponding sensor feedback can be recorded at the electrical peripherals and processed autonomously with the integrated PLC. Additional expansion and networking is possible via the fieldbus.

The following applies to control blocks:

- Max. 26 valve solenoid coils
- Max. 96 local inputs
- Max. 48 local outputs
- Max. 48 analogue channels (SF3), max. 18 analogue channels (SB/SF6)
- CP interface for 64 inputs and 64 outputs (decentralised 2 ... 10 m per string)
- AS-interface master for 124 inputs and 124 outputs (decentralised up to 100 m)
- I/O allocation of inputs and outputs independent from each other
- I/O allocation, self-configuration
- 4-fold and 8-fold input modules connect to the next Half-Byte (nibble)
- Electrical outputs connect to the next Half-Byte (nibble) on the valves.
Counting mode: Valves from left to right, then from the next Nibble electrical outputs from right to left
- Max. 12 modules are permitted on the left (electrical) side
- Subsequent addition of input or output modules or valves moves the addressing (I/O allocation) forwards

Modular electrical peripherals, for type 03/04

Peripherals overview – Control block

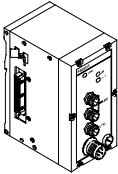
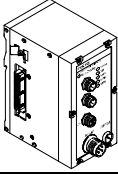
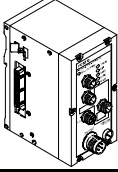

Control block								
View	Code	Type	Control block	Suitable for				→ Page
				I/O	AS-interface	PROP	CP	
	SF3	ISF3-03	SF3 with Festo fieldbus	■ 128/128	■	■	■	4 / 4.8-153
	SB6	ISB60-03	SB60 (SLC embedded)	■ 128/128	■	■	■	4 / 4.8-144
	SF6	ISF60-03-DN	SF60 (SLC embedded) with DeviceNet	■ 128/128	■	■	■	4 / 4.8-149





■ Programming the control block
ISF3-03 with FST200 in Ladder
Diagram or Statement List

■ Programming the control block
SB/SF60 with RS Logix500 under
Windows or APS under DOS.
Configuration with DeviceNet
manager or RS NetWorx

Modular electrical peripherals, for type 03/04

Peripherals overview

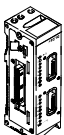
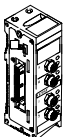

Electronics modules with multi-pin node/bus node and control block combinations								
Electronics modules	Type	Multi-pin node			Bus node			
		MP1 ¹⁾	MP2 ¹⁾	MP4 ¹⁾	FB5	FB6	FB8	F11
Input modules								
	VIGE-03-FB-8-5POL Input module for standard inputs PNP, 8-fold, 5-pin	-	-	-	■	■	■	■
	VIGE-03-FB-8,1-5POL Input module for high-speed inputs (1 ms) PNP, 8-fold, 5-pin	-	-	-	■	■	■	■
	VIGE-03-FB-8-5POL-S Input module for standard inputs PNP, 8-fold, 5-pin, with separate fuse	-	-	-	■	■	■	■
	VIGE-03-FB-8-N Input module, NPN switching 8-fold, 4-pin	-	-	-	■	■	■	■
	VIGE-03-MP-8 Input module for multi-pin connection 8-fold, 4-pin	-	■	-	-	-	-	-
	VIGE-03-FB-4-5POL Input module for standard inputs PNP, 4-fold, 5-pin	-	-	-	■	■	■	■
	VIGE-03-FB-4-N Input module, NPN switching 4-fold, 4-pin	-	-	-	■	■	■	■
	VIGE-03-MP-4 Input module for multi-pin connection 4-fold, 4-pin	-	■	-	-	-	-	-
	VIGE-03-FB-16-SUBD-S Input module with Sub-D plug PNP, 16-fold, 2x 15-pin socket	-	-	-	■	■	■	■
Output modules								
	VIGA-03-FB-4-5POL Output module for standard outputs PNP, 4-fold, 5-pin	-	-	-	■	■	■	■
	VIGA-03-FB-4-PH Output module for high currents PNP, 4-fold (4 x 2 A), 5-pin	-	-	-	■	■	■	■
	VIGA-03-FB-4-NH Output module for high currents NPN, 4-fold (4 x 2 A), 5-pin	-	-	-	■	■	■	■

1) Not for valve terminal type 04

Modular electrical peripherals, for type 03/04

Peripherals overview







Electronics modules with multi-pin node/bus node and control block combinations									
Type	Bus node					Control block			→ Page
	F13	F16	F21 ¹⁾	AS1 ¹⁾	DN1 ¹⁾	SB6	SF6	SF3 ¹⁾	
Input modules									
VIGE-03-FB-8-5POL Input module for standard inputs PNP, 8-fold, 5-pin	■	■	■	-	-	■	■	■	4 / 4.8-159
VIGE-03-FB-8,1-5POL Input module for high-speed inputs (1 ms) PNP, 8-fold, 5-pin	■	■	■	-	-	■	■	■	4 / 4.8-159
VIGE-03-FB-8-5POL-S Input module for standard inputs PNP, 8-fold, 5-pin, with separate fuse	■	■	■	-	-	■	■	■	4 / 4.8-159
VIGE-03-FB-8-N Input module, NPN switching 8-fold, 4-pin	■	■	■	-	-	■	■	■	4 / 4.8-159
VIGE-03-MP-8 Input module for multi-pin connection 8-fold, 4-pin	-	-	-	-	-	-	-	-	
VIGE-03-FB-4-5POL Input module for standard inputs PNP, 4-fold, 5-pin	■	■	■	-	-	■	■	■	4 / 4.8-159
VIGE-03-FB-4-N Input module, NPN switching 4-fold, 4-pin	■	■	■	-	-	■	■	■	4 / 4.8-159
VIGE-03-MP-4 Input module for multi-pin connection 4-fold, 4-pin	-	-	-	-	-	-	-	-	
VIGE-03-FB-16-SUBD-S Input module with Sub-D plug PNP, 16-fold, 2x 15-pin socket	■	■	■	-	-	■	■	■	4 / 4.8-163
Output modules									
VIGA-03-FB-4-5POL Output module for standard outputs PNP, 4-fold, 5-pin	■	■	■	-	-	■	■	■	4 / 4.8-166
VIGA-03-FB-4-PH Output module for high currents PNP, 4-fold (4 x 2 A), 5-pin	■	■	■	-	-	■	■	■	4 / 4.8-166
VIGA-03-FB-4-NH Output module for high currents NPN, 4-fold (4 x 2 A), 5-pin	■	■	■	-	-	■	■	■	4 / 4.8-166

1) Not for valve terminal type 04

Modular electrical peripherals, for type 03/04

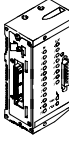
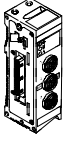
Peripherals overview

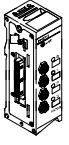

Electronics modules with multi-pin node/bus node and control block combinations								
Electronics modules	Type	Multi-pin node			Bus node			
		MP1 ¹⁾	MP2 ¹⁾	MP4 ¹⁾	FB5	FB6	FB8	F11
Additional power supply								
	VIGV-03-FB-24V-25A Additional power supply 25 A for high-current output modules, suitable for PNP/NPN	-	-	-	■	■	■	■
Input/output modules								
	VIEA-03-FB-12E-8A-SUBD Input/output module PNP, 12I/8O, Sub-D	-	-	-	■	■	■	■
	VIEA-03-FB-12E-8A-N-SUBD Input/output module NPN, 12I/8O, Sub-D	-	-	-	■	■	-	■
Analogue stage								
	VIAU-03-FB-U Analogue stage 3I/1O, 0 ... 10 V	-	-	-	-	■	-	■
	VIAU-03-FB-I Analogue stage 3I/1O, 4 ... 20 mA	-	-	-	-	■	-	■
	VIAP-03-FB Analogue stage for proportional valve 1I/1O	-	-	-	-	■	-	■
Electrical interface								
	VIGCP-03-FB Electrical interface to a CP installation system	-	-	-	-	-	■	-
	VIASI-03-M Electrical interface to an AS-interface network	-	-	-	-	■	-	-

1) Not for valve terminal type 04

Modular electrical peripherals, for type 03/04

Peripherals overview



Electronics modules with multi-pin node/bus node and control block combinations									
Type	Bus node					Control block			→ Page
	F13	F16	F21 ¹⁾	AS1 ¹⁾	DN1 ¹⁾	SB6	SF6	SF3 ¹⁾	
Additional power supply									
VIGV-03-FB-24V-25A Additional power supply 25 A, suitable for PNP/NPN	■	■	■	-	-	■	■	■	4 / 4.8-171
Input/output modules									
VIEA-03-FB-12E-8A-SUBD Input/output module PNP, 12I/8O, Sub-D	■	■	■	-	-	■	■	■	4 / 4.8-173
VIEA-03-FB-12E-8A-N-SUBD Input/output module NPN, 12I/8O, Sub-D	■	-	■	-	-	■	■	■	4 / 4.8-173
Analogue stage									
VIAU-03-FB-U Analogue stage 3I/1O, 0 ... 10 V	■	-	■	-	-	■	■	■	4 / 4.8-176
VIAU-03-FB-I Analogue stage 3I/1O, 4 ... 20 mA	■	-	■	-	-	■	■	■	4 / 4.8-176
VIAP-03-FB Analogue stage for proportional valve 1I/1O	■	-	■	-	-	■	■	■	4 / 4.8-176
Electrical interface									
VIGCP-03-FB Electrical interface to a CP installation system	-	-	-	-	-	■	■	■	4 / 4.8-180
VIASI-03-M Electrical interface to an AS-interface network	■	-	■	-	-	■	■	■	4 / 4.8-182

1) Not for valve terminal type 04

Modular electrical peripherals, for type 03/04

Technical data – Bus node IFB5-03

FESTO

FESTO

MOELLER 

ABB

This bus node handles communication between the modular electrical peripherals and a higher-order master.

For the modular electrical peripherals, this module provides the separate electrical system supply for

- the electronics modules and sensor supply, and
- the load current of the electrical outputs and valves.

The bus node supports three different company-specific fieldbus protocols, based on a floating RS485 connection.

The required protocol is selected by means of switch settings.

- Festo fieldbus
- ABB CS31
- Moeller SUCONET K



Application

Bus connection

The bus connection on the IFB5-03 is established by means of two 4-pin M12 plugs with four connections. The two plugs are connected internally, so that either a branch line installation can be performed with one cable,

or 2 cables can be routed to the bus node, connected to the two plugs and looped through.

Implementation

The IFB5-03 supports the digital input and output modules and the solenoid coils. It does not support analogue modules or the AS-interface master.

It can service a total of 64 digital outputs, of which max. 26 can include solenoid coils, and 60 digital inputs.

 Note

Please observe the general guidelines on I/O addressing when assigning the outputs.

Modular electrical peripherals, for type 03/04

Technical data – Bus node IFB5-03

General technical data		
Type		IFB5-03
Part No.		18 735
Combination with analogue modules		No
Combination with AS-interface master		No
Baud rates	Festo fieldbus	Set using HW switch <ul style="list-style-type: none"> ■ 31.25 kbps ■ 62.50 kbps ■ 187.50 kbps ■ 375 kbps
	ABB CS31	187.50 kbps
	Moeller SUCONET K	Baud rate set automatically <ul style="list-style-type: none"> ■ 187.50 kbps ■ 375 kbps
Addressing range	Festo fieldbus	1 ... 99
	ABB CS31	1 ... 60
	Moeller SUCONET K	1 ... 99
Type of communication	Festo fieldbus	Cyclic polling
	ABB CS31	I16, O16 or I/O16
	Moeller SUCONET K	Up to 32 I/O: SIS-K-06/07 Up to 64 I/O: SIS-K-10/10
Max. no. of coils		26
Max. no. of outputs incl. solenoid coils		64
Max. no. of inputs		60
LED diagnostic displays	Power	Operating status
	Bus	Error status
Device-specific diagnostics transmitted to the controller		<ul style="list-style-type: none"> ■ Short circuit/overload, outputs ■ Undervoltage of valves ■ Undervoltage of outputs ■ Undervoltage of sensor supply
Operating voltage	Nominal value	24 V DC polarity-safe
	Permissible range	18 ... 30 V
	Power failure buffering	20 ms
Current consumption		200 mA + total current consumption of inputs, internal
Certification		CE
Protection class to EN 60 529		IP65
Temperature range	Operation	-5 ... +50 °C
	Storage	-20 ... +70 °C
Materials	Housing	Die-cast aluminium
	Cover	Polyamide
Dimensions (HxWxD)		132 x 85 x 125 mm
Grid dimension		72 mm
Weight		1000 g

Modular electrical peripherals, for type 03/04

Technical data – Bus node IFB5-03



Connection and display components

The following connection and display components can be found on the bus node cover:

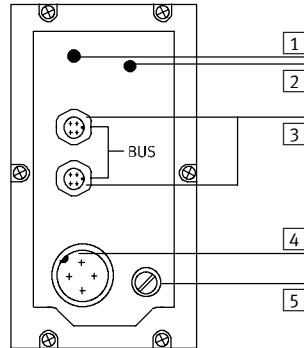



- 1 Green LED / Power
- 2 Red LED / Bus
- 3 Plugs for fieldbus cable
- 4 Operating voltage connection
- 5 Fuse for operating voltage of inputs

Pin allocation for fieldbus interface

Terminal allocation	Pin No.	Signal
	1	Plug 1
	1	S+/Bus2
	2	n.c.
	3	S-/Bus2
	4	Screen/shield
	2	Plug 2
	1	S+/Bus1
	2	n.c.
3	S-/Bus1	
4	Screen/shield	
3	Internal network	
4	Housing/node	

Modular electrical peripherals, for type 03/04

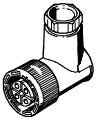
Accessories – Bus node IFB5-03

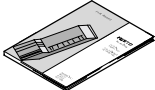
Ordering data				
Designation			Type	Part No.
Power supply				
	Plug socket, straight	for 1.5 mm ²	NTSD-GD-9	18 493
		for 2.5 mm ²	NTSD-GD-13,5	18 526
	Plug socket, angled	for 1.5 mm ²	NTSD-WD-9	18 527
		for 2.5 mm ²	NTSD-WD-11	533 119
Fieldbus connection				
	Bus connection, straight	PG7	FBSD-GD-7	18 497
		PG9	FBSD-GD-9	18 495
		PG13.5	FBSD-GD-13,5	18 496
	Bus connection, angled	PG7	FBSD-WD-7	18 524
		PG9	FBSD-WD-9	18 525
User documentation				
	User documentation – Bus node IFB5-03	German	P.BE-VIFB5-03-DE	152 755
		English	P.BE-VIFB5-03/05-EN	152 765

Modular electrical peripherals, for type 03/04

Technical data – Bus node IFB6-03

FESTO



This bus node handles communication between the modular electrical peripherals and a higher-order master.

For the modular electrical peripherals, this module provides the separate electrical system supply for

- the electronics modules and sensor supply, and
- the load current of the electrical outputs and valves.



Application

Bus connection

The bus connection is established via two 9-pin M23 connections with a typical Interbus pin allocation.

The plug and socket are labelled with Remote IN and Remote OUT in accordance with the definition for the Interbus remote bus.

Both bus cables are always routed to the bus node and looped through in accordance with the ring structure of the Interbus.

Implementation

The IFB6-03 supports the digital input and output modules and the solenoid coils. It also supports analogue modules and the AS-interface master. It can service a total of 64 digital outputs, of which max. 26 can include solenoid coils, and 60 digital inputs.

The FB6 supports max. 8 analogue input channels and 8 analogue output channels. The analogue channels are operated in multiplex mode and occupy 16 process data bits. The number of possible digital inputs and outputs is reduced by 16 bits when analogue modules are used.

Inputs and outputs of the AS-interface master are included in the address range of the digital inputs and outputs. Combined they may not exceed the limit of 60 inputs and 64 outputs.



Note

Please observe the general guidelines regarding addressing when assigning outputs.

Modular electrical peripherals, for type 03/04

Technical data – Bus node IFB6-03

FESTO

General technical data		
Type	IFB6-03	
Part No.	18 736	
Combination with analogue modules	Yes	
Combination with AS-interface master	Yes	
Baud rates	500 kbps	
ID code	1, 2 or 3 depending on expansion	
No. of process data bits	16, 32, 48 or 64 depending on expansion	
PCP channel	No	
Configuration support	<ul style="list-style-type: none"> ■ Icon file for CMD software ■ Station description file with CMD software 	
Max. no. of solenoid coils	26	
Max. no. of outputs incl. solenoid coils	64	
Max. no. of inputs	60	
LED diagnostic displays	UL	Operating voltage of internal electronics
	UI	Operating voltage of Interbus interface
	RC	Remotebus check
	BA	Bus active
	RD	Remotebus disable
Device-specific diagnostics transmitted to the controller	<ul style="list-style-type: none"> ■ Short circuit/overload, outputs ■ Undervoltage of valves ■ Undervoltage of outputs ■ Undervoltage of sensor supply ■ Error during analogue processing ■ AS-interface master error 	
Operating voltage	Nominal value	24 V DC polarity-safe
	Permissible range	18 ... 30 V
	Power failure buffering	20 ms
Current consumption	200 mA + total current consumption of inputs, internal	
Protection class to EN 60 529	IP65	
Temperature range	Operation	-5 ... +50 °C
	Storage	-20 ... +70 °C
Materials	Housing	Die-cast aluminium
	Cover	Polyamide
Dimensions (HxWxD)	132 x 85 x 125 mm	
Grid dimension	72 mm	
Weight	1000 g	

Modular electrical peripherals, for type 03/04

Technical data – Bus node IFB6-03

Connection and display components

The following connection and display components can be found on the bus node cover:

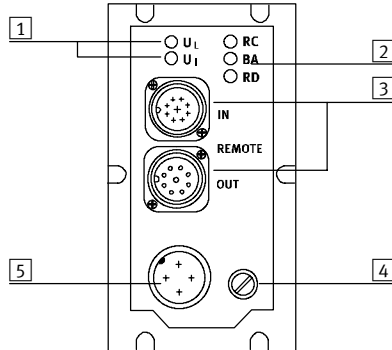

- 1 Power supply indicator
- 2 Fieldbus status indicator
- 3 INTERBUS interface
- 4 Fuse for operating voltage of inputs
- 5 Operating voltage connection

Pin allocation for the INTERBUS interface, non-floating installation remote bus

Terminal allocation	Pin No. ¹⁾	Signal	Designation
Incoming			
Plug view 	1	DO	Data out
	2	/DO	Data out inverse
	3	DI	Data in
	4	/DI	Data in inverse
	5	Ground	Reference conductor
	6	FE	Functional earthing
	7	+24 V	Installation remote bus supply
	8	+0 V	Installation remote bus supply
	Sleeve	Screen	Screening
	Outgoing		
Socket view 	1	DO	Data out
	2	/DO	Data out inverse
	3	DI	Data in
	4	/DI	Data in inverse
	5	Ground	Reference conductor
	6	FE	Functional earthing Installation remote bus
	7	+24 V	Installation remote bus supply
	8	+0 V	Installation remote bus supply
	9	RBST	Establish bridge to pin 5
	Sleeve	Screen	Screening

1) Pins not listed here must not be connected.

Modular electrical peripherals, for type 03/04

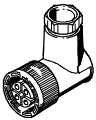
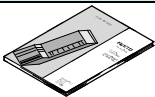

Accessories – Bus node IFB6-03

Ordering data				
Designation			Type	Part No.
Power supply				
	Plug socket, straight	for 1.5 mm ²	NTSD-GD-9	18 493
		for 2.5 mm ²	NTSD-GD-13,5	18 526
	Plug socket, angled	for 1.5 mm ²	NTSD-WD-9	18 527
		for 2.5 mm ²	NTSD-WD-11	533 119
User documentation				
	User documentation – Bus node IFB6-03	German	P.BE-VIFB6-03-DE	152 756
		English	P.BE-VIFB6-03-EN	152 766
		French	P.BE-VIFB6-03-FR	163 926
		Spanish	P.BE-VIFB6-03-ES	163 906
		Italian	P.BE-VIFB6-03-IT	165 426
		Swedish	P.BE-VIFB6-03-SV	165 456

Modular electrical peripherals, for type 03/04

Technical data – Bus node IFB8-03

FESTO



This bus node handles communication between the modular electrical peripherals and a higher-order master.

For the modular electrical peripherals, this module provides the separate electrical system supply for

- the electronics modules and sensor supply, and
- the load current of the electrical outputs and valves.

The bus node supports the 1771 Remote I/O fieldbus from Allen Bradley/Rockwell Automation.



Application

Bus connection

The FB8 bus node has 2 M12 plugs with 4 connections for connecting to the Remote interface.

The two plugs are connected internally, so that either a branch line installation can be performed with one cable, or 2 cables can be routed to the bus node, connected to the two plugs and looped through.

Implementation

The IFB8-03 supports the digital input and output modules and the solenoid coils. It does not support analogue modules or the AS-interface master.

It can service a total of 64 digital outputs, of which max. 26 can include solenoid coils, and 60 digital inputs.

The CP interface module can be connected as an alternative if the CP installation system is used, however this mode of operation does not support the direct mounting of valves and input/output modules.

 Note

Please observe the general guidelines on I/O addressing when assigning the outputs.

Modular electrical peripherals, for type 03/04

Technical data – Bus node IFB8-03

General technical data		
Type		IFB8-03
Part No.		18 738
Combination with analogue modules		No
Combination with AS-interface master		No
Baud rates		Set using HW switch <ul style="list-style-type: none"> ■ 57.6 kbps ■ 115.2 kbps ■ 230.4 kbps
Addressing range		The maximum rack number and I/O group depends on the controller connected. With PLC-3 up to rack no. 30 group 4/5.
Emulated product		Remote Rack Quarter rack or half rack
Configuration support		Automatic configuration as a quarter or half rack
Max. no. of solenoid coils		26
Max. no. of outputs incl. solenoid coils		64
Max. no. of inputs		60
LED diagnostic displays	Power	Operating status
	Bus	Error status
Device-specific diagnostics transmitted to the controller		<ul style="list-style-type: none"> ■ Short circuit/overload, outputs ■ Undervoltage of valves ■ Undervoltage of outputs ■ Undervoltage of sensor supply
Operating voltage	Nominal value	24 V DC polarity-safe
	Permissible range	18 ... 30 V
	Power failure buffering	20 ms
Current consumption		200 mA + total current consumption of inputs, internal
Protection class to EN 60 529		IP65
Temperature range	Operation	-5 ... +50 °C
	Storage	-20 ... +70 °C
Materials	Housing	Die-cast aluminium
	Cover	Polyamide
Dimensions (HxWxD)		132 x 85 x 125 mm
Grid dimension		72 mm
Weight		1000 g

Modular electrical peripherals, for type 03/04

Technical data – Bus node IFB8-03



Connection and display components

The following connection and display components can be found on the bus node cover:

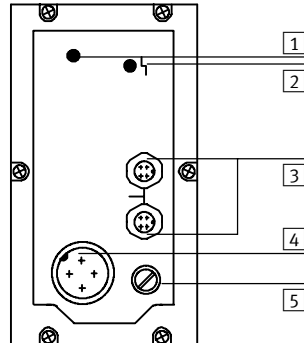

- 1 Red LED / Bus
- 2 Green LED / Power
- 3 RIO interface
- 4 Operating voltage connection
- 5 Fuse for operating voltage of inputs





Pin allocation for RIO interface

Terminal allocation	Pin No.	Signal
	1	Plug 1
	1	S+/Bus2
	2	n.c.
	3	S-/Bus2
	4	Screen/shield
	2	Plug 2
	1	S+/Bus1
	2	n.c.
3	S-/Bus21	
4	Screen/shield	
3	Internal network	
4	Housing/node	

Modular electrical peripherals, for type 03/04

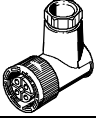
Accessories – Bus node IFB8-03

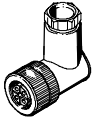

Ordering data				
Designation			Type	Part No.
Power supply				
	Plug socket, straight	for 1.5 mm ²	NTSD-GD-9	18 493
		for 2.5 mm ²	NTSD-GD-13,5	18 526
	Plug socket, angled	for 1.5 mm ²	NTSD-WD-9	18 527
		for 2.5 mm ²	NTSD-WD-11	533 119
Fieldbus connection				
	Bus connection, straight	PG7	FBSD-GD-7	18 497
		PG9	FBSD-GD-9	18 495
		PG13.5	FBSD-GD-13,5	18 496
	Bus connection, angled	PG7	FBSD-WD-7	18 524
		PG9	FBSD-WD-9	18 525
User documentation				
	User documentation – Bus node IFB8-03	German	P.BE-VIFB8-03-DE	152 758
		English	P.BE-VIFB8-03/05-EN	152 768

Modular electrical peripherals, for type 03/04

Technical data – Bus node IFB11-03



DeviceNet

This bus node handles communication between the modular electrical peripherals and a higher-order master.

For the modular electrical peripherals, this module provides the separate electrical system supply for

- the electronics modules and sensor supply, and
- the load current of the electrical outputs and valves.



Application

Bus connection

The DeviceNet connection is established via a 5-pin M12 plug with pins that corresponds to the specific mini connector.

A DeviceNet installation with a higher degree of protection is typically laid using main and branch lines that are connected via T-pieces.

Various manufacturers such as Turck, Lumberg and Rockwell offer finished cables and terminating resistors.

The terminating resistors are attached to the two outermost T-pieces. This installation technique keeps the bus closed while a bus station is being removed.

Implementation

The IFB11-03 supports the digital input and output modules, the solenoid coils and the analogue modules. It can service a total of 60 digital inputs and 64 digital outputs, of which max. 26 can include solenoid coils.

Together with the analogue modules, this bus node services max. 8 output and 8 input channels. 16 inputs and 16 outputs are always occupied if analogue modules are used, regardless of the number of analogue channels used.

 Note

Please observe the general guidelines on I/O addressing when assigning the outputs.

Modular electrical peripherals, for type 03/04

Technical data – Bus node IFB11-03

FESTO

General technical data		
Type	IFB11-03	
Part No.	18 728	
Combination with analogue modules	Yes	
Combination with AS-interface master	No	
Baud rates	Set using HW switch <ul style="list-style-type: none"> ■ 125 kbps ■ 250 kbps ■ 500 kbps 	
Addressing range	Set using 2 rotary switches 0 ... 63	
Product type	Pneumatic valve (25 dec.)	
Product code	2282/35050	
Type of communication	Polling	
Configuration support	EDS file and graphics symbol	
Max. no. of solenoid coils	26	
Max. no. of outputs and solenoid coils	64	
Max. no. of inputs	60	
Max. no. of analogue channels	8 output channels 8 input channels	
LED diagnostic displays	Power	Operating voltage of electronics
	Bus/Power	Operating voltage of bus
	MOD/NET	Operating status
	Error	Internal error
Device-specific diagnostics via DeviceNet	<ul style="list-style-type: none"> ■ Short circuit/overload, outputs ■ Undervoltage of valves ■ Undervoltage of outputs ■ Undervoltage of sensor supply 	
Operating voltage	Nominal value	24 V DC polarity-safe
	Permissible range	18 ... 30 V
	Power failure buffering	20 ms
Current consumption	200 mA + total current consumption of inputs, internal	
Protection class to EN 60 529	IP65	
Temperature range	Operation	-5 ... +50 °C
	Storage/transport	-20 ... +70 °C
Materials	Housing	Die-cast aluminium
	Cover	Polyamide
Dimensions (HxWxD)	132 x 85 x 125 mm	
Grid dimension	72 mm	
Weight	1000 g	

Modular electrical peripherals, for type 03/04

Technical data – Bus node IFB11-03



Connection and display components

The following connection and display components can be found on the bus node cover:

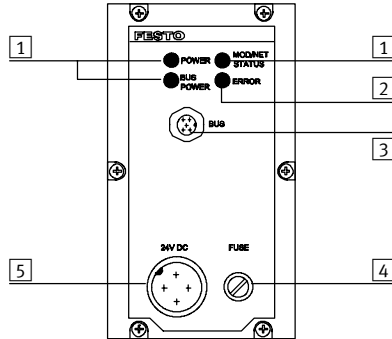

- 1 Green LEDs
- 2 Red LED
- 3 Plug for fieldbus cable
- 4 Fuse for operating voltage of inputs
- 5 Operating voltage connection

Pin allocation for fieldbus interface



Terminal allocation

Terminal allocation	Pin No.	Signal
	1	Screen
	2	+24 V bus
	3	GND Bus
	4	Data+
	5	Data-
2	Housing of the fieldbus connection module PE	
3	Internal screen connection in the valve terminal	

Modular electrical peripherals, for type 03/04

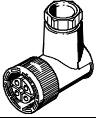

Accessories – Bus node IFB11-03

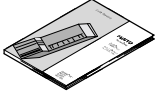
Ordering data				
Designation			Type	Part No.
Power supply				
	Plug socket, straight	for 1.5 mm ²	NTSD-GD-9	18 493
		for 2.5 mm ²	NTSD-GD-13,5	18 526
	Plug socket, angled	for 1.5 mm ²	NTSD-WD-9	18 527
		for 2.5 mm ²	NTSD-WD-11	533 119
Fieldbus connection				
	Bus connection, straight, PG9, 5-pin		FBSD-GD-9-5POL	18 324
User documentation				
	User documentation – Bus node IFB11-03	German	P.BE-VIFB11-03-DE	163 951
		English	P.BE-VIFB11-03-EN	163 956
		French	P.BE-VIFB11-03-FR	163 931
		Italian	P.BE-VIFB11-03-IT	165 431
		Swedish	P.BE-VIFB11-03-SV	165 461

Modular electrical peripherals, for type 03/04

Technical data – DeviceNet electrical interface

FESTO

DeviceNet

The DeviceNet electrical interface connects small MIDI and/or MAXI valve terminals to a DeviceNet installation. It does not support electrical modules.

There is a separate load current supply for the valves.



Application

Bus connection

The DeviceNet connection is established via a 5-pin M12 plug with pins that corresponds to the specific mini connector. A DeviceNet installation with a higher degree of protection is typically laid using main and branch lines that are connected via T-pieces.

Various manufacturers such as Turck, Lumberg and Rockwell offer finished cables and terminating resistors. The terminating resistors are attached to the two outermost T-pieces. This installation technique keeps the bus closed while a bus station is being removed.

Implementation

The DeviceNet electrical interface supports up to 8 solenoid coils.

Modular electrical peripherals, for type 03/04

Technical data – DeviceNet electrical interface

FESTO

General technical data		
Type	VIDN-03-8A	
Part No.	192 253	
Combination with analogue modules	No	
Combination with AS-interface master	No	
Baud rates	Set using HW switch <ul style="list-style-type: none"> ■ 125 kbps ■ 250 kbps ■ 500 kbps 	
Addressing range	Set using 2 rotary switches 0 ... 63	
Product type	Pneumatic valve (27 dec.)	
Product code	4587	
Type of communication	Polling and change of state/cyclic	
Configuration support	EDS file and graphics symbol	
Max. no. of solenoid coils	8	
Max. no. of outputs	None	
Max. no. of inputs	None	
LED diagnostic displays	<ul style="list-style-type: none"> ■ DeviceNet status ■ Undervoltage of valve supply 	
Device-specific diagnostics via DeviceNet	Undervoltage of valves	
Operating voltage	Nominal value	24 V DC polarity-safe
	Permissible range	18 ... 30 V
	Power failure buffering	20 ms
Interference test	Registered with ODVA	
Current consumption	10 mA + total of switched valve solenoid coils, max. 2.5 A	
Protection class to EN 60 529	IP65	
Temperature range	Operation	-5 ... +50 °C
	Storage	-20 ... +70 °C
Materials	Housing	Die-cast aluminium
	Cover	Polyamide
Dimensions (HxWxD)	132 x 45 x 55 mm	
Weight	500 g	

Modular electrical peripherals, for type 03/04

Technical data – DeviceNet electrical interface



Connection and display components

The following connection and display components can be found on the DeviceNet electrical interface:

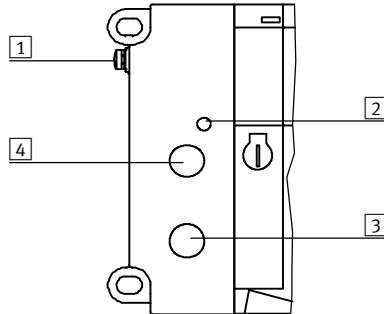

- 1 Earth terminal
- 2 Module/network status LED
- 3 Load voltage connection
- 4 Fieldbus connection

Pin allocation

Fieldbus interface

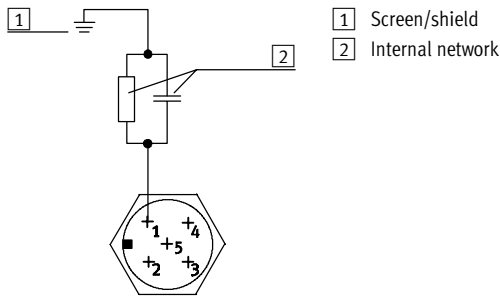

Load voltage connection

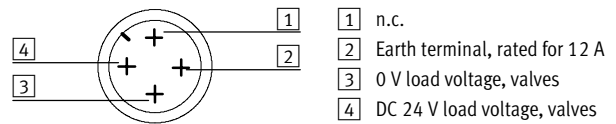

Example of circuit

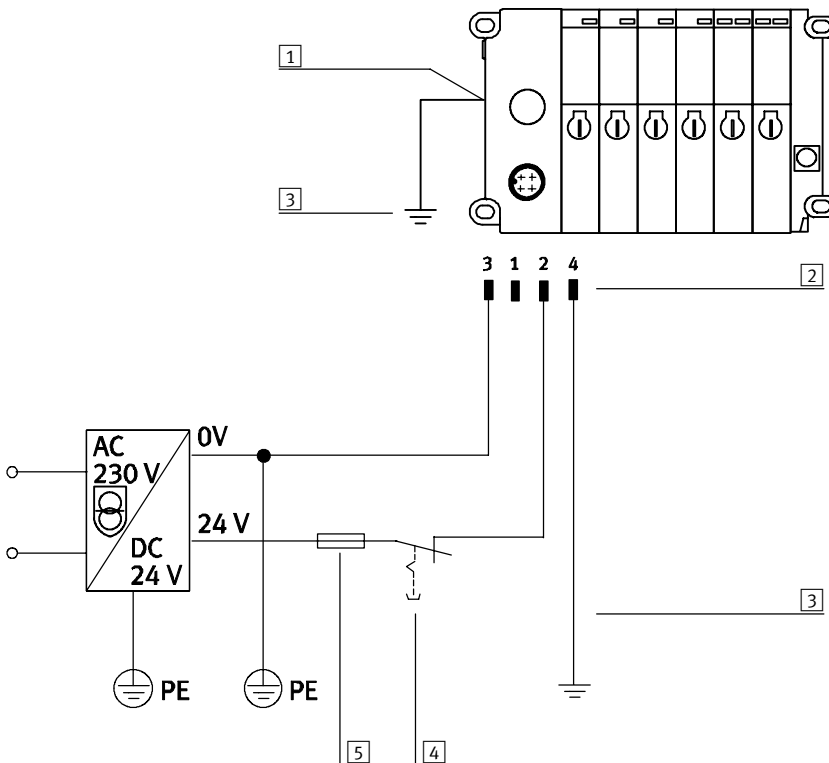



- 1 Earth terminal on housing side
- 2 Earth terminal on pin 4, rated for 12 A
- 3 Potential equalisation
- 4 Load voltage, can be disconnected separately
- 5 External fuse 6 A

Modular electrical peripherals, for type 03/04

Accessories – DeviceNet electrical interface

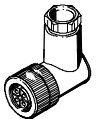

Ordering data				
Designation		Type	Part No.	
Power supply to valves				
	Plug socket, straight	PG7	FBSD-GD-7	18 497
		PG9	FBSD-GD-9	18 495
	Plug socket, angled	PG7	FBSD-WD-7	18 524
		PG9	FBSD-WD-9	18 525
Fieldbus connection				
	Bus connection, straight, PG9, 5-pin		FBSD-GD-9-5POL	18 324
User documentation				
	User documentation – DeviceNet electrical interface	German	P.BE-VIDN-03-8A-DE	193 643
		English	P.BE-VIDN-03-8A-EN	193 644
		French	P.BE-VIDN-03-8A-FR	193 645
		Spanish	P.BE-VIDN-03-8A-ES	193 646
		Italian	P.BE-VIDN-03-8A-IT	193 647
		Swedish	P.BE-VIDN-03-8A-SV	193 648

Modular electrical peripherals, for type 03/04

Technical data – Bus node IFB13-03

FESTO



Bus node for handling communication between the modular electrical peripherals and a higher-order master via Profibus DP.

For the modular electrical peripherals, this module provides the separate electrical system supply for

- the electronics modules and sensor supply, and
- the load current of the electrical outputs and valves.

The status of the voltage supplies and the bus communication is indicated via the LEDs Power, Power Valves and Bus Error.



Application

Bus connection

The bus connection is established via a 9-pin Sub-D socket with a typical Profibus allocation (to EN 50 170).

The bus connector plug (with protection class IP65 from Festo or IP20 from other manufacturers) facilitates the connection of an incoming and an outgoing bus cable.

An active bus terminal can be connected using the integrated DIL switch. The Sub-D interface is designed for the control of network components with a fibre optic cable connection.

 Note

A "Reverse Key" connection can be established via a 2x M12 adapter plug (B-coded).

Implementation

The IFB13-03 supports digital input and output modules and solenoid coils. Analogue modules and an AS-interface master can also be used.

- 74 digital outputs in total, of which max. 26 solenoid coils.
- Max. 92 digital inputs for recording sensor signals.

The bus node supports max. 12 analogue input/output channels. The AS-interface master permits the activation of 31 AS-interface slaves. Analogue modules and AS-interface slaves each occupy a discrete address space, separate from the digital inputs and outputs.

 Note

When assigning the electrical modules, please observe the configuration guidelines for valve terminals in relation to address allocation and the number of occupied module positions.

Modular electrical peripherals, for type 03/04

Technical data – Bus node IFB13-03

FESTO

General technical data		
Type	IFB13-03	
Part No.	174 335	
Combination with analogue modules	Yes	
Combination with AS-interface master	Yes	
Baud rates	Automatic detection 9.6 kBaud ... 12 MBaud	
Addressing range	Set using 2 rotary switches and a DIL switch 1 ... 125	
Product family	4: Valves	
Ident. number	0xFB13	
Type of communication	Cyclic communication	
Configuration support	GSD file and bitmaps	
Max. no. of solenoid coils	26	
Max. no. of outputs and solenoid coils	74	
Max. no. of inputs	92	
Max. no. of analogue channels	12 input/output channels	
LED diagnostic displays	Power	Operating voltage of electronics
	Power V	Operating voltage of valves and outputs
	Bus Error	Communication error
Device-specific diagnostics via Profibus DP	<ul style="list-style-type: none"> ■ Short circuit/overload, outputs (channel diagnostics) ■ Undervoltage of valves ■ Undervoltage of outputs ■ Undervoltage of sensor supply ■ Error during analogue processing ■ Error in AS-interface master and individual diagnosis of AS-interface slaves 	
Additional functions	<ul style="list-style-type: none"> ■ Status/diagnostic bits in the process image of the inputs ■ Test routine for checking the valves and outputs without bus communication ■ Indication of the valve terminal configuration via Power V and Bus Error LEDs 	
Operating voltage	Nominal value	24 V DC polarity-safe
	Permissible range	18 ... 30 V
	Power failure buffering	20 ms
Current consumption	200 mA + total current consumption of inputs, internal	
Protection class to EN 60 529	IP65	
Temperature range	Operation	-5 ... +50 °C
	Storage/transport	-20 ... +70 °C
Materials	Housing	Die-cast aluminium
	Cover	Polyamide
Dimensions (HxWxD)	132 x 85 x 125 mm	
Grid dimension	72 mm	
Weight	1000 g	

Modular electrical peripherals, for type 03/04

Technical data – Bus node IFB13-03



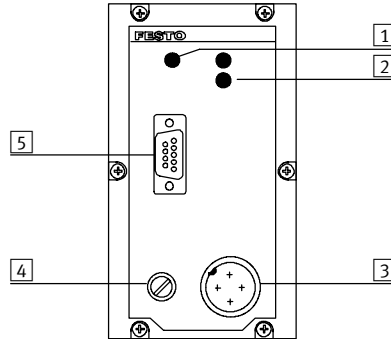

Connection and display components

The following connection and display components can be found on the bus node cover:

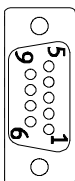

- 1 Green LED / Power
- 2 Red LED / Bus
- 3 Operating voltage connection
- 4 Fuse for operating voltage of inputs
- 5 Plug for fieldbus cable

Pin allocation for Profibus DP interface

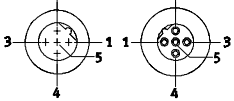

	Terminal allocation	Pin No.	Signal	Designation	
Plug, Sub-D					
	Viewed from the socket side 	1	n.c.	Not connected	
		2	n.c.	Not connected	
		3	RxD/TxD-P	Received/transmitted data P	
		4	CNTR-P ¹⁾	Repeater control signal	
		5	DGND	Data reference potential (M5V)	
		6	VP	Supply voltage (P5V)	
		7	n.c.	Not connected	
		8	RxD/TxD-N	Received/transmitted data N	
		9	n.c.	Not connected	
		Housing	Screen	Connection to housing	
Bus connection M12 adapter plug (B-coded)					
	Plug and socket 	Plug	1	n.c.	Not connected
			2	RxD/TxD-N	Received/transmitted data N
			3	n.c.	Not connected
			4	RxD/TxD-P	Received/transmitted data P
			5 and M12	Screen	Connection to FE
		Socket	1	VP	Supply voltage (P5V)
			2	RxD/TxD-N	Received/transmitted data N
			3	DGND	Data reference potential (M5V)
			4	RxD/TxD-P	Received/transmitted data P
			5 and M12	Screen	Connection to FE

1) The repeater control signal CNTR-P is realised as a TTL signal.

Modular electrical peripherals, for type 03/04

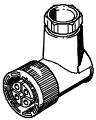
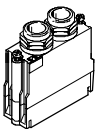

Accessories – Bus node IFB13-03

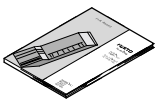
Ordering data				
Designation			Type	Part No.
Power supply				
	Plug socket, straight	for 1.5 mm ²	NTSD-GD-9	18 493
		for 2.5 mm ²	NTSD-GD-13,5	18 526
	Plug socket, angled	for 1.5 mm ²	NTSD-WD-9	18 527
		for 2.5 mm ²	NTSD-WD-11	533 119
Fieldbus connection				
	Plug, Sub-D		FBS-SUB-9-GS-9	18 529
			FBS-SUB-9-GS-DP-B	532 216
	Bus connection, 2x M12 adapter plug (B-coded)		FBA-2-M12-5POL-RK	533 118
User documentation				
	User documentation – Bus node IFB13-03	German	P.BE-VIFB13-03-DE	163 953
		English	P.BE-VIFB13-03-EN	163 958
		French	P.BE-VIFB13-03-FR	163 933
		Spanish	P.BE-VIFB13-03-ES	163 913
		Italian	P.BE-VIFB13-03-IT	165 433
		Swedish	P.BE-VIFB13-03-SV	165 463

Modular electrical peripherals, for type 03/04

Technical data – Bus node IFB16-03

FESTO

ASA

This bus node handles communication between the modular electrical peripherals and a higher-order master.

For the modular electrical peripherals, this module provides the separate electrical system supply for

- the electronics modules and sensor supply, and
- the load current of the electrical outputs and valves.
- The ASA fieldbus standard (FIPIO) works with a constant transfer rate of 1Mbit/s and is primarily supported on the master side by the Telemecanique and April controllers.
- LED displays on the bus node show the current status of communication on the bus and indicate the presence of various device errors within the valve terminal.



Application

Bus connection

The bus connection on the IFB16-03 is established via two 4-pin M12 plugs that are bridged within the bus node. This means that the bus can be interconnected in a serial arrangement with an incoming and an outgoing bus cable or connected to the bus via a branch line.

The bus address is set by means of 2 rotary switches on the bus node. The error characteristics of the outputs and the solenoid coil actuator can also be set on the node.

Implementation

The IFB16-03 supports the digital input and output modules and the solenoid coils. It can service a total of 60 digital inputs and 64 digital outputs, of which max. 26 can include solenoid coils.

The CP interface module can be connected as an alternative if the CP installation system is used, however this mode of operation does not support the direct mounting of valves.



Note

Please observe the general guidelines on I/O addressing when assigning the outputs.

Modular electrical peripherals, for type 03/04

Technical data – Bus node IFB16-03

FESTO

General technical data		
Type	IFB16-03	
Part No.	18 935	
Combination with analogue modules	No	
Combination with AS-interface master	No	
Baud rates	1 Mbaud	
Addressing range	1 ... 62	
Product profile	STD-P	
Device reference	FSD_C8	
Configuration support	Standard device profile within the configuration software	
Max. no. of solenoid coils	26	
Max. no. of outputs and solenoid coils	64	
Max. no. of inputs	60	
LED diagnostic displays	Power	Operating voltage
	NET	Status of communication
	I/O ERR	Common errors in valve terminal
	ERR	Device-specific errors
Device-specific diagnostics via FIPIO	<ul style="list-style-type: none"> ■ Short circuit/overload, outputs ■ Undervoltage of valves ■ Undervoltage of outputs ■ Undervoltage of sensor supply 	
Operating voltage	Nominal value	24 V DC polarity-safe
	Permissible range	18 ... 30 V
	Power failure buffering	20 ms
Current consumption	200 mA + total current consumption of inputs, internal	
Protection class to EN 60 529	IP65	
Temperature range	Operation	-5 ... +50 °C
	Storage	-20 ... +60 °C
Materials	Housing	Die-cast aluminium
	Cover	Polyamide
Dimensions (HxWxD)	132 x 85 x 125 mm	
Grid dimension	72 mm	
Weight	1000 g	

Modular electrical peripherals, for type 03/04

Technical data – Bus node IFB16-03



Connection and display components

The following connection and display components can be found on the bus node cover:

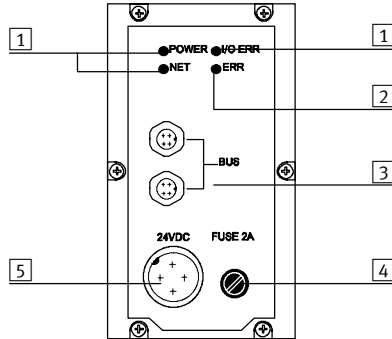

- 1 Green LED / Power
- 2 Red LED / Bus
- 3 Plugs for fieldbus cable
- 4 Fuse for operating voltage of inputs
- 5 Operating voltage connection

Pin allocation for fieldbus interface



Terminal allocation

Terminal allocation	Pin No.	Signal
	1 Plug 1	1 S+
		2 n.c.
		3 S-
		4 Screen/shield
	2 Plug 2	1 S+
		2 n.c.
		3 S-
		4 Screen/shield
3 Internal RC network		
4 Housing/node		

Modular electrical peripherals, for type 03/04

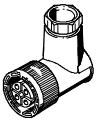

Accessories – Bus node IFB16-03

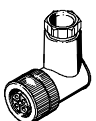
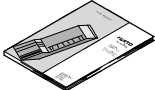
Ordering data				
Designation			Type	Part No.
Power supply				
	Plug socket, straight	for 1.5 mm ²	NTSD-GD-9	18 493
		for 2.5 mm ²	NTSD-GD-13,5	18 526
	Plug socket, angled	for 1.5 mm ²	NTSD-WD-9	18 527
		for 2.5 mm ²	NTSD-WD-11	533 119
Fieldbus connection				
	Bus connection, straight	PG7	FBSD-GD-7	18 497
		PG9	FBSD-GD-9	18 495
		PG13.5	FBSD-GD-13,5	18 496
	Bus connection, angled	PG7	FBSD-WD-7	18 524
		PG9	FBSD-WD-9	18 525
User documentation				
	User documentation – Bus node IFB16-03	German	P.BE-VIFB16-03/05-DE	164 221
		English	P.BE-VIFB16-03/05-EN	164 222
		Spanish	P.BE-VIFB16-03/05-ES	164 223
		French	P.BE-VIFB16-03/05-FR	164 224
		Italian	P.BE-VIFB16-03/05-IT	165 436
		Swedish	P.BE-VIFB16-03/05-SV	165 466

Modular electrical peripherals, for type 03

Technical data – Bus node IFB21-03

FESTO



This bus node handles communication between the modular electrical peripherals type 03 and a higher-order master.

For the modular electrical peripherals, this module provides the separate electrical system supply for

- the electronics modules and sensor supply, and
- the load current of the electrical outputs and valves.
- Interbus with Rugged Line fibre optic connection



Application

Bus connection

The bus connection is established via two Rugged Line fibre optic connections (power supply 5-pin, data fibre optics, typical Interbus allocation). The IFB21-03 corresponds to an Interbus remote bus station.

It supports the transfer of data via fibre optic cables with optical regulation of the individual transmission lengths and the looping through of the power supply from valve terminal to valve terminal. The power supply is connected via Quickon.

Implementation

The IFB21-03 supports the digital input and output modules and the solenoid coils. It also supports analogue modules and the AS-interface master. It can service a total of 96 digital outputs, of which max. 26 can include solenoid coils, and 92 digital inputs. The IFB21-03 supports max. 8 analogue input channels and 8 analogue output channels. The analogue channels are operated in multiplex mode and occupy 16 process data bits.

AS-interface inputs and outputs are included in the address range of the digital inputs and outputs. They logically occupy the process data bits after the digital (local) inputs and outputs. The number of AS-interface inputs and outputs depends on the number of assembled I/O modules and valves.

Relationship:
960 – local outputs = remainder for AS-interface outputs or
921 – local inputs = remainder for AS-interface inputs.



Note

Please observe the guidelines on configuring valves and outputs when assigning the outputs. The number of possible digital inputs and outputs is reduced by 16 bits when analogue modules are used.

Modular electrical peripherals, for type 03

Technical data – Bus node IFB21-03

General technical data		
Type	IFB21-03	
Part No.	188 844 ¹⁾	
Combination with analogue modules	Yes	
Combination with AS-interface master	Yes	
Baud rates	<ul style="list-style-type: none"> ■ 500 kbps ■ 2000 kbps 	
ID code	1, 2 or 3 depending on expansion	
No. of process data bits	16, 32, 48, 64, 80 or 96 depending on expansion	
PCP channel	No	
Configuration support	<ul style="list-style-type: none"> ■ Icon file for CMD software ■ Station description file with CMD software 	
Max. no. of solenoid coils	26	
Max. no. of outputs incl. solenoid coils	96	
Max. no. of inputs	92	
LED diagnostic displays	IB-DIAG	Interbus diagnostics
	RC	Remotebus check
	RD	Remotebus disable
	FO1	Diagnostics, incoming fibre optic cable length
	FO2	Diagnostics, outgoing fibre optic cable length
	US1	Diagnostics, logic voltage
	US2	Diagnostics, load voltage
Device-specific diagnostics transmitted to the controller	<ul style="list-style-type: none"> ■ Short circuit/overload, outputs ■ Undervoltage of valves ■ Undervoltage of outputs ■ Undervoltage of sensor supply ■ Error during analogue processing ■ AS-interface master error 	
Diagnostics via SRC	<ul style="list-style-type: none"> ■ Operating voltage US1 under 17 V ■ Load voltage of valves/outputs under 21.6 V ■ Load voltage of valves/outputs under 10 V ■ Undervoltage of sensor supply ■ Short circuit/overload of input module²⁾, 1 ... 12 (module-specific) ■ Short circuit/overload of output module³⁾, 1 ... 12 (module-specific) 	
Operating voltage	Nominal value	24 V DC polarity-safe
	Permissible range	18 ... 30 V
	Power failure buffering	20 ms
Current consumption	150 mA + total current consumption of inputs, internal	
Protection class to EN 60 529	IP65	
Temperature range	Operation	0 ... +50 °C
	Storage	-20 ... +70 °C
Materials	Housing	Die-cast aluminium
	Cover	Polyamide
Dimensions (HxWxD)	206 x 82 x 109 mm	
Grid dimension	72 mm	
Weight	1335 g	

1) Only for type 03
 2) Only VIGE-03-FB-8-5POL-S
 3) Only VIGA-03-FB-4-5POL in NPN

Modular electrical peripherals, for type 03

Technical data – Bus node IFB21-03



Connection and display components

The following connection and display components can be found on the bus node cover:

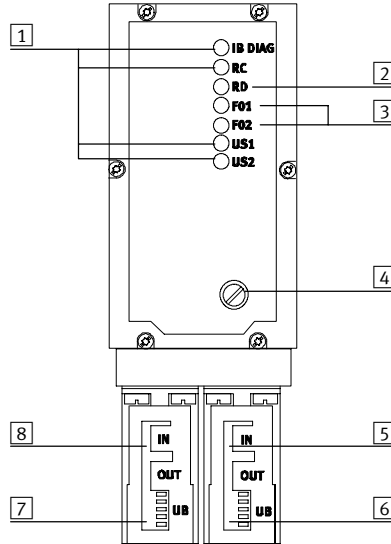

- 1 Green LED
- 2 Red LED
- 3 Yellow LED
- 4 Fuse for operating voltage of inputs
- 5 INTERBUS FOC interface, outgoing
- 6 Voltage supply connection, outgoing
- 7 Voltage supply connection, incoming
- 8 INTERBUS FOC interface, incoming

Designation	Type	
Version	Fibre optic cable (polymer fibres 980/1000 µm)	
Type of transmission	Serial asynchronous, full-duplex	
Protocol	INTERBUS	
Baud rate	500 kbps ... 2 mbps	
Cable type	Power supply	IBS PW R/5 HD/F
	Fibre optic cable	PMS-LWL-RUGGED-FLEX-980/1000 ¹⁾
	Wavelength	Typical 650 µm
Line length	Between 2 remote bus stations	1 ... 50 m
	System reserve	3 db
Plug connector	Rugged Line plug ¹⁾	

1) Can be obtained from Phoenix Contact GmbH

Modular electrical peripherals, for type 03

Technical data – Bus node IFB21-03

Example of circuit

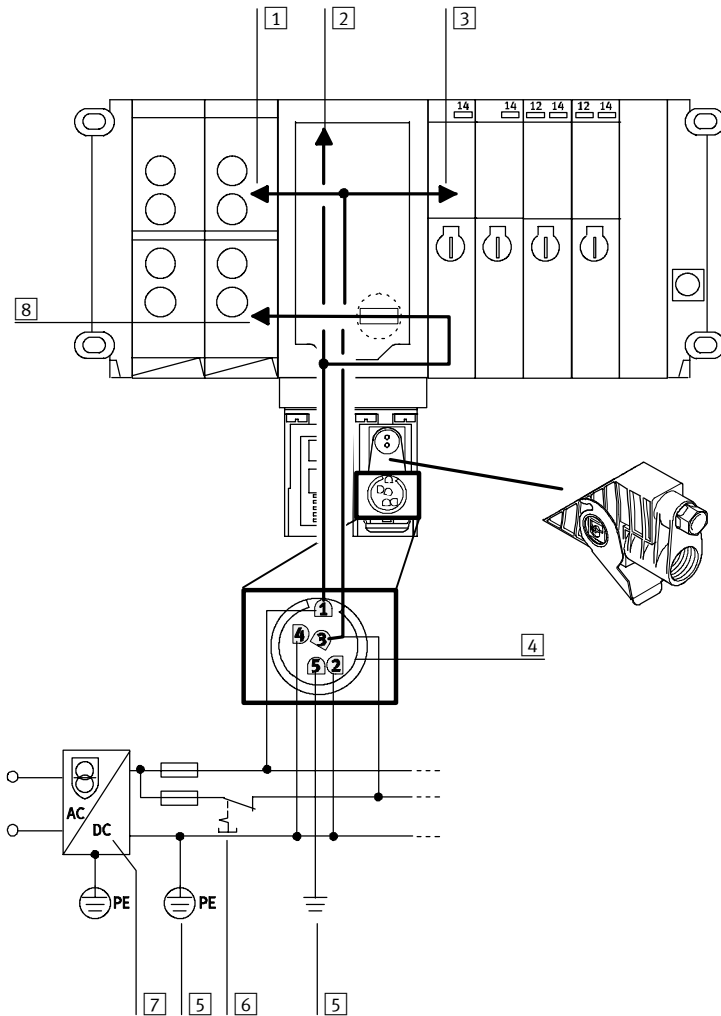

- 1 Electrical outputs (externally fused)
- 2 24 V electronics
- 3 Valves
- 4 Voltage supply connection for bus node
- 5 Potential equalisation
- 6 Load voltage, can be disconnected separately
- 7 Power supply unit (e.g. central voltage supply)
- 8 Electrical inputs/sensors

Ordering data				
Designation		Type	Part No.	
User documentation				
	User documentation – Bus node IFB21-03	German	P.BE-VIFB21-03-DE	191 084
		English	P.BE-VIFB21-03-EN	191 085

Do not use for new designs!
- 1 - Type to be discontinued

Modular electrical peripherals, for type 03/04

Technical data - AS-interface bus node VIASI-03-4A-Z

FESTO



This AS-interface bus node establishes the slave connection between MIDI and MAXI valves and the AS-interface. Up to 4 solenoid coils can then be actuated. The interface can accommodate either MIDI valves or MAXI valves, or a mixture of both. The AS-interface bus node is supplied with power from the AS-interface cable (yellow cable), and power is supplied to the solenoid coil actuator by an additional power supply (black cable). This means that load voltage for the valves can be disconnected independently of supply power for bus communications.



Application

Bus connection

The AS-interface bus node is connected directly to the interface via a flat cable socket. The electrical contact is established in the cable socket using insulation displacement technology.

General supply power, as well as communications supply power, is fed to the interface by means of the bus cable.

Electrical power for the valves is supplied by a separate, additional power supply.

Implementation

Max. 4 solenoid coils of the type MIDI or MAXI valve can be mounted. Electrical I/O modules are not supported.

- 1 - Note

Please observe the general guidelines regarding addressing when assigning outputs.

Do not use for new designs!
 - Type to be discontinued

Modular electrical peripherals, for type 03/04

Technical data - AS-interface bus node VIASI-03-4A-Z

FESTO

General technical data		
Type		VIASI-03-4A-Z
Part No.		18 783
Combination with electrical I/O modules		No
Addressing range		1 ... 31
ID code		FH
O code		8H
Type of communication		AS-interface slave
Max. no. of solenoid coils		4
LED diagnostic displays		Bus LED
Operating voltage	Bus (AS-i)	DC 26.5 ... 31.6 V
	Node	24 V DC polarity-safe
	Permissible range	DC 21.6 ... 26.4 V
Current consumption	Bus (AS-i)	Max. 17 mA
	24 V DC	Max. 360 mA; dependent on valve type
Protection class to EN 60 529		IP65
Temperature range	Operation	-5 ... +50 °C
	Storage	-20 ... +60 °C
Materials	Housing	Die-cast aluminium
	Cover	Galvanised steel
Dimensions (HxWxD)		132 x 45 x 55 mm
Weight		500 g

Do not use for new designs!
 - 1 - Type to be discontinued

Modular electrical peripherals, for type 03/04

Technical data - AS-interface bus node VIASI-03-4A-Z

FESTO

Pin allocation

AS-i interface

24 V DC interface

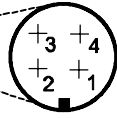
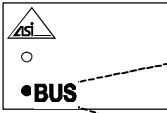

- 1 ASI+ (=brown)
- 2 n.c.
- 3 ASI- (=light brown)
- 4 n.c.

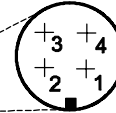
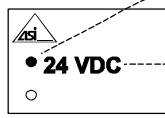

- 1 +24 V
- 2 n.c.
- 3 0 V
- 4 n.c.

Example of connection for valve terminal type 03 without/with EMERGENCY-STOP

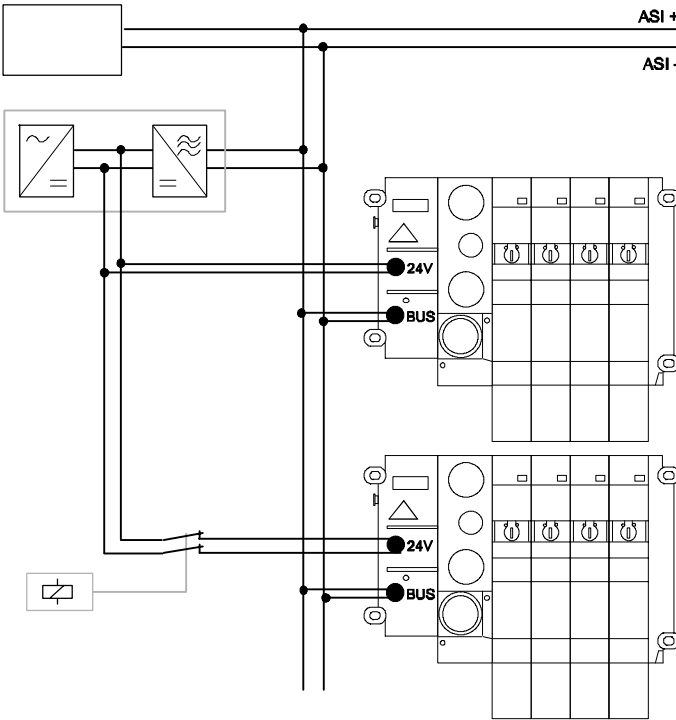

Connection of a common 24 V power supply and the protective earth (type 03 used in the example)







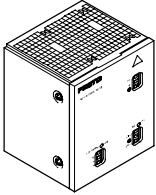

Do not use for new designs!

- 2 - Type to be discontinued

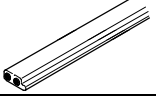
Modular electrical peripherals, for type 03/04

Accessories - AS-interface bus node VIASI-03-4A-Z

FESTO

Ordering data				
Designation	Type	Part No.		
AS-i interface				
	Combi power pack	ASI-CNT-115/230AC-B	191 082	
	Cable distributor, cable parallel rotatable	ASI-KVT-FK	18 786	
	Cable distributor, cable symmetrical	ASI-KVT-FK-S	18 797	
	Flat cable (standard cable, yellow)	KASI-1,5-Y-100	18 940	
	Flat cable (additional power supply, black)	KASI-1,5-Z-100	18 941	
	Cable socket for bus and voltage supply connection, M12, flat	ASI-SD-FK-M12	18 788	
	Cable socket for bus and voltage supply connection, M12, PG13.5	ASI-SD-PG-M12	18 789	
	Cable cap	ASI-KK-FK	18 787	
Power supply/fieldbus connection				
	Plug socket, straight, for round cable	PG7	FBSD-GD-7	18 497
		PG9	FBSD-GD-9	18 495
	Plug socket, angled, for round cable	PG7	FBSD-WD-7	18 524
		PG9	FBSD-WD-9	18 525

Modular electrical peripherals, for type 03/04

Technical data – Control block ISB60-03

FESTO



The control block ISB60-03 is an Allen Bradley SLC500 controller, integrated in a sturdy aluminium housing to protection class IP65.



Application

All plugs and electrical connections are designed for direct mounting on the machine (provided that the requirements of IP65 are adhered to). The SLC5/02 processor technology licensed by Rockwell Automation provides computing power which is tailored to the requirements of a fully expanded valve terminal. The controller is programmed using Allen Bradley's standard RSLogix500 programming software. The online connection to the PC is established using the pre-assembled programming cable.

The control block ISB60-03 is a highly compact solution; a stand-alone controller for directly mounted valve terminals of the type 03/04 or for CP valves and CP I/O modules indirectly connected via the CP installation system.

The combination of tried and tested technology in the form of pneumatic valves from Festo and controller technology from Allen Bradley produces the most compact function unit for controlling pneumatically driven movements. The elimination of internal wiring to the controller reduces the number of connection points required, thereby shortening the installation time and eliminating sources of potential errors.

The performance of the controller technology was selected and specially customised to meet the requirements of a valve terminal. Extensive diagnostic information stored in the controller's M1 file provides information on the status of all components mounted on the valve terminal as well as the sensors and actuators connected to it.

Modular electrical peripherals, for type 03/04

Technical data – Control block ISB60-03

General technical data		
Type		ISB60-03
Part No.		183 300
Combination with electrical I/O modules		All electrical peripherals are supported
Processor type		SLC5/02
Processor speed		4.8 ms/K
Memory capacity	Data words	16 K
	Program memory	4 K
No. of programs	Main program	1
	Max. subprograms	156
Max. no. of solenoid coils, direct mounted		26
Max. no. of freely available outputs, direct mounted		48
Max. no. of inputs, direct mounted		96
Max. no. of analogue output channels		9
Max. no. of analogue input channels		9
Decentralised outputs via CP interface		4 strings, each with 16 outputs
Decentralised inputs via CP interface		4 strings, each with 16 inputs
Decentralised outputs via AS-interface		124
Decentralised inputs via AS-interface		124
LED diagnostic displays		Identical to those for SLC5/02 processor
Device-specific diagnostics		<ul style="list-style-type: none"> ■ Short circuit, electrical output ■ Undervoltage of valves ■ Undervoltage of electrical outputs ■ Undervoltage of sensor supply ■ Enhanced CP string diagnostics ■ Enhanced analogue channel diagnostics ■ Enhanced AS-interface diagnostics ■ Monitoring of the valve terminal configuration
Operating voltage	Nominal value	24 V DC polarity-safe
	Permissible range	18 ... 30 V
	Power failure buffering	20 ms
Current consumption		200 mA + total current consumption of inputs, internal
Protection class to EN 60 529		IP65
Temperature range	Operation	-5 ... +50 °C
	Storage	-20 ... +70 °C
Materials	Housing	Die-cast aluminium
	Cover	Polyamide
Dimensions (HxWxD)		132 x 82 x 148 mm
Grid dimension		72 mm
Weight		1200 g

Integrated DH-485 coupling

The network DH-485 is an integral element of the control block. This network allows different control blocks and the Allen Bradley controllers to exchange data in a peer-to-peer arrangement. Pre-assembled

connecting cables for the connection of all current HMI control units such as Panel View, DTAM Micro and DTAM Plus to the control block are available as accessories.

The network DH-485 together with the necessary DH-485 link coupler are generally integrated in the control block. The consistent integration of all necessary components in the housing

of the control block means that the network DH-485 can be expanded to include a valve terminal in the field whilst maintaining protection class IP65.

Modular electrical peripherals, for type 03/04

Technical data – Control block ISB60-03

Connection and display components

The following connection and display components can be found on the control block cover:

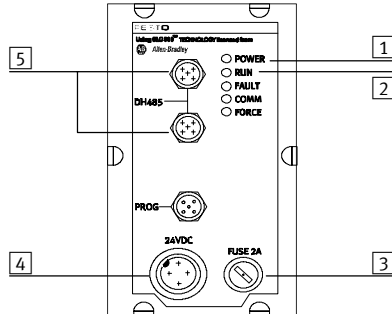

- 1 Green LED / POWER
- 2 Red LED / RUN
- 3 Fuse for operating voltage of inputs
- 4 Operating voltage connection
- 5 Plug for DH-485

DIP switch settings

The control block is equipped with DIP switches for activating the DH-485 bus terminal.

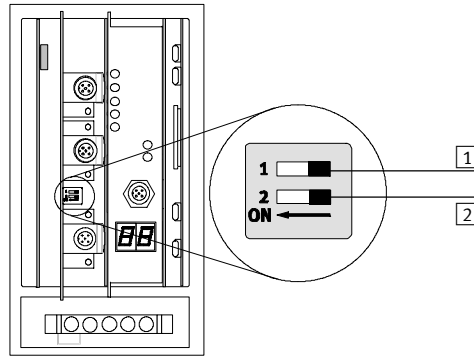

- 1 On: Bus terminal activated
Off (condition upon delivery): Bus terminal not activated
- 2 On: Earthing of the DH-485 screen activated
Off (condition upon delivery): DH-485 screen not activated

Positioning of the DIP switches for the bus terminal and earth on the DH-485

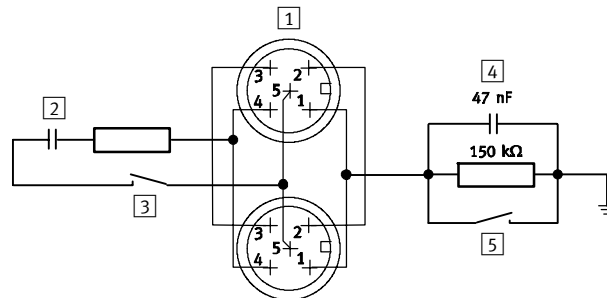

- 1 Connection of the DH-485 to the control block
- 2 DH-485 bus terminal
- 3 DIP switch 1
- 4 DH-485 earth
- 5 DIP switch 2

Modular electrical peripherals, for type 03/04

Technical data – Control block ISB60-03

Connection examples

Cable for DH-485 is looped through

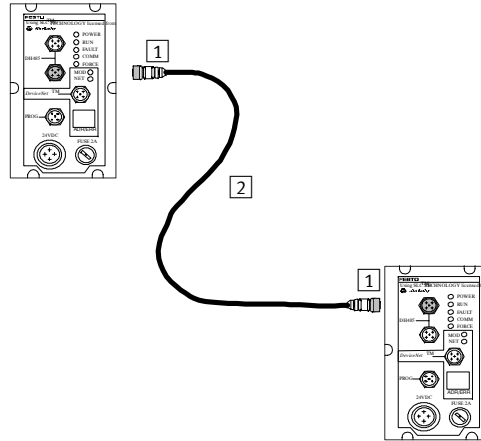

- 1 Connection socket, straight, 5-pin
- 2 Belden cable #9842

Cable for T-adapter

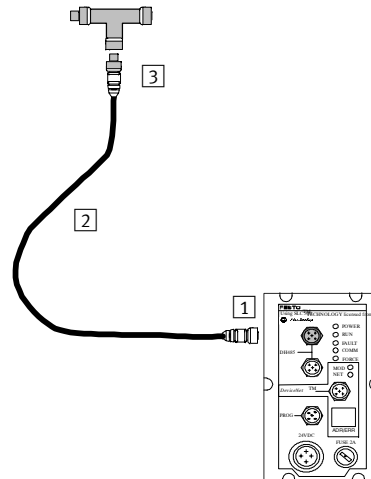





- 1 Connection socket, straight, 5-pin
- 2 Belden cable #9842
- 3 Straight plug, 5-pin for T-adapter

Modular electrical peripherals, for type 03/04

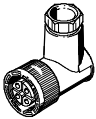
FESTO

Accessories – Control block ISB60-03

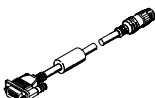
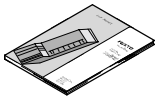
Ordering data				
Designation			Type	Part No.
Power supply				
	Plug socket, straight	for 1.5 mm ²	NTSD-GD-9	18 493
		for 2.5 mm ²	NTSD-GD-13,5	18 526
	Plug socket, angled	for 1.5 mm ²	NTSD-WD-9	18 527
		for 2.5 mm ²	NTSD-WD-11	533 119
Fieldbus connection				
	Plug socket, straight, 5-pin		FBSD-GD-9-5POL	18 324
	Plug, straight, 5-pin for T-adapter		FBS-M12-5GS-PG9	175 380
	T-adapter for DH-485		FB-TA-M12-5POL	171 175
Diagnostic/data connection				
	Programming cable	3 m	KDI-SB60-3,0-M12	171 173
		6 m	KDI-SB60-6,0-M12	175 686
		10 m	KDI-SB60-10,0-M12	171 174
	Cable for DTAM Micro	3 m	KDTAM-SB60-3-M12	188 979
		6 m	KDTAM-SB60-6-M12	188 980
		10 m	KDTAM-SB60-10-M12	188 981
User documentation				
	User documentation – Control block ISB60-03	German	P.BE-VISB60-03-DE	184 572
		English	P.BE-VISB60-03-EN	184 573
		Spanish	P.BE-VISB60-03-ES	184 575

Modular electrical peripherals, for type 03/04

Technical data – Control block ISF60-03-DN

FESTO

DeviceNet



The ISF60-03-DN control block is an Allen Bradley SLC500 controller with an additional DeviceNet link enclosed in a sturdy aluminium housing with IP65 protection.



Application

In addition to the SLC5/02 processor, the ISF60-03-DN control block is also equipped with an integrated type 1747-SDN DeviceNet scanner. The SLC5/02 processor technology and 1747-SDN scanner technology licensed by Rockwell Automation provides the computing and networking power, tailored to the requirements of a fully expanded valve terminal with networked installation synchronisation.

The controller is programmed and configured using standard Allen Bradley software. The program is created using RSLogix500 and DeviceNet, and is configured using RSNetworx for DeviceNet. The online connection to the PC is established using the pre-assembled programming cable.

The control block ISF60-03-DN is a highly compact solution; a stand-alone controller for directly mounted valve terminals of the type 03/04 or for CP valves and CP I/O modules indirectly connected via the CP installation system. The DeviceNet scanner can be used to network and synchronise stand-alone function units.

Modular electrical peripherals, for type 03/04

Technical data – Control block ISF60-03-DN



Note

The mode of operation and functional scope of the control block ISF60-03-DN is identical to that of the control block ISB60-03.

This means that all technical data for the control block ISB60-03 also applies to the control block ISF60-03-DN. You will find this data in the description for the control block ISB60-03 (→ 4 / 4.8-144).

The following table therefore only lists added characteristics of the DeviceNet scanner.

General technical data		
Type	ISF60-03-DN	
Part No.	183 301	
Combination with electrical I/O modules	All electrical peripherals are supported	
Addressing range	0 ... 63	
Product type	Communication converter (12 dec.)	
Product code	SF60 scanner 1747-SDN (19 dec.)	
Type of communication	<ul style="list-style-type: none"> ■ Polled I/O ■ Change of state/cyclic ■ Strobed I/O ■ Explicit messaging 	
Data storage area for DeviceNet	Input data	32 bytes, plus M1 file
	Output data	32 bytes, plus M0 file
Mode of operation on DeviceNet	<ul style="list-style-type: none"> ■ DeviceNet master ■ Intelligent DeviceNet slave with exchange of data with the master ■ Intelligent slave with assigned slave station on DeviceNet 	
Diagnostic indicators	LEDs and 7 segment display identical to those of 1747-SDN	
Operating voltage	Nominal value	24 V DC polarity-safe
	Permissible range	18 ... 30 V
	Power failure buffering	20 ms
Current consumption	200 mA + total current consumption of inputs, internal	
Protection class to EN 60 529	IP65	
Temperature range	Operation	-5 ... +50 °C
	Storage	-20 ... +70 °C
Materials	Housing	Die-cast aluminium
	Cover	Polyamide
Dimensions (HxWxD)	132 x 82 x 148 mm	
Grid dimension	72 mm	
Weight	1200 g	

DeviceNet is a rapid communication medium that is required for interlocking logic in decentralised automation units. Stand-alone manufacturing cells, started up separately and coupled via DeviceNet.

The DeviceNet scanner facilitates the connection of supplementary devices from manufacturers that are needed to realise the full functional scope of the control program of the control block – a quick and easy way of expanding functions.

Through the integration of the DeviceNet scanner 1747-SDN, in addition to the controller capabilities of the SLC500, the control block offers the greatest possible degree of flexibility in terms of installation on the DeviceNet.

- Can be used as a master in a network with subordinate slave stations
- Can be used as an intelligent slave station, with execution synchronisation with a higher-order master
- Can be used as an intelligent slave station with its own assigned slave devices for the expansion of functions

Modular electrical peripherals, for type 03/04

Technical data – Control block ISF60-03-DN

System overview – DeviceNet

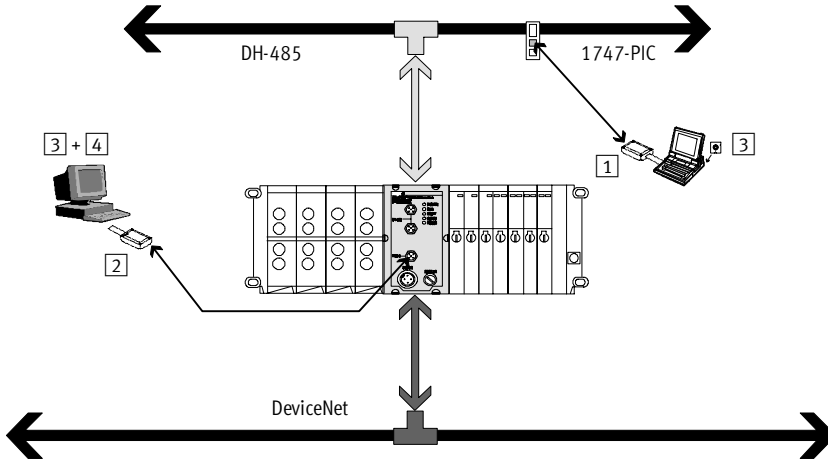

- 1 Interface converter 1747-PIC
- 2 Communication adapter 1770-KFD or 1784-PCD
- 3 Programming software RSNetWorx or RSLogix500
- 4 DeviceNetManager software version 3.004 or above

Connection and display components

The following connection and display components can be found on the control block cover:

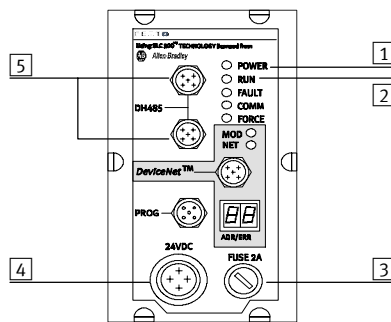

- 1 Green LED / POWER
- 2 Red LED / RUN
- 3 Fuse for operating voltage of inputs
- 4 Operating voltage connection
- 5 Plug for DH-485

DIP switch settings

Positioning of the DIP switches for the bus terminal and earth on the DH-485

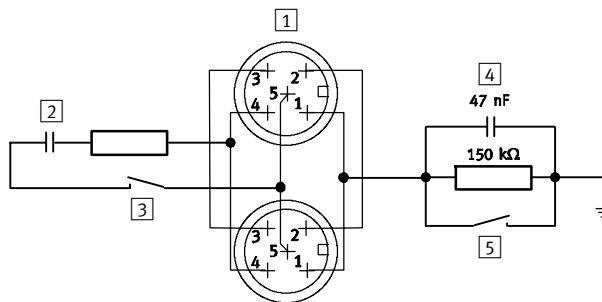

- 1 Connection of the DH-485 to the control block
- 2 DH-485 bus terminal
- 3 DIP switch 1
- 4 DH-485 earth
- 5 DIP switch 2

Pin allocation

Fieldbus interface

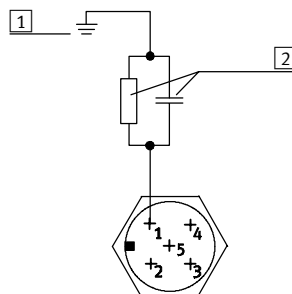





- 1 Screen/shield
- 2 Internal network

Modular electrical peripherals, for type 03/04

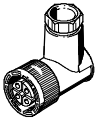
Accessories – Control block ISF60-03-DN

FESTO

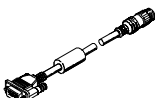
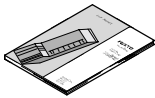
Ordering data				
Designation			Type	Part No.
Power supply				
	Plug socket, straight	for 1.5 mm ²	NTSD-GD-9	18 493
		for 2.5 mm ²	NTSD-GD-13,5	18 526
	Plug socket, angled	for 1.5 mm ²	NTSD-WD-9	18 527
		for 2.5 mm ²	NTSD-WD-11	533 119
Fieldbus connection				
	Plug socket, straight, 5-pin		FBSD-GD-9-5POL	18 324
	Plug, straight, 5-pin for T-adapter		FBS-M12-5GS-PG9	175 380
	T-adapter for DH-485		FB-TA-M12-5POL	171 175
Diagnostic/data connection				
	Programming cable	3 m	KDI-SB60-3,0-M12	171 173
		6 m	KDI-SB60-6,0-M12	175 686
		10 m	KDI-SB60-10,0-M12	171 174
	Cable for DTAM Micro	3 m	KDTAM-SB60-3-M12	188 979
		6 m	KDTAM-SB60-6-M12	188 980
		10 m	KDTAM-SB60-10-M12	188 981
User documentation				
	User documentation – Control block ISF60-03-DN	German	P.BE-VISB60-03-DE	184 572
		English	P.BE-VISB60-03-EN	184 573
		Spanish	P.BE-VISB60-03-ES	184 575

Modular electrical peripherals, for type 03/04

Technical data – Control block ISF3-03

FESTO

FESTO

A powerful mini controller from Festo has been integrated in the ISF3-03 control block and built into a robust aluminium housing with the protection class IP65. This permits stand-alone control of up to 128 inputs and outputs.



Application

All plugs and electrical connections are designed for direct mounting on the machine outside of the control cabinet (provided that the requirements of IP65 are adhered to).

With the Festo fieldbus, additional I/Os and expanded functions can be installed and controlled. The control block ISF3-03 can be operated as required in stand-alone mode, as a fieldbus slave or fieldbus master with up to 31 fieldbus slaves.

This controller is programmed via an RS232 programming interface using the software FST200. Alternatively, a display and control unit can be directly connected on-site.

The control block ISF3-03 is a highly compact solution; a stand-alone controller for directly mounted valve terminals of the type 03/04 or for CP valves and CP I/O modules indirectly connected via the CP installation system.

The elimination of internal wiring to the controller reduces the number of connection points required, thereby shortening the installation time and eliminating sources of potential errors.

The performance of the controller technology was selected and specially customised to meet the requirements of a valve terminal. Extensive diagnostic information provides information on the status of all components mounted on the valve terminal as well as the sensors and actuators connected to it.

Modular electrical peripherals, for type 03/04

Technical data – Control block ISF3-03



Operating modes

Stand-alone

Valve terminal with control block ISF3-03 for controlling a stand-alone machine. Can be used to autonomously control small stand-alone machines or system components. It can also be used to realise stand-alone subsystems with a discrete function as part of a larger system.

Master

Control block ISF3-03 with a fieldbus extension for controlling systems. The control block ISF3-03 with integrated fieldbus interface facilitates the connection of local inputs and outputs as well as further fieldbus stations. It can also be used to

process automation tasks requiring a large number of electrical sensors and actuators. It can also be used to realise stand-alone subsystems with a discrete function as part of a larger system.

General technical data

Type		ISF3-03	
Part No.		164 287	
Programming device interface		4-pin round plug for PC/ABG/serial coupling (V24/RS232)	
RAM and EEPROM program memory		128 kByte for program, modules, text modules and drivers (4-20 Byte = 1 instruction)	
Processing time for 1024 binary instructions		approx. 1 ms	
Flags		F0.0 to F31.15 = 512, all remanent	
	No. of time flags	T0 to T31 = 32 (timer preselection remanent)	
	Time range	0.01 s to 655.35 s	
	No. of counting flags	Z0 to Z31, all remanent	
	Counting range	0 to 65535	
Register		R0 to R127, R0 to R99 remanent	
Special FU		Function units 0 to 4096	
Arithmetic functions		+, -, *, :	
Inputs	digital	128	
	analogue	36	
Outputs	digital	128	
	analogue	12	
Programmable inputs/ outputs	CP	64 digital inputs/64 digital outputs incl. solenoid coils	
	Fieldbus	1048 I/O (per station, max. 128 I and 128 O)	
Permissible modules		Overview	
Programs		P 0 ... P 15 (user programs)	
Program modules		BAP 0 ... 15 (user programmable)	
Functional modules		BAF 0 ... 99	
	CFM No.	Application	
	0	Control block	Deletion of internal operands
	1		Location of short circuits
	2		Indirect set/reset of local outputs
	3		Indirect access to FU0 to FU4095
	4		Measurement of program runtime
	5		Reading of remanent data words
	6		Writing of remanent data words
	10		Assigning operation parameters/reading of counters/timers
	11		Interrupt-controlled enable/disable of counters/timers
	21	CP interface	Reading/writing of data CP auxiliary module
	23		Reset of all outputs accessible via CP
	25		Diagnosis of CP valve terminal, input and output modules
	27		Assigning operation parameters for CP errors
	28		Recording of CP configuration

Modular electrical peripherals, for type 03/04

Technical data – Control block ISF3-03



General technical data			
Type		ISF3-03	
Part No.		164 287	
	Functional modules		
	CFM No.	Application	
	31	AS-interface	Reading of AS-interface slave parameters
	32	master/AS-interface bus system	Writing of AS-interface slave parameters
	33		Reset of all outputs accessible via AS-interface bus
	35		Diagnosis of all AS-interface slaves
	37		Assigning operation parameters for control block for AS-interface errors
	38		Reconfiguration of the AS-interface bus
	40		Fieldbus
	41	Master/slave mode: Reading the parameters of a fieldbus station	
	42	Master/slave mode: Writing the parameters of a fieldbus station	
	43	Reset of all outputs accessible via fieldbus	
	44	Fieldbus station status request	
	47	Assigning operation parameters for fieldbus errors	
	48	Recording of actual configuration	
	49	Comparison of actual list with reference list	
	50	Reading of fieldbus station information	
	51	Fieldbus station reset	
	60	Analogue modules	
	61		Output of analogue values
	63		Diagnosis of analogue module
	90	Control block	Execution of assembler programs (functional modules)
	91		
	92		
	93		
	94		
	95		
	96		
	97		
	98		
	99		
Programming software		FESTO FST200	
Communication	Point to point coupling	Yes	
	Bus system	Festo fieldbus (master or slave), RS485	
Diagnosis		Comprehensive diagnosis, evaluation using FST200 or via inputs into user program	

Modular electrical peripherals, for type 03/04

Technical data – Control block ISF3-03



General technical data		
Type	ISF3-03	
Part No.	164 287	
Fieldbus interface	2x 4-pin round plug (RS485)	
Protocol	Festo fieldbus	
Cable length (dependent on baud rate)	Two wire cable, max. 500 ... 4000 m	
Bus address SF master	Permanent (master/slave mode set via FST200)	
Bus address SF slave	Can be set using FST200 (1 ... 31)	
Bus terminal	Can be set using FST200	
Communication SF slave	Max. 12 byte inputs and 12 byte outputs	
Bus station as master	Control block ISF3-03 1 master Max. 31 slaves: Festo valve terminals and digital modules	
Bus station as slave	Control block ISF3-03	
Data exchange (cyclic)	Max. 12 byte inputs and 12 byte outputs, via fieldbus I/O with Festo fieldbus master (e.g. ISF3-03, FPC405, ...)	
Data exchange (acyclic)	Parameter field, max. 256 words	
Parameter/configuration software for SF3 as master	Using a fieldbus configurator integrated in the FST200	
Diagnosis	Comprehensive diagnosis, evaluation using FST200 or via inputs into user program	
Operating voltage	Nominal value	24 V DC polarity-safe
	Permissible range	18 ... 30 V
	Power failure buffering	20 ms
Current consumption pin 1	Control block	200 mA
	CP modules	560 mA (internal electronics) + total current consumption of inputs
Current consumption pin 2	Total of all valves switched simultaneously, see technical data on CP valves	
Protection class to EN 60 529	IP65	
Temperature range	Operation	-5 ... +50 °C
	Storage	-20 ... +70 °C
Material	Housing	Die-cast aluminium
	Cover	Polyamide
Dimensions (HxWxD)	132 x 82 x 125 mm	
Weight	1000 g	

Modular electrical peripherals, for type 03/04

Technical data – Control block ISF3-03



Connection and display components

The following connection and display components can be found on the control block cover:

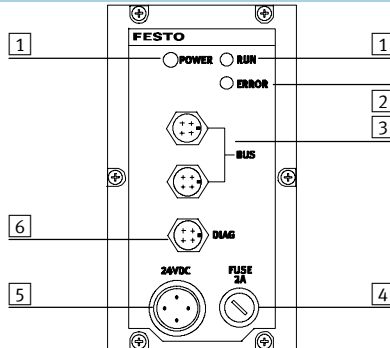

- 1 Green LEDs
- 2 Red LED
- 3 Plug for fieldbus cable
- 4 Fuse for operating voltage of inputs
- 5 Operating voltage connection
- 6 Diagnostic interface

Pin allocation for fieldbus interface

Terminal allocation	Pin No.	Signal
	1	Plug 1
	1	S+
	2	n.c.
	3	S-
	4	Screen/shield
	2	Plug 2
	1	S+
	2	n.c.
3	S-	
4	Screen/shield	
3	Internal network	
4	Housing/node	





Pin allocation for diagnostic interface

Terminal allocation	Pin No.	Signal
	1	RxD
	2	TxD
	3	GND
	4	Screen

Modular electrical peripherals, for type 03/04

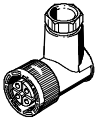
Accessories – Control block ISF3-03

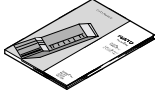

Ordering data				
Designation			Type	Part No.
Power supply				
	Plug socket, straight	for 1.5 mm ²	NTSD-GD-9	18 493
		for 2.5 mm ²	NTSD-GD-13,5	18 526
	Plug socket, angled	for 1.5 mm ²	NTSD-WD-9	18 527
		for 2.5 mm ²	NTSD-WD-11	533 119
Fieldbus connection				
	Bus connection, straight	PG7	FBSD-GD-7	18 497
		PG9	FBSD-GD-9	18 495
		PG13.5	FBSD-GD-13,5	18 496
	Bus connection, angled	PG7	FBSD-WD-7	18 524
		PG9	FBSD-WD-9	18 525
Diagnostic/data connection				
	Programming cable		KDI-SB202-BU9	150 268
User documentation				
	User documentation – FST200 programming software	German	P.BE-FST200-AWL/KOP-DE	165 484
		English	P.BE-FST200-AWL/KOP-EN	165 489
	User documentation – Control block ISF3-03	German	P.BE-VISF3-03-DE	165 481
		English	P.BE-VISF3-03-EN	165 486
		Spanish	P.BE-VISF3-03-ES	165 496
		French	P.BE-VISF3-03-FR	165 491
Italian	P.BE-VISF3-03-IT	165 446		

Modular electrical peripherals, for type 03/04

Technical data – Input module, digital, 4-/8-fold

FESTO

Function

Digital input modules facilitate the connection of proximity sensors or other 24 V DC sensors (inductive, capacitive, etc.).

Plugs with double allocation are separated using a DUO plug or DUO cable. These modules cannot be operated on the multi-pin node with inputs.

Applications

- Input modules for 24 V DC sensor signals
- M12 plug, single allocation connection technology in 4-fold modules, double allocation connection technology in 8-fold modules
- M12 plug, 5-pin
- The input statuses are indicated for each input signal at an allocated LED
- 24 V DC supply provided for all connected sensors
- Module width: 36 mm



General technical data			
Type	VIGE-03-FB-8-5POL	VIGE-03-FB-4-5POL	VIGE-03-FB-8,1-5POL
Part No.	175 555	175 557	175 559
Input type	Standard inputs, PNP	Input plug with single allocation, PNP	High-speed inputs, PNP
No. of inputs	8	4	8
No. of occupied module positions	1		
Sensor connection type	4xM12, 5-pin, socket with double allocation	4xM12, 5-pin, socket with single allocation	4xM12, 5-pin, socket with double allocation
Max. power supply per channel	2 A		
Max. sensor supply per module	2 A		
Fuse protection for sensor supply	Central fuse 2 A, in system supply		
Current consumption of module	Typical 12 mA		
Supply voltage of sensors	24 V DC $\pm 25\%$, coming from bus node		
Switching level	Signal 0	≤ 5 V	
	Signal 1	≥ 10 V	
Input delay	3 ms		0.6 ms
Switching logic	PNP (for input signals with positive logic)		
Input characteristic curve	To IEC 1131-2		
Protection class to EN 60 529	IP65 (when fully plugged-in or fitted with protective cover)		
Temperature range	Operation	$-5 \dots +50$ °C	
	Storage	$-20 \dots +70$ °C	
Material	Die-cast aluminium		
Dimensions	132 x 36 x 70 mm		
Grid dimension	36 mm		
Weight	360 g		

Modular electrical peripherals, for type 03/04

Technical data – Input module, digital, 4-/8-fold

FESTO

General technical data			
Type	VIGE-03-FB-8-5POL-S	VIGE-03-FB-8N	VIGE-03-FB-4N
Part No.	188 521	18 695	18 694
Input type	With separate fuse, PNP	Standard inputs, NPN	Input plug with single allocation, NPN
No. of inputs	8	8	4
No. of occupied module positions	1		
Sensor connection type	4xM12, 5-pin, socket with double allocation	4xM12	
Max. power supply per channel	2 A	2 A	
Max. sensor supply per module	0.5 A	2 A	
Fuse protection for sensor supply	Internal electrical fuse	Central fuse 2 A, in system supply	
Current consumption of module	Typical 12 mA	Typical 18 mA	
Supply voltage of sensors	24 V DC \pm 25%, coming from bus node		
Switching level	Signal 0	≤ 6 V	≤ 8.7 V
	Signal 1	≤ 8.6 V	≥ 8.4 V
Input delay	3 ms	5 ms	
Switching logic	PNP (for input signals with positive logic)	NPN (for input signals with negative logic)	
Input characteristic curve	To IEC 1131-2		
Protection class to EN 60 529	IP65 (when fully plugged-in or fitted with protective cover)		
Temperature range	Operation	-5 ... +50 °C	
	Storage	-20 ... +70 °C	
Material	Die-cast aluminium		
Dimensions	132 x 36 x 70 mm		
Grid dimension	36 mm		
Weight	360 g		

Modular electrical peripherals, for type 03/04

Technical data – Input module, digital, 4-/8-fold





Pin allocation							
Terminal allocation	4-fold			8-fold			
	Pin No.	Signal	LED	Pin No.	Signal	LED	
4-pin input modules (NPN)							
	1	+24 V	0	1	+24 V	0	
	2	n.c.		2	Ix+1		
	3	0 V		3	0 V		
	4	Ix		4	Ix		
	1	+24 V	1	1	+24 V	2	
	2	n.c.		2	Ix+3		
	3	0 V		3	0 V		
	4	Ix+1		4	Ix+2		
	1	+24 V	2	1	+24 V	4	
	2	n.c.		2	Ix+5		
	3	0 V		3	0 V		
	4	Ix+2		4	Ix+4		
	1	+24 V	3	1	+24 V	6	
	2	n.c.		2	Ix+7		
	3	0 V		3	0 V		
	4	Ix+3		4	Ix+6		
5-pin input modules							
	1	+24 V	0	1	+24 V	0	
	2	n.c.		2	Ix+1		
	3	0 V		3	0 V		
	4	Ix		4	Ix		
	5	Earth terminal		5	Earth terminal		
	1	+24 V	1	1	+24 V	2	
	2	n.c.		2	Ix+3		
	3	0 V		3	0 V		
	4	Ix+1		4	Ix+2		
	5	Earth terminal		5	Earth terminal		
	1	+24 V	2	1	+24 V	4	
	2	n.c.		2	Ix+5		
	3	0 V		3	0 V		
	4	Ix+2		4	Ix+4		
	5	Earth terminal		5	Earth terminal		
	1	+24 V	3	1	+24 V	6	
	2	n.c.		2	Ix+7		
	3	0 V		3	0 V		
	4	Ix+3		4	Ix+6		
	5	Earth terminal		5	Earth terminal		

Ix Input x

Modular electrical peripherals, for type 03/04

FESTO

Accessories – Input module, digital, 4-/8-fold

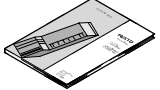
Ordering data				
Designation			Type	Part No.
Sensor plug				
	Plug, straight socket, M12	5-pin, PG7	SEA-M12-5GS-PG7	175 487
		4-pin, PG7	SEA-GS-7	18 666
		4-pin, 2.5 mm ² OD	SEA-4GS-7-2,5	192 008
	Plug for 2 sensor cables, M12, PG11	4-pin	SEA-GS-11-DUO	18 779
		5-pin	SEA-5GS-11-DUO	192 010
DUO cable				
	DUO cable	2x straight socket	KM12-DUO-M8-GDGD	18 685
		2x straight/angled socket	KM12-DUO-M8-GDWD	18 688
		2x angled socket	KM12-DUO-M8-WDWD	18 687
User documentation				
	Manual for input/output modules	German	P.BE-VIEA-03-DE	371 189
		English	P.BE-VIEA-03-EN	371 190
		French	P.BE-VIEA-03-FR	377 786
		Spanish	P.BE-VIEA-03-ES	371 191
		Italian	P.BE-VIEA-03-IT	371 192
		Swedish	P.BE-VIEA-03-SV	371 193

Modular electrical peripherals, for type 03/04

Technical data – Input module, digital, 16-fold

FESTO

Function

Sensor signals in groups of up to 8 or 12 are recorded by multi-pin distributors and forwarded to the module via a multi-pin cable.

Applications

- Input modules for 24 V DC sensor signals
- 2 connector plugs, Sub-D 15-pin socket
- Ready for installation for multi-pin distributors with up to 8 or 12 inputs
- Allocation of the plug variables
 - 8 inputs on top and 8 inputs on bottom
 - 12 inputs on top and 4 inputs on bottom
- The input statuses are indicated for each input signal at an assigned LED
- 24 V DC voltage supplied separately for both plugs, with separate electronic fuse
- Module width: 36 mm



General technical data		
Type		VIGE-03-FB-16-SUBD-S
Part No.		192 549
No. of inputs		16
No. of occupied module positions		2
Sensor connection type		2x Sub-D, 15-pin socket
Max. sensor supply per connection		0.5 A
Max. sensor supply per module		1 A
Fuse protection for sensor supply		Separate electronic fuse for each connection
Current consumption of module		12 mA
Supply voltage of sensors		24 V DC ±25%, coming from bus node
Switching level	Signal 0	≤6 V
	Signal 1	≥8.6 V
Input delay		3 ms
Switching logic		PNP (for input signals with positive logic)
Input characteristic curve		To IEC 1131-2
Protection class to EN 60 529		IP65 (when fully plugged-in or fitted with protective cover)
Temperature range	Operation	–5 ... +50 °C
	Storage	–20 ... +70 °C
Material		Die-cast aluminium
Dimensions (HxWxD)		132 x 36 x 56 mm
Grid dimension		36 mm
Weight		360 g

Modular electrical peripherals, for type 03/04

Technical data – Input module, digital, 16-fold



Pin allocation		16-fold	
Terminal allocation		Pin No.	Signal
	1	1	Ix
	2	2	Ix+1
	3	3	Ix+2
	4	4	Ix+3
	5	5	Ix+4
	6	6	Ix+5
	7	7	Ix+6
	8	8	Ix+7
	9	9	Ix+8 ¹⁾
	10	10	Ix+9 ¹⁾
	11	11	Ix+10 ¹⁾
	12	12	Ix+11 ¹⁾
	13	13	24 V sensor supply
	14	14	0 V
	15	15	PE housing
	1	1	Ix+8 ¹⁾
	2	2	Ix+9 ¹⁾
	3	3	Ix+10 ¹⁾
	4	4	Ix+11 ¹⁾
	5	5	Ix+12
	6	6	Ix+13
	7	7	Ix+14
	8	8	Ix+15
	9	9	Free
	10	10	Free
	11	11	Free
	12	12	Free
	13	13	24 V sensor supply
	14	14	0 V
	15	15	PE housing

Ix Input x

1) Two sets of inputs signals, connect to either of the two plugs.

Modular electrical peripherals, for type 03/04

Accessories – Input module, digital, 16-fold

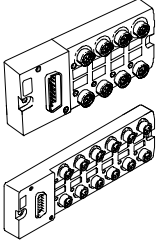
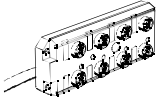
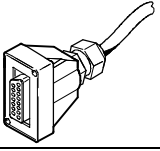
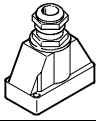
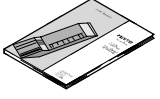

Ordering data				
Designation			Type	Part No.
Multi-pin distributors			Technical data → 4 / 4.8-185	
	Multi-pin distributor, 3-pin M8 plug	8 I/Os	MPV-E/A08-M8	177 669
		12 I/Os	MPV-E/A12-M8	177 670
	Multi-pin distributor with connecting cable, 5-pin M12 plug	8 I/Os	MPV-E/A08-M12	177 671
Cables and plugs				
	Plug socket with cable, open at one end	5.0 m	KMPV-SUB-D-15-5	177 673
		10.0 m	KMPV-SUB-D-15-10	177 674
	Plug socket Sub-D, plug		SD-SUB-D-ST15	192 768
User documentation				
	Manual for input/output modules	German	P.BE-VIEA-03-DE	371 189
		English	P.BE-VIEA-03-EN	371 190
		French	P.BE-VIEA-03-FR	377 786
		Spanish	P.BE-VIEA-03-ES	371 191
		Italian	P.BE-VIEA-03-IT	371 192
		Swedish	P.BE-VIEA-03-SV	371 193

Modular electrical peripherals, for type 03/04

Technical data – Output module, digital



Function

The electrical outputs control actuators such as individual valves, hydraulic valves, heating controllers and many more. Separate electrical circuits are realised, or high-current outputs of up to 25 A supplied, by means of an additional power supply.

 Note
Valves with M12 central plug, optimum control.

Applications

- Output module with 4 outputs
24 V DC
- M12 connection technology, with 5-pin sockets
- LED display of the switching status per channel
- Short circuit and overload detection per output
 - Separate malfunction display for each channel by means of red LED
 - Diagnostic message about system status to controller
- High-current outputs 2 A per output, in conjunction with power supply module
- Numerous separate load circuits can be realised
- Parallel connection of max. 4 outputs in an output module
- Power supply module permits electrical disconnection from central output supply



General technical data			
Type	VIGA-03-FB-4-5POL	VIGA-03-FB-4-PH	VIGA-03-FB-4-NH
Part No.	175 641	18 968	172 936
Output type	Standard outputs, PNP	High-current output, PNP	High-current output, NPN
No. of outputs	4		
No. of occupied module positions	1		
Output connection type	4xM12, 5-pin, socket with double allocation	4xM12, 4-pin, socket with double allocation	
Max. output current	per channel	0.5 A	2.0 A
	per module	2.0 A	8.0 A
Operating voltage	24 V DC ±25%		
Load voltage connection	24 V DC ±10%		
Parallel connection possible	Yes, within the module only		
Fuse protection for output line	Electronic fuse per channel	Electronic fuse per channel 2 A	
	0.5 A		
Current consumption of module	9 mA	100 mA	
Overload/short circuit protection	per channel		
Switching logic	To IEC 1131-2		
Protection class to EN 60 529	IP65 (when fully plugged-in or fitted with protective cover)		
Temperature range	Operation	–5 ... +50 °C	
	Storage	–20 ... +70 °C	
Material	Die-cast aluminium		
Dimensions (HxWxD)	132 x 36 x 69 mm		
Grid dimension	36 mm		
Weight	360 g		

Modular electrical peripherals, for type 03/04

Technical data – Output module, digital

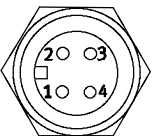
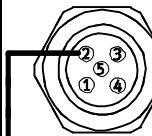
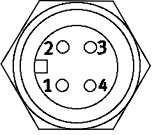
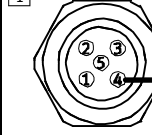
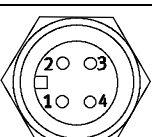
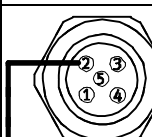
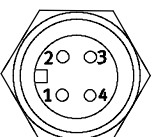
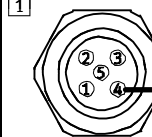
4-fold				5-fold			
Terminal allocation	Pin No.	Signal	LED	Terminal allocation	Pin No.	Signal	LED
	1	n.c.	0		1	n.c.	0
	2	n.c.			2	Ox+1	
	3	0 V			3	0 V	
	4	Ox			4	Ox	
			5		Earth terminal; only with type VIGA-03-FB-4-5POL		
	1	n.c.	1		1	n.c.	1
	2	n.c.			2	n.c.	
	3	0 V			3	0 V	
	4	Ox+1			4	Ox+1	
			5		Earth terminal; only with type VIGA-03-FB-4-5POL		
	1	n.c.	2		1	n.c.	2
	2	n.c.			2	Ox+3	
	3	0 V			3	0 V	
	4	Ox+2			4	Ox+2	
			5		Earth terminal; only with type VIGA-03-FB-4-5POL		
	1	n.c.	3		1	n.c.	3
	2	n.c.			2	n.c.	
	3	0 V			3	0 V	
	4	Ox+3			4	Ox+3	
			5		Earth terminal; only with type VIGA-03-FB-4-5POL		

1 Internal connection in module
Ox Output x

Modular electrical peripherals, for type 03/04

Technical data – Output module, digital



PNP 4-fold				NPN 4-fold			
Terminal allocation	Pin No.	Signal	LED	Terminal allocation	Pin No.	Signal	LED
	1	Ox+1	0		1	+24 V ¹⁾	0
	2	Earthing			2	Earthing	
	3	0 V			3	Ox+1	
	4	Ox			4	Ox	
	1	n.c.	1		1	+24 V ¹⁾	1
	2	Earthing			2	Earthing	
	3	0 V			3	n.c.	
	4	Ox+1			4	Ox+1	
	1	Ox+3	2		1	+24 V ¹⁾	2
	2	Earthing			2	Earthing	
	3	0 V			3	Ox+3	
	4	Ox+2			4	Ox+2	
	1	n.c.	3		1	+24 V ¹⁾	3
	2	Earthing			2	Earthing	
	3	0 V			3	n.c.	
	4	Ox+3			4	Ox+3	

1) Internal connection in module

Ox Output x

1) Consuming devices/load must be supplied via this 24 V connection

Modular electrical peripherals, for type 03/04

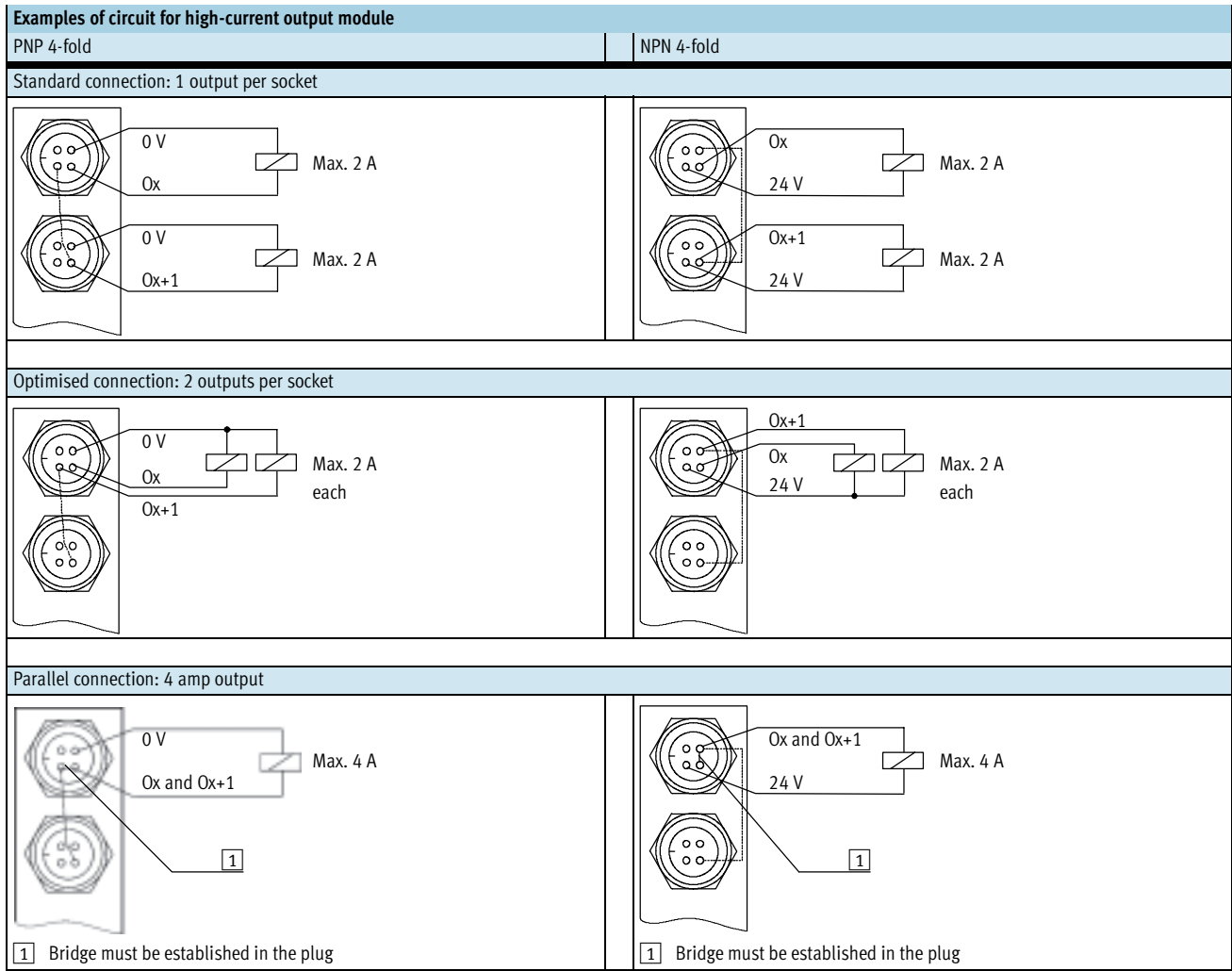

Technical data – Output module, digital



Modular electrical peripherals, for type 03/04

Accessories – Output module, digital

FESTO

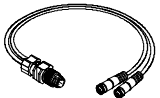
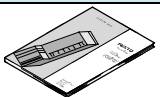
Ordering data				
Designation			Type	Part No.
Sensor plug				
	Plug, straight socket, M12	5-pin, PG7	SEA-M12-5GS-PG7	175 487
		4-pin, PG7	SEA-GS-7	18 666
		4-pin, 2.5 mm ² OD	SEA-4GS-7-2,5	192 008
	Plug for 2 sensor cables, M12, PG11	4-pin	SEA-GS-11-DUO	18 779
		5-pin	SEA-5GS-11-DUO	192 010
DUO cable				
	DUO cable	2x straight socket	KM12-DUO-M8-GDGD	18 685
		2x straight/angled socket	KM12-DUO-M8-GDWD	18 688
		2x angled socket	KM12-DUO-M8-WDWD	18 687
User documentation				
	Manual for input/output modules	German	P.BE-VIEA-03-DE	371 189
		English	P.BE-VIEA-03-EN	371 190
		French	P.BE-VIEA-03-FR	377 786
		Spanish	P.BE-VIEA-03-ES	371 191
		Italian	P.BE-VIEA-03-IT	371 192
		Swedish	P.BE-VIEA-03-SV	371 193

Modular electrical peripherals, for type 03/04

Technical data – Additional power supply for high-current outputs

FESTO

Function

The power supply module supplies high-current output modules attached on the left with a load current of up to max. 25 A or disconnects the modules attached on the left from the load current circuit of a preceding power supply module.

Several power supply modules can be used in the electrical peripherals.

High-current output modules of the type HC-Output (PNP) and HC-Output-N (NPN) can be used next to each other in any order. Additional electrical power supply ends at the last high-current output module. Other I/O modules can be used downstream from that point.



General technical data		
Type		VIGV-03-FB-24V-25A
Part No.		18 969
No. of occupied module positions		0
Connection plug type		Terminal strip with IP65 cover
Operating voltage connection		24 V DC $\pm 25\%$
Current consumption of module		7 mA
Max. supply current per module		25 A
Fuse protection for supply		External blade-type fuse
Protection class to EN 60 529		IP65 (when fully plugged-in or fitted with protective cover)
Temperature range	Operation	-5 ... +50 °C
	Storage	-20 ... +70 °C
Material		Die-cast aluminium
Dimensions (HxWxD)		132 x 36 x 95 mm
Grid dimension		36 mm
Weight		440 g

Modular electrical peripherals, for type 03/04

Technical data – Additional power supply for high-current outputs



Mounting the additional power supply

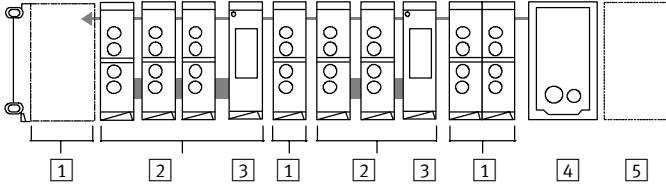

- | | | |
|----------------------------------------------------------------------------------------------------|--------------------------------------------------------------------------------------------------------------------------------------|---------------------------------------------------------------------------|
| <p>1 I/O modules 4/8 inputs (PNP/NPN) or 4 outputs (only PNP 0.5 A) or multi I/O module 12I/80</p> | <p>2 High-current output (PNP/NPN) 2x high-current supply (grey connection) terminates after the last high-current output module</p> | <p>3 Additional power supply 24 V/25 A</p> <p>4 nodes</p> <p>5 valves</p> |
|----------------------------------------------------------------------------------------------------|--------------------------------------------------------------------------------------------------------------------------------------|---------------------------------------------------------------------------|

Terminal allocation – Additional power supply

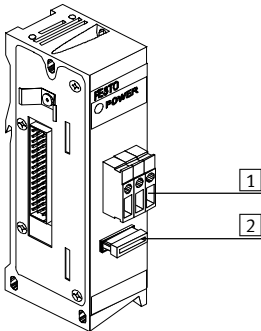

- | |
|-----------------------------------------------------------------------|
| <p>1 Terminals</p> <p>2 Blade-type fuse 25 A (motor vehicle fuse)</p> |
|-----------------------------------------------------------------------|

Modular electrical peripherals, for type 03/04

Technical data – Input/output module



Function

Digital input modules facilitate the connection of proximity sensors or other 24 V DC sensors (inductive, capacitive, etc.).
The electrical outputs control actuators such as individual valves, lamps and a host of other devices. The I/O module occupies 3 module positions.
Its electrical isolation makes it suitable as a coupling connection to external circuits.

Applications

The I/O module combines 12 inputs and 8 outputs in one module with a width of 72 mm. The connection is established via a pre-assembled 25-pin Sub-D plug with multi-pin cable. 24 V DC internal supply to the sensor connections. The switching status displays for the inputs/outputs are shown on assigned LEDs. 4 outputs are combined into a group and supplied externally with 24 V DC. The inputs and outputs are electrically isolated from the node.



General technical data			
Type	VIEA-03-FB-12E-8A-SUBD		VIEA-03-FB-12E-8A-N-SUBD
Part No.	174 483		174 485
Number	Inputs	12	
	Outputs	8	
No. of occupied module positions	3		
Sensor connection and output type	25-pin multi-pin cable and Sub-D plug connector		
Max. power supply per channel	2 A		
Max. sensor supply per module	2 A		
Fuse protection for sensor supply	Central fuse 2 A, in system supply		
Current consumption of module	Typically 8 mA (inputs) 5 mA (outputs) per group of four		
Capacity per digital output	0.5 A internal electronic fuse		
Supply voltage of sensors	24 V DC $\pm 25\%$, coming from bus node		
Switching level	Signal 0	≤ 5 V	≤ -5 V
	Signal 1	≥ 11 V	≤ -11 V
Input delay	5 ms		
Switching logic	PNP (for input signals with positive logic)		NPN (for input signals with negative logic)
Input characteristic curve	To IEC 1131-2		
Protection class to EN 60 529	IP65 (when fully plugged-in or fitted with protective cover)		
Temperature range	Operation	$-5 \dots +50$ °C	
	Storage	$-20 \dots +70$ °C	
Material	Die-cast aluminium		
Dimensions (HxWxD)	132 x 78 x 78 mm		
Grid dimension	72 mm		
Weight	700 g		

Modular electrical peripherals, for type 03/04

Technical data – Input/output module





Pin allocation					
Terminal allocation – Plug on I/O module	Pin No.	Signal		Core colour of data cable KEA-1-25P-...	
		PNP	NPN		
	1	Ix		white	
	2	Ix+1		green	
	3	Ix+2		yellow	
	4	Ix+3		grey	
	5	Ix+4		pink	
	6	Ix+5		blue	
	7	Ix+6		red	
	8	Ix+7		magenta	
	9	Ix+8		grey-pink	
	10	Ix+9		red-blue	
	11	Ix+10		white-green	
	12	Ix+11		brown-green	
	13	0 V of inputs	24 V of outputs		white-yellow
	14	Ox		yellow-brown	
	15	Ox+1		white-grey	
	16	Ox+2		grey-brown	
	17	Ox+3		white-pink	
	18	Ox+4		pink-brown	
	19	Ox+5		white-blue	
	20	Ox+6		brown-blue	
	21	Ox+7		white-red	
	22	24 V (for the outputs Ox ... Ox+3)		brown-red	
	23	24 V (for the outputs Ox+4 ... Ox+7)		white-black	
	24	0 V (for the outputs Ox ... Ox+3)		brown	
	25	0 V (for the outputs Ox+4 ... Ox+7)		black	

Modular electrical peripherals, for type 03/04

Accessories – Input/output module

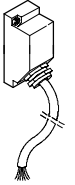

Ordering data				
Designation			Type	Part No.
Cables and plugs				
	Connecting cable	5 m	KEA-1-25P-5	177 413
		10 m	KEA-1-25P-10	177 414
		x length	KEA-1-25P-X	177 415
	Plug socket Sub-D, socket		SD-SUB-D-BU25	18 709
User documentation				
	Manual for input/output modules	German	P.BE-VIEA-03-DE	371 189
		English	P.BE-VIEA-03-EN	371 190
		French	P.BE-VIEA-03-FR	377 786
		Spanish	P.BE-VIEA-03-ES	371 191
		Italian	P.BE-VIEA-03-IT	371 192
		Swedish	P.BE-VIEA-03-SV	371 193

Modular electrical peripherals, for type 03/04

Technical data – Analogue stage



Function

Analogue signals, as well as digital inputs and outputs, are required in many areas of automation. Special analogue stages are provided for these tasks which are capable of processing both analogue input signals, e.g. setpoint specifications and feedback on actual values (temperature, pressure, flow rate, fill-level, etc.), as well as analogue outputs for controlling actuators. The analogue stages are specially prepared for the connection of proportional valves.

Applications

- 6-pin push-in connectors to DIN 45 332
 - Diagnostic LED to indicate readiness for service and overload
 - Voltage supplied for all connected sensors
- Three analogue stages are available for different fields of application:
- VIAP-03-FB, optimised for proportional valves
 - 1 analogue input (4 ... 20 mA)
 - 1 analogue output (4 ... 20 mA)
 - VIAU-03-FB-I, universal module for current signals
 - 3 analogue inputs (4 ... 20 mA)
 - 1 analogue output (4 ... 20 mA)
 - VIAU-03-FB-U, universal module for voltage signals
 - 3 analogue inputs (0 ... 10 V)
 - 1 analogue output (0 ... 10 V)



VIAP-03-FB

VIAU-03-FB-...

General technical data			
Type	VIAP-03-FB	VIAU-03-FB-I	VIAU-03-FB-U
Part No.	18 691	164 239	18 692
Number	Inputs	1	3
	Outputs	1	1
Sensor connection type	1x 6-pin socket, DIN 45 322	3x 6-pin socket, DIN 45 322	
Max. sensor supply per module	2 A		0.5 A
Fuse protection for sensor supply	Central fuse 2 A, in system supply		
Current consumption of module	64 mA		
Supply voltage of sensors	24 V DC ±25%, coming from bus node		
Actuator supply voltage	24 V DC ±10%, external		
Actuator supply, average continuous loading capability	Max. 0.5 A	Max. 1 A	
Analogue current inputs	Signal range	4 ... 20 mA	0 ... 10 V
	Resolution	11 bit	12 bit
	No. of units	2 048	4 096
	Absolute precision	0.45%	0.4%
	Input resistance	50 Ω	≥ 20 kΩ
	Max. permissible input current	65 mA	
	Input voltage	–	
Input signal cut-off frequency	100 Hz	116 Hz	
Linearity	Differential non-linearity	2 LSB	
	Integral non-linearity	3 LSB	

Modular electrical peripherals, for type 03/04

Technical data – Analogue stage

General technical data			
Type		VIAP-03-FB	VIAU-03-FB-I
Part No.		18 691	164 239
Analogue current outputs	Signal range	4 ... 20 mA	
	Resolution	12 bit	
	No. of units	4 096	
	Absolute precision	0.5%	0.45%
	Load resistance (load)	≤ 250 Ω	≥ 3.3 kΩ
Linearity	Differential non-linearity	2 LSB	
	Integral non-linearity	4 LSB	
Protection class to EN 60 529		IP65 (when fully plugged-in or fitted with protective cover)	
Temperature range	Operation	-5 ... +50 °C	
	Storage	-20 ... +70 °C	
Material		Die-cast aluminium	
Dimensions (HxWxD)		132 x 42 x 70 mm	
Grid dimension		36 mm	
Weight		360 g	

Pin allocation		
Terminal allocation	Signal	Signal designation
Analogue stage VIAP-03-FB		
	IIO+	Positive current, input signal
	IIO-	Negative current, input signal
	OIO+	Positive current, output signal
	OGND	Current output signal
	24 V _p	24 V actuator supply voltage
	0 V	0 V actuator supply voltage
	Housing	Cable screening connection

Modular electrical peripherals, for type 03/04

Technical data – Analogue stage





Pin allocation			Signal	Signal designation
Terminal allocation				
Analogue stage VIAU-03-FB-I (current signals)				
	I10-	n.c.	I1x+	Positive current, input signal
	I10+	24 V _{Sen}	I1x-	Negative current, input signal
	0 V	n.c.	O10+	Positive current, output signal
			OGND	Current output signal
			24 V _{Sen}	24 V sensor supply voltage
			24 V _p	24 V actuator supply voltage
			0 V	0 V actuator/sensor supply voltage
			Housing	Cable screening connection
Analogue stage VIAU-03-FB-U (voltage signals)				
	n.c.	IU0+	IUx+	Positive voltage, input signal
	n.c.	24 V _{Sen}	IU0-	Negative voltage, input signal
	0 V		IU1+	Positive voltage, output signal
			IU1-	Voltage output signal
			24 V _{Sen}	24 V sensor supply voltage
			24 V _p	24 V actuator supply voltage
			0 V	0 V actuator/sensor supply voltage
			Housing	Cable screening connection

Modular electrical peripherals, for type 03/04

FESTO

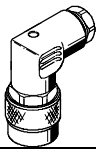
Accessories – Analogue stage

Ordering data				
Designation		Type	Part No.	
Connecting cables				
	Connecting cable for Festo proportional pressure regulator, plug/socket pre-assembled at both ends	5 m	KVIA-MPPE-5	163 882
		10 m	KVIA-MPPE-10	163 883
	Connecting cable for Festo proportional directional control valve, plug/socket pre-assembled at both ends	5 m	KVIA-MPYE-5	161 984
		10 m	KVIA-MPYE-10	161 985
	Connecting cable for other signal modules, open cable end	5 m	KVIA-5	163 960
		10 m	KVIA-10	163 961
User documentation				
	User documentation – Analogue stage	German	P.BE-VIAX-03/05-DE	163 946
		English	P.BE-VIAX-03/05-EN	163 947
		French	P.BE-VIAX-03/05-FR	163 948
		Spanish	P.BE-VIAX-03/05-ES	163 949
		Italian	P.BE-VIAX-03/05-IT	165 379
		Swedish	P.BE-VIAX-03/05-SV	165 539

Modular electrical peripherals, for type 03/04

Technical data – Electrical interface for CP interface

Function

The CP interface electrical interface module establishes the connection to a CP installation system. I/O data from the CP installation system is transferred to the connected bus node, and then to the higher-order controller via the fieldbus.

As well as transmitting the communication data, the max. 4 CP strings also transmit the supply voltage to the connected sensors and the load supply to the valves. The two circuits are isolated and are supplied with power by the connected bus node or control block.

An exact description of the CP installation system is provided in Info 221.

Applications

The following bus nodes/control blocks support the CP interface electrical interface.

Bus nodes:

- IFB8-03 1771 Remote I/O
- IFB16-03 ASA (FIPIO) bus

The CP interface electrical interface occupies one bus node exclusively. Additional local valves or further electrical I/O modules cannot be connected.

Control blocks:

- ISF3-03 Festo machine controller
- ISB60-03, ISF60-03-DN SLC 500 controller from Allen Bradley

Further local valves or electrical I/Os can be connected.



General technical data		VIGCP-03-FB
Type		18 229
Part No.		
Brief description		CP interface
Max. no. of CP modules per string		1 output module or valve terminal and 1 input module
Number	CP strings	4
	Outputs	64
	Inputs	64
	Occupied module positions	1
Cycle time		< 5 ms at full expansion
Current consumption		90 mA
Protection class to EN 60 529		IP65 (when fully plugged-in or fitted with protective cover)
Temperature range	Operation	+5 ... +70 °C
	Storage	-20 ... +70 °C
Material		Die-cast aluminium
Dimensions (HxWxD)		132 x 36 x 53 mm
Grid dimension		36 mm
Weight		310 g

Modular electrical peripherals, for type 03/04

Technical data – Electrical interface for CP interface

Connection and display components

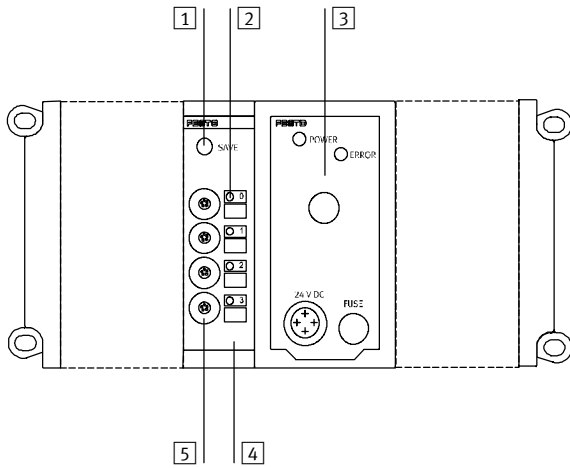

- 1 SAVE key
- 2 String error LEDs
- 3 Control block ISF3-03
- 4 Inscription areas
- 5 CP connections for up to 4 strings (0 ... 3)

Example of circuit

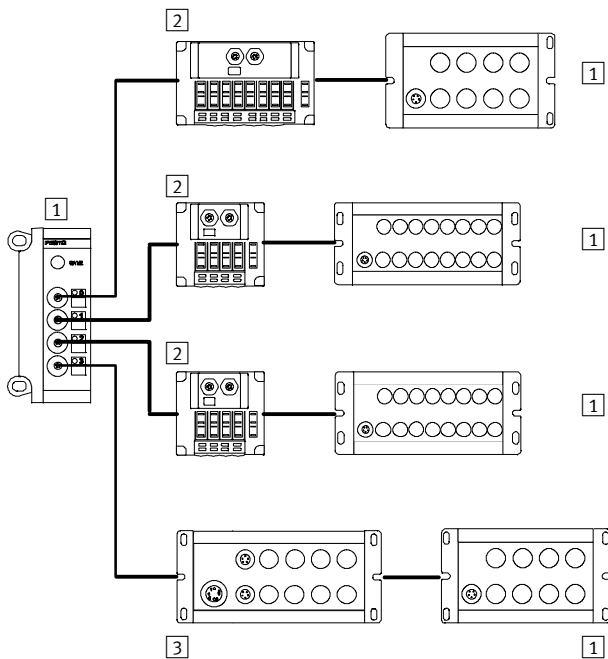

- 1 CP input module
- 2 Valve terminals type 10 CPV and type 12 CPA, Compact Performance
- 3 CP output module

You will find further information

- ➔ 4 / 2.1-2 for valve terminal type 10 CPV, Compact Performance
- ➔ 4 / 2.1-79 for valve terminal type 12 CPA, Compact Performance
- ➔ 4 / 4.6-2 for electrical installation system, for CPV/CPA

Modular electrical peripherals, for type 03/04

Technical data – Electrical interface for AS-interface master

Function

This module, in conjunction with a bus node or control block, controls an AS-interface network.

The slave stations connected to the module are organised by the AS-interface master, their inputs and outputs are either transferred to the higher-order controller via the connected fieldbus or forwarded directly to the control block.

The AS-interface is configured using the software tool provided or the configuration plug.

In order to install the AS-interface, the master together with the required slaves are connected to the yellow flat cable. Each station is first assigned a unique address.

The AS-interface combi power pack also supplies the power supply for all stations via the yellow data cable (note the total current of all connected devices).

Once the connections have been established and unique addresses have been selected without any overlapping, the current configuration can be read in and saved by means of the configuration plug.

Bus station inputs and outputs are then cyclically updated and exchanged with the higher-order bus node or control block. Each station as well as the AS-interface diagnostic data are assigned a fixed address field for their I/Os.

Applications

The following bus nodes and control blocks support the AS-interface master.

- IFB6-03 Interbus
- IFB13-03 Profibus
- IFB21-03 Interbus-FOC "Rugged Line"
- ISF3-03 Festo machine controller
- ISB60-03, ISF60-03-DN SLC 500 controller from Allen Bradley



General technical data		VIASI-03-M
Type		18 721
Part No.		18 721
Specification		Standard master
Max. no. of slave stations that can be connected		31
Number	Outputs	124
	Inputs	124
	Occupied module positions	1
Diagnostic interface type		RS232, floating, M12, 5-pin
AS-interface connection plug type		Flat cable socket
Cycle time		5 ms at full expansion
Current consumption via fieldbus node supply		165 mA
Current consumption from AS-interface power pack		65 mA
Input delay		3 ms
Protection class		IP65
Protection class to EN 60 529		IP65 (when fully plugged-in or fitted with protective cover)
Temperature range	Operation	+5 ... +50 °C
	Storage	-20 ... +70 °C
Material		Die-cast aluminium
Dimensions (HxWxD)		132 x 42 x 70 mm
Grid dimension		72 mm
Weight		700 g

Modular electrical peripherals, for type 03/04

Technical data – Electrical interface for AS-interface master



Connection and display components

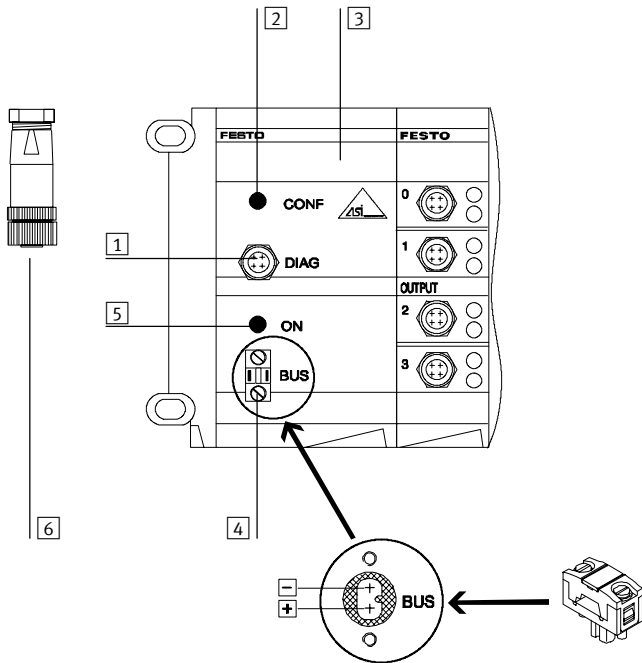

- 1 Diagnostic interface V.24/RS232
- 2 Yellow LED (configuration)
- 3 Master inscription area
- 4 Bus connection with flat cable socket (included in scope of delivery)
Polarity:
- = light blue
+ = brown
- 5 Green LED (bus voltage)
- 6 Configuration plug (not included in scope of delivery)
The configuration plug ASI-SS-CONFIG is required for straightforward commissioning (with PC/software tool).







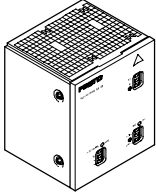

Pin allocation for diagnostic interface

Terminal allocation	Pin No.	Signal
	1	RxD
	2	TxD
	3	GND
	4	Screen

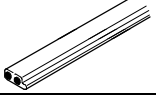
Modular electrical peripherals, for type 03/04



Accessories – Electrical interface for AS-interface master

Ordering data				
Designation		Type	Part No.	
AS-Interface				
	Combi power pack	ASI-CNT-115/230AC-B	191 082	
	Cable distributor, cable parallel rotatable	ASI-KVT-FK	18 786	
	Cable distributor, cable symmetrical	ASI-KVT-FK-S	18 797	
	Flat cable (standard cable, yellow)	KASI-1,5-Y-100	18 940	
	Flat cable (additional power supply, black)	KASI-1,5-Z-100	18 941	
	AS-interface configuration plug	ASI-SS-CONFIG	18 961	
	Cable socket for bus and voltage supply connection, M12, flat	ASI-SD-FK-M12	18 788	
	Cable socket, flat	ASI-SD-FK	18 785	
	Cable socket, flat, cable rotated 180° (upside-down)	ASI-SD-FK180	196 089	
	Programming cable for AS-interface software tool, serial	KDI-SB202-BU9	150 268	
User documentation				
	User documentation – Electrical interface for AS-interface master	German	P.BE-VIASI-03/05-DE	163 942
		English	P.BE-VIASI-03/05-EN	163 943
		French	P.BE-VIASI-03/05-FR	163 944
		Spanish	P.BE-VIASI-03/05-ES	163 945
		Italian	P.BE-VIASI-03/05-IT	165 536
		Swedish	P.BE-VIASI-03/05-SV	165 538

Modular electrical peripherals, for type 03/04

Technical data – Multi-pin distributor

Function

MPV multi-pin distributors are suitable for the distribution of input and output signals to sensors and valves via the M12/M8 plugs. The multi-pin distributors, in conjunction with the input module VIGE-03-FB-16-SUBD-S (→ 4 / 4.8-163), collect the sensor signals directly in the machine and forward them to the input module on the 15-pin Sub-D sockets via a multi-pin cable.

- LED for signal status display
- Only one cable to installation location
- A broad range of accessories

Type MPV-E/A...-M8

The multi-pin distributor facilitates the connection of max. 8 or 12 input signals to 3-pin M8x1 plugs. The connecting cable KMPV-SUB-D-15-..., pre-assembled at one end, with the 15-pin Sub-D socket is connected to the multi-pin distributor. The open end of the cable is fitted with the plug socket SD-SUB-D-ST15 and connected to the input module.

Type MPV-E/A08-M12

Connection of max. 8 input signals to 5-pin M12 plug. The connecting cable is permanently attached to the multi-pin distributor. The open end of the cable is fitted with the plug socket SD-SUB-D-ST15 and connected to the input module. Switching status display via yellow LED. Sensor voltage display via green LED.

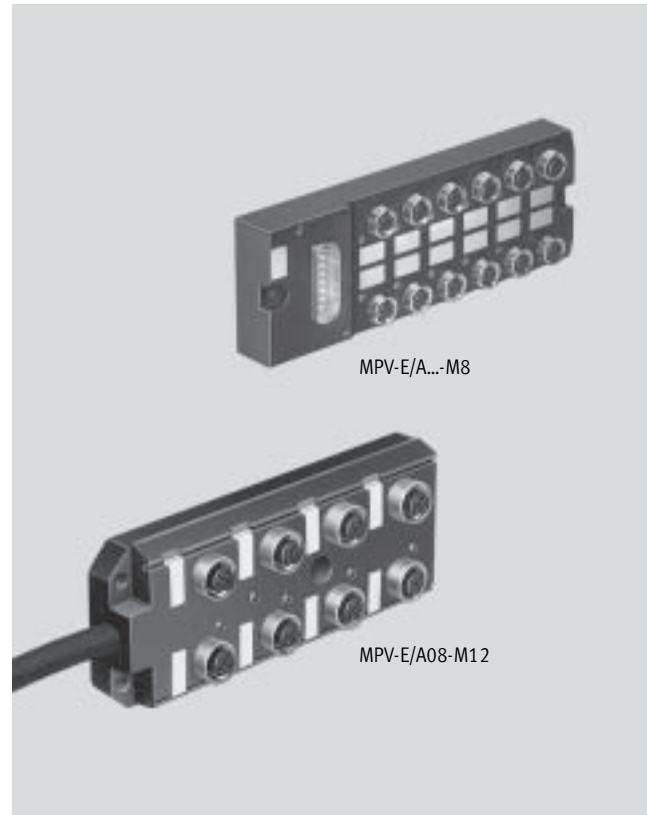

General technical data			
Type	MPV-E/A08-M8	MPV-E/A12-M8	MPV-E/A08-M12
Part No.	177 669	177 670	177 671
No. of inputs/outputs	8	12	8
Type of mounting	2 through-holes or on H-rail ¹⁾		3 through-holes
Connection	M8x1, 3-pin		M12x1, 5-pin
Permissible voltage	10 ... 30 V DC		10 ... 30 V DC
Current-carrying capacity	Max. 1 A per module slot Total current: max. 4 A		Max. 4 A per module slot Total current: max. 12 A
Protection class to EN 60 529	IP65 (fully assembled)		IP67 (fully assembled)
Temperature range	Operation	-20 ... +80 °C	
	Storage	-20 ... +80 °C	
Materials	Housing	Polyamide	
	Sockets	Brass, nickel plated	
	Cable	-	
Weight	100 g ²⁾	120 g ²⁾	200 g ²⁾

1) With adapter CP-TS-HS-35

2) Without cable

Modular electrical peripherals, for type 03/04

Technical data – Multi-pin distributor

Dimensions

Download CAD data → www.festo.com/en/engineering

MPV-E/A...-M8

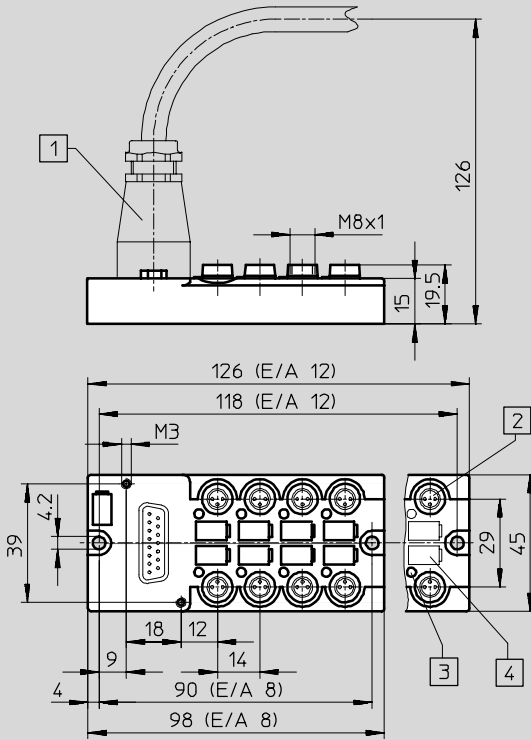

- 1 Multi-pin connection
- 2 3-pin socket, M8x1
- 3 Switching status display, yellow
- 4 Inscription label (type IBS-6x10)

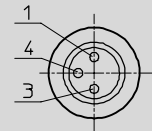

- 1 24 V DC
- 3 0 V
- 4 Signal line (1 ... 8) or (1 ... 12)

MPV-E/A08-M12

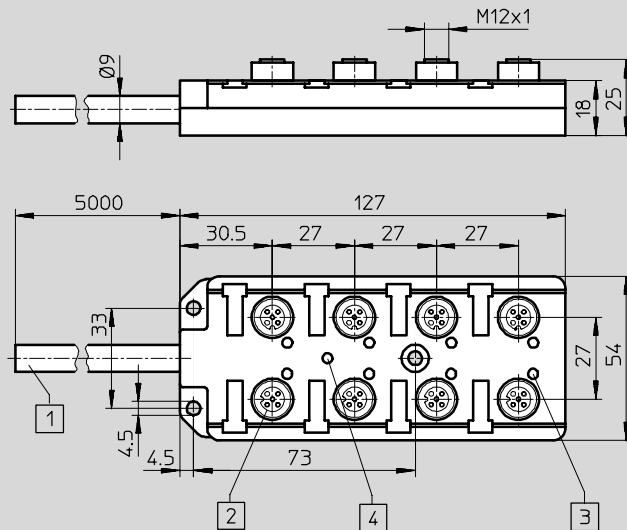

- 1 Connecting cable, 5 m
- 2 5-pin socket, M12 x 1
- 3 Switching status display, yellow
- 4 Voltage display, green

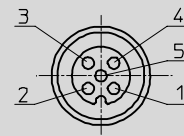

- 1 24 V DC
- 2 n.c.
- 3 0 V
- 4 Signal line (1 ... 8)
- 5 Earth

Modular electrical peripherals, for type 03/04

Technical data – Multi-pin distributor



Pin allocation			
MPV-E/A...-M8 Cable with 15-pin Sub-D plug			MPV-E/A08-M12 Signal line pins 1 through 12
	Pin No.	M8 socket location	Core colour
	1	0/4	white
	2	1/4	brown
	3	2/4	green
	4	3/4	yellow
	5	4/4	grey
	6	5/4	pink
	7	6/4	blue
	8	7/4	red
	9	8/4	black
	10	9/4	magenta
	11	10/4	grey-pink
	12	11/4	red-blue
	13	24 V DC	white-green
	14	0 V	brown-green
	15	0 V	white-yellow



Ordering data for MPV-E/A08-M12			
Designation		Type	Part No.
Plugs and cables			
	Connecting cable for sensors, M12-M12	2.5 m	KM12-M12-GSGD-2,5 18 684
		5.0 m	KM12-M12-GSGD-5 18 686
	Plug socket ¹⁾	SD-SUB-D-ST15	192 768
Protective cover			
	Cover caps (10 pieces) for unused terminals	ISK-M12	165 592

1) A Sub-D plug socket is required to establish a connection between the multi-pin distributor and input module VIGE-03-FB-16-SUBD-S.

Modular electrical peripherals, for type 03/04

Accessories – Multi-pin distributor

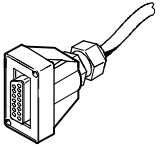
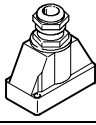
FESTO

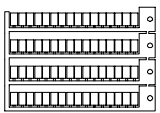
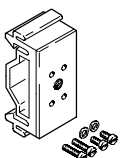
Ordering data for MPV-E/A...-M8				
Designation			Type	Part No.
Plugs and cables				
	Connecting cable for sensors, M8-M8	2.5 m	KM8-M8-GSGD-2,5	165 610
		5.0 m	KM8-M8-GSGD-5	165 611
	Plug socket with cable, open at one end ¹⁾	5.0 m	KMPV-SUB-D-15-5	177 673
		10.0 m	KMPV-SUB-D-15-10	177 674
	Plug socket ¹⁾		SD-SUB-D-ST15	192 768
Protective cover				
	Cover caps (10 pieces) for unused terminals		ISK-M8	177 672
Designation				
	Inscription labels, pack of 64		IBS-6x10	18 576
Mounting				
	Attachment for H-rail mounting, 2 pieces		CP-TS-HS-35	170 169

1) A plug socket with cable and a Sub-D plug socket are required to establish a connection between the multi-pin distributor and input module VIGE-03-FB-16-SUBD-S.

Modular electrical peripherals, for type 03/04

Technical data



Dimensions – Electrical peripherals as Remote I/O

Download CAD data → www.festo.com/en/engineering

with bus node/control block and electrical modules (max. 12 module positions)

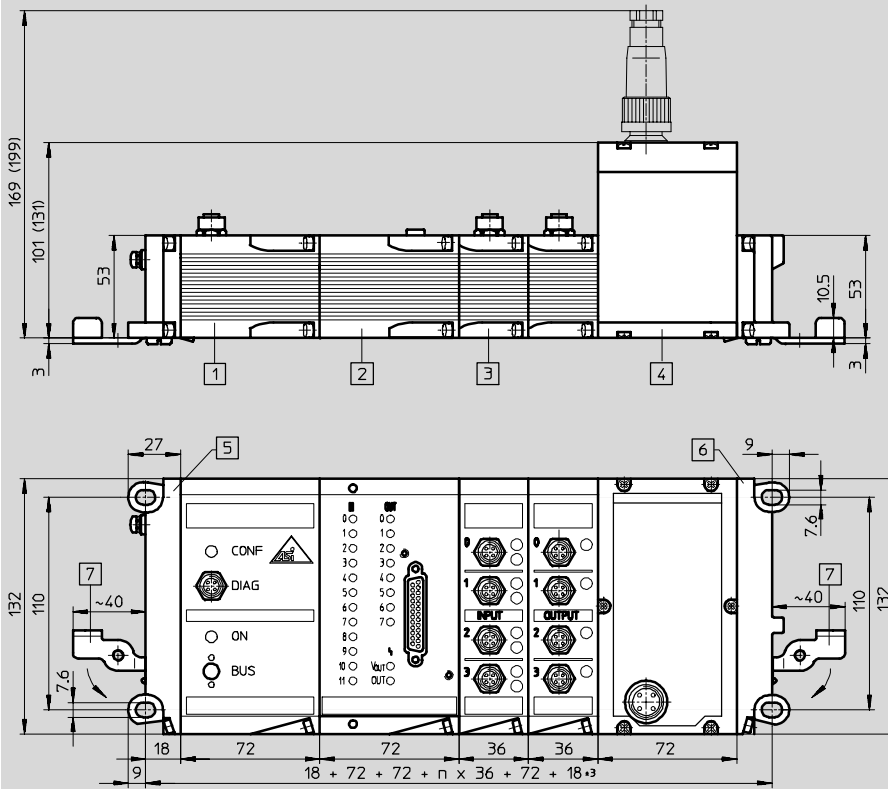

- | | | |
|------------------------------------------------|-----------------------------------------------------------------------------|-------------------------------------------------------------------------|
| 1 Electrical interface for AS-interface master | 4 Fieldbus/control block (type ISB60-03/ISF60-03-DN dimensions in brackets) | 6 End plate, right-hand |
| 2 Input/output module | 5 End plate, left-hand | 7 Swivel lever IBGH-03-4.0 (opened out) for connection to mounting rail |
| 3 Input module | | |

Modular electrical peripherals, for type 03/04

Technical data



Dimensions – Electrical peripherals with valve terminal type 03
with bus node/control block

Download CAD data → www.festo.com/en/engineering

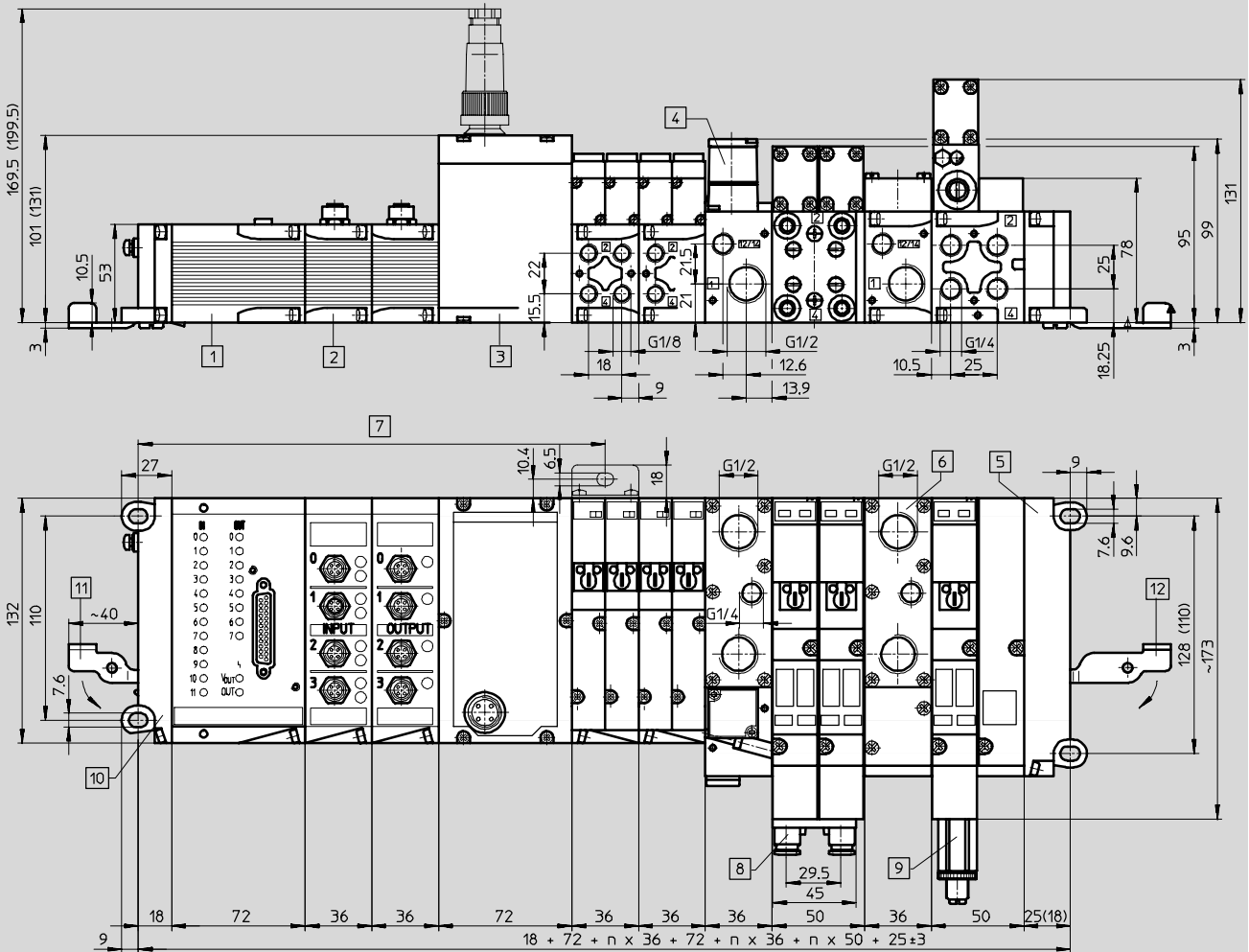

- | | | | |
|--------------------------------------------------------------------------------------------------------------------------------------------------------------------------------------|------------------------------------------------------------------------------------------------------------------------------------------------------------------------------------------------------------------------------------------------|----------------------------------------------------------------------------------------------------------------------------------------------------------------------------------------------------------------------------------|--------------------------------------------------------------------------------------------------------------------------------------------------------------------------------------------------------------|
| <ul style="list-style-type: none"> 1 Input/output module 2 Input module 3 Fieldbus/control block (type ISB60-03/ISF60-03-DN dimensions in brackets) | <ul style="list-style-type: none"> 4 Adapter plate MIDI/MAXI with pressure regulating valve for pilot pressure 5 End plate, right-hand (dimensions for MIDI valves in brackets) 6 Compressed-air supply plate | <ul style="list-style-type: none"> 7 Mounting bracket for wall mounting required approx. every 200 mm 8 One-way flow control valve 9 Pressure regulating valve 10 End plate, left-hand | <ul style="list-style-type: none"> 11 Swivel lever IBGH-03-4.0 (opened out) for connection to mounting rail 12 Swivel lever IBGH-03-7.0 (opened out) for connection to mounting rail |
|--------------------------------------------------------------------------------------------------------------------------------------------------------------------------------------|------------------------------------------------------------------------------------------------------------------------------------------------------------------------------------------------------------------------------------------------|----------------------------------------------------------------------------------------------------------------------------------------------------------------------------------------------------------------------------------|--------------------------------------------------------------------------------------------------------------------------------------------------------------------------------------------------------------|

Fieldbus systems/electrical periphery
Modular electrical terminals

Modular electrical peripherals, for type 03/04

Technical data



Dimensions – Electrical peripherals with valve terminal type 03
with DeviceNet electrical interface for 8 coils

Download CAD data → www.festo.com/en/engineering

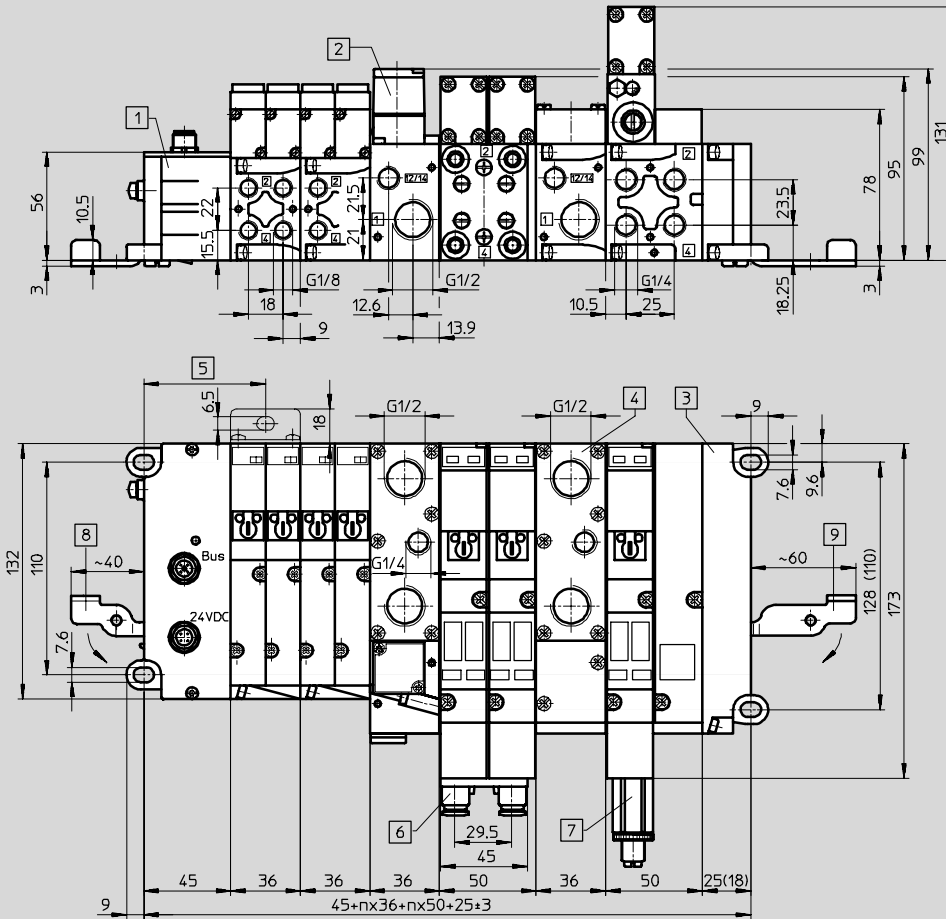

- | | | |
|-----------------------------------------------------------------------------------|--------------------------------------------------------------------------|-------------------------------------------------------------------------------|
| 1 Electrical interface VIDN-03-8A | 4 Compressed-air supply plate | 8 Swivel lever IBGH-03-4.0
(opened out) for connection to
mounting rail |
| 2 Adapter plate MIDI/MAXI with
pressure regulating valve for
pilot pressure | 5 Mounting bracket for wall
mounting required approx. every
200 mm | 9 Swivel lever IBGH-03-7.0
(opened out) for connection to
mounting rail |
| 3 End plate, right-hand (dimen-
sions for MIDI valves in brackets) | 6 One-way flow control valve | |
| | 7 Pressure regulating valve | |

Modular electrical peripherals, for type 03/04

Technical data



Dimensions – Electrical peripherals with valve terminal type 03
with AS-interface bus node for 4 coils

Download CAD data → www.festo.com/en/engineering

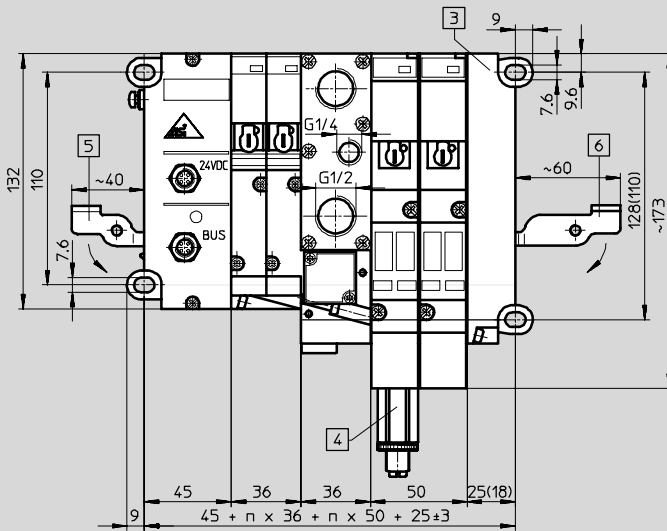
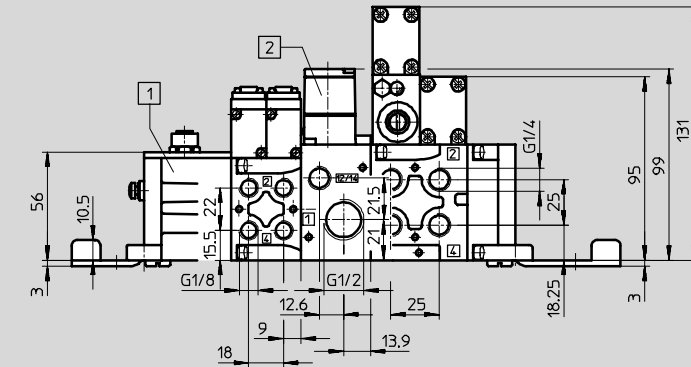

- | | |
|-----------------------------------------------------------------------------|-------------------------------------------------------------------------|
| 1 AS-interface bus node | 5 Swivel lever IBGH-03-4.0 (opened out) for connection to mounting rail |
| 2 Adapter plate MIDI/MAXI with pressure regulating valve for pilot pressure | 6 Swivel lever IBGH-03-7.0 (opened out) for connection to mounting rail |
| 3 End plate, right-hand (dimensions for MIDI valves in brackets) | |
| 4 Pressure regulating valve | |

Modular electrical peripherals, for type 03/04

Technical data



Dimensions – End plates for valve terminal 03

Download CAD data → www.festo.com/en/engineering

MIDI valves

MAXI valves

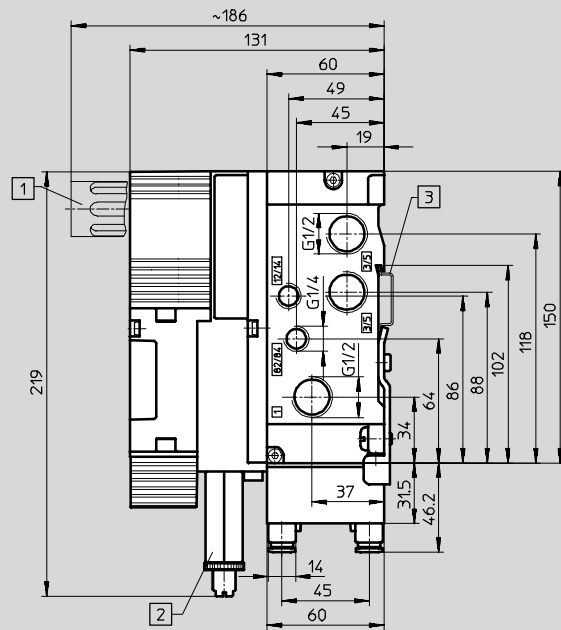
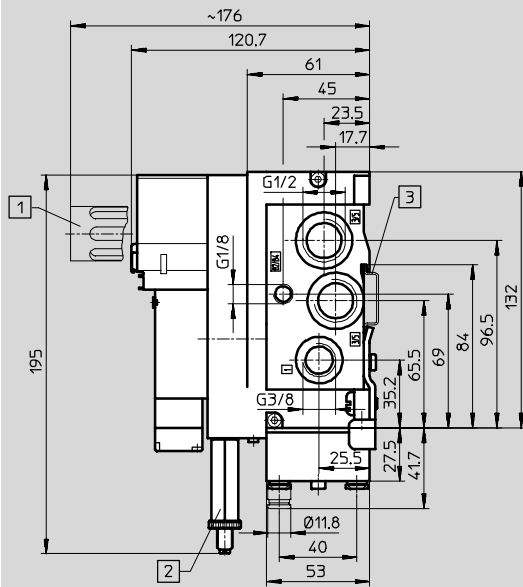

- 1 Silencer
- 2 Pressure regulating valve
- 3 H-rail

- 1 Silencer
- 2 Pressure regulating valve
- 3 H-rail

Modular electrical peripherals, for type 03/04

Technical data



Dimensions – Electrical peripherals with valve terminal type 04
with bus node/control block

Download CAD data → www.festo.com/en/engineering

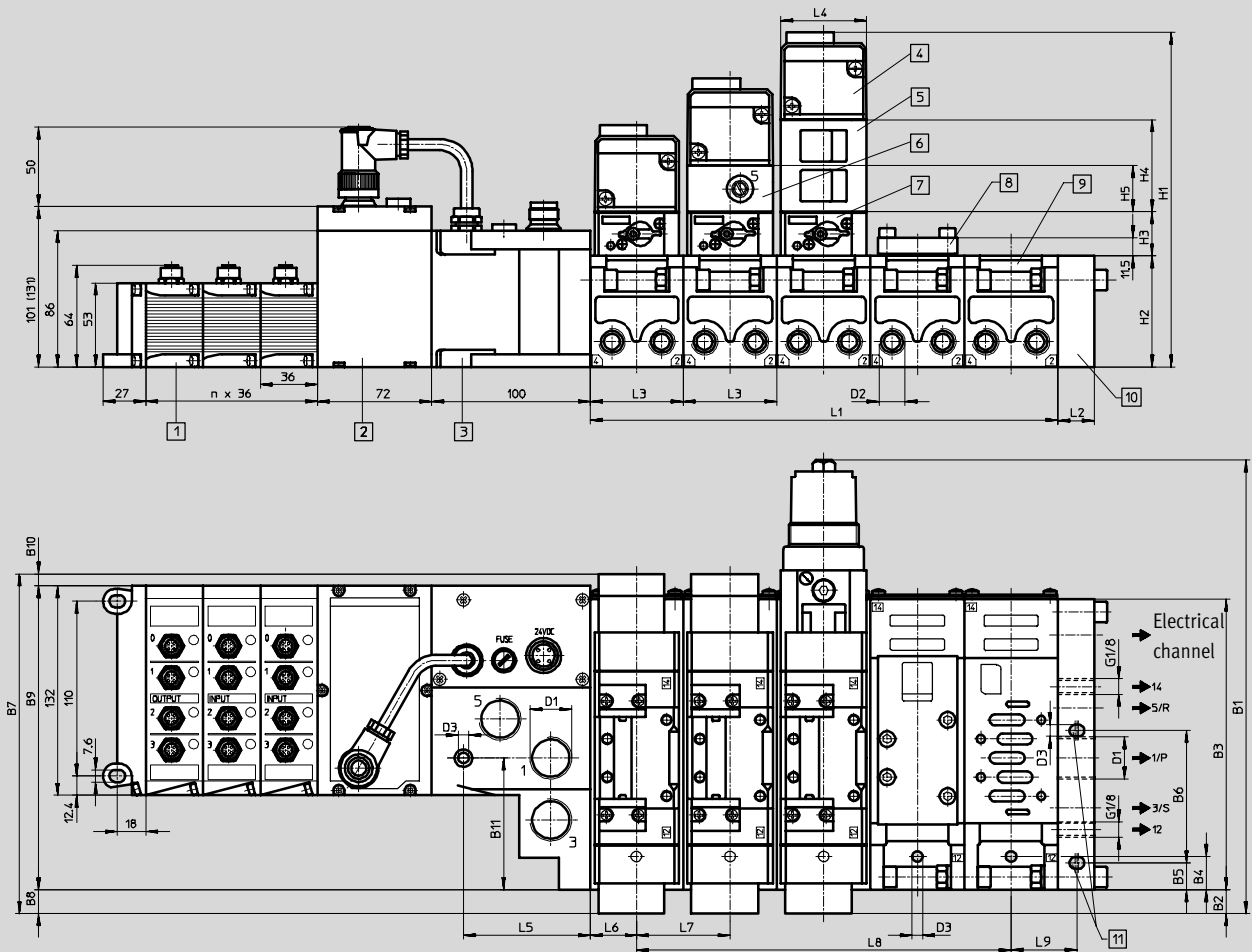

- 1 Output module
- 2 Fieldbus node (control block) type ISB60-03/ISF60-03-DN dimensions in brackets
- 3 Adapter plate
- 4 ISO valve
- 5 Intermediate pressure regulator plate
- 6 Throttle plate
- 7 Intermediate solenoid plate
- 8 Blanking plate
- 9 Manifold sub-base
- 10 End plate
- 11 Mounting hole (only with VIFB-04-D-1)

Type	~B1	B2	B3	B4	B5	B6	B7	B8	B9	B10	B11	D1	D2	D3 Ø
VIFB-04-D-1-B	251	33	149	7	17	80	198.5	33	153	12.4	56.9	G1/2	G1/4	6.6
VIFB-04-D-2-B	287	15	183	21	–	–	214	15	191.5	7.5	83	G3/4	G3/8	6.6
VIFB-04-D-3-B	315	6	230	27	–	–	241.5	6	231.6	3.9	79.5	G1	G1/2	9

Type	H1	H2	H3	H4	H5	L1 ¹⁾	L2	L3	L4	L5	L6	L7	L8 ¹⁾	L9
VIFB-04-D-1-B	181.7	64	27	45	25.5	m x 43	22	43	42	80	9.5	43	(m-1) x 43	44.5
VIFB-04-D-2-B	210.8	70	27.8	58	29	m x 59	23	59	54	80	29.5	59	(m-1) x 59	–
VIFB-04-D-3-B	235	82	28	63	40	m x 72	28	72	70	52	36	72	(m-1) x 72	–

1) m = Number of valves

Modular electrical peripherals, for type 03B

Ordering data – Modular products



M Mandatory data		O Options													
Module No.	Valve terminal, electrical part	Electrical module position 13 ... 0													
18 970	03E	Electrical inputs and outputs													
18 980		F, E, G, T, V, N, R, A, S, H, Q, Y, Z, P, U, I, M, C													
18 990		Module position													
Ordering example		13	12	11	10	9	8	7	6	5	4	3	2	1	0
18 980	03E	T	T	R	H	H	S	U	U						
1	2	3													

Ordering table					Condi- tions	Code	Enter code			
M	1	Module No.	18 970 Multi-pin connection	18 980 Fieldbus connection	18 990 Control block					
	2	Valve terminal, electrical part	Modular electrical peripherals type 03B				03E	03E		
O	3	Equipment at electrical module position 13 ... 0				1	-	-		
		Electrical module position 13 ... 0 Electrical inputs and outputs	4-fold input module, PNP, 5-pin (4-pin with MPx)					F	Enter equipment selection for module positions in order code.	
			8-fold input module, PNP, 5-pin (4-pin with MPx)					E		
			-	8-fold input module, PNP, 5-pin, 1 ms						G
			-	8-fold input module, PNP, 5-pin, fused						T
			-	4-fold input module (NPN switching)						V
			-	8-fold input module (NPN switching)						N
			-	16-fold input module with Sub-D plug, PNP						R
			-	4-fold output module, PNP, 5-pin						A
			-	Additional power supply 25 A for high-current output modules (suitable for PNP/NPN)				2		S
			-	4-fold high-current output module (4x2 A) (PNP)				3		H
			-	4-fold high-current output module (4x2 A) (NPN)				3		Q
			-	Multi I/O module, 12 inputs, 8 outputs, Sub-D (PNP)						Y
			-	Multi I/O module, 12 inputs, 8 outputs, Sub-D (NPN)						Z
			-	Analogue module for proportional valve (11/10)						P
-	Analogue module (3I, 1O) 0 ... 10 V					U				
-	Analogue module (3I, 1O), 4 ... 20 mA					I				
-	AS-i master interface				4	M				
-	-	CP interface				5	C			

1 Equipment at electrical module position 13 ... 0

The module positions must be equipped throughout.
Permissible equipment dependent on node → Tables 4 / 4.8-201.
Max. number of module positions dependent on node:
0 module positions: MP1, MP4, AS1, DN1
6 module positions: MP2
12 module positions: FB5, FB6, FB8, F11, F13, F16, F21, SF3, SB6, SF6.

2 S H, Q must be selected to the left of S, otherwise the high-current supply will be interrupted.

3 H, Q Only permissible to the left of additional power supply S.

4 M The equipment option 'M' may only be used at the extreme left. Selecting 'M' completes configuration of the electrical part. Not with node FB5, FB8, F11.

5 C Only at the extreme right after the node.

6 MP1, MP4, AS1, DN1
No electrical inputs/outputs

7 MP2 Only electrical inputs E, F permitted.

Transfer order code																
1	2	3	13	12	11	10	9	8	7	6	5	4	3	2	1	0

Modular electrical peripherals, for type 03B

Ordering data – Modular products



M Mandatory data →

Electrical connection

MP1, MP2, MP4, FB5, FB6, FB8, F11, F13, F16, F21, AS1, DN1, SF3, SB6, SF6

– **F21**

4

Ordering table

Module No.	18 970 Multi-pin connection	18 980 Fieldbus connection	18 990 Control block	Condi- tions	Code	Enter code
4	Basic configuration (node)					
M	Electrical connection	Multi-pin connection via round connector	–	–	6	MP1
	Multi-pin connection via round connector, with inputs	–	–	–	7	MP2
	Multi-pin connection via Sub-D plug	–	–	–	6	MP4
	–	Fieldbus protocol Festo, ABB (CS31), Moeller SUCONET K	–	–	–	FB5
	–	Fieldbus protocol INTERBUS	–	–	–	FB6
	–	Fieldbus protocol Allen Bradley (1771 RIO)	–	–	–	FB8
	–	Fieldbus protocol DeviceNet, Phillips DIOS, SELECAN	–	–	–	F11
	–	Fieldbus protocol PROFIBUS DP, 12 MBd	–	–	–	F13
	–	Fieldbus protocol ASA (FIPIO)	–	–	–	F16
	–	Fieldbus protocol INTERBUS with FOC	–	–	–	F21
	–	Fieldbus protocol AS-interface slave for 4 coils - 2 - To be discontinued	–	–	6	AS1
	–	Fieldbus protocol DeviceNet interface for 8 coils	–	–	6	DN1
	–	–	Control block SF 3 with Festo fieldbus	–	–	SF3
	–	–	Control block SB 60 (SLC embedded)	–	–	SB6
	–	–	Control block SB 60 (SLC embedded) with DeviceNet	–	–	SF6

Fieldbus systems/electrical periphery
Modular electrical terminals

4.8

Transfer order code

4

Modular electrical peripherals, for type 03B

Ordering data – Modular products



Options

Accessories supplied loose

...Y, ...Q, ...N, ...M, ...I, ...S, ...P, ...X, ...K, ...W, A, Z, T, U, F, G, V, D, ...H, ...J, ...E, B

+ 16K

5

Ordering table							
Module No.		18 970 Multi-pin connection	18 980 Fieldbus connection	18 990 Control block	Condi- tions	Code	Enter code
5	Accessories supplied loose					+	+
0	Multi-pin plug socket valves	1	–	–		...Y	
	round, straight socket for inputs	1	–	–		...Q	
	Power supply socket, 1.5 mm ²	–	1			...N	
	straight, M18, for 2.5 mm ²	–	1			...M	
	Power supply socket, 1.5 mm ²	–	1			...I	
	angled, M18, for						
	Sensor plug, straight, 4-pin	1 ... 99			8	...S	
	M12, Pg7 5-pin	–	1 ... 99		8	...P	
	DUO plug M12 for 4-pin	1 ... 99			8	...X	
	2 cables, Pg11 5-pin	–	1 ... 99		8	...K	
	Sensor plug M12 for 4-pin	1 ... 99			8	...W	
	cable with OD 2.5 mm						
	Connection socket for fieldbus	–	Connection socket, moulded cable, AS-interface	–	9	A	
		–	2 connection sockets, straight, Pg7			Z	
		–	2 connection sockets, straight, Pg9			T	
		–	2 connection sockets, straight, Pg13.5			U	
		–	2 connection sockets, angled, Pg7			F	
		–	2 connection sockets, angled, Pg9			G	
		–	Sub-D fieldbus connector for PROFIBUS DP	–		V	
		–	Connection socket, straight, Pg9, 5-pin		10	D	
	Connecting cable, 5 m	1 ... 99			11	...H	
	Sub-D, 25-core 10 m	1 ... 99			11	...J	
	Plug socket Sub-D, IP65 25-pin	1 ... 99			11	...E	
	User documentation	–	Express waiver - no manual to be included (already available)			B	

8 S, P, X, K, W Only permissible if at least one of the electrical equipment options E, F, G, T, A, H, V, N, Q is selected.

9 A Only with electrical connection AS1.

10 D Only with electrical connection F11, DN1, SF6.

11 H, J, E Only permissible if at least one of the electrical equipment options Z, Y or the electrical connection MP4 is selected.

Transfer order code

+

5

Modular electrical peripherals, for type 04B

Ordering data – Modular products



Mandatory data →

Module No.	Valve terminal, type 04B, electrical part	Electrical connection
18 923 18 924 18 925	04E	FB5, FB6, FB8, F11, F13, SB6, SF6
Ordering example		
1	2	3
	04E	- F11

Ordering table

Size	ISO 1	ISO 2	ISO 3	Condi- tions	Code	Enter code
M 1	18 923	18 924	18 925			
2	Valve terminal, electrical part				04E	04E
3	Basic configuration			1	-	-
	Electrical connection				FB5	
					FB6	
					FB8	
					F11	
					F13	
					F16	
					SB6	
					SF6	

1 Basic configuration, electrical connection

Note permissible number of digital and analogue connections → Tables 4 / 4.8-201.

Transfer order code

1		2	04E	-		3
---	--	---	------------	---	--	---

Modular electrical peripherals, for type 04B

Ordering data – Modular products



M Mandatory data														
Electrical module position 13 ... 0														
Electrical input and output modules														
F, E, G, T, V, N, R, A, S, H, Q, Y, Z, P, U, I, M, C														
Module position														
	13	12	11	10	9	8	7	6	5	4	3	2	1	0
-	Y	Y	N	N	F	F	E							
	4													

Ordering table							
Size	ISO 1	ISO 2	ISO 3	Condi- tions	Code	Enter code	
4	Equipment at electrical module position 13 ... 0			2	-	-	
M	Electrical module position 13 ... 0				F	Enter equip- ment selection for module positions in order code.	
	Electrical input and output modules				E		
	8-fold input module, PNP, 5-pin				G		
	4-fold input module, PNP, 5-pin				T		
	8-fold input module, PNP, 5-pin, 1 ms				V		
	8-fold input module, PNP, 5-pin, fused				N		
	4-fold input module (NPN switching)				R		
	8-fold input module (NPN switching)				A		
	16-fold input module with Sub-D plug, PNP				S		
	4-fold output module, PNP, 5-pin			3			
	Additional power supply 25 A for high-current output modules (suitable for PNP/NPN)			4	H		
	4-fold high-current output module (4x2 A) (PNP)			4	Q		
	4-fold high-current output module (4x2 A) (NPN)				Y		
	Multi I/O module, 12 inputs, 8 outputs, Sub-D (PNP)				Z		
	Multi I/O module, 12 inputs, 8 outputs, Sub-D (NPN)			5	P		
	Analogue module for proportional valve (1I/1O)			5	U		
	Analogue module (3I, 1O) 0 ... 10 V			5	I		
Analogue module (3I, 1O), 4 ... 20 mA			6	M			
AS-i master interface			7	C			
CP interface							

2 Equipment at electrical module position 13 ... 0

The module positions must be equipped throughout from right to left without exception.

Permissible equipment dependent on node → Tables 4 / 4.8-201.

Max. number of module positions dependent on node:

12 module positions: FB5, FB6, FB8, F11, F13, F16, F21, SF3, SB6, SF6.

3 S High-current output module H or Q must be selected immediately after S, otherwise the high-current supply will be interrupted.

4 H, Q Only permissible to the left of additional power supply S.

5 P, U, I

Not in combination with electrical connection FB5, FB8 and F16.

6 M

The equipment option 'M' may only be used at the extreme left. Selecting 'M' completes configuration of the electrical part.

Not with electrical connection FB5, FB8, F11, F16.

7 C

Only at the extreme right after the node.

Only with electrical connection SB6, SF6.

Transfer order code

	13	12	11	10	9	8	7	6	5	4	3	2	1	0
-														
	4													

Modular electrical peripherals, for type 04B

Ordering data – Modular products



0 Options

Accessories supplied loose

...N, ...M, ...I, ...S, ...W, ...P, ...X, ...K, Z, T, U, F, G, V, D, ...H, ...J, ...E, B

+ 5P8K

5

Ordering table		ISO 1	ISO 2	ISO 3	Condi- tions	Code	Enter code
5	Accessories supplied loose					+	+
0	Power supply socket, 1.5 mm ²	1				...N	
	straight, M18, for 2.5 mm ²	1				...M	
	Power supply socket, 1.5 mm ²	1				...I	
	angled, M18, for						
	Sensor plug, straight, 4-pin	1 ... 99			8	...S	
	M12, Pg7	5-pin	1 ... 99		8	...P	
	DUO plug M12 for 4-pin	1 ... 99			8	...X	
	2 cables, Pg11	5-pin	1 ... 99		8	...K	
	Sensor plug M12 for 4-pin	1 ... 99			8	...W	
	cable with OD 2.5 mm						
	Connection socket for fieldbus	2 connection sockets, straight, Pg7			9	Z	
		2 connection sockets, straight, Pg9			9	T	
		2 connection sockets, straight, Pg13.5			9	U	
		2 connection sockets, angled, Pg7			9	F	
		2 connection sockets, angled, Pg9			9	G	
		Sub-D fieldbus connector for PROFIBUS DP			10	V	
		Connection socket, straight, Pg9, 5-pin			11	D	
	Connecting cable, 5 m	1 ... 99			12	...H	
	Sub-D, 25-core	10 m	1 ... 99		12	...J	
	Plug socket Sub-D, IP65	25-pin	1 ... 99		12	...E	
	User documentation	Express waiver - no manual to be included (already available)				B	

8 **S, P, X, K, W** Only permissible if at least one of the electrical equipment options E, F, G, T, A, H, V, N, Q is selected.

11 **D** Only with electrical connection F11, SF6.

9 **Z, T, U, F, G** Only with electrical connection FB5, FB8 or F16.

12 **H, J, E** Only permissible if at least one of the electrical equipment options Z, Y is selected.

10 **V** Only with electrical connection F13.

Transfer order code

+

5

Modular electrical peripherals, for type 03B/04B



Ordering data – Modular products

Number of digital and analogue connections															
Modular electrical peripherals	MP1	MP2	MP4	FB5	FB6	FB8	F11	F13	F16	F21	AS1	DN1	SF3	SB6	SF6
Digital inputs	0	24	0	60	60	60	60	96	60	96	0	0	128	128	128
Digital outputs	24	24	22	64	64	64	64	74	64	74	4	8	128	128	128
Analogue inputs	0	0	0	–	8	–	8	12	0	8	0	0	36	9	9
Analogue outputs	0	0	0	–	8	–	8	12	0	8	0	0	12	9	9
Analogue lines	0	0	0	–	16	–	16	12	0	16	0	0	48	18	18
Number of module positions	0	6	0	14	14	14	14	14	14	14	0	0	14	14	14

Usage via equipment options																		
Electrical inputs and outputs	E	F	G	T	A	H	Y	R	V	N	Q	Z	P	U	I	M	S	C
Digital inputs	8	4	8	8	0	0	12	16	4	8	0	12	–	–	–	64	0	0
Digital outputs	0	0	0	0	4	4	8	0	0	0	4	8	–	–	–	64	0	0
Analogue inputs	–	–	–	–	–	–	–	–	–	–	–	–	1	3	3	–	–	–
Analogue outputs	–	–	–	–	–	–	–	–	–	–	–	–	1	1	1	–	–	–
Analogue lines	–	–	–	–	–	–	–	–	–	–	–	–	2	4	4	–	–	–
Number of module positions	1	1	1	1	1	1	3	2	1	1	1	3	1	1	1	1	0	1

Modular electrical peripherals, for type 03/04

Accessories

Product range overview – Connections for bus nodes								
Designation	Type	FB5	FB6	FB8	F11	F13	F16	F21
Fieldbus connection								
Bus connection, straight, PG7	FBSD-GD-7	■	-	■	-	-	■	-
Bus connection, straight, PG9	FBSD-GD-9	■	-	■	-	-	■	-
Bus connection, straight, PG9, 5-pin	FBSD-GD-9-5POL	-	-	-	■	-	-	-
Bus connection, straight, PG13.5	FBSD-GD-13,5	■	-	■	-	-	■	-
Bus connection, angled, PG7	FBSD-WD-7	■	-	■	-	-	■	-
Bus connection, angled, PG9	FBSD-WD-9	■	-	■	-	-	■	-
Plug, Sub-D	FBS-SUB-9-GS-9	-	-	-	-	■	-	-
Plug, Sub-D	FBS-SUB-9-GS-DP-B	-	-	-	-	■	-	-
Bus connection, 2x M12 adapter plug (B-coded)	FBA-2-M12-5POL-RK	-	-	-	-	■	-	-
Plug, straight, 5-pin for T-adapter	FBS-M12-5GS-PG9	-	-	-	-	-	-	-
T-adapter for DH-485	FB-TA-M12-5POL	-	-	-	-	-	-	-
T-adapter for fieldbus, with pre-assembled socket component	FB-TA	■	-	■	-	-	■	-
T-adapter for fieldbus, with free cable end	FB-TA1	■	-	■	-	-	■	-
Interbus standard round plug ¹⁾		-	■	-	-	-	-	-
Interbus "Rugged Line" FOC plug ¹⁾		-	-	-	-	-	-	■
Power supply								
Plug socket, straight, for 1.5 mm ²	NTSD-GD-9	■	■	■	■	■	■	-
Plug socket, straight, for 2.5 mm ²	NTSD-GD-13,5	■	■	■	■	■	■	-
Plug socket, angled, for 1.5 mm ²	NTSD-WD-9	■	■	■	■	■	■	-
Plug socket, angled, for 2.5 mm ²	NTSD-WD-11	■	■	■	■	■	■	-

1) Not a Festo product, order from Phoenix Contact

Modular electrical peripherals, for type 03/04

Accessories

Product range overview – Connections for DeviceNet electrical interface, AS-interface bus node and control blocks						
Designation	Type	DN1	AS1	SB6	SF6	SF3
Fieldbus connection						
Bus connection, straight, PG7	FBSD-GD-7	-	-	-	-	■
Bus connection, straight, PG9	FBSD-GD-9	-	-	-	-	■
Bus connection, straight, PG9, 5-pin	FBSD-GD-9-5POL	■	-	■	■	-
Bus connection, straight, PG13.5	FBSD-GD-13,5	-	-	-	-	■
Bus connection, angled, PG7	FBSD-WD-7	-	-	-	-	■
Bus connection, angled, PG9	FBSD-WD-9	-	-	-	-	■
Plug, Sub-D	FBS-SUB-9-GS-9	-	-	-	-	-
Plug, Sub-D	FBS-SUB-9-GS-DP-B	-	-	-	-	-
Bus connection, 2x M12 adapter plug (B-coded)	FBA-2-M12-5POL-RK	-	-	-	-	-
Plug, straight, 5-pin for T-adapter	FBS-M12-5GS-PG9	-	-	■	■	-
T-adapter for DH-485	FB-TA-M12-5POL	-	-	■	■	-
T-adapter for fieldbus, with pre-assembled socket component	FB-TA	-	-	-	-	-
T-adapter for fieldbus, with free cable end	FB-TA1	-	-	-	-	-
Interbus standard round plug ¹⁾		-	-	-	-	-
Interbus "Rugged Line" FOC plug ¹⁾		-	-	-	-	-
Power supply						
Plug socket, straight, for 1.5 mm ²	NTSD-GD-9	-	-	■	■	■
Plug socket, straight, for 2.5 mm ²	NTSD-GD-13,5	-	-	■	■	■
Plug socket, angled, for 1.5 mm ²	NTSD-WD-9	-	-	■	■	■
Plug socket, angled, for 2.5 mm ²	NTSD-WD-11	-	-	■	■	■
Plug socket, straight, PG7	FBSD-GD-7	■	■	-	-	-
Plug socket, straight, PG9	FBSD-GD-9	■	■	-	-	-
Plug socket, angled, PG7	FBSD-WD-7	■	■	-	-	-
Plug socket, angled, PG9	FBSD-WD-9	■	■	-	-	-
Diagnostic/data connection						
Programming cables	KDI-SB202-BU9	-	-	-	-	■
Programming cable, 3 m	KDI-SB60-3,0-M12	-	-	■	■	-
Programming cable, 6 m	KDI-SB60-6,0-M12	-	-	■	■	-
Programming cable, 10 m	KDI-SB60-10,0-M12	-	-	■	■	-
Cable for DTAM Micro, 3 m	KDTAM-SB60-3-M12	-	-	■	■	-
Cable for DTAM Micro, 6 m	KDTAM-SB60-6-M12	-	-	■	■	-
Cable for DTAM Micro, 10 m	KDTAM-SB60-10-M12	-	-	■	■	-
AS-interface						
Combi power pack	ASI-CNT-115/230AC-B	-	■	-	-	-
Cable distributor, cable parallel rotatable	ASI-KVT-FK	-	■	-	-	-
Cable distributor, cable symmetrical	ASI-KVT-FK-S	-	■	-	-	-
Flat cable (standard cable, yellow)	KASI-1,5-Y-100	-	■	-	-	-
Flat cable (additional power supply, black)	KASI-1,5-Z-100	-	■	-	-	-
Cable socket for bus and voltage supply connection, M12, flat	ASI-SD-FK-M12	-	■	-	-	-
Cable socket for bus and voltage supply connection, M12, PG13.5	ASI-SD-PG-M12	-	■	-	-	-
AS-interface configuration plug	ASI-SS-CONFIG	-	-	-	-	-

1) Not a Festo product, order from Phoenix Contact

Modular electrical peripherals, for type 03/04

Accessories



Product range overview – Electrical connection technology for modules					
Designation	Type	Input module		Output module	Input/output module
		4-/8-fold VIGE-...	16-fold VIGE-...	VIGA-...	VIEA-...
Plugs and sockets					
Plug, straight socket, M12, 4-pin, PG7	SEA-GS-7	■	-	■	-
Plug, straight socket, M12, 4-pin, 2.5 mm ² OD	SEA-4GS-7-2,5	■	-	■	-
Plug, straight socket, M12, 5-pin, PG7	SEA-M12-5GS-PG7	■	-	■	-
Plug for 2 sensor cables, M12, PG11, 4-pin	SEA-GS-11-DUO	■	-	■	-
Plug for 2 sensor cables, M12, PG11, 5-pin	SEA-5GS-11-DUO	■	-	■	-
Plug socket Sub-D, plug	SD-SUB-D-ST15	-	■	-	-
Plug socket Sub-D, socket	SD-SUB-D-BU25	-	-	-	■
Cables					
Programming cable for AS-interface software tool, serial	KDI-SB202-BU9	-	-	-	-
Connecting cable, 5 m	KEA-1-25P-5	-	-	-	■
Connecting cable, 10 m	KEA-1-25P-10	-	-	-	■
Connecting cable, x length	KEA-1-25P-X	-	-	-	■
DUO cable, 2x straight socket	KM12-DUO-M8-GDGD	■	-	■	-
DUO cable, 2x straight/angled socket	KM12-DUO-M8-GDWD	■	-	■	-
DUO cable, 2x angled socket	KM12-DUO-M8-WDWD	■	-	■	-
Plug socket with cable, open at one end, 5 m	KMPV-SUB-D-15-5	-	■	-	-
Plug socket with cable, open at one end, 10 m	KMPV-SUB-D-15-10	-	■	-	-
Connecting cable, straight plug, angled socket, 5 m	KVI-CP-1-GS-WD-5	-	-	-	-
Connecting cable, straight plug, angled socket, 8 m	KVI-CP-1-GS-WD-8	-	-	-	-
Connecting cable, angled plug, angled socket, 0.5 m	KVI-CP-1-WS-WD-0,5	-	-	-	-
Connecting cable, angled plug, angled socket, 2 m	KVI-CP-1-WS-WD-2	-	-	-	-
Connecting cable, angled plug, angled socket, 5 m	KVI-CP-1-WS-WD-5	-	-	-	-
Connecting cable, straight plug, straight socket, 2 m	KVI-CP-2-GS-GD-2	-	-	-	-
Connecting cable, straight plug, straight socket, 5 m	KVI-CP-2-GS-GD-5	-	-	-	-
Connecting cable, straight plug, straight socket, 8 m	KVI-CP-2-GS-GD-8	-	-	-	-
Connecting cable for Festo proportional pressure regulator, 5 m	KVIA-MPPE-5	-	-	-	-
Connecting cable for Festo proportional pressure regulator, 10 m	KVIA-MPPE-10	-	-	-	-
Connecting cable for Festo proportional directional control valve, 5 m	KVIA-MPYE-5	-	-	-	-
Connecting cable for Festo proportional directional control valve, 10 m	KVIA-MPYE-10	-	-	-	-
Connecting cable for other signal modules, open cable end, 5 m	KVIA-5	-	-	-	-
Connecting cable for other signal modules, open cable end, 10 m	KVIA-10	-	-	-	-
AS-interface					
Combi power pack	ASI-CNT-115/230AC-B	-	-	-	-
Cable distributor, cable parallel rotatable	ASI-KVT-FK	-	-	-	-
Cable distributor, cable symmetrical	ASI-KVT-FK-S	-	-	-	-
Flat cable (standard cable, yellow)	KASI-1,5-Y-100	-	-	-	-
Flat cable (additional power supply, black)	KASI-1,5-Z-100	-	-	-	-
Cable socket for bus and voltage supply connection, M12, flat	ASI-SD-FK-M12	-	-	-	-
Cable socket for bus and voltage supply connection, M12, PG13.5	ASI-SD-PG-M12	-	-	-	-
AS-interface configuration plug	ASI-SS-CONFIG	-	-	-	-

Modular electrical peripherals, for type 03/04

Accessories

FESTO

Product range overview – Electrical connection technology for modules					
Designation	Type	Analogue stage		Electrical interface	
		VIAP-...	VIAU-...	VIGCP-...	VIASI-...
Plugs and sockets					
Plug, straight socket, M12, 4-pin, PG7	SEA-GS-7	-	-	-	-
Plug, straight socket, M12, 4-pin, 2.5 mm ² OD	SEA-4GS-7-2,5	-	-	-	-
Plug, straight socket, M12, 5-pin, PG7	SEA-M12-5GS-PG7	-	-	-	-
Plug for 2 sensor cables, M12, PG11, 4-pin	SEA-GS-11-DUO	-	-	-	-
Plug for 2 sensor cables, M12, PG11, 5-pin	SEA-5GS-11-DUO	-	-	-	-
Plug socket Sub-D, plug	SD-SUB-D-ST15	-	-	-	-
Plug socket Sub-D, socket	SD-SUB-D-BU25	-	-	-	-
Cables					
Programming cable for AS-interface software tool, serial	KDI-SB202-BU9	-	-	-	■
Connecting cable, 5 m	KEA-1-25P-5	-	-	-	-
Connecting cable, 10 m	KEA-1-25P-10	-	-	-	-
Connecting cable, x length	KEA-1-25P-X	-	-	-	-
DUO cable, 2x straight socket	KM12-DUO-M8-GDGD	-	-	-	-
DUO cable, 2x straight/angled socket	KM12-DUO-M8-GDWD	-	-	-	-
DUO cable, 2x angled socket	KM12-DUO-M8-WDWD	-	-	-	-
Plug socket with cable, open at one end, 5 m	KMPV-SUB-D-15-5	-	-	-	-
Plug socket with cable, open at one end, 10 m	KMPV-SUB-D-15-10	-	-	-	-
Connecting cable, straight plug, angled socket, 5 m	KVI-CP-1-GS-WD-5	-	-	■	-
Connecting cable, straight plug, angled socket, 8 m	KVI-CP-1-GS-WD-8	-	-	■	-
Connecting cable, angled plug, angled socket, 0.5 m	KVI-CP-1-WS-WD-0,5	-	-	■	-
Connecting cable, angled plug, angled socket, 2 m	KVI-CP-1-WS-WD-2	-	-	■	-
Connecting cable, angled plug, angled socket, 5 m	KVI-CP-1-WS-WD-5	-	-	■	-
Connecting cable, straight plug, straight socket, 2 m	KVI-CP-2-GS-GD-2	-	-	■	-
Connecting cable, straight plug, straight socket, 5 m	KVI-CP-2-GS-GD-5	-	-	■	-
Connecting cable, straight plug, straight socket, 8 m	KVI-CP-2-GS-GD-8	-	-	■	-
Connecting cable for Festo proportional pressure regulator, 5 m	KVIA-MPPE-5	■	■	-	-
Connecting cable for Festo proportional pressure regulator, 10 m	KVIA-MPPE-10	■	■	-	-
Connecting cable for Festo proportional directional control valve, 5 m	KVIA-MPYE-5	■	■	-	-
Connecting cable for Festo proportional directional control valve, 10 m	KVIA-MPYE-10	■	■	-	-
Connecting cable for other signal modules, open cable end, 5 m	KVIA-5	■	■	-	-
Connecting cable for other signal modules, open cable end, 10 m	KVIA-10	■	■	-	-
AS-interface					
Combi power pack	ASI-CNT-115/230AC-B	-	-	-	■
Cable distributor, cable parallel rotatable	ASI-KVT-FK	-	-	-	■
Cable distributor, cable symmetrical	ASI-KVT-FK-S	-	-	-	■
Flat cable (standard cable, yellow)	KASI-1,5-Y-100	-	-	-	■
Flat cable (additional power supply, black)	KASI-1,5-Z-100	-	-	-	■
Cable socket for bus and voltage supply connection, M12, flat	ASI-SD-FK-M12	-	-	-	■
Cable socket for bus and voltage supply connection, M12, PG13.5	ASI-SD-PG-M12	-	-	-	■
AS-interface configuration plug	ASI-SS-CONFIG	-	-	-	■







Fieldbus systems/electrical periphery
Modular electrical terminals

4.8

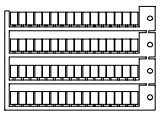
Modular electrical peripherals, for type 03/04

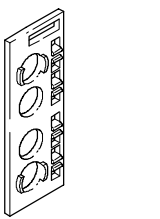
FESTO

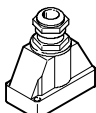

Accessories

Ordering data			
Designation		Type	Part No.
Inscription labels and label holders			
	Inscription labels, 6x10, 64 pieces in frames	IBS-6x10	18 576
	Inscription labels, 9x20, 20 pieces in frames	IBS-9x20	18 182
	Holders for inscription labels for I/O modules, pack of 5	IBT-03-E/A	18 183
Plugs, sockets and accessories			
	Bus connection, straight, PG9, 5-pin	FBSD-GD-9-5POL	18 324
	Plug, straight, 5-pin for T-adapter	FBS-M12-5GS-PG9	175 380
	T-adapter	for DH-485	FB-TA-M12-5POL 171 175
		for fieldbus	FB-TA 18 498
	Plug socket Sub-D, plug	SD-SUB-D-ST15	192 768
	Screw-type lock for standard Sub-D, 1 piece	UNC 4-40/M3x5	340 960

Modular electrical peripherals, for type 03/04

Accessories

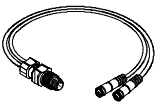

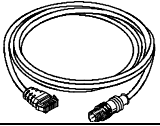
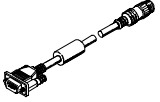
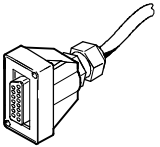







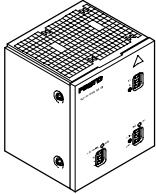

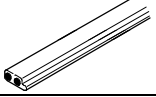
Ordering data				
Designation			Type	Part No.
Cables				
	DUO cable	2x straight socket	KM12-DUO-M8-GDGD	18 685
		2x straight/angled socket	KM12-DUO-M8-GDWD	18 688
		2x angled socket	KM12-DUO-M8-WDWD	18 687
	Connecting cable for sensors, M12-M12	2.5 m	KM12-M12-GSGD-2,5	18 684
		5.0 m	KM12-M12-GSGD-5	18 686
	Connecting cable for sensors, M8-M8	2.5 m	KM8-M8-GSGD-2,5	165 610
		5.0 m	KM8-M8-GSGD-5	165 611
	Programming cable	3 m	KDI-SB60-3,0-M12	171 173
		6 m	KDI-SB60-6,0-M12	175 686
		10 m	KDI-SB60-10,0-M12	171 174
	Programming cable		KDI-SB202-BU9	150 268
	Cable for DTAM Micro	3 m	KDTAM-SB60-3-M12	188 979
		6 m	KDTAM-SB60-6-M12	188 980
		10 m	KDTAM-SB60-10-M12	188 981
	Plug socket with cable, open at one end	5.0 m	KMPV-SUB-D-15-5	177 673
		10.0 m	KMPV-SUB-D-15-10	177 674

Modular electrical peripherals, for type 03/04

FESTO

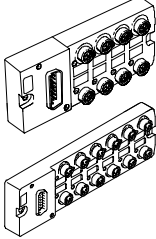
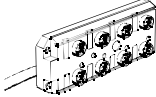
Accessories

Ordering data				
Designation	Type	Part No.		
AS-Interface				
	Combi power pack	ASI-CNT-115/230AC-B	191 082	
	Cable distributor, cable parallel rotatable	ASI-KVT-FK	18 786	
	Cable distributor, cable symmetrical	ASI-KVT-FK-S	18 797	
	Flat cable (standard cable, yellow)	KASI-1,5-Y-100	18 940	
	Flat cable (additional power supply, black)	KASI-1,5-Z-100	18 941	
	AS-interface configuration plug	ASI-SS-CONFIG	18 961	
	Cable socket for bus and voltage supply connection, M12, flat	ASI-SD-FK-M12	18 788	
	Cable socket for bus and voltage supply connection, M12, PG13.5	ASI-SD-PG-M12	18 789	
	Cable socket, flat	ASI-SD-FK	18 785	
	Cable socket, flat, cable rotated 180° (upside-down)	ASI-SD-FK180	196 089	
Multi-pin distributors				
	Multi-pin distributor, 3-pin M8 plug	8 I/Os	MPV-E/A08-M8	177 669
		12 I/Os	MPV-E/A12-M8	177 670
	Multi-pin distributor with connecting cable, 5-pin M12 plug	8 I/Os	MPV-E/A08-M12	177 671
Programming software				
	Programming software FST200 with manual for control block ISF3-03	German	P.BE-FST200-AWL/KOP-DE	165 484
		English	P.BE-FST200-AWL/KOP-EN	165 489

Fieldbus systems/electrical periphery
Modular electrical terminals

4.8